

Motor controllers CMMS-AS, for servo motors



**- I - Type discontinued**  
**Available up until 2016**

**FESTO**

## Motor controllers CMMS-AS, for servo motors

Key features

Comparison of motor controllers				
Motor controller for motor type	CMMD-AS Servo motor	CMMS-AS Servo motor	CMMP-AS Servo motor	CMMS-ST Stepper motor
Positioning records	2x 63	63	255	63
Measuring system	Incremental/absolute		Analogue/incremental/absolute	Incremental
Extended I/O interface	4 working modes		Flexibly configurable	4 working modes
Notification of remaining distance	1 for n		Separately for all positions	1 for n
Torque reduction	No		Separately for all positions	No
Set linking	Linear		With branching	Linear
Safety functions to EN 61800-5-2	STO, SS1 (with external safety switching device)		STO, SS1, SBC, SOS, SS2, SLS, SSR, SSM	STO, SS1 (with external safety switching device)

### Performance characteristics

#### Compactness

- Small dimensions
- Full integration of all components for controller and power section, including RS232 and CANopen interface
- Integrated brake chopper
- Integrated EMC filters

- Automatic actuation for a holding brake
- Adheres to the current CE and EN standards without additional external measures (motor cable length of up to 15 m)

#### Motion control

- Digital absolute shaft encoder in single-turn and multi-turn versions
- Can be operated as a torque, speed or position controller
- Integrated positioning controller
- Time-optimised (trapezoidal) or jerk-free (S-shaped) positioning
- Absolute and relative movements

- Point-to-point positioning with and without approximate positioning
- Position synchronisation
- Electronic gear unit
- 63 position sets
- 8 travel profiles
- Wide range of homing methods

#### Fieldbus interfaces

Integrated:

**CANopen**

Optional:

**PROFIBUS**

**DeviceNet**

#### Input/output

- Freely programmable I/Os
- High-resolution 12-bit analogue input
- Jog/teach mode
- Simple linking to a higher-level controller via I/O or fieldbus
- Synchronous operation
- Master/slave mode

#### Integrated sequence control

- Automatic sequence of position sets without a higher-level controller
- Linear and cyclic position sequences
- Adjustable delay times

PROFIBUS®, DeviceNet®, CANopen® is a registered trademark of its respective trademark holder in certain countries.

## Motor controllers CMMS-AS, for servo motors

Key features

### Performance characteristics

#### Integrated safety functions

- The motor controller CMMS-AS support "Safe Torque off (STO)" and, by providing a reliable time delay, also supports "Safe Stop 1 (SS1)" functions with protection against unexpected startup in accordance with EN 61800-5-2
- Protection against unexpected start-up

- Two-channel disconnection of the output stage
- Less external circuitry
- Shorter response times in the event of an error
- Faster restart, intermediate circuit remains charged

#### Interpolating multi-axis movement

- With a suitable controller, the CMMS-AS can perform path movements with interpolation via CANopen. The controller specifies setpoint position values in a fixed

time pattern to this end. In between, the servo positioning controller independently interpolates the data values between two data points.

### Travel program

- Linking of any number of position sets into a travel program
- Further switching conditions for the travel program possible via digital inputs, for example  
MC – motion complete  
I/O – digital inputs

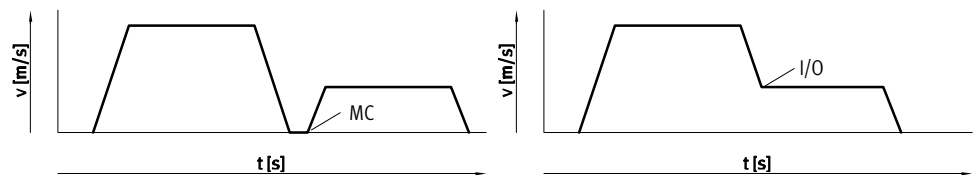

### Library for EPLAN



EPLAN macros for fast and reliable planning of electrical projects in combination with motor controllers,

motors and cables. This enables a high level of planning reliability, standardisation of documentation,

no need to create symbols, graphics and master data.

-  - Type discontinued  
Available up until 2016

## Motor controllers CMMS-AS, for servo motors

Key features

**FESTO**

### FCT software – Festo Configuration Tool

Software platform for electric drives from Festo

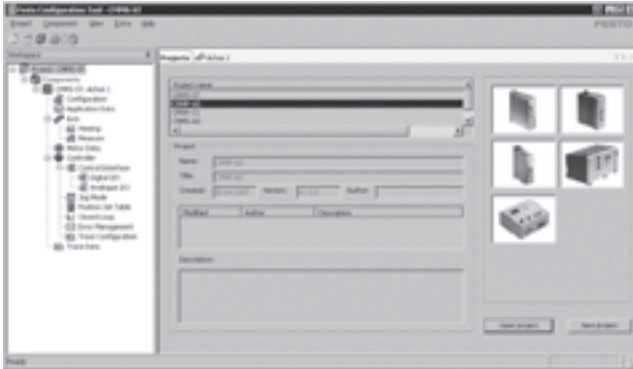

- All drives in a system can be managed and archived in a common project
- Project and data management for all supported device types
- Simple to use thanks to graphically-supported parameter entry
- Universal mode of operation for all drives
- Working offline at your desk or online at the machine

### FHPP – Festo Handling and Positioning Profile

Optimised data profile

Festo has developed an optimised data profile, the “Festo Handling and Positioning Profile (FHPP)”, that is tailored to handling and positioning applications.

The FHPP data profile permits the actuation of Festo motor controllers, using a fieldbus interface, via standardised control and status bytes.

The following are defined, among others:

- Operating modes
- I/O data structure
- Parameter objects
- Sequence control

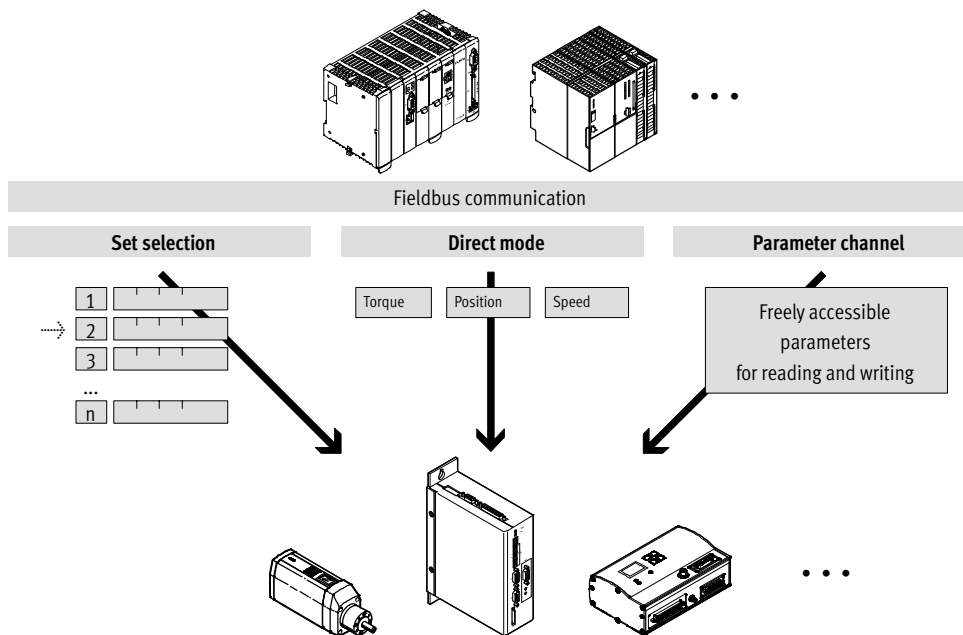

- 1 - Type discontinued  
Available up until 2016

FESTO

## Motor controllers CMMS-AS, for servo motors

Type codes

		CMMS	AS	C4	3A	G2
<b>Type</b>						
CMMS	Motor controller, standard					
<b>Motor technology</b>						
AS	AC synchronous					
<b>Nominal current</b>						
C4	4 A					
<b>Input voltage</b>						
3A	230 V AC					
<b>Generation</b>						
G2	Next generation					

- 1 - Type discontinued  
Available up until 2016

## Motor controllers CMMS-AS, for servo motors

Technical data

FESTO

Fieldbus interfaces

CANopen

PROFIBUS DP

DeviceNet



General technical data		
Type of mounting		Screwed to a mounting plate
Display		7-segment display
Parameterisation interface		RS232 (9,600 ... 115,000 bits/s)
Encoder interface input		Setpoint position value as encoder signal EnDat V2.1 serial / V2.2
Encoder interface output		Actual value feedback via encoder signals in speed control mode Setpoint specification for downstream slave drive Resolution 4,096 ppr
Braking resistor, integrated	[Ω]	230
Pulse power of braking resistor	[kVA]	0.7
Braking resistor, external	[Ω]	≥ 100
Impedance of setpoint input	[kΩ]	20
Number of analogue outputs		1
Operating range of analogue outputs	[V]	0 ... 10
Resolution of analogue outputs	[Bit]	8
Characteristics of analogue outputs		Short circuit-proof
Number of analogue inputs		1
Operating range of analogue inputs	[V]	±10
Characteristics of analogue inputs		Differential inputs Configurable for speed Configurable for torque
Mains filter		Integrated
Max. length of motor cable	[m]	15 (without external mains filter)
Product weight	[g]	1,400

Technical data – Fieldbus interface				
Interfaces	I/O	CANopen	Profibus DP	DeviceNet
Number of digital logic outputs		5		
Characteristics of digital logic outputs		Freely configurable in some cases		
Number of digital logic inputs		14		
Operating range of logic inputs	[V]	12 ... 30		
Characteristics of logic inputs		Freely configurable		
Process coupling		For 63 position sets	For 63 position sets	
Communication profile		–	DS301, FHPP	DP-V0 / FHPP
		–	DS301, DSP402	–
Max. fieldbus transmission rate	[Mbit/s]	–	1	12
Interface	Integrated	■	■	–
	Optional	–	–	■
			→ 11	→ 11

## Motor controllers CMMS-AS, for servo motors

Technical data

Function blocks for PLC programming				
Programming software	Controller manufacturer	Interfaces		
		CANopen	Profibus DP	DeviceNet
CoDeSys	Festo			
	Beckhoff	■	■	■
	Other manufacturers			
RSLogix5000	Rockwell Automation	-	-	■
Step 7	Siemens	-	■	-

Electrical data		
Output connection data		
Output voltage range	[V AC]	0 V up to input voltage
Nominal output current	[A]	4
Peak current	[A]	10
Max. peak current duration	[s]	2
Max. intermediate circuit voltage	[V DC]	320
Output frequency	[Hz]	0 ... 1,000
Load supply		
Nominal voltage phases		1
Input voltage range	[V AC]	95 ... 255
Max. nominal input current	[A]	4
Rated output	[VA]	600
Peak output	[VA]	1,200
Mains frequency	[Hz]	50 ... 60
Logic supply		
Nominal voltage	[V DC]	24 ±20%
Nominal current	[A]	0.35
Max. current (incl. holding brake)	[A]	1.7
Max. current of digital logic outputs	[mA]	100

Safety characteristics	
Safety function to EN 61800-5-2	Safe torque off (STO)
Performance Level (PL) to EN ISO 13849-1	Category 3, Performance Level d
Safety integrity level (SIL) to EN 61800-5-2, EN 62061, EN 61508	SIL 2
MTTFd	STO/2521 years
PFH	$4.53 \times 10^{-8}$
Approval	BIA
Certificate issuing authority	BG MFS 09030
CE marking (see declaration of conformity)	To EU Low Voltage Directive
	To EU EMC Directive <sup>1)</sup>
	To EC Machinery Directive
Vibration resistance	To EN 61800-5-1

1) For information about the applicability of the component see the manufacturer's EC declaration of conformity at: [www.festo.com/sp](http://www.festo.com/sp) → User documentation.  
If the component is subject to restrictions on usage in residential, office or commercial environments or small businesses, further measures to reduce the emitted interference may be necessary.

- 1 - Type discontinued  
Available up until 2016

## Motor controllers CMMS-AS, for servo motors

FESTO

Technical data

Operating and environmental conditions	
Digital logic outputs	Not galvanically isolated
Logic inputs	Galvanically connected to logic potential
Degree of protection	IP20
Protective function	I <sup>2</sup> t monitoring
	Intermediate circuit over/undervoltage
	Output stage short circuit
	Standstill monitoring
	Temperature monitoring
Ambient temperature [°C]	0 ... +50
Note on ambient temperature	4% reduction per °C above 40 °C
Storage temperature [°C]	-25 ... +70
Relative air humidity [%]	0 ... 90 (non-condensing)
CE marking (see declaration of conformity)	To EU Low Voltage Directive
	To EU EMC Directive <sup>1)</sup>
	To EU Machinery Directive
Approval	c UL - Recognised (OL)
	UL listed (OL)
	C-Tick
Note on materials	RoHS-compliant

- 1) For information about the applicability of the component see the manufacturer's EC declaration of conformity at: [www.festo.com/sp](http://www.festo.com/sp) → User documentation.  
If the component is subject to restrictions on usage in residential, office or commercial environments or small businesses, further measures to reduce the emitted interference may be necessary.



## Motor controllers CMMS-AS, for servo motors

Technical data

### View of motor controller

From the front

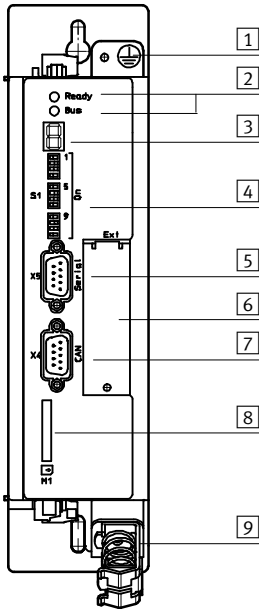

- 1 Earthing
- 2 Ready/bus LED
- 3 Status display
- 4 Fieldbus settings and boot loader
- 5 Interface: RS232/RS485
- 6 Technology module (optional)
- 7 Interface: CAN bus
- 8 SD memory card
- 9 Screened connection

From above

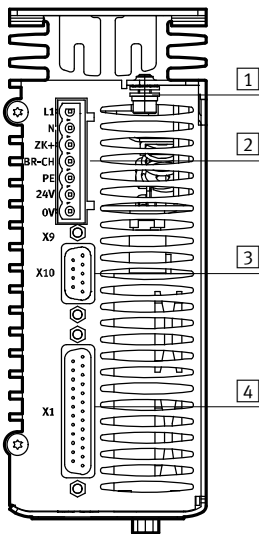

- 1 Earthing screw
- 2 Power supply
- 3 Incremental encoder interface (bidirectional)
- 4 I/O interface

From underneath

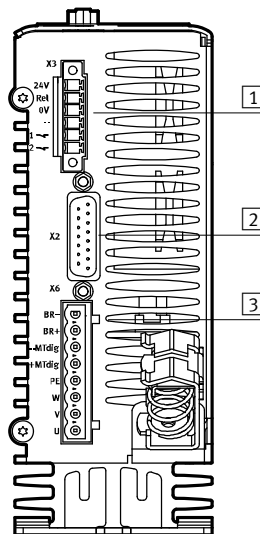

- 1 Safe stop
- 2 Encoder connection
- 3 Motor connection

-  - Type discontinued  
Available up until 2016

## Motor controllers CMMS-AS, for servo motors

Technical data

FESTO

### Installation clearance for motor controller

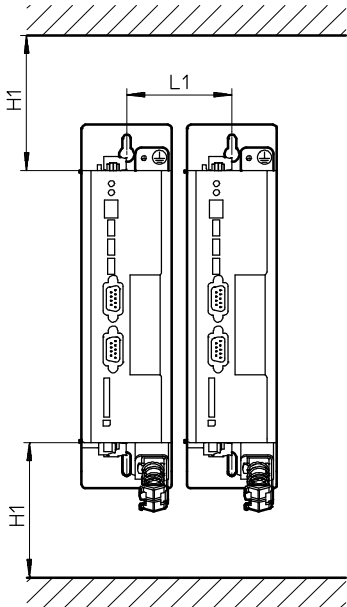

H1	L1
100	70

### Dimensions

Download CAD data → [www.festo.com](http://www.festo.com)

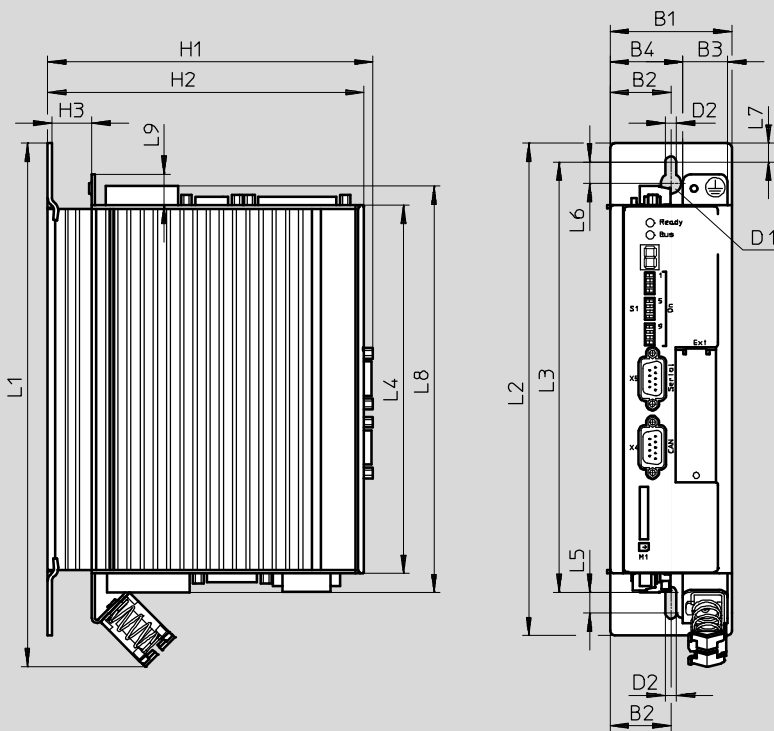

Type	B1	B2	B3	B4	D1	D2	H1	H2	H3
CMMS-AS	60	30	22	35.8	10	5.5	160	155.5	19.7

Type	L1	L2	L3	L4	L5	L6	L7	L8	L9
CMMS-AS	257.6	242.1	211.9	181	10	10.5	9.25	200	15.3

- 2 - Type discontinued  
Available up until 2016

FESTO

## Motor controllers CMMS-AS, for servo motors

Technical data and accessories

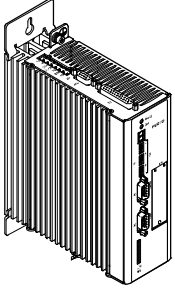
Ordering data			
	Brief description	Part No.	Type
	The plug assortment NEKM (→ 13) and the operator package (→ 13) are included in the scope of delivery.	572986	CMMS-AS-C4-3A-G2

### Accessories

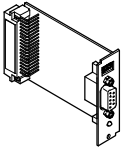
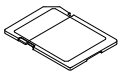
Ordering data – Plug-in cards			
	Brief description	Part No.	Type
	Interface, for Profibus interface	547450	CAMC-PB
	Interface, for DeviceNet interface	547451	CAMC-DN
	Memory card, for data backup and firmware downloads	1436343	CAMC-M-S-F10-V1

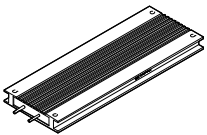
Ordering data – Braking resistances				
	Resistance value [Ω]	Nominal power [W]	Part No.	Type
	100	500	1336615	CACR-LE2-100-W500



 Type discontinued  
Available up until 2016

## Motor controllers CMMS-AS, for servo motors

Accessories

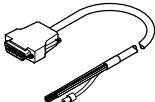
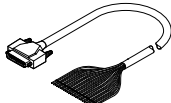
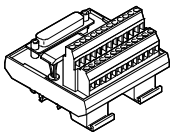
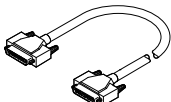
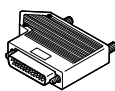
FESTO

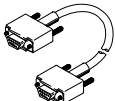
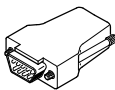
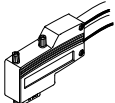
Ordering data – Connection options from I/O interface to controller				
	Description	Cable length [m]	Part No.	Type
<b>Control cable</b>				
	<ul style="list-style-type: none"> <li>For I/O interface to any controller</li> <li>Recommended for analogue signals since the cable is shielded</li> </ul>	2.5	<b>552254</b>	<b>NEBC-S1G25-K-2.5-N-LE26</b>
	<ul style="list-style-type: none"> <li>For I/O interface to any controller</li> <li>Cannot be used if the incremental encoder interface (input) is in use</li> </ul>	3.2	<b>8001373</b>	<b>NEBC-S1G25-K-3.2-N-LE25</b>
<b>Connection block</b>				
	Ensures simple and clear wiring. The connection to the motor controller is established via the connecting cable NEBC-S1G25-K-...	–	<b>8001371</b>	<b>NEFC-S1G25-C2W25-S7</b>
<b>Connecting cable</b>				
	Connects the motor controller to the connection block	1.0	<b>8001374</b>	<b>NEBC-S1G25-K-1.0-N-S1G25</b>
		2.0	<b>8001375</b>	<b>NEBC-S1G25-K-2.0-N-S1G25</b>
		5.0	<b>8001376</b>	<b>NEBC-S1G25-K-5.0-N-S1G25</b>
<b>Plug connector</b>				
	25-pin Sub-D plug. Each wire can be individually assembled using screw terminals	–	<b>8001372</b>	<b>NEFC-S1G25-C2W25-S6</b>

Ordering data – Cables and plugs				
	Description	Cable length [m]	Part No.	Type
<b>Programming cable</b>				
	–	1.5	<b>160786</b>	<b>PS1-ZK11-NULLMODEM-1,5M</b>
<b>Encoder plug</b>				
	For incremental encoder interface	–	<b>564264</b>	<b>NECC-A-S-S1G9-C2M</b>
<b>Plug connector</b>				
	For PROFIBUS interface	–	<b>533780</b>	<b>FBS-SUB-9-WS-PB-K</b>
	For CANopen interface	–	<b>533783</b>	<b>FBS-SUB-9-WS-CO-K</b>
	For DeviceNet interface	–	<b>525635</b>	<b>FBSD-KL-2X5POL</b>

## Motor controllers CMMS-AS, for servo motors

Accessories

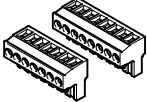
Ordering data – Plug assortment			
	Description	Part No.	Type
	<ul style="list-style-type: none"> <li>Comprising plug for power supply and motor connection</li> <li>The plug assortment is included in the scope of delivery of the motor controller</li> </ul>	560504	NEKM-C-4

Ordering data – Software and documentation			
	Description	Part No.	Type
	<p>Operator package contains:</p> <ul style="list-style-type: none"> <li>– CD-ROM <ul style="list-style-type: none"> <li>– With user documentation for the CMMS-AS, in de, en, es, fr, it</li> <li>– With FCT (Festo Configuration Tool) configuration software, in de, en</li> <li>– Brief description</li> </ul> </li> </ul> <p>The package is included in the scope of delivery</p>	573740	GSIB-CMMS-AS-G2-ML

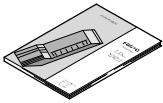
Ordering data – Documentation <sup>1)</sup>						
	Language	Part No. Type		Part No. Type		
		For motor controller		Festo Handling and Positioning Profile (FHPP) for the motor controller range CMM...		
	DE	564227	P.BE-CMMS-AS-3A-HW-DE	555695	P.BE-CMM-FHPP-SW-DE	
	EN	564228	P.BE-CMMS-AS-3A-HW-EN	555696	P.BE-CMM-FHPP-SW-EN	
	ES	564229	P.BE-CMMS-AS-3A-HW-ES	555697	P.BE-CMM-FHPP-SW-ES	
	FR	564230	P.BE-CMMS-AS-3A-HW-FR	555698	P.BE-CMM-FHPP-SW-FR	
	IT	564231	P.BE-CMMS-AS-3A-HW-IT	555699	P.BE-CMM-FHPP-SW-IT	
			For CANopen interface		For PROFIBUS interface	
	DE	554351	P.BE-CMMS-FHPP-CO-SW-DE	554345	P.BE-CMMS-FHPP-PB-SW-DE	
	EN	554352	P.BE-CMMS-FHPP-CO-SW-EN	554346	P.BE-CMMS-FHPP-PB-SW-EN	
	ES	554353	P.BE-CMMS-FHPP-CO-SW-ES	554347	P.BE-CMMS-FHPP-PB-SW-ES	
	FR	554354	P.BE-CMMS-FHPP-CO-SW-FR	554348	P.BE-CMMS-FHPP-PB-SW-FR	
	IT	554355	P.BE-CMMS-FHPP-CO-SW-IT	554349	P.BE-CMMS-FHPP-PB-SW-IT	
			For DeviceNet interface			
	DE	554357	P.BE-CMMS-FHPP-DN-SW-DE			
	EN	554358	P.BE-CMMS-FHPP-DN-SW-EN			
	ES	554359	P.BE-CMMS-FHPP-DN-SW-ES			
FR	554360	P.BE-CMMS-FHPP-DN-SW-FR				
IT	554361	P.BE-CMMS-FHPP-DN-SW-IT				

1) User documentation in paper form is not included in the scope of delivery

## Product Range and Company Overview

### A Complete Suite and Company Overview

Our experienced engineers provide complete support at every stage of your development process, including: conceptualization, analysis, engineering, design, assembly, documentation, validation, and production.



**Custom Automation Components**  
Complete custom engineered solutions



**Custom Control Cabinets**  
Comprehensive engineering support and on-site services



**Complete Systems**  
Shipment, stocking and storage services

### The Broadest Range of Automation Components

With a comprehensive line of more than 30,000 automation components, Festo is capable of solving the most complex automation requirements.



**Electromechanical**  
Electromechanical actuators, motors, controllers & drivers



**Pneumatics**  
Pneumatic linear and rotary actuators, valves, and air supply



**PLCs and I/O Devices**  
PLC's, operator interfaces, sensors and I/O devices

### Supporting Advanced Automation... As No One Else Can!

Festo is a leading global manufacturer of pneumatic and electromechanical systems, components and controls for industrial automation, with more than 16,000 employees in 60 national headquarters serving more than 180 countries. For more than 80 years, Festo has continuously elevated the state of manufacturing with innovations and optimized motion control solutions that deliver higher performing, more profitable automated manufacturing and processing equipment. Our dedication to the advancement of automation extends beyond technology to the education and development of current and future automation and robotics designers with simulation tools, teaching programs, and on-site services.

### Quality Assurance, ISO 9001 and ISO 14001 Certifications

Festo Corporation is committed to supply all Festo products and services that will meet or exceed our customers' requirements in product quality, delivery, customer service and satisfaction.

To meet this commitment, we strive to ensure a consistent, integrated, and systematic approach to management that will meet or exceed the requirements of the ISO 9001 standard for Quality Management and the ISO 14001 standard for Environmental Management.



© Copyright 2013, Festo Corporation. While every effort is made to ensure that all dimensions and specifications are correct, Festo cannot guarantee that publications are completely free of any error, in particular typing or printing errors. Accordingly, Festo cannot be held responsible for the same. For Liability and Warranty conditions, refer to our "Terms and Conditions of Sale", available from your local Festo office. All rights reserved. No part of this publication may be reproduced, distributed, or transmitted in any form or by any means, electronic, mechanical, photocopying or otherwise, without the prior written permission of Festo. All technical data subject to change according to technical update.



Printed on recycled paper at New Horizon Graphic, Inc., FSC certified as an environmental friendly printing plant.

# Festo North America

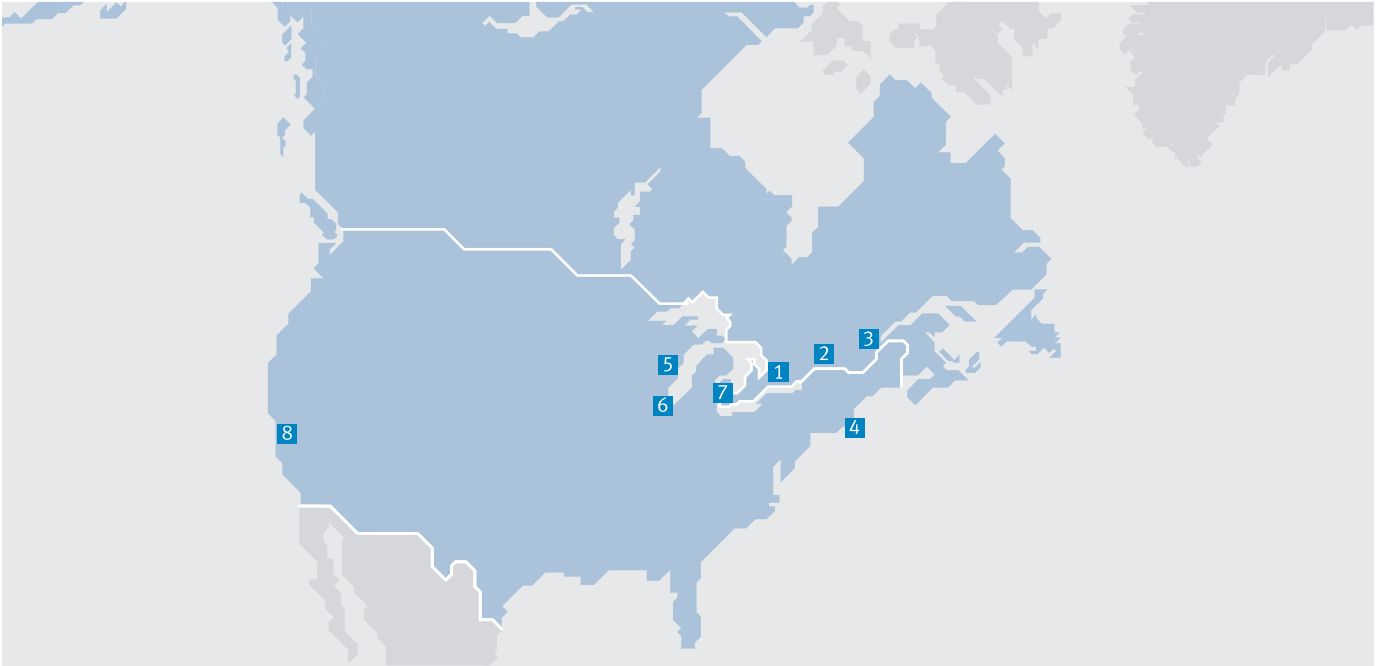

**1 Festo Canada  
Headquarters  
Festo Inc.**  
5300 Explorer Drive  
Mississauga, ON  
L4W 5G4

**2 Montréal**  
5600, Trans-Canada  
Pointe-Claire, QC  
H9R 1B6

**3 Québec City**  
2930, rue Watt#117  
Québec, QC  
G1X 4G3



**4 Festo United States  
Headquarters  
Festo Corporation**  
395 Moreland Road  
Hauppauge, NY  
11788

**5 Appleton**  
North 922 Tower View Drive, Suite N  
Greenville, WI  
54942

**7 Detroit**  
1441 West Long Lake Road  
Troy, MI  
48098

**6 Chicago**  
85 W Algonquin - Suite 340  
Arlington Heights, IL  
60005

**8 Silicon Valley**  
4935 Southfront Road, Suite F  
Livermore, CA  
94550

## Festo Regional Contact Center

### Canadian Customers

Commercial Support:  
Tel: 1 877 GO FESTO (1 877 463 3786)  
Fax: 1 877 FX FESTO (1 877 393 3786)  
Email: festo.canada@ca.festo.com

Technical Support:  
Tel: 1 866 GO FESTO (1 866 463 3786)  
Fax: 1 877 FX FESTO (1 877 393 3786)  
Email: technical.support@ca.festo.com

### USA Customers

Commercial Support:  
Tel: 1 800 99 FESTO (1 800 993 3786)  
Fax: 1 800 96 FESTO (1 800 963 3786)  
Email: customer.service@us.festo.com

Technical Support:  
Tel: 1 866 GO FESTO (1 866 463 3786)  
Fax: 1 800 96 FESTO (1 800 963 3786)  
Email: product.support@us.festo.com