

Motor controllers CMMD-AS, for servo motors



Motor controllers CMMD-AS, for servo motors

Key features

Comparison of motor controllers		
Motor controller for motor type	CMMP-AS Servo motor	CMMS-ST Stepper motor
Positioning records	255	63
Measuring system	Analogue/incremental/absolute	Incremental
Extended I/O interface	Flexibly configurable	4 working modes
Notification of remaining distance	Separately for all positions	1 for n
Torque reduction	Separately for all positions	No
Set linking	With branching	Linear
Safety functions to EN 61800-5-2	STO, SS1, SBC, SOS, SS2, SLS, SSR, SSM	STO, SS1 (with external safety switching device)

Performance characteristics

Compactness

- The double motor controller CMMD-AS consists of two identical motor controllers CMMS-AS in one housing
- Intermediate circuits are connected internally
- Braking resistors are connected in parallel internally so that twice the continuous braking performance is available
- Total nominal current is 8 A. The nominal current can be flexibly distributed between the axes

- Small dimensions
- Full integration of all components for controller and power section, including RS232 and CANopen interface
- Integrated brake chopper
- Integrated EMC filters
- Automatic actuation for a holding brake
- Complies with the current CE and EN standards without additional external measures (motor cable length of up to 15 m)

Motion control

- Digital absolute angle encoder in single-turn and multi-turn versions
- Can be operated as a torque, speed or position controller
- Integrated position controller
- Time-optimised (trapezoidal) or jerk-free (S-shaped) positioning
- Absolute and relative movements
- Point-to-point positioning with and without motion path smoothing
- Position synchronisation
- Electronic gear unit
- 2x 63 positioning records
- 2x 8 positioning profiles
- Wide range of homing methods

Fieldbus interfaces

Integrated:



Optional:



Input/output

- Freely programmable I/Os
- High-resolution 12-bit analogue input
- Jog/teach-in mode
- Easy linking to a higher-level controller via I/O or fieldbus
- Synchronous operation
- Master/slave mode
- Additional I/Os with the plug-in card CAMC-D-8E8A → 11

Integrated sequence control

- Automatic sequence of positioning records without a higher-level controller
- Linear and cyclical position sequences
- Adjustable delay times

Motor controllers CMMD-AS, for servo motors

Key features

Performance characteristics

Integrated safety functions

- The motor controller CMMD-AS support the "Safe Torque Off (STO)" and, by providing a reliable time delay, also supports "Safe Stop 1 (SS1)" safety functions with protection against unexpected start-up in accordance with EN 61800-5-2
- Protection against unexpected start-up

- Two-channel disconnection of the output stage
- Reduced external circuitry
- Shorter response times in the event of an error
- Faster restart, intermediate circuit remains charged

Interpolating multi-axis movement

- With a suitable controller, the CMMD-AS can perform path movements with interpolation via CAN-open. The controller specifies setpoint position values in a fixed

time pattern to this end. In between, the servo position controller independently interpolates the data values between two data points.

Travel program

- Linking of any number of positioning records into a travel program
- Step criteria for the travel program possible via digital inputs, for example
MC – motion complete
I/O – digital inputs

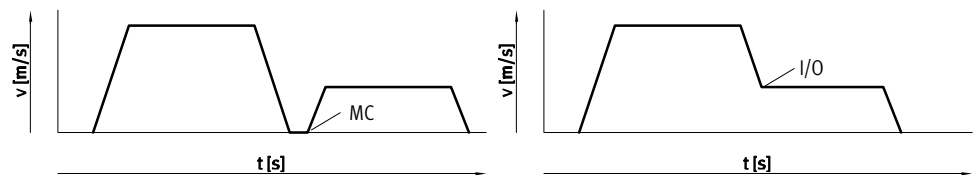

Library for EPLAN



EPLAN macros for fast and reliable planning of electrical projects in combination with motor controllers,

motors and cables. This enables a high level of planning reliability, standardisation of

documentation, no need to create symbols, graphics and master data.

-  - Type discontinued
Available up until 2016

Motor controllers CMMD-AS, for servo motors

Key features

FESTO

FCT software – Festo Configuration Tool

Software platform for electric drives from Festo

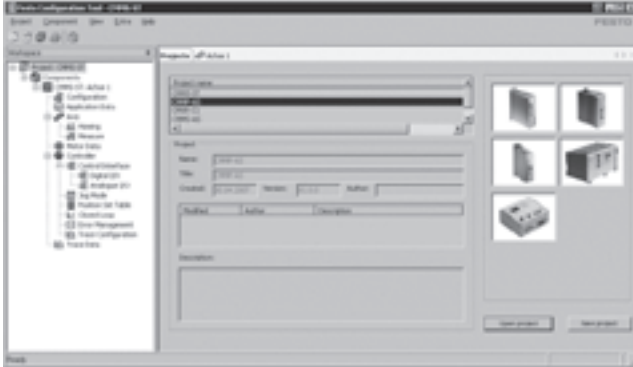

- All drives in a system can be managed and saved in a common project
- Project and data management for all supported device types
- Easy to use thanks to graphically supported parameter entry
- Universal mode of operation for all drives
- Working offline at your desk or online at the machine

FHPP – Festo Handling and Positioning Profile

Optimised data profile

Festo has developed an optimised data profile especially tailored to the target applications for handling and positioning tasks, the "Festo Handling and Positioning Profile (FHPP)".

The FHPP data profile permits the actuation of Festo motor controllers, using a fieldbus interface, via standardised control and status bytes.

The following are defined, among others:

- Operating modes
- I/O data structure
- Parameter objects
- Sequence control

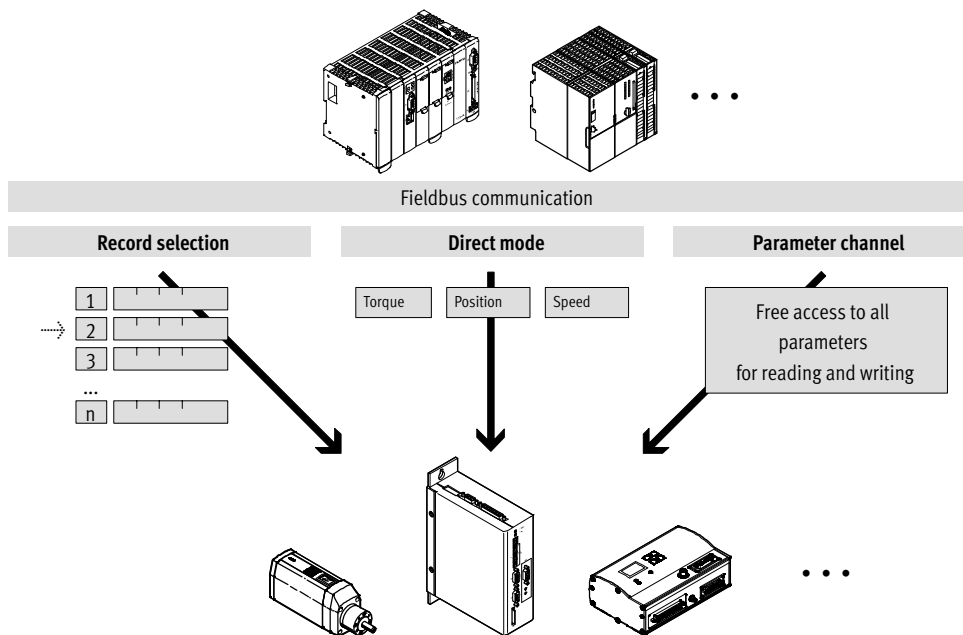

- 1 - Type discontinued
Available up until 2016

FESTO

Motor controllers CMMD-AS, for servo motors

Type codes

Type	
CMMD	Double motor controller

Motor technology	
AS	AC synchronous

Nominal current	
C8	8 A

Input voltage	
3A	230 V AC

CMMD - AS - C8 - 3A

- 1 - Type discontinued
Available up until 2016

Motor controllers CMMD-AS, for servo motors

Technical data

FESTO

Fieldbus interfaces

CANopen



DeviceNet



General technical data	
Type of mounting	Screwed to a mounting plate
Display	7-segment display
Parameterisation interface	RS232 (9600 ... 115000 bits/s)
Encoder interface input	Setpoint position value as encoder signal EnDat V2.1 serial / V2.2
Encoder interface output	Actual value feedback via encoder signals in speed control mode Setpoint specification for downstream slave drive Resolution 4096 ppr
Braking resistor, integrated	[Ω] 115
Pulse power of braking resistor	[kVA] 1.4
Braking resistor, external	[Ω] 50
Impedance of setpoint input	[kΩ] 20
Number of analogue outputs	2
Operating range of analogue outputs	[V] 0 ... 10
Resolution of analogue outputs	[bit] 8
Characteristics of analogue outputs	Short circuit proof
Number of analogue inputs	2
Operating range of analogue inputs	[V] ±10
Characteristics of analogue inputs	Differential inputs Configurable for speed Configurable for current
Mains filter	Integrated
Max. length of motor cable	[m] 15 (without external mains filter)
Product weight	[g] 2400

Technical data – Fieldbus interface				
Interfaces	I/O	CANopen	Profibus DP	DeviceNet
Number of digital logic outputs	10			
Characteristics of digital logic outputs	Freely configurable in some cases			
Number of digital logic inputs	28			
Operating range of logic inputs	[V] 12 ... 30			
Characteristics of logic inputs	Freely configurable			
Process coupling	For 2x 63 positioning records	For 2x 63 positioning records		
Communication profile	–	DS301, FHPP	DP-V0/FHPP	FHPP
	–	DS301, DSP402	–	–
Max. fieldbus transmission rate	[Mbps] –	1	12	0.5
Interface	Integrated	■	■	–
	Optional	–	–	■
			→ 12	→ 12

Motor controllers CMMD-AS, for servo motors

Technical data

Function blocks for PLC programming				
Programming software	Controller manufacturer	Interfaces		
		CANopen	Profibus DP	DeviceNet
CoDeSys	Festo			
	Beckhoff	■	■	■
	Other manufacturers			
RSLogix5000	Rockwell Automation	-	-	■
Step 7	Siemens	-	■	-

Electrical data		
Output port data		
Output voltage range	[V AC]	0 V to the input voltage
Nominal output current	[A]	8
Peak current	[A]	20
Max. peak current duration	[s]	2
Max. intermediate circuit voltage	[V DC]	380
Output frequency	[Hz]	0 1,000
Load supply		
Nominal voltage phases		1
Input voltage range	[V AC]	95 ... 255
Max. nominal input current	[A]	10
Rated output	[VA]	1200
Peak output	[VA]	2400
Mains frequency	[Hz]	50 ... 60
Logic supply		
Nominal voltage	[V DC]	24 ±20%
Nominal current	[A]	0.7
Peak current (incl. holding brake)	[A]	3.6
Max. current of digital logic outputs	[mA]	100

Safety characteristics	
Safety function to EN 61800-5-2	Safe torque off (STO)
Performance Level (PL) to EN ISO 13849-1	Category 3, Performance Level d
Safety integrity level (SIL) to EN 61800-5-2, EN 62061, EN 61508	SIL 2
MTTFd	STO/2521 years
PFH	4.53×10^{-8}
Approval	BIA
Certificate issuing authority	BG MFS 10009
CE marking (see declaration of conformity)	To EU Low Voltage Directive
	To EU EMC Directive ¹⁾
	To EC Machinery Directive
Vibration resistance	To EN 61800-5-1

1) For information about the applicability of the component see the manufacturer's EC declaration of conformity at: www.festo.com/sp → User documentation.
If the component is subject to restrictions on usage in residential, office or commercial environments or small businesses, further measures to reduce the emitted interference may be necessary.

- 1 - Type discontinued
Available up until 2016

FESTO

Motor controllers CMMD-AS, for servo motors

Technical data

Operating and environmental conditions	
Digital logic outputs	Not galvanically isolated
Logic inputs	Galvanically connected to logic potential
Degree of protection	IP20
Protective function	I ² t monitoring
	Intermediate circuit over/undervoltage
	Output stage short circuit
	Standstill monitoring
	Temperature monitoring
Surge resistance [kV]	4
Ambient temperature [°C]	0 ... +50
Note on ambient temperature	4% reduction per °C above 40 °C
Storage temperature [°C]	-25 ... +70
Relative air humidity [%]	0 ... 90 (non-condensing)
CE marking (see declaration of conformity)	To EU Low Voltage Directive
	To EU EMC Directive ¹⁾
	To EU Machinery Directive
Approval	c UL - Recognised (OL)
	UL listed (OL)
	C-Tick
Note on materials	RoHS-compliant

1) For information about the applicability of the component see the manufacturer's EC declaration of conformity at: www.festo.com/sp → User documentation.
If the component is subject to restrictions on usage in residential, office or commercial environments or small businesses, further measures to reduce the emitted interference may be necessary.

Motor controllers CMMD-AS, for servo motors

Technical data

View of motor controller

From the front

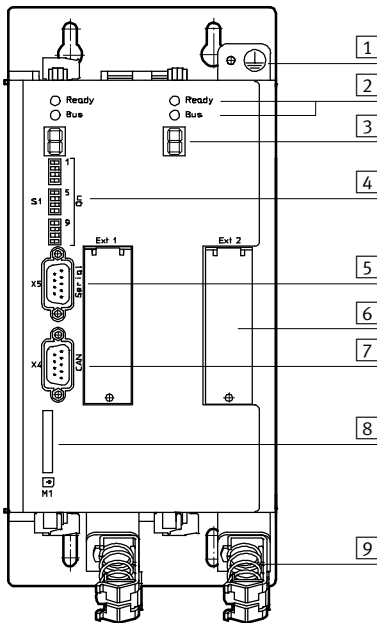

- 1 Earthing
- 2 Ready/bus LED
- 3 Status displays
- 4 Fieldbus settings and boot loader
- 5 Interface: RS232/RS485
- 6 Technology modules (optional)
- 7 Interface: CAN bus
- 8 SD memory card
- 9 Screened connections

From above

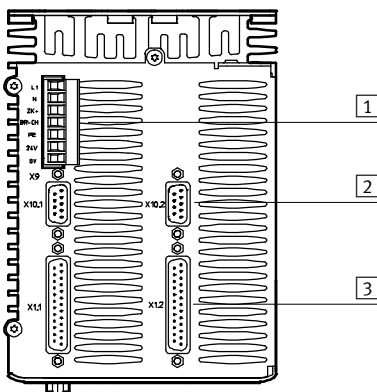

- 1 Power supply
- 2 Incremental encoder interface (bidirectional)
- 3 I/O interface

From underneath

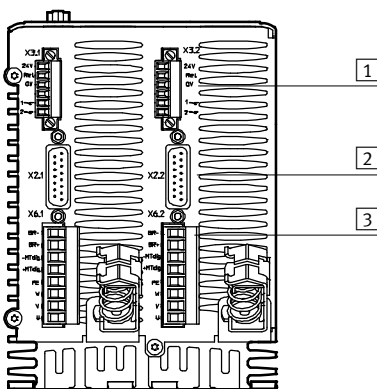

- 1 Safe stop
- 2 Encoder connection
- 3 Motor connection

-  - Type discontinued
Available up until 2016

Motor controllers CMMD-AS, for servo motors

Technical data

FESTO

Installation clearance for motor controller

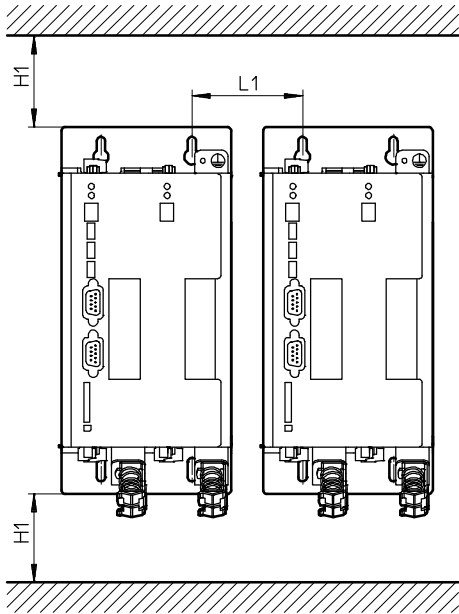

H1	L1
100	73

Dimensions

Download CAD data → www.festo.com

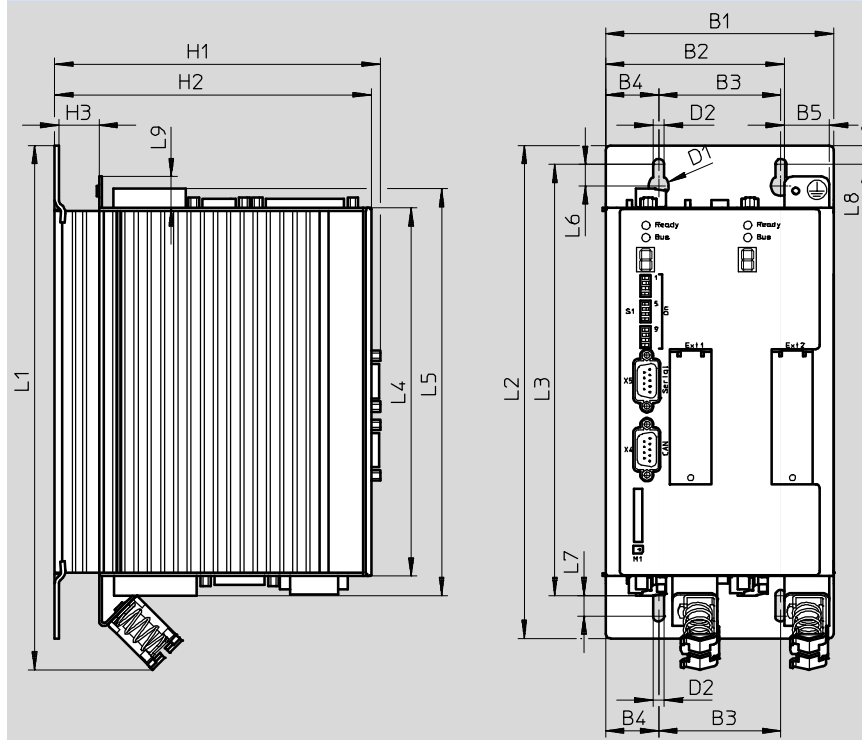

Type	B1	B2	B3	B4	B5	D1	D2	H1	H2	H3
CMMD-AS	112	87.8	60	26	22	10	5.5	160	155.5	19.7

Type	L1	L2	L3	L4	L5	L6	L7	L8	L9
CMMD-AS	257.6	242.1	211.85	181	200	10.5	10	9.25	15.3

Motor controllers CMMD-AS, for servo motors

Technical data and accessories

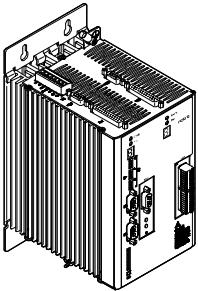
Ordering data			
	Description	Part No.	Type
	The plug assortment NEKM (→ 12) and the operator package (→ 13) are included in the scope of delivery.	561406	CMMD-AS-C8-3A

Accessories

Interface CAMC-D-8E8A

The interface is used to extend the digital I/Os.

Up to two interfaces are supported simultaneously.



Technical data		
General information		
Max. cable cross section	[mm ²]	0.5
Digital inputs		
Number		8
Nominal voltage	[V DC]	24
Voltage range	[V]	-30 ... +30 (protected against reverse polarity and short circuit proof)
Nominal value for True	[V]	8
Nominal value for False	[V]	2
Input impedance	[kΩ]	4.7
Digital outputs		
Number		8
Nominal voltage	[V DC]	24
Voltage range	[V]	+18 ... +30 (protected against reverse polarity and short circuit proof, protection in the event of thermal overload)
Output current	[mA]	100
Short circuit, overcurrent protection	[mA]	500

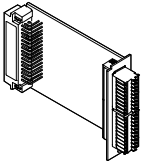

Ordering data – Plug-in card			
	Description	Part No.	Type
	For additional I/Os (The plugs are included in the scope of delivery. Plug NEKM for reorder → 12)	567855	CAMC-D-8E8A

 **Type discontinued**
Available up until 2016

Motor controllers CMMD-AS, for servo motors

Accessories

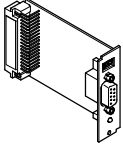
FESTO

Ordering data – Plug-in cards				
	Brief description	Part No.	Type	
	Interface module, for Profibus interface	547450	CAMC-PB	
	Interface module, for DeviceNet interface	547451	CAMC-DN	
	Memory card, for data backup and firmware downloads	1436343	CAMC-M-S-F10-V1	

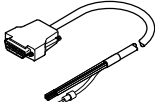
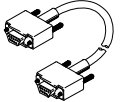
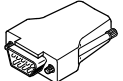
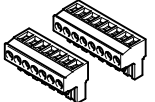
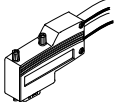
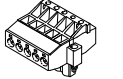
Ordering data – Cables and plugs				
	Brief description	Cable length [m]	Part No.	Type
	Control cable, for I/O interface to any controller	2.5	552254	NEBC-S1G25-K-2.5-N-LE26
	Programming cable	1.5	160786	PS1-ZK11-NULLMODEM-1,5M
	Encoder plug, for incremental encoder interface	–	564264	NECC-A-S-S1G9-C2M
	Plug assortment for CMMD	–	560504	NEKM-C-4 ¹⁾
	Plug assortment for interface CAMC-D-8E8A	–	569959	NEKM-C-5 ²⁾
	Plug for Profibus interface	–	533780	FBS-SUB-9-WS-PB-K
	Plug for CANopen interface	–	533783	FBS-SUB-9-WS-CO-K
	Plug for DeviceNet interface	–	525635	FBSD-KL-2X5POL

- 1) Comprising plug for power supply and plug for motor connection. The plug assortment is included in the scope of delivery of the motor controller.
2) Plugs are included in the scope of delivery of the interface card CAMC-D-8E8A.

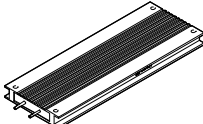
Ordering data – Braking resistances				
	Resistance value [Ω]	Nominal power [W]	Part No.	Type
	50	500	2882342	CACR-LE2-50-W500 ¹⁾
	72	500	1336611	CACR-LE2-72-W500

- 1) Recommended braking resistor

Motor controllers CMMD-AS, for servo motors

Accessories

Ordering data – Software and documentation			
	Brief description	Part No.	Type
	Operator package contains: – CD-ROM – with manual for CMMD-AS, in de, en, es, fr, it – with FCT (Festo Configuration Tool) configuration software, in de, en – Brief description This package is included in the scope of delivery	570608	GSIB-CMMD-AS-ML

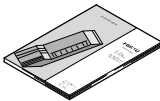
Ordering data – Documentation ¹⁾						
	Language	Part No.		Type		
		For motor controller		Festo Handling and Positioning Profile (FHPP) for the motor controller range CMM...		
	DE	571733	P.BE-CMMD-AS-3A-HW-DE	555695	P.BE-CMM-FHPP-SW-DE	
	EN	571734	P.BE-CMMD-AS-3A-HW-EN	555696	P.BE-CMM-FHPP-SW-EN	
	ES	571735	P.BE-CMMD-AS-3A-HW-ES	555697	P.BE-CMM-FHPP-SW-ES	
	FR	571736	P.BE-CMMD-AS-3A-HW-FR	555698	P.BE-CMM-FHPP-SW-FR	
	IT	571737	P.BE-CMMD-AS-3A-HW-IT	555699	P.BE-CMM-FHPP-SW-IT	
		For CANopen interface			For Profibus interface	
	DE	554351	P.BE-CMMS-FHPP-CO-SW-DE	554345	P.BE-CMMS-FHPP-PB-SW-DE	
	EN	554352	P.BE-CMMS-FHPP-CO-SW-EN	554346	P.BE-CMMS-FHPP-PB-SW-EN	
	ES	554353	P.BE-CMMS-FHPP-CO-SW-ES	554347	P.BE-CMMS-FHPP-PB-SW-ES	
	FR	554354	P.BE-CMMS-FHPP-CO-SW-FR	554348	P.BE-CMMS-FHPP-PB-SW-FR	
	IT	554355	P.BE-CMMS-FHPP-CO-SW-IT	554349	P.BE-CMMS-FHPP-PB-SW-IT	
		For DeviceNet interface				
	DE	554357	P.BE-CMMS-FHPP-DN-SW-DE			
	EN	554358	P.BE-CMMS-FHPP-DN-SW-EN			
	ES	554359	P.BE-CMMS-FHPP-DN-SW-ES			
	FR	554360	P.BE-CMMS-FHPP-DN-SW-FR			
	IT	554361	P.BE-CMMS-FHPP-DN-SW-IT			

1) Manual in paper form is not included in the scope of delivery

Product Range and Company Overview

A Complete Suite and Company Overview

Our experienced engineers provide complete support at every stage of your development process, including: conceptualization, analysis, engineering, design, assembly, documentation, validation, and production.

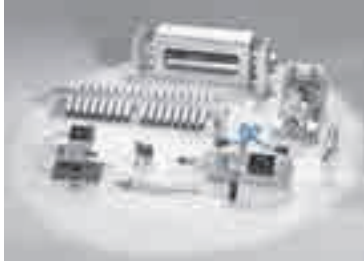

Custom Automation Components
Complete custom engineered solutions



Custom Control Cabinets
Comprehensive engineering support and on-site services



Complete Systems
Shipment, stocking and storage services

The Broadest Range of Automation Components

With a comprehensive line of more than 30,000 automation components, Festo is capable of solving the most complex automation requirements.



Electromechanical
Electromechanical actuators, motors, controllers & drivers



Pneumatics
Pneumatic linear and rotary actuators, valves, and air supply



PLCs and I/O Devices
PLC's, operator interfaces, sensors and I/O devices

Supporting Advanced Automation... As No One Else Can!

Festo is a leading global manufacturer of pneumatic and electromechanical systems, components and controls for industrial automation, with more than 16,000 employees in 60 national headquarters serving more than 180 countries. For more than 80 years, Festo has continuously elevated the state of manufacturing with innovations and optimized motion control solutions that deliver higher performing, more profitable automated manufacturing and processing equipment. Our dedication to the advancement of automation extends beyond technology to the education and development of current and future automation and robotics designers with simulation tools, teaching programs, and on-site services.

Quality Assurance, ISO 9001 and ISO 14001 Certifications

Festo Corporation is committed to supply all Festo products and services that will meet or exceed our customers' requirements in product quality, delivery, customer service and satisfaction.

To meet this commitment, we strive to ensure a consistent, integrated, and systematic approach to management that will meet or exceed the requirements of the ISO 9001 standard for Quality Management and the ISO 14001 standard for Environmental Management.



© Copyright 2013, Festo Corporation. While every effort is made to ensure that all dimensions and specifications are correct, Festo cannot guarantee that publications are completely free of any error, in particular typing or printing errors. Accordingly, Festo cannot be held responsible for the same. For Liability and Warranty conditions, refer to our "Terms and Conditions of Sale", available from your local Festo office. All rights reserved. No part of this publication may be reproduced, distributed, or transmitted in any form or by any means, electronic, mechanical, photocopying or otherwise, without the prior written permission of Festo. All technical data subject to change according to technical update.



Printed on recycled paper at New Horizon Graphic, Inc., FSC certified as an environmental friendly printing plant.

Festo North America

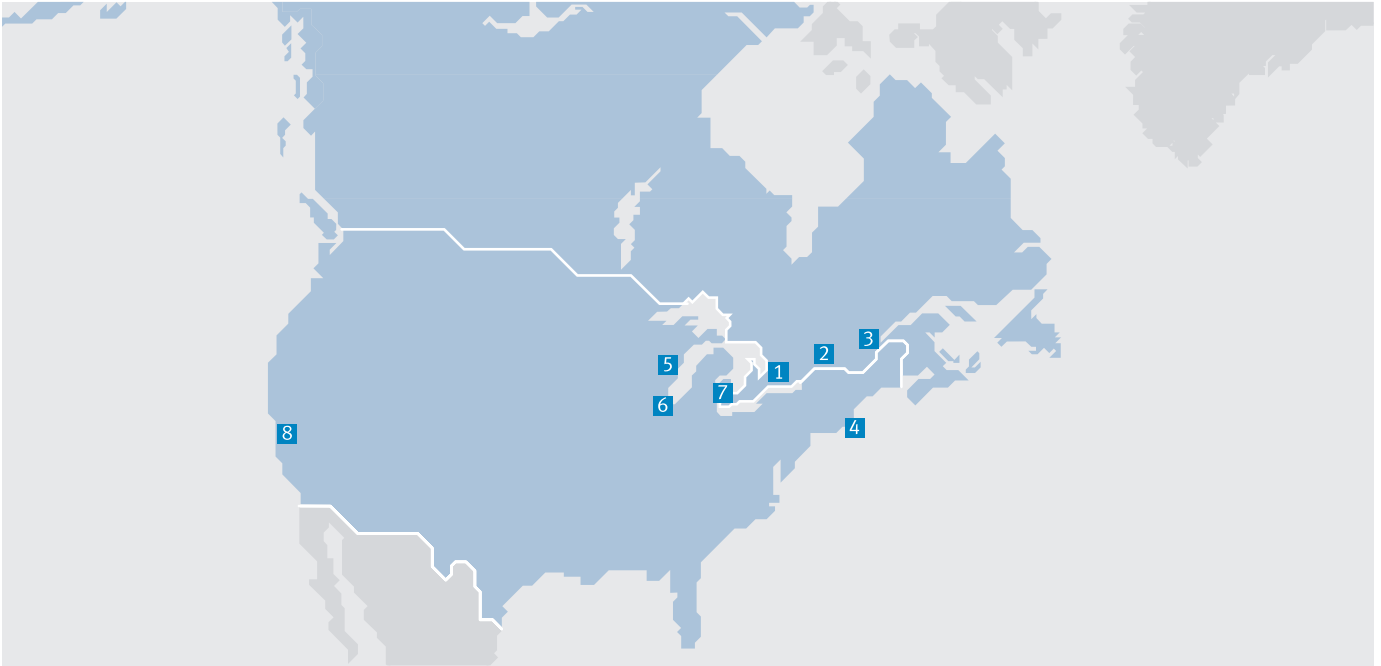

**1 Festo Canada
Headquarters
Festo Inc.**
5300 Explorer Drive
Mississauga, ON
L4W 5G4

2 Montréal
5600, Trans-Canada
Pointe-Claire, QC
H9R 1B6

3 Québec City
2930, rue Watt#117
Québec, QC
G1X 4G3



**4 Festo United States
Headquarters
Festo Corporation**
395 Moreland Road
Hauppauge, NY
11788

5 Appleton
North 922 Tower View Drive, Suite N
Greenville, WI
54942

7 Detroit
1441 West Long Lake Road
Troy, MI
48098

6 Chicago
85 W Algonquin - Suite 340
Arlington Heights, IL
60005

8 Silicon Valley
4935 Southfront Road, Suite F
Livermore, CA
94550

Festo Regional Contact Center

Canadian Customers

Commercial Support:
Tel: 1 877 GO FESTO (1 877 463 3786)
Fax: 1 877 FX FESTO (1 877 393 3786)
Email: festo.canada@ca.festo.com

Technical Support:
Tel: 1 866 GO FESTO (1 866 463 3786)
Fax: 1 877 FX FESTO (1 877 393 3786)
Email: technical.support@ca.festo.com

USA Customers

Commercial Support:
Tel: 1 800 99 FESTO (1 800 993 3786)
Fax: 1 800 96 FESTO (1 800 963 3786)
Email: customer.service@us.festo.com

Technical Support:
Tel: 1 866 GO FESTO (1 866 463 3786)
Fax: 1 800 96 FESTO (1 800 963 3786)
Email: product.support@us.festo.com