

Inscription labels ASLR

Technical data

Inscription label KM-BZ, IBS, KMC, MH, ASLR

Inscription labels for identification, can be used in holders or carriers on suitably equipped components.

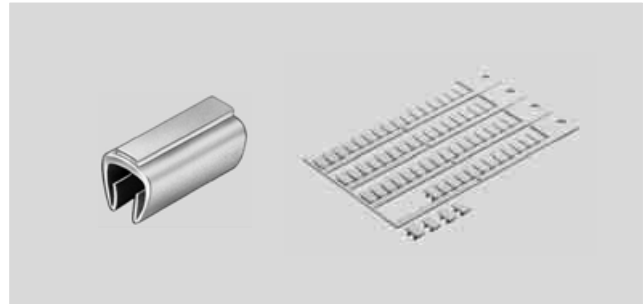

General technical data					
Type	KM-BZ	IBS	KMC/F	MH	ASLR
Type of mounting	Inscription label holder is pressed onto a cable	Pressed into inscription label holders or suitable slots on the components		Label (self-adhesive) is on the component	
Labelling	The inscription label holder itself is not labelled. The inscription consists of an insertable label or paper/ cardboard strips	By the user directly on the inscription label		The inscription label holder already has a label.	
Cable diameter [mm]	5 ... 8	-		-	



Materials						
Type	KM-BZ	IBS	IBS-8x20	KMC/F	MH	ASLR
Inscription label holders	-	PA	PA	PA	PC	-
Note on materials	-	-	RoHS-compliant	-	-	RoHS-compliant

- 1 - Type to be discontinued
Available until 2017

FESTO

Inscription labels ASLR

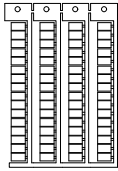
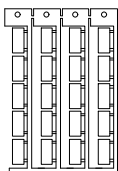
Technical data

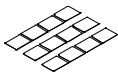
Ordering data					
	Description	Dimensions (HxW) [mm]	Scope of delivery	Part No.	Type
	Inscription clips for placing on a cable	11x20	1	33361	KM-BZ
	Inscription labels for pressing into a holder	6x10	64 (number per frame)	18576	IBS-6x10
		9x17	24 (number per frame)	161937	IBS-9x17
	Inscription labels for pressing into a holder	8x20	20 (number per frame)	539388	IBS-8x20
		9x20	20 (number per frame)	18182	IBS-9x20
		10x17	30 (number per frame)	160238	IBS-10x17
	Inscription labels for pressing into a holder	11/8x17	35 (number per frame)	33362	KMC/F/V-BZ-35X
	Inscription labels for pressing into a holder	4.5x9	80 (number per frame)	197259	MH-BZ-80X
	Inscription label holder, labelled <ul style="list-style-type: none"> • 4 inscription labels, duct 1/3/5 • 4 inscription labels, duct 1 • 4 inscription labels, duct 3/5 	20x16	3x4 pieces	8003303	ASLR-L-S6-2016

Product Range and Company Overview

A Complete Suite and Company Overview

Our experienced engineers provide complete support at every stage of your development process, including: conceptualization, analysis, engineering, design, assembly, documentation, validation, and production.



Custom Automation Components
Complete custom engineered solutions



Custom Control Cabinets
Comprehensive engineering support and on-site services



Complete Systems
Shipment, stocking and storage services

The Broadest Range of Automation Components

With a comprehensive line of more than 30,000 automation components, Festo is capable of solving the most complex automation requirements.



Electromechanical
Electromechanical actuators, motors, controllers & drivers



Pneumatics
Pneumatic linear and rotary actuators, valves, and air supply



PLCs and I/O Devices
PLC's, operator interfaces, sensors and I/O devices

Supporting Advanced Automation... As No One Else Can!

Festo is a leading global manufacturer of pneumatic and electromechanical systems, components and controls for industrial automation, with more than 16,000 employees in 60 national headquarters serving more than 180 countries. For more than 80 years, Festo has continuously elevated the state of manufacturing with innovations and optimized motion control solutions that deliver higher performing, more profitable automated manufacturing and processing equipment. Our dedication to the advancement of automation extends beyond technology to the education and development of current and future automation and robotics designers with simulation tools, teaching programs, and on-site services.

Quality Assurance, ISO 9001 and ISO 14001 Certifications

Festo Corporation is committed to supply all Festo products and services that will meet or exceed our customers' requirements in product quality, delivery, customer service and satisfaction.

To meet this commitment, we strive to ensure a consistent, integrated, and systematic approach to management that will meet or exceed the requirements of the ISO 9001 standard for Quality Management and the ISO 14001 standard for Environmental Management.



© Copyright 2013, Festo Corporation. While every effort is made to ensure that all dimensions and specifications are correct, Festo cannot guarantee that publications are completely free of any error, in particular typing or printing errors. Accordingly, Festo cannot be held responsible for the same. For Liability and Warranty conditions, refer to our "Terms and Conditions of Sale", available from your local Festo office. All rights reserved. No part of this publication may be reproduced, distributed, or transmitted in any form or by any means, electronic, mechanical, photocopying or otherwise, without the prior written permission of Festo. All technical data subject to change according to technical update.



Printed on recycled paper at New Horizon Graphic, Inc., FSC certified as an environmental friendly printing plant.

Festo North America

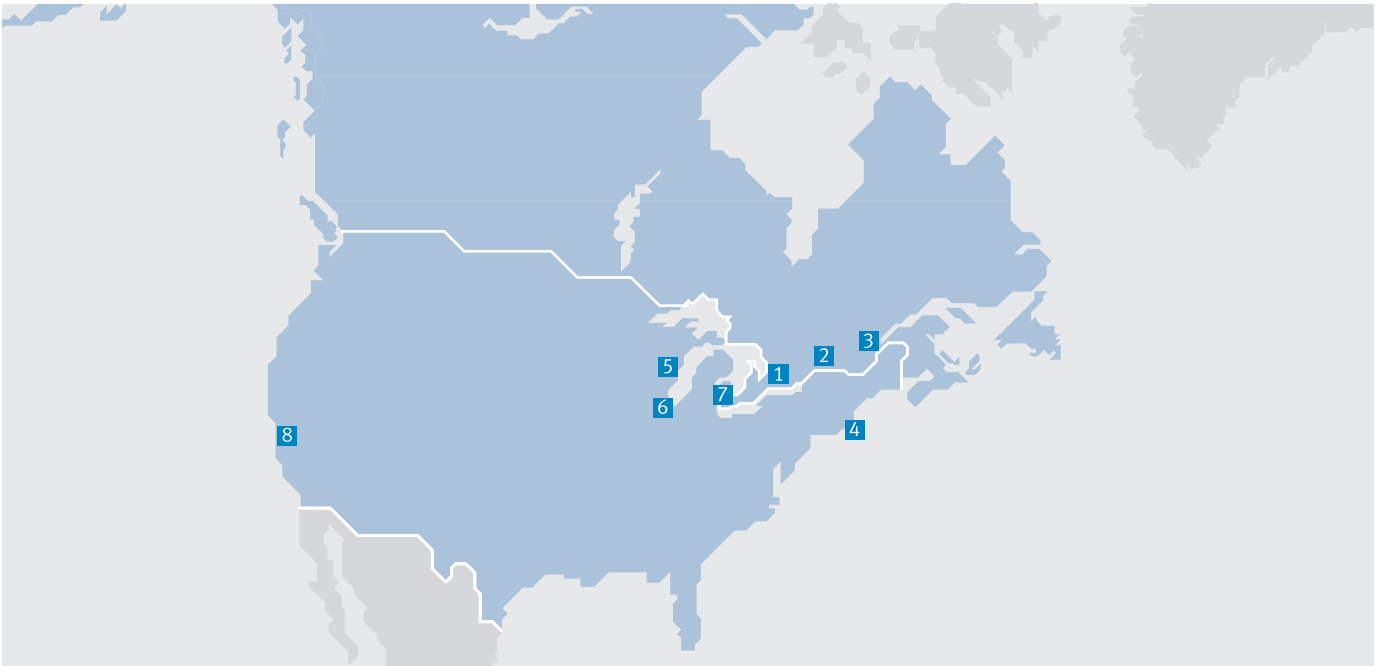

**1 Festo Canada
Headquarters
Festo Inc.**
5300 Explorer Drive
Mississauga, ON
L4W 5G4

2 Montréal
5600, Trans-Canada
Pointe-Claire, QC
H9R 1B6

3 Québec City
2930, rue Watt#117
Québec, QC
G1X 4G3



**4 Festo United States
Headquarters
Festo Corporation**
395 Moreland Road
Hauppauge, NY
11788

5 Appleton
North 922 Tower View Drive, Suite N
Greenville, WI
54942

7 Detroit
1441 West Long Lake Road
Troy, MI
48098

6 Chicago
85 W Algonquin - Suite 340
Arlington Heights, IL
60005

8 Silicon Valley
4935 Southfront Road, Suite F
Livermore, CA
94550

Festo Regional Contact Center

Canadian Customers

Commercial Support:
Tel: 1 877 GO FESTO (1 877 463 3786)
Fax: 1 877 FX FESTO (1 877 393 3786)
Email: festo.canada@ca.festo.com

Technical Support:
Tel: 1 866 GO FESTO (1 866 463 3786)
Fax: 1 877 FX FESTO (1 877 393 3786)
Email: technical.support@ca.festo.com

USA Customers

Commercial Support:
Tel: 1 800 99 FESTO (1 800 993 3786)
Fax: 1 800 96 FESTO (1 800 963 3786)
Email: customer.service@us.festo.com

Technical Support:
Tel: 1 866 GO FESTO (1 866 463 3786)
Fax: 1 800 96 FESTO (1 800 963 3786)
Email: product.support@us.festo.com