

# Control blocks for two-hand start ZSB

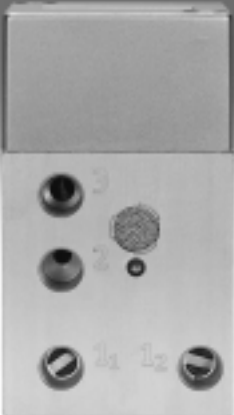

# Control blocks for two-hand start ZSB

Key features



## Function

This pneumatic control block for two-hand start ZSB is used where a manually started operation, such as the triggering of compressed air cylinders, would otherwise involve danger for a machine operator, or with other devices where machine operators have to have both hands clear of a danger zone when starting a machine.

The ZSB will only switch if pressure is applied simultaneously via 3/2-way pushbutton valves to the two inlet ports 1<sub>1</sub> and 1<sub>2</sub> of the ZSB, i.e. within max. 0.5 seconds, and if there is an output signal at port 2. If both pushbutton valves are activated, outlet port 2 is pressurised.

Releasing one or both pushbutton valves interrupts the flow immediately and the outlet port 2 becomes unpressurised. The system vents from 2 to 3.

The pneumatic control block for two-hand start is a safety component in accordance with the EU Machinery Directive.

It falls within Category 1, PL "c" according to EN ISO 13849-1 and conforms to Type III A according to EN 574.

## Sample circuit

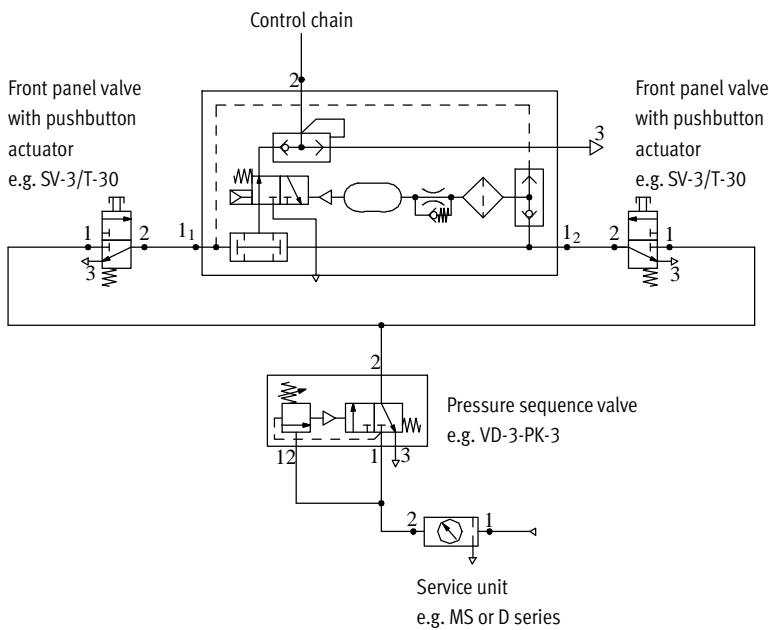

- - Note

When installing the two pushbutton valves which actuate the control block for two-hand start, make sure that the protective function cannot easily be bypassed, for example by pressing the pushbutton valves with the hand and elbow of the same arm. If necessary, the pushbutton valves should be fitted with an additional guard plate.

# Control blocks for two-hand start ZSB

Peripherals overview

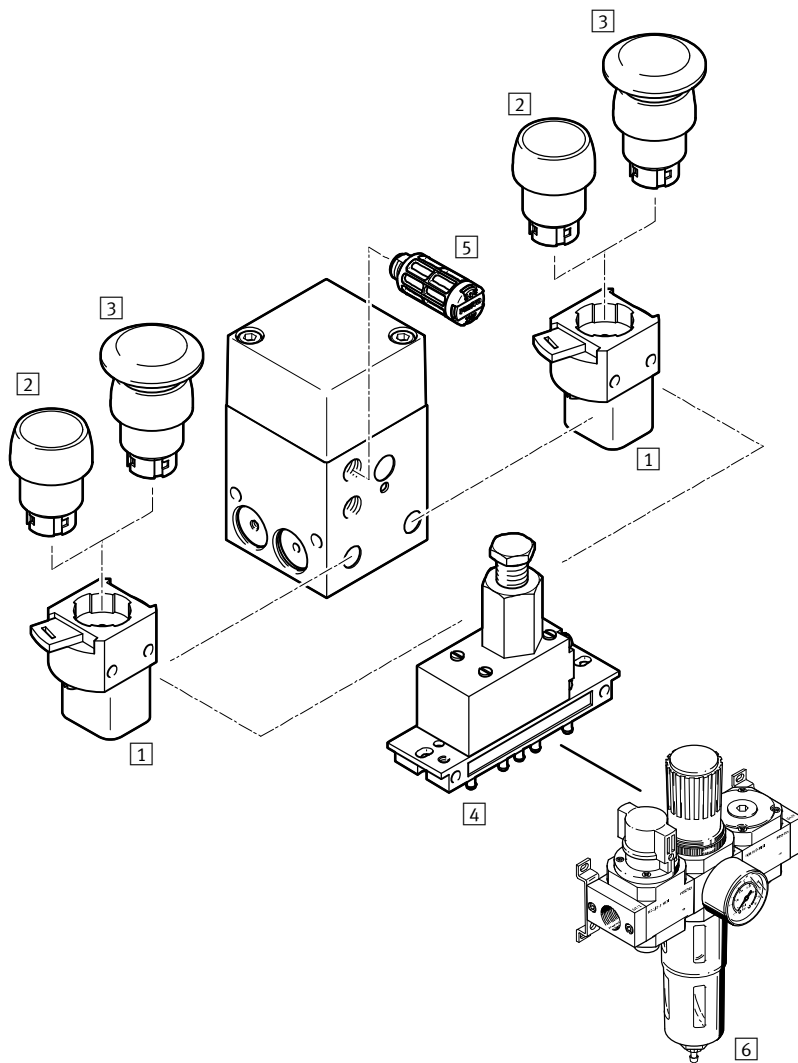

Accessories		Brief description	→ Page/Internet
1	Front panel valve SV	Poppet valve with quick latching coupler for actuator attachments	6
2	Pushbutton actuator T	Actuator attachment for front panel valve SV	6
3	Mushroom pushbutton P	Actuator attachment for front panel valve SV	6
4	Pressure sequence valve VD	For ensuring the minimum pressure of 4 bar required for operation	6
5	Silencer U	For noise reduction at the exhaust port	6
6	Service unit combination – D series – MS series	For compressed air preparation	lfr*k* msb



# Control blocks for two-hand start ZSB

FESTO

Technical data

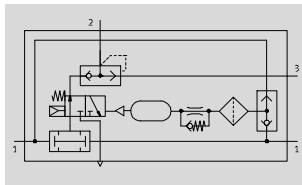
Function



-  - Flow rate  
up to 50 l/min
-  - Temperature range  
0 ... +60°C
-  - Operating pressure  
4 ... 8 bar



Safety data	
Lift	Two-hand operation in accordance with EN ISO 12100
Performance Level (PL)	Two-hand operation: Category 1, PL c according to EN ISO 13849-1
Safety Integrity Level (SIL)	Two-hand operation: SIL 1 according to IEC 61508 (can be used in SIL 1 controllers according to IEC 62061)
Reliable component	Yes
Standard approval	Type III A according to EN 574
Certificate issuing authority	IFA 1201046
CE marking (see declaration of conformity)	To EU Machinery Directive
Shock resistance	Shock test with severity level 2 according to FN 942017-5 and EN 60068-2-27

General technical data	
Pneumatic connection	G $\frac{1}{8}$
Nominal size [mm]	4
Actuation type	Pneumatic
Design	Poppet valve with spring return
Type of mounting	Via through-hole Via female thread
Mounting position	Any
Standard nominal flow rate [l/min]	50
Product weight [g]	420

Operating and environmental conditions	
Operating pressure [bar]	4 ... 8
Operating medium	Compressed air in accordance with ISO 8573-1:2010 [7:4:4]
Note on operating/pilot medium	Operation with lubricated medium possible (in which case lubricated operation will always be required)
Ambient temperature [°C]	0 ... +60
Corrosion resistance class CRC <sup>1)</sup>	1
CE mark (see declaration of conformity)	To EU Machinery Directive

1) Corrosion resistance class CRC 1 to Festo standard FN 940070  
Low corrosion stress. For dry indoor applications or transport and storage protection. Also applies to parts behind covers, in the non-visible interior area, and parts which are covered in the application (e.g. drive trunnions).

Materials	
Housing	Anodised wrought aluminium alloy
End cap	Die-cast aluminium
Seals	NBR
Note on materials	RoHS-compliant

# Control blocks for two-hand start ZSB

Technical data

## Dimensions

Download CAD data → [www.festo.com](http://www.festo.com)

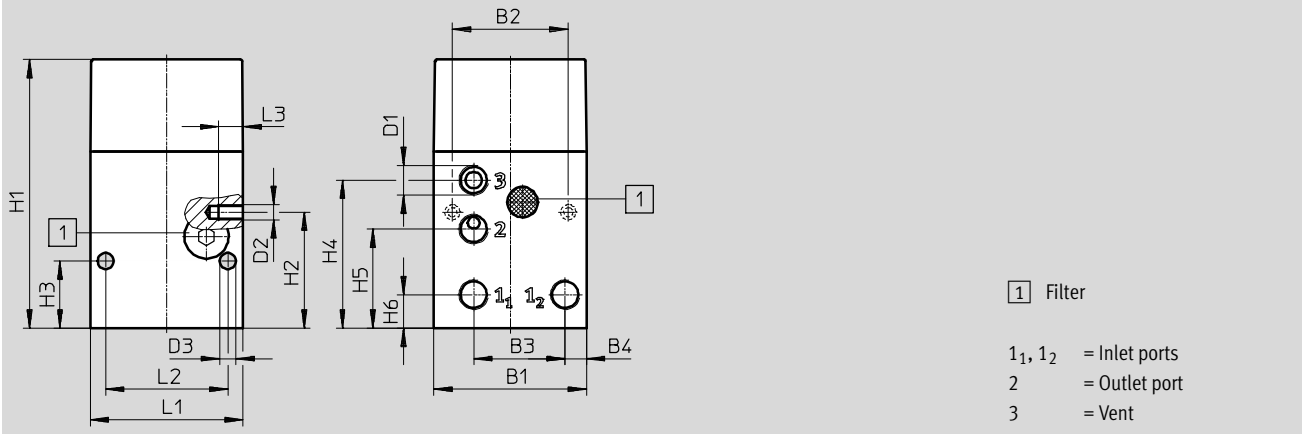

B1	B2	B3	B4	D1	D2	D3 Ø	H1	H2	H3	H4	H5	H6	L1	L2	L3
50	38	30.1	7	G1/8	M5	5.3	88	38	22	48.5	32.5	11	50	40	8

## Ordering data

	Part No.	Type
Control block for two-hand start	576656	ZSB-1/8-B

# Control blocks for two-hand start ZSB

Accessories

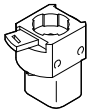
Ordering data – Front panel valve SV				Technical data → Internet: sv	
	Pneumatic connection	Valve function	Operating pressure [bar]	Part No.	Type
	M5	3/2-way valve, single solenoid, closed	-0.95 ... 8	<b>6817</b>	<b>SV-3-M5</b>

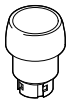
Ordering data – Pushbutton actuator T			Technical data → Internet: t	
	Colour	Installation diameter [mm]	Part No.	Type
	Black	22.5	<b>9289</b>	<b>T-22-SW</b>
		30.5	<b>9291</b>	<b>T-30-SW</b>

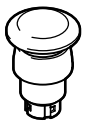
Ordering data – Mushroom pushbutton P			Technical data → Internet: p	
	Colour	Installation diameter [mm]	Part No.	Type
	Black	22.5	<b>9293</b>	<b>P-22-SW</b>
		30.5	<b>9295</b>	<b>P-30-SW</b>

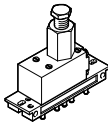
Ordering data – Pressure sequence valve VD				Technical data → Internet: vd	
	Pneumatic connection	Valve function	Operating pressure [bar]	Part No.	Type
	PK-3	3/2-way valve, normally closed, adjustable switching pressure	1.8 ... 8	<b>9270</b>	<b>VD-3-PK-3</b>

Ordering data – Silencer U			Technical data → Internet: u	
	Pneumatic connection	Material	Part No.	Type
	G1/8	Polyacetal	<b>2307</b>	<b>U-1/8</b>
		Die-cast aluminium	<b>6841</b>	<b>U-1/8-B</b>