

Pneumatic valves VUWG



Pneumatic valves VUWG

Key features

FESTO

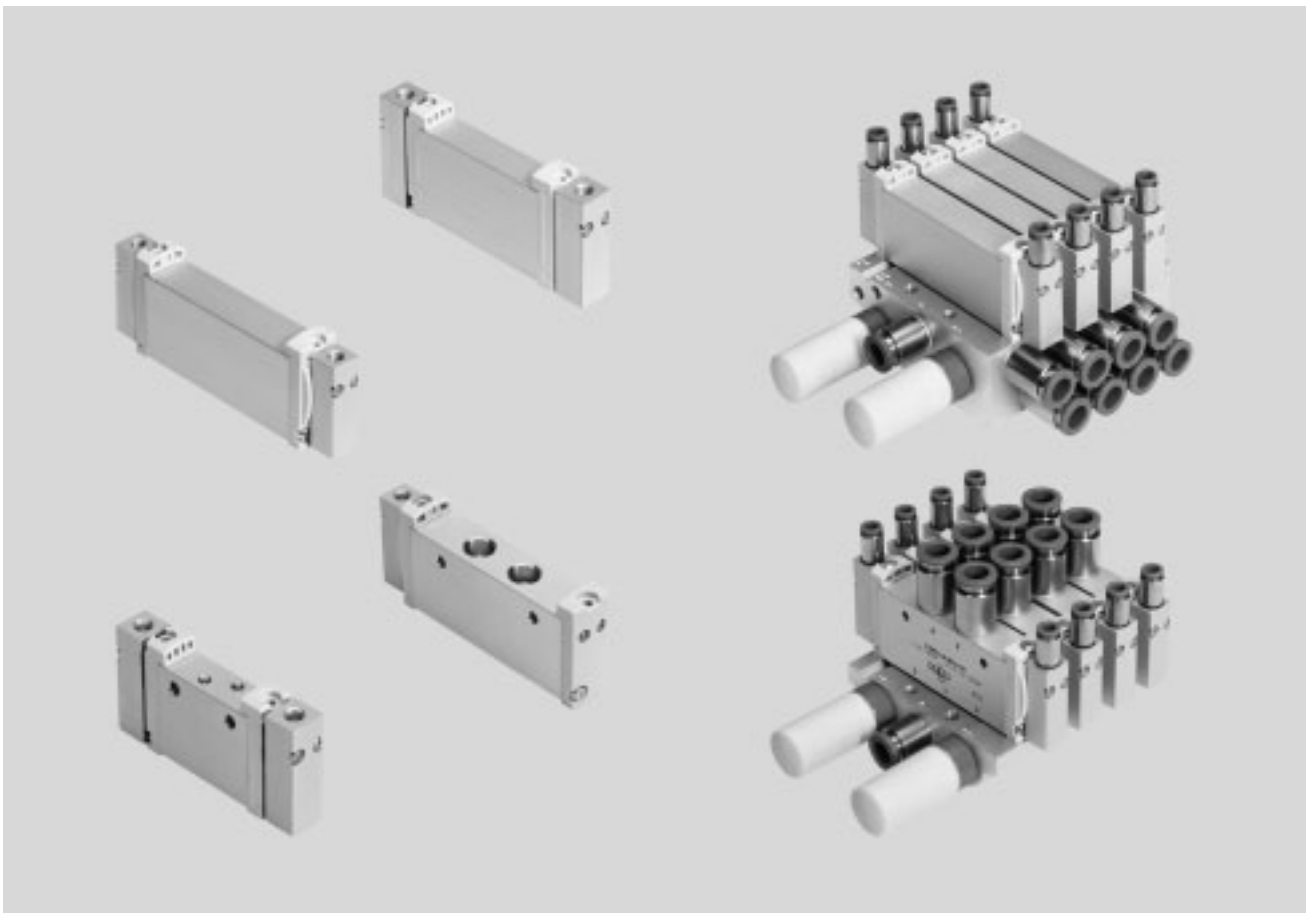

Innovative

- Various connection sizes (M3, M5, M7, G $\frac{1}{8}$, G $\frac{1}{4}$)
- Max. pressure 10 bar
- 2x3/2-way valve in one valve housing

Versatile

- Wide range of valve functions
- In-line valves can be used as individual valves or manifold valves
- M5/M7 in-line valves can be mixed on one manifold rail
- Identical sub-base valves for M5 or M7 manifold rail
- Manifolds with pressure zones
- Choice of quick push-in connectors

Reliable

- Sturdy and durable metal components
 - Valves
 - Manifold rails
- Reliable servicing thanks to valves that can be replaced quickly and easily

Easy to mount

- Secure mounting on wall or H-rail
- Easy mounting thanks to captive screws and seals

Pneumatic valves VUWG

Key features – Pneumatic components

Individual valves and valve manifolds

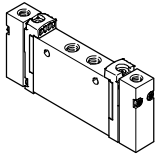

VUWG-L in-line valve as individual valve

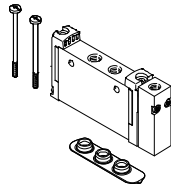

VUWG-S in-line valve for manifold assembly

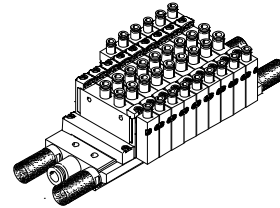

VUWG-S valve manifold consisting of in-line valves

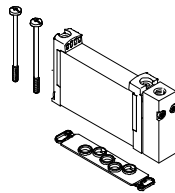

VUWG-B sub-base valve for manifold assembly

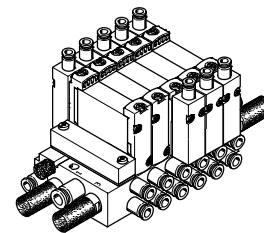

VUWG-B valve manifold consisting of sub-base valves

VUWG basic valves

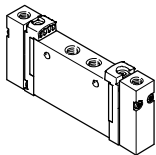

- Width 10, 14 and 18 mm
- 2x 3/2-way, 5/2-way and 5/3-way valves
- In-line valves
- Sub-base valves

Pneumatic valves VUWG

Key features – Pneumatic components



Manifold rail for in-line valves

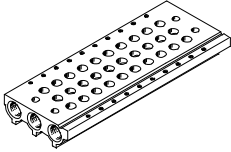

- For in-line valves M3, M5, M7, G $\frac{1}{8}$ and G $\frac{1}{4}$, width 10/14/18
- For 2x3/2-way, 5/2-way and 5/3-way valves
- 2 to 10 and 12, 14, 16 valve positions

Manifold rail for sub-base valves

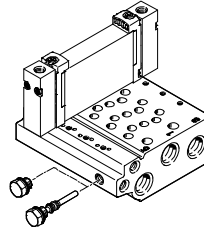

- For sub-base valves 10A, 10, 14 and 18, width 10/14/18
- Manifold rail with M3, M5/M7, G $\frac{1}{8}$ and G $\frac{1}{4}$ working ports
- For 2x3/2-way, 5/2-way and 5/3-way valves
- 2 to 10, 12, 14 and 16 valve positions
- The sub-base valves always have external pilot air. The pilot air is set via the manifold rail. A short (for internal pilot air) and long (for external pilot air) blanking plug are included with the manifold rail for this purpose.

Note

Duct 84 must not be sealed by a blanking plug when connecting a sub-base valve.

Blanking plate for vacant position



For covering unused valve positions

Supply plate



For additional air supply and exhaust via a valve position

Separator for pressure zones



For creating multiple pressure zones

Pilot pressure p₂ as a function of operating pressure p₁

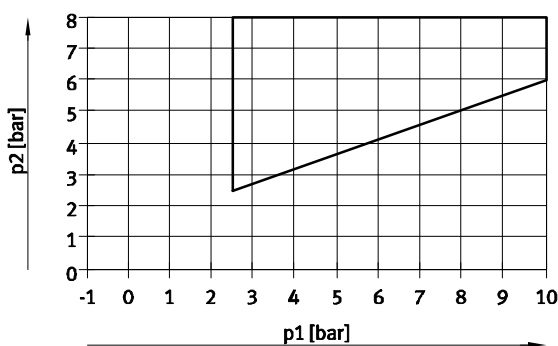

This graph applies to the 2x3/2-way valves and 5/2-way single pilot valves with air spring:

- T32CA, T32UA, T32HA
- M52A, M52R

Note

The compressed air for the air spring is supplied from port 1 (operating pressure). To ensure reliable valve switching, the minimum pressure as per the graph must always be adhered to for the pilot pressure.

Pneumatic valves VUWG

Key features – Pneumatic components

Creating pressure zones and separating exhaust air

Compressed air is supplied and exhausted via the manifold rail and supply plates.

The position of the supply plates and duct separations can be freely selected with the VUWG.

Pressure zones are created by isolating the internal supply ducts between the manifold sub-bases by means of appropriate duct separation.

Pressure zone separation can be used for the following ducts:

- Duct 1
- Duct 3
- Duct 5

 Note

- Use separators if the exhaust air pressures are high
- Use at least one supply plate/supply for each pressure zone

Duct separation

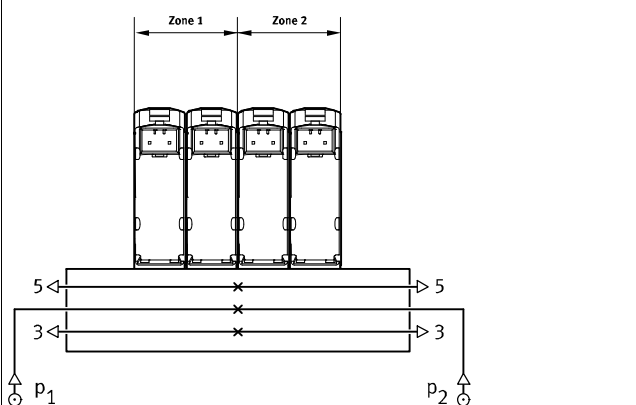
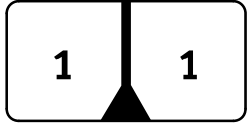
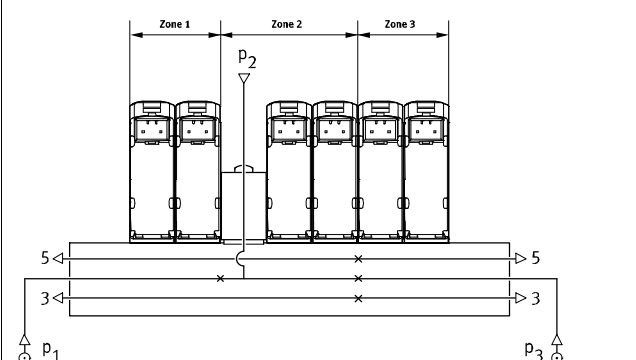
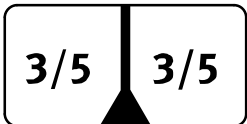
	Description	Symbol
	<p>The pressure zones can be freely configured with the VUWG. The following duct separations are possible:</p> <ul style="list-style-type: none"> • Duct 1 closed 	
	<p>The number of pressure zones with the VUWG is only limited by the number of valve positions on the manifold rail. Note that each supply plate occupies one valve position.</p>	

Separator VABD

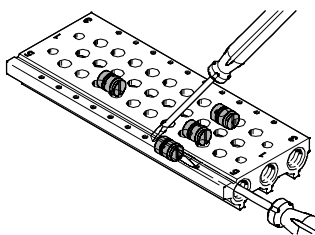

 Note

As the separators are mounted from only one side using a slotted screwdriver, several pressure zones can be created in one profile.

Pneumatic valves VUWG

Key features – Pneumatic components

Flow control valve

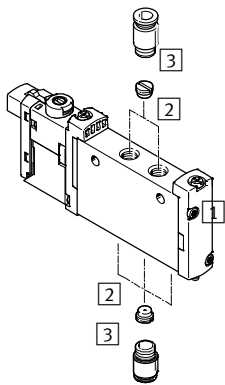

- 1 Valve
- 2 Flow control valve
- 3 Fitting

Flow control mountable on port 1, 3/5 and/or on port 2/4.

Operation with different pressures

Vacuum operation

Note the following with vacuum operation:

- M52 in-line valves with pneumatic spring and pneumatic/mechanical spring reset (vacuum only at 3/5)
- T32 valves with pneumatic spring reset (vacuum only at 3/5)

If external pilot air via duct 14 is used, M52 sub-base valves (B) can be used without restriction.

The remaining valve types can be used without restriction for vacuum.

Reverse operation

The valves with pneumatic spring are not suitable for reverse operation, since at least the minimum pilot pressure must be present in duct 1.



Note

Pressure must be present at port 1.

Pressure deflector (internal pilot air)

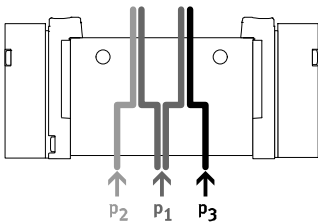

- If two different pressures are required.

- Different pressures can be supplied at duct 1, 3 and 5.



Note

- With internal pilot air, the minimum pilot pressure must be adhered to in duct 1

- With 2x3/2-way valves without spring return, the minimum pilot pressure must always be adhered to in duct 1

Advantages

Any pressure or vacuum can be connected at ducts 3 and 5 both with external and internal pilot air.

Vacuum, ejector pulse and normal position

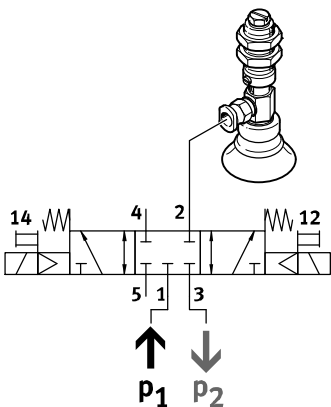

Vacuum, ejector pulse and normal position with internal pilot air can be achieved by connecting vacuum

at duct 3 and pressure for the ejector pulse at duct 1.

Pneumatic valves VUWG

Product range overview

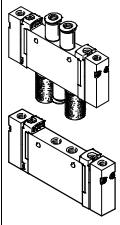
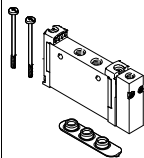
Design	Working port	Valve code	Functions and flow rate [l/min]												→ Page/ Internet
			T32C	T32U	T32H	T32C/M	T32U/M	T32H/M	M52	M52/M	B52	P53C	P53U	P53E	
In-line valve as individual valve, VUWG-L															
	M3	10A	-	-	-	-	-	-	100	80	100	90	90	90	12
	M5	10	■	■	■	■	■	■	■	■	■	■	■	■	18
	M7	10	150	150	150	135	125	125	220	190	220	210	210	210	18
	G1/8	14	■	■	■	■	■	■	■	■	■	■	■	■	28
	G1/4	18	650	600	650	550	500	500	780	780	780	650	600	600	35
			1,000	1,000	1,000	1,000	1,000	1,000	1,300	1,300	1,380	1,200	1,200	1,200	
In-line valve for manifold assembly, VUWG-S															
	M3	10A	-	-	-	-	-	-	100	80	100	90	90	90	15
	M5	10	■	■	■	■	■	■	■	■	■	■	■	■	25
	M7	10	150	150	150	135	125	125	220	190	220	210	210	210	25
	G1/8	14	■	■	■	■	■	■	■	■	■	■	■	■	32
	G1/4	18	620	580	580	520	480	480	730	730	730	620	580	580	39
			1,000	1,000	1,000	1,000	1,000	1,000	1,300	1,300	1,380	1,200	1,200	1,200	

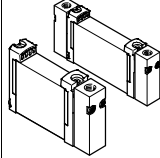
Design	Working port	Type code	Functions and flow rate [l/min]												→ Page/ Internet
			T32C	T32U	T32H	T32C/M	T32U/M	T32H/M	M52	M52/M	B52	P53C	P53U	P53E	
Sub-base valve, VUWG-B															
	-	10 A	-	-	-	-	-	-	100	80	100	90	90	90	42
	-	10	■	■	■	■	■	■	■	■	■	■	■	■	47
	-	10	150	150	150	130	120	120	210	180	210	200	200	200	47
	-	14	■	■	■	■	■	■	■	■	■	■	■	■	52
	-	18	160	160	160	140	130	130	270	230	270	250	250	250	57
			540	510	540	430	410	410	580	580	580	540	510	510	
			900	900	900	900	900	900	1,000	1,000	1,000	950	950	950	

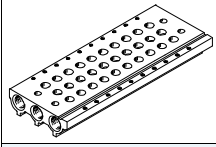
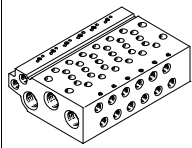
Design	Working port	Type code	Description	→ Page/ Internet
Manifold rail VABM- ... -S- ... , for in-line valves (manifold assembly)				
	-	-	Valve size M3, M5, M7, G1/8, G1/4	vabm
Manifold rail VABM, for sub-base valves				
	-	10AW	Connection size M3	vabm
	-	10W	Connection size M5	
	-	10HW	Connection size M7	
	-	14W	Connection size G1/8	
	-	18W	Connection size G1/4	

Pneumatic valves VUWG

Overview of valve functions



Valve	Valve code	Description	Valve terminal/ position function order code	Size			
				M3	M5/M7	G1/8	G1/4
2x 3/2-way valve, normally closed, pneumatic spring							
	T32C-A	External pilot air supply	K	-	■	■	■
2x 3/2-way valve, normally open, pneumatic spring							
	T32U-A	External pilot air supply	N	-	■	■	■
2x 3/2-way valve, 1x normally open, 1x normally closed, pneumatic spring							
	T32H-A	External pilot air supply	H	-	■	■	■
2x3/2-way valve, normally closed, mechanical spring							
	T32C-M	External pilot air supply	VK	-	■	■	■
2x3/2-way valve, normally open, mechanical spring							
	T32U-M	External pilot air supply	VN	-	■	■	■
2x3/2-way valve, 1x normally open, 1x normally closed, mechanical spring							
	T32H-M	External pilot air supply	VH	-	■	■	■
5/2-way valve, double pilot							
	B52	External pilot air supply	J	■	■	■	■
5/2-way valve, single pilot, mechanical spring							
	M52-M	External pilot air supply	A	■	■	■	■
5/2-way valve, single pilot, pneumatic spring							
	M52-A	In-line valve, external pilot air supply	M	-	-	■	-
5/2-way valve, single pilot, pneumatic/mechanical spring							
	M52-R	In-line valve, external pilot air supply	P	■	■	-	■
5/2-way valve, single pilot, pneumatic spring							
	M52-A	Sub-base valve, external pilot air supply	M	-	-	■	-
5/2-way valve, single pilot, pneumatic/mechanical spring							
	M52-R	Sub-base valve, external pilot air supply	P	■	■	-	■

Pneumatic valves VUWG

Overview of valve functions

Valve	Valve code	Description	Valve terminal/ position function order code	Size			
				M3	M5/M7	G1/8	G1/4
5/3-way valve, mid-position closed							
	P53C	External pilot air supply	G	■	■	■	■
5/3-way valve, mid-position pressurised							
	P53U	External pilot air supply	B	■	■	■	■
5/3-way valve, mid-position exhausted							
	P53E	External pilot air supply	E	■	■	■	■

Pneumatic valves VUWG

Sample system overview – VUWG-L10 and VUWG-S10, in-line valves M5/M7

FESTO

Manifold assembly

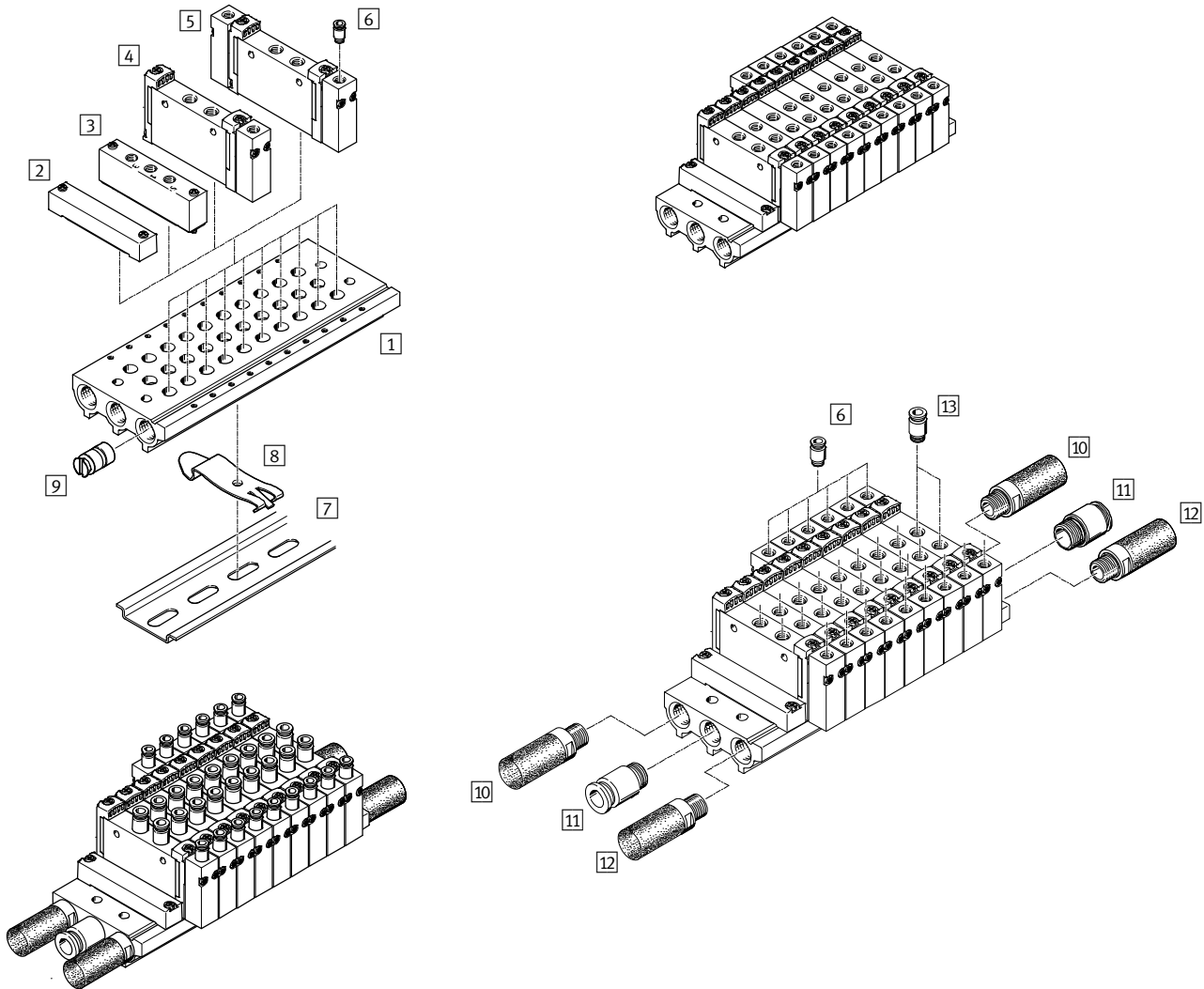

Manifold assembly and accessories			
	Type	Brief description	→ Page/Internet
1	VABM-L1-10S-G18	For 2 to 10, 12, 14 and 16 valve positions	26
2	VABB-L1-10-S	For covering an unused valve position	27
3	VABF-L1-10-P3A4	For air supply port 1 and ports 3 and 5	27
4	VUWG	Single pilot pneumatic valve	18
5	VUWG	Double pilot pneumatic valve	18
6	QS	For adapter plate for port 12 or 14	62
7	NRH-35-2000	For mounting the valve manifold	62
8	VAME-T-M4	2 pieces for fitting the valve manifold on an H-rail	62
9	VABD-8-B	For creating pressure zones	62
10	U	For port 3	62
11	QS	For port 1	62
12	U	For port 5	62
13	QS	For ports 2 and 4	62

Pneumatic valves VUWG

Sample system overview – VUWG-B10, sub-base valves

Manifold assembly

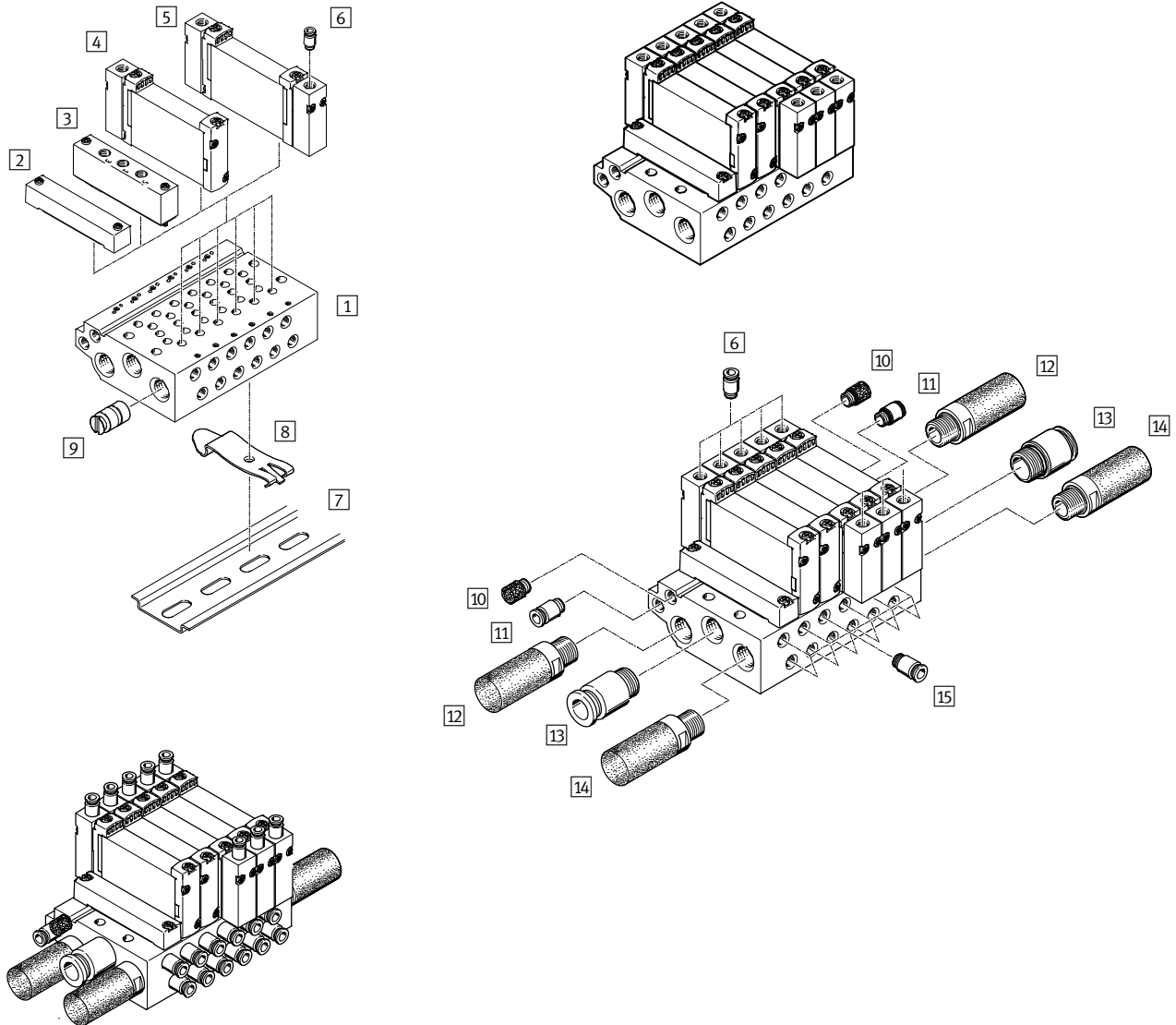



Manifold assembly and accessories				
	Type	Brief description	→ Page/Internet	
1	Manifold rail	VABM-L1-10W-G18	For 2 to 10, 12, 14 and 16 valve positions	51
2	Blanking plate	VABB-L1-10-W	For covering an unused valve position	51
3	Supply plate	VABF-L1-10-P3A4-M5	For air supply port 1 and ports 3 and 5	51
4	Pneumatic valve	VUWG	Single pilot pneumatic valve	47
5	Pneumatic valve	VUWG	Double pilot pneumatic valve	47
6	Push-in fitting	QS	For adapter plate for port 12 or 14	62
7	H-rail	NRH-35-2000	For mounting the valve manifold	62
8	H-rail mounting	VAME-T-M4	2 pieces for fitting the valve manifold on an H-rail	62
9	Separator	VABD-6-B	For creating pressure zones	51
10	Silencer	U	For port 84	62
11	Push-in fitting	QS	For port 14	62
12	Silencer	U	For port 5	62
13	Push-in fitting	QS	For port 1	62
14	Silencer	U	For port 3	62
15	Push-in fitting	QS	For ports 2 and 4	62

Pneumatic valves VUWG-L10A, in-line valves M3

Technical data

Function
 5/2-way, single pilot
 5/2-way, double pilot
 5/3C, 5/3U, 5/3E

-  - Width 10 mm
 -  - Flow rate
 80 ... 100 l/min



General technical data					
Valve function	M52-R	B52	M52-M	P53	
Normal position	-	-	-	C ¹⁾	U ²⁾ E ³⁾
Pneumatic spring reset method	Yes ⁴⁾	-	No	No	
Mechanical spring reset method	Yes ⁴⁾	-	Yes	Yes	
Vacuum operation at port 1	No	Yes	Yes	Yes	
Vacuum operation at port 3/5	Yes				
Design	Piston spool valve				
Sealing principle	Soft				
Actuation type	Pneumatic				
Type of control	Direct				
Pilot air supply	External				
Exhaust function	With flow control				
Type of mounting	Optionally via through-holes ⁶⁾ or on manifold rail				
Mounting position	Any				
Standard nominal flow rate	[l/min]	100	80	90	
Switching time on/off	[ms]	5/11	-	5/16 7/19	
Changeover time	[ms]	-	5	-	
Width	[mm]	10			
Port	1, 2, 3, 4, 5	M3			
	12, 14	M5			
Product weight	[g]	37	40	34	40
Corrosion resistance class CRC ⁵⁾	2				

- 1) C = Normally closed
- 2) U = Normally open/mid-position pressurised
- 3) E = Normally exhausted
- 4) Combined reset method
- 5) Corrosion resistance class 2 according to Festo standard 940 070
 Components subject to moderate corrosion stress. Externally visible parts with primarily decorative surface requirements which are in direct contact with a normal industrial environment or media such as coolants or lubricating agents.
- 6) If several valves are to be screwed together via the through-holes to form a block, a minimum gap of 0.3 mm must be ensured by placing spacer discs between them.

Operating and environmental conditions					
Valve function	M52-R ³⁾	B52	M52-M ²⁾	P53	
Operating medium	Compressed air to ISO 8573-1:2010 [7:4:4]				
Note on operating/pilot medium	Lubricated operation possible (required during subsequent operation)				
Operating pressure	[bar]	2.5 ... 10	-0.9 ... 10	-0.9 ... 8	-0.9 ... 10
Pilot pressure ¹⁾	[bar]	2.5 ... 10	1.5 ... 10	3 ... 10	
Ambient temperature	[°C]	-5 ... +60			
Temperature of medium	[°C]	-5 ... +50			

- 1) Note operating pressure/pilot pressure graph → page 4
- 2) Mechanical spring
- 3) Mixed, pneumatic/mechanical spring

Pneumatic valves VUWG-L10A, in-line valves M3

Technical data

Information on materials	
Housing	Anodised aluminium
Seals	HNBR, NBR
Note on materials	RoHS-compliant

Dimensions Download CAD data → www.festo.com

5/2-way and 5/3-way valve

1 Ports 2, 4: M3 2 Port 14: M5 4 M2.5 mounting screw
3 Port 12: M5

Type	B1	B2	D1	D2	H1	H2	L1	L2	L3	L4	L5	L6	L7	L8	L9	L10
VUWG-L10A-...	10.3	3.6	M3	3.2	32.5	9.1	59.9	50.7	34.9	18.5	20.7	7	9	7.9	7.3	12.4
VUWG-L10A-M52-...							49.9									

Ordering data

	Description	Part No.	Type
In-line valve M3			
	5/2-way valve, monostable		
	External pilot air supply, reset method: mechanical/pneumatic spring	573795	VUWG-L10A-M52-R-M3
	External pilot air supply, reset method: mechanical spring	574250	VUWG-L10A-M52-M-M3
	5/2-way valve, bistable		
	External pilot air supply	573796	VUWG-L10A-B52-M3
	5/3-way valve		
	Mid-position closed, external pilot air supply	573797	VUWG-L10A-P53C-M3
	Mid-position exhausted, external pilot air supply	573798	VUWG-L10A-P53E-M3
Mid-position pressurised, external pilot air supply	573799	VUWG-L10A-P53U-M3	

Pneumatic valves VUWG-L10A and VUWG-S10A, in-line valves M3

Order code

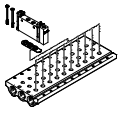
VUWG	-	10 A	-
Valve design			
In-line, individual valve		L	
			
In-line, manifold valve incl. seal and screws		S	
			
Width			
10 mm		10A	

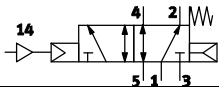
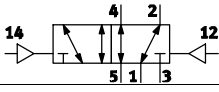
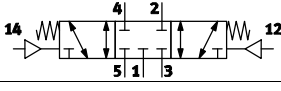
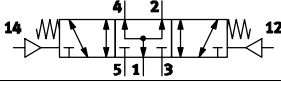
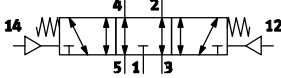
Valve functions	
	M52
	B52
	P53C
	P53U
	P53E

1) If Q... is chosen for the pneumatic connection, this also applies to the exhaust ports 3 and 5

2) Flow rate applies to 5/2-way individual valve

Exhausting with VUWG-L	
QN	Via fitting ¹⁾
U	Silencer
-	M3
Pneumatic connection	
M3	Thread M3
Q3	Push-in connector 3 mm/M3
Q4	Push-in connector 4 mm/M3
T18	Push-in connector 1/8"
T532	Push-in connector 3/32"
Flow rate [l/min]²⁾	
M3	100
Q3	80
Q4	100
T18	80
T532	100
Reset method	
M	Mechanical spring for M52
R	Pneu./mech. spring for M52
-	With B52 and P53

Pneumatic valves VUWG-S10A, in-line valves M3

Manifold assembly

In-line valves for manifold assembly



Dimensions

Download CAD data → www.festo.com

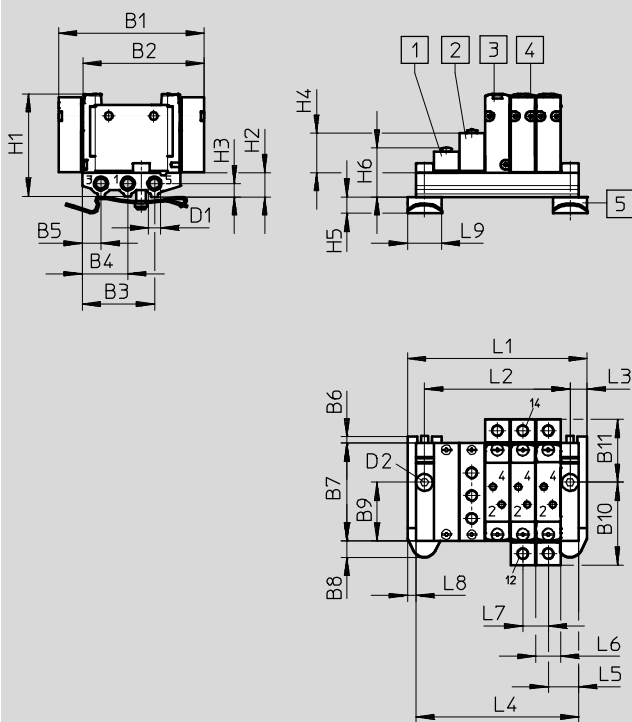

- 1 Blanking plate
VABB-L1-10A-S
- 2 Supply plate
VABF-L1-10A-P3A4-M5
- 3 Single pilot pneumatic valve
- 4 Double pilot pneumatic valve
- 5 H-rail mounting (two M4x15 screws to DIN 912 are required for mounting)

Type	B1	B2	B3	B4	B5	B6	B7	B8	B9	B10	B11	D1
VABM-L1-10AS-M5	59.9	49.9	29.7	18.7	7.7	2.95	40.3	6.75	24.2	34	25.9	M5

Type	D2	H1	H2	H3	H4	H5	H6	L3	L5	L6	L7	L8	L9
VABM-L1-10AS-M5	Ø 4.5	42.5	10	5.5	16.2	6.8	20.3	7	12.5	10.3	10.5	3.5	14

Valve positions	2	3	4	5	6	7	8	9	10	12	14	16
L1 [mm]	42.5	53	63.5	74	84.5	95	105.5	116	126.5	147.5	168.5	189.5
L2 [mm]	28.5	39	49.5	60	70.5	81	91.5	102	112.5	133.5	154.5	175.5
L4 [mm]	35.5	46	56.5	67	77.5	88	98.5	109	119.5	140.5	161.5	182.5

Pneumatic valves VUWG-S10A, in-line valves M3

Ordering data

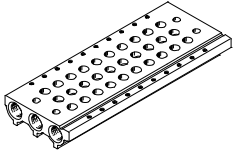
Technical data – Manifold rails							
	Port	CRC	Material ²⁾	Operating pressure [bar]	Max. tightening torque for assembly [Nm]		
	1, 3, 5				Valve	H-rail	Wall
	M5	2 ¹⁾	Wrought aluminium alloy	-0.9 ... 10	0.45	1.5	3

- 1) Corrosion resistance class 2 according to Festo standard 940 070
Components subject to moderate corrosion stress. Externally visible parts with primarily decorative surface requirements which are in direct contact with a normal industrial environment or media such as coolants or lubricating agents.
- 2) Note on materials: RoHS-compliant.





Order code – Manifold rails

VABM	-	L1	-	10A	S	-	M5	-	
Manifold assembly parts							Number of valve positions		
Manifold rail		VABM					2 to 10, 12, 14 and 16		
Valve series							Ports 1, 3, 5		
VUWG		L1					M5	M5	
Valve width									
10 mm				10A					
Manifold rail with ports 1, 3, 5									
For M3 in-line valves					S				

Pneumatic valves VUWG-S10A, in-line valves M3

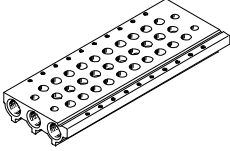
FESTO

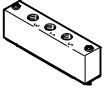
Ordering data

Ordering data – Accessories			
	Description	Part No.	Type
Manifold rail for in-line valves (manifold assembly)			
	For valve size M3	2 valve positions	566522 VABM-L1-10AS-M5-2
		3 valve positions	566523 VABM-L1-10AS-M5-3
		4 valve positions	566524 VABM-L1-10AS-M5-4
		5 valve positions	566525 VABM-L1-10AS-M5-5
		6 valve positions	566526 VABM-L1-10AS-M5-6
		7 valve positions	566527 VABM-L1-10AS-M5-7
		8 valve positions	566528 VABM-L1-10AS-M5-8
		9 valve positions	566529 VABM-L1-10AS-M5-9
		10 valve positions	566530 VABM-L1-10AS-M5-10
		12 valve positions	566531 VABM-L1-10AS-M5-12
		14 valve positions	566532 VABM-L1-10AS-M5-14
16 valve positions	566533 VABM-L1-10AS-M5-16		
Blanking plate Technical data → Internet: vabb			
	For manifold rail for M3 in-line valves	Incl. screws and seal	569986 VABB-L1-10A
Separator Technical data → Internet: vabd			
	For manifold rail for M3 in-line valves	Separator for pressure zones	570872 VABD-4.2-B
Supply plate Technical data → Internet: vabf			
	For manifold rail for M3 in-line valves	Incl. screws and seal	569990 VABF-L1-10A-P3A4-M5
Seals for in-line valves Technical data → Internet: vabd			
	M3	Delivery unit: 10 sets (each with 2 screws and 1 seal)	566670 VABD-L1-10AX-S-M3

Pneumatic valves VUWG-L10 and VUWG-S10, in-line valves M5

FESTO

Technical data

Function
 2x3/2C, 2x3/2U, 2x3/2H
 5/2-way, single pilot
 5/2-way, double pilot
 5/3C, 5/3U, 5/3E

-  - Width 10 mm

-  - Flow rate
 125 ... 220 l/min



General technical data											
Valve function	T32-A			T32-M			M52-R	B52	M52-M	P53	
Normal position	C ¹⁾	U ²⁾	H ⁴⁾	C ¹⁾	U ²⁾	H ⁴⁾	-	-	-	C ¹⁾ U ²⁾ E ³⁾	
Pneumatic spring reset method	Yes			No			Yes ⁵⁾	-	No	No	
Mechanical spring reset method	No			Yes			Yes ⁵⁾	-	Yes	Yes	
Vacuum operation at port 1	No			Yes			No	Yes			
Vacuum operation at port 3/5	Yes										
Design	Piston spool valve										
Sealing principle	Soft										
Actuation type	Pneumatic										
Type of control	Direct										
Pilot air supply	External										
Exhaust function	With flow control										
Type of mounting	Optionally via through-holes ⁷⁾ or on manifold rail										
Mounting position	Any										
Standard nominal flow rate [l/min]	150			135		125	220		190	210	
Switching time on/off [ms]	4/9			6/7			6/12		-	7/16	8/25
Changeover time [ms]	-			-			5		-	11	
Width [mm]	10										
Port	1, 2, 3, 4, 5			M5							
	12, 14			M5							
Product weight [g]	48			51			45	48	41	48	
Corrosion resistance class CRC ⁶⁾	2										

- 1) C = Normally closed
- 2) U = Normally open/mid-position pressurised
- 3) E = Normally exhausted
- 4) H = 2x 3/2-way valve in one housing with 1x normally closed and 1x normally open
- 5) Combined reset method
- 6) Corrosion resistance class 2 according to Festo standard 940 070
 Components subject to moderate corrosion stress. Externally visible parts with primarily decorative surface requirements which are in direct contact with a normal industrial environment or media such as coolants or lubricating agents.
- 7) If several valves are to be screwed together via the through-holes to form a block, a minimum gap of 0.3 mm must be ensured by placing spacer discs between them.

Pneumatic valves VUWG-L10 and VUWG-S10, in-line valves M5

Technical data

Operating and environmental conditions						
Valve function	T32-A ²⁾	T32-M ³⁾	M52-R ⁴⁾	B52	M52-M ³⁾	P53
Operating medium	Compressed air to ISO 8573-1:2010 [7:4:4]					
Note on operating/pilot medium	Lubricated operation possible (required during subsequent operation)					
Operating pressure [bar]	1.5 ... 10	-0.9...10	2.5 ... 10	-0.9...10	-0.9...8	-0.9...10
Pilot pressure ¹⁾ [bar]	1.5 ... 10	2...10	2.5 ... 10	1.5 ... 10	3...10	
Ambient temperature [°C]	-5 ... +60					
Temperature of medium [°C]	-5 ... +50					

- 1) Note operating pressure/pilot pressure graph → page 4
- 2) Pneumatic spring
- 3) Mechanical spring
- 4) Mixed, pneumatic/mechanical spring

Information on materials	
Housing	Wrought aluminium alloy
Seals	HNBR, NBR
Note on materials	RoHS-compliant

Dimensions Download CAD data → www.festo.com

2x3/2-way, 5/2-way and 5/3-way valve

1 Ports 2, 4: M5 2 Port 14: M5 4 M2.5 mounting screw
3 Port 12: M5

Type	B1	D1	H1	H2	L1	L2	L3	L4	L5	L6	L7	L8	L9	L10
VUWG-L10-...	10.2	3.2	32.5	9.1	72	62.8	47	27	22.5	11	11	7.9	12	16
VUWG-L10-M52-...					62									

Pneumatic valves VUWG-L10 and VUWG-S10, in-line valves M5

Technical data

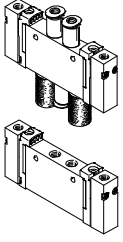
Ordering data		Part No.	Type
In-line valve M5			
	2x3/2-way valve		
	Normally closed, external pilot air supply, reset method: pneumatic spring	573805	VUWG-L10-T32C-A-M5
	Normally open, external pilot air supply, reset method: pneumatic spring	573806	VUWG-L10-T32U-A-M5
	1x normally open, 1x normally closed, external pilot air supply, reset method: pneumatic spring	573807	VUWG-L10-T32H-A-M5
	Normally closed, external pilot air supply, reset method: mechanical spring	574251	VUWG-L10-T32C-M-M5
	Normally open, external pilot air supply, reset method: mechanical spring	574252	VUWG-L10-T32U-M-M5
	1x normally open, 1x normally closed, external pilot air supply, reset method: mechanical spring	574253	VUWG-L10-T32H-M-M5
	5/2-way valve, monostable		
	External pilot air supply, reset method: pneumatic/mechanical spring	573808	VUWG-L10-M52-R-M5
	External pilot air supply, reset method: mechanical spring	574254	VUWG-L10-M52-M-M5
	5/2-way valve, bistable		
	External pilot air supply	573809	VUWG-L10-B52-M5
	5/3-way valve		
	Mid-position closed, external pilot air supply	573810	VUWG-L10-P53C-M5
	Mid-position exhausted, external pilot air supply	573811	VUWG-L10-P53E-M5
Mid-position pressurised, external pilot air supply	573812	VUWG-L10-P53U-M5	

Pneumatic valves VUWG-L10 and VUWG-S10, in-line valves M7

Technical data

Function

2x3/2C, 2x3/2U, 2x3/2H
 5/2-way, single pilot
 5/2-way, double pilot
 5/3C, 5/3U, 5/3E

-  - Width 10 mm

-  - Flow rate
 140 ... 380 l/min



General technical data											
Valve function	T32-A			T32-M			M52-R	B52	M52-M	P53	
Normal position	C ¹⁾	U ²⁾	H ⁴⁾	C ¹⁾	U ²⁾	H ⁴⁾	-	-	-	C ¹⁾	U ²⁾ E ³⁾
Pneumatic spring reset method	Yes			No			Yes ⁵⁾	-	No	No	
Mechanical spring reset method	No			Yes			Yes ⁵⁾	-	Yes	Yes	
Vacuum operation at port 1	No			Yes			No	Yes			
Vacuum operation at port 3/5	Yes										
Design	Piston spool valve										
Sealing principle	Soft										
Actuation type	Pneumatic										
Type of control	Direct										
Pilot air supply	External										
Exhaust function	With flow control										
Type of mounting	Optionally via through-holes ⁷⁾ or on manifold rail										
Mounting position	Any										
Standard nominal flow rate	[l/min] 190			150		140	380		320		
Switching time on/off	[ms] 4/9			6/7		6/12		-	7/16		8/25
Changeover time	[ms] -							5	-		11
Width	[mm] 10										
Port	1, 2, 3, 4, 5			M7							
	12, 14			M5							
Product weight	[g] 48			51		45		48		41 48	
Corrosion resistance class CRC ⁶⁾	2										

- 1) C = Normally closed
- 2) U=Normally open/mid-position pressurised
- 3) E = Normally exhausted
- 4) H=2x 3/2-way valve in one housing with 1x normally closed and 1x normally open
- 5) Combined reset method
- 6) Corrosion resistance class 2 according to Festo standard 940 070
 Components subject to moderate corrosion stress. Externally visible parts with primarily decorative surface requirements which are in direct contact with a normal industrial environment or media such as coolants or lubricating agents.
- 7) If several valves are to be screwed together via the through-holes to form a block, a minimum gap of 0.3 mm must be ensured by placing spacer discs between them.

Pneumatic valves VUWG-L10 and VUWG-S10, in-line valves M7

Technical data

Operating and environmental conditions						
Valve function	T32-A ²⁾	T32-M ³⁾	M52-R ⁴⁾	B52	M52-M ³⁾	P53
Operating medium	Compressed air to ISO 8573-1:2010 [7:4:4]					
Note on operating/pilot medium	Lubricated operation possible (required during subsequent operation)					
Operating pressure [bar]	1.5 ... 10	-0.9...10	2.5 ... 10	-0.9...10	-0.9...8	-0.9...10
Pilot pressure ¹⁾ [bar]	1.5...10	2 ... 10	2.5 ... 10	1.5 ... 10	3 ... 10	
Ambient temperature [°C]	-5 ... +60					
Temperature of medium [°C]	-5 ... +50					

- 1) Note operating pressure/pilot pressure graph → page 4
- 2) Pneumatic spring
- 3) Mechanical spring
- 4) Mixed, pneumatic/mechanical spring

Information on materials	
Housing	Wrought aluminium alloy
Seals	HNBR, NBR
Note on materials	RoHS-compliant

Dimensions Download CAD data → www.festo.com

2x3/2-way, 5/2-way and 5/3-way valve

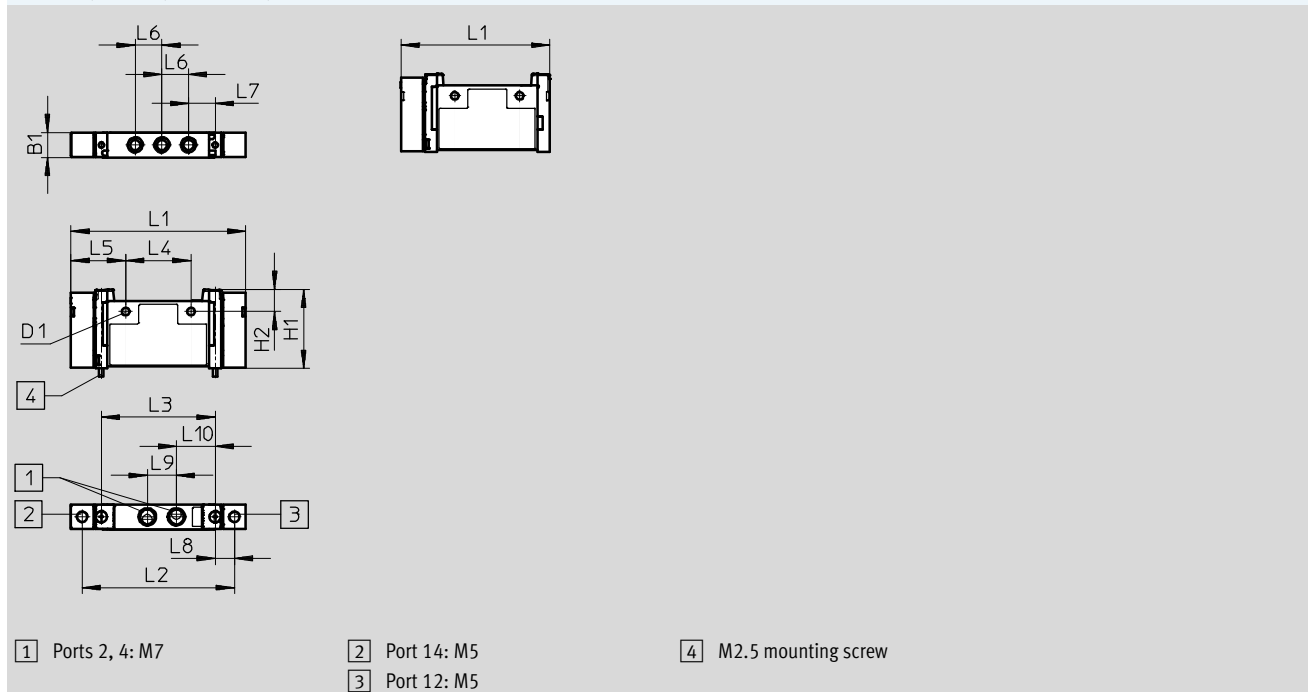

Type	B1	D1	H1	H2	L1	L2	L3	L4	L5	L6	L7	L8	L9	L10
VUWG-L10-...	10.2	3.2	32.5	9.1	72	62.8	47	27	22.5	11	11	7.9	12	16
VUWG-L10-M52-...					62									

Pneumatic valves VUWG-L10 and VUWG-S10, in-line valves M7

Technical data

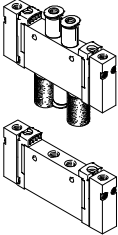
Ordering data			
	Description	Part No.	Type
In-line valve M7			
	2x3/2-way valve		
	Normally closed, external pilot air supply, reset method: pneumatic spring	573821	VUWG-L10-T32C-A-M7
	Normally open, external pilot air supply, reset method: pneumatic spring	573822	VUWG-L10-T32U-A-M7
	1x normally open, 1x normally closed, external pilot air supply, reset method: pneumatic spring	573823	VUWG-L10-T32H-A-M7
	Normally closed, external pilot air supply, reset method: mechanical spring	574255	VUWG-L10-T32C-M-M7
	Normally open, external pilot air supply, reset method: mechanical spring	574256	VUWG-L10-T32U-M-M7
	1x normally open, 1x normally closed, external pilot air supply, reset method: mechanical spring	574257	VUWG-L10-T32H-M-M7
	5/2-way valve, monostable		
	External pilot air supply, reset method: pneumatic/mechanical spring	573824	VUWG-L10-M52-R-M7
	External pilot air supply, reset method: mechanical spring	574258	VUWG-L10-M52-M-M7
	5/2-way valve, bistable		
	External pilot air supply	573825	VUWG-L10-B52-M7
	5/3-way valve		
	Mid-position closed, external pilot air supply	573826	VUWG-L10-P53C-M7
	Mid-position exhausted, external pilot air supply	573827	VUWG-L10-P53E-M7
Mid-position pressurised, external pilot air supply	573828	VUWG-L10-P53U-M7	

Pneumatic valves VUWG-L10 and VUWG-S10, in-line valves M5/M7

Order code

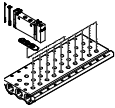
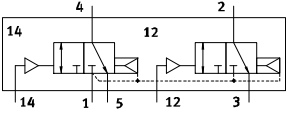
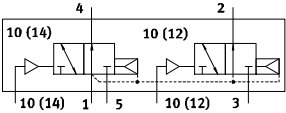
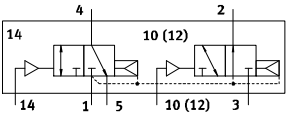
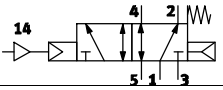
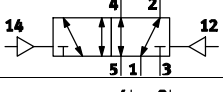
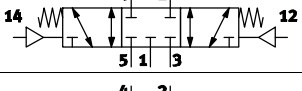
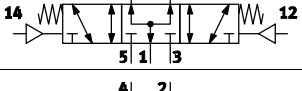
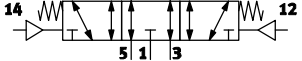
VUWG	-	10	-	-
Valve design				
In-line, individual valve		L		
				
In-line valve, manifold valve incl. seal and screws		S		
				
Width				
10 mm		10		
Valve functions				
				T32C
				T32U
				T32H
				M52
				B52
				P53C
				P53U
				P53E

- 1) If Q... is chosen for the pneumatic connection, this also applies to the exhaust ports 3 and 5
- 2) Flow rate applies to 5/2-way individual valve

		Exhausting with VUWG-L
QN	QS if QS ¹⁾	
U	Silencer	
-	M5 and M7	
Pneumatic connection		Flow rate [(l/min)²]
M5	Thread M5	220
Q3	Push-in connector 3 mm/M5	100
Q4	Push-in connector 4 mm/M5	200
Q6	Push-in connector 6 mm/M5	220
T14	Push-in connector 1/4"	220
T18	Push-in connector 3/8"	100
T316	Push-in connector 3/16"	200
T532	Push-in connector 5/32"	200
M7	Thread M7	380
Q4H	Push-in connector 4 mm/M7	220
Q6H	Push-in connector 6 mm/M7	330
T14H	Push-in connector 1/4", M7	330
T316H	Push-in connector 3/16", M7	200
Reset method		
A	Pneumatic spring for T32 and M52	
M	Mechanical spring for T32 and M52	
R	Pneu./mech. spring for M52	
-	With B52 and P53	

Pneumatic valves VUWG-S10, in-line valves M5/M7

Manifold assembly

In-line valves for manifold assembly



Dimensions

Download CAD data → www.festo.com

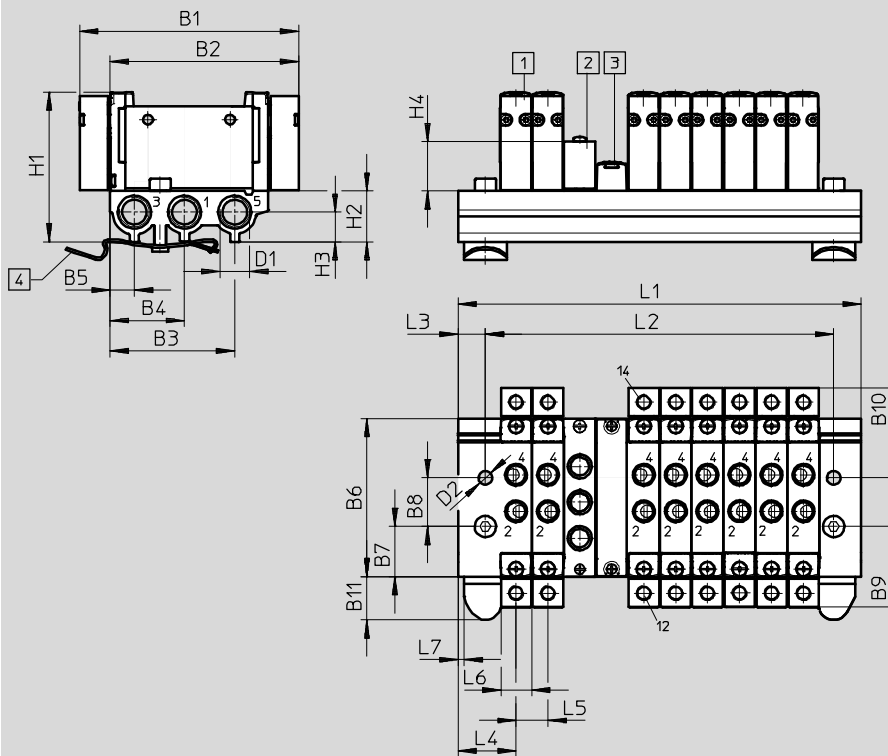

- 1 Pneumatic valve
- 2 Supply plate M5 or M7 for 1, 3, 5
- 3 Blanking plate VABB-L1-10-S
- 4 H-rail mounting (two M4x20 screws to DIN 912 are required)

Type	B1	B2	B3	B4	B5	B6	B7	B8	B9	B10	B11
VABM-L1-10S-G18	72	62	41	24.5	8	52	16.5	16	26.5	29.5	14.45

Type	D1	D2	H1	H2	H3	H4	H4	L3	L4	L5	L6	L7
VABM-L1-10S-G18	G $\frac{1}{8}$	4.5	49.3	16.8	7	16.2	16.2	9	19	10.5	10.3	2

Valve positions	2	3	4	5	6	7	8	9	10	12	14	16	22
L1 [mm]	48.5	59	69.5	80	90.5	101	111.5	122	132.5	153.5	174.5	195.5	258.5
L2 [mm]	30.5	41	51.5	62	72.5	83	93.5	104	114.5	135.5	156.5	177.5	240.5

Pneumatic valves VUWG-S10, in-line valves M5/M7

Ordering data

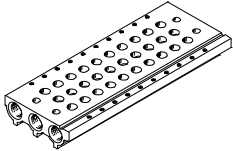
Technical data – Manifold rails							
	Port	CRC	Material ²⁾	Operating pressure [bar]	Max. tightening torque for assembly [Nm]		
	1, 3, 5				Valve	H-rail	Wall
	G $\frac{1}{8}$	2 ¹⁾	Wrought aluminium alloy	-0.9 ... 10	0.45	1.5	3

- 1) Corrosion resistance class 2 according to Festo standard 940 070
Components subject to moderate corrosion stress. Externally visible parts with primarily decorative surface requirements which are in direct contact with a normal industrial environment or media such as coolants or lubricating agents.
- 2) Note on materials: RoHS-compliant.



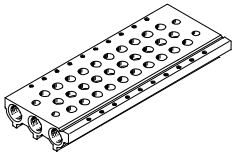

Order code – Manifold rails

VABM	-	L1	-	10	S	-	G18	-	
Manifold assembly parts									Number of valve positions
Manifold rail		VABM							2 to 10, 12, 14 and 16
Valve series									Ports 1, 3, 5
VUWG		L1					G18	G $\frac{1}{8}$	
Valve width									
10 mm				10					
Manifold rail with ports 1, 3, 5									
For M5 and M7 in-line valves					S				

Ordering data – Manifold rail			
	Description	Part No.	Type
	For valve size M5/M7	2 valve positions	566558 VABM-L1-10S-G18-2
		3 valve positions	566559 VABM-L1-10S-G18-3
		4 valve positions	566560 VABM-L1-10S-G18-4
		5 valve positions	566561 VABM-L1-10S-G18-5
		6 valve positions	566562 VABM-L1-10S-G18-6
		7 valve positions	566563 VABM-L1-10S-G18-7
		8 valve positions	566564 VABM-L1-10S-G18-8
		9 valve positions	566565 VABM-L1-10S-G18-9
		10 valve positions	566566 VABM-L1-10S-G18-10
		12 valve positions	566567 VABM-L1-10S-G18-12
		14 valve positions	566568 VABM-L1-10S-G18-14
		16 valve positions	566569 VABM-L1-10S-G18-16

Pneumatic valves VUWG-S10, in-line valves M5/M7

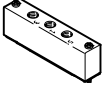
Ordering data

Ordering data – Accessories				
	Description		Part No.	Type
Blanking plate Technical data → Internet: vabb				
	For manifold rail for M5/M7 in-line valves	Incl. screws and seal	566462	VABB-L1-10-S
Separator Technical data → Internet: vabd				
	For manifold rail for M5/M7 in-line valves	Separator for pressure zones	569995	VABD-8-B
Supply plate Technical data → Internet: vabf				
	For manifold rail for M5 in-line valves	Incl. screws and seal	569991	VABF-L1-10-P3A4-M5
	For manifold rail for M7 in-line valves		569992	VABF-L1-10-P3A4-M7
Seals for in-line valves Technical data → Internet: vabd				
	M5	Delivery unit: 10 sets (each with 2 screws and 1 seal)	566672	VABD-L1-10X-S-M5
	M7		566673	VABD-L1-10X-S-M7

Pneumatic valves VUWG-L14 and VUWG-S14, in-line valves G¹/₈

FESTO

Technical data

Function
2x3/2C, 2x3/2U, 2x3/2H
5/2-way, single pilot
5/2-way, double pilot
5/3C, 5/3U, 5/3E

-  - Width 14 mm

-  - Flow rate
500 ... 780 l/min



General technical data												
Valve function	T32-A			T32-M			M52-A	B52	M52-M	P53		
Normal position	C ¹⁾	U ²⁾	H ⁴⁾	C ¹⁾	U ²⁾	H ⁴⁾	-	-	-	C ¹⁾	U ²⁾	E ³⁾
Pneumatic spring reset method	Yes			No			Yes	-	No	No		
Mechanical spring reset method	No			Yes			No	-	Yes	Yes		
Vacuum operation at port 1	No			Yes			No	Yes				
Vacuum operation at port 3/5	Yes											
Design	Piston spool valve											
Sealing principle	Soft											
Actuation type	Pneumatic											
Type of control	Direct											
Pilot air supply	External											
Exhaust function	With flow control											
Type of mounting	Optionally via through-holes ⁶⁾ or on manifold rail											
Mounting position	Any											
Standard nominal flow rate [l/min]	650	600	650	550	500	780			650	600		
Switching time on/off [ms]	6/19			9/13			12/22	-	12/32	8/30		
Changeover time [ms]	-							6	-	16		
Width [mm]	14											
Port	1, 2, 3, 4, 5			G ¹ / ₈								
	12, 14			M5								
Product weight [g]	81			77			75	81	67	81		
Corrosion resistance class CRC ⁵⁾	2											

1) C = Normally closed

2) U = Normally open/mid-position pressurised

3) E = Normally exhausted

4) H = 2x3/2-way valve in one housing with 1x normally closed and 1x normally open

5) Corrosion resistance class 2 according to Festo standard 940 070

Components subject to moderate corrosion stress. Externally visible parts with primarily decorative surface requirements which are in direct contact with a normal industrial environment or media such as coolants or lubricating agents.

6) If several valves are to be screwed together via the through-holes to form a block, a minimum gap of 0.3 mm must be ensured by placing spacer discs between them.

Pneumatic valves VUWG-L14 and VUWG-S14, in-line valves G¹/₈

Technical data

Operating and environmental conditions						
Valve function		T32-A ²⁾	T32-M ³⁾	M52-A ²⁾	B52	M52-M ³⁾ P53
Operating medium	Compressed air to ISO 8573-1:2010 [7:4:4]					
Note on operating/pilot medium	Lubricated operation possible (required during subsequent operation)					
Operating pressure	[bar]	1.5 ... 10	-0.9 ... 10	2.5 ... 10	-0.9 ... 10	-0.9 ... 10
Pilot pressure ¹⁾	[bar]	1.5 ... 10	2 ... 10	2.5 ... 10	1.5 ... 10	3 ... 10
Ambient temperature	[°C]	-5 ... +60				
Temperature of medium	[°C]	-5 ... +50				

1) Note operating pressure/pilot pressure graph → page 4

2) Pneumatic spring

3) Mechanical spring

Information on materials	
Housing	Wrought aluminium alloy
Seals	HNBR, NBR
Note on materials	RoHS-compliant

Dimensions Download CAD data → www.festo.com

2x3/2-way, 5/2-way and 5/3-way valve

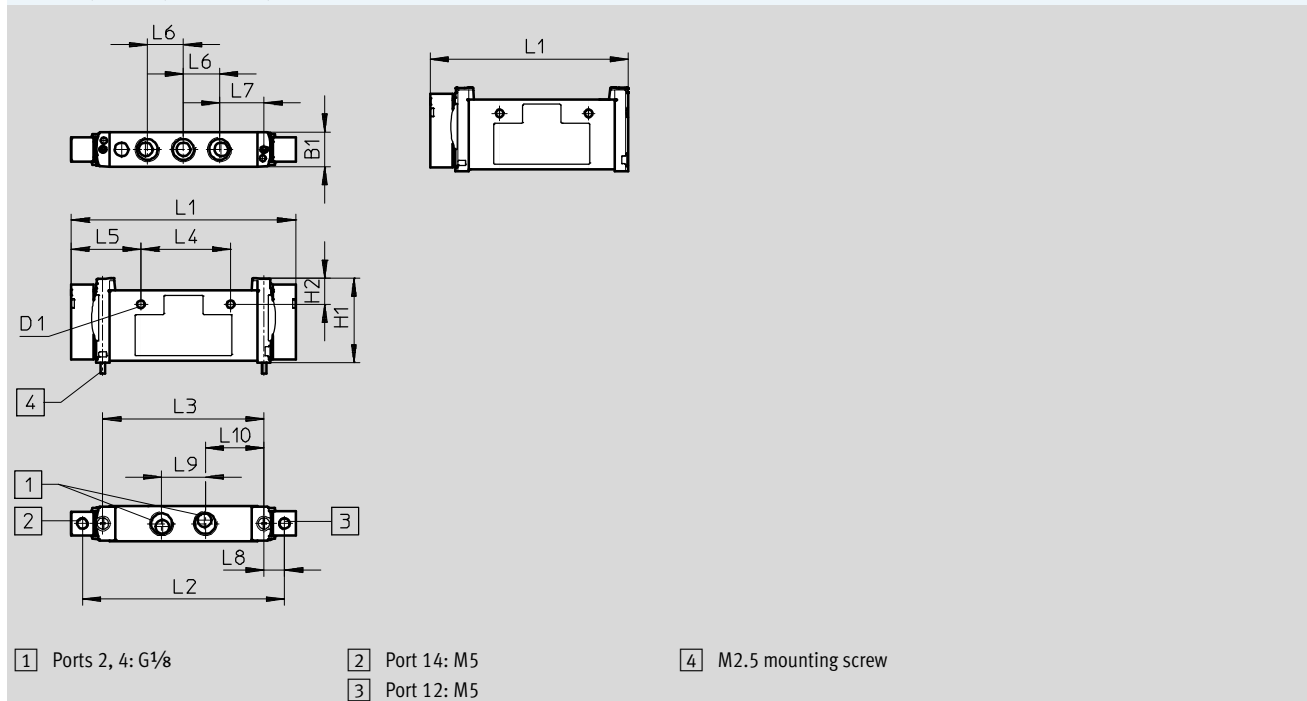

Type	B1	D1	H1	H2	L1	L2	L3	L4	L5	L6	L7	L8	L9	L10
VUWG-L14-...	14.4	3.2	34.8	10.8	92.6	83.4	66.5	37	28.8	14.9	18.35	8.45	18	24.25
VUWG-L14-M52-...					82.25									

Pneumatic valves VUWG-L14 and VUWG-S14, in-line valves G¹/₈

FESTO

Technical data

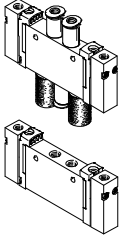
Ordering data		Part No.	Type
In-line valve G ¹ / ₈			
	2x3/2-way valve		
	Normally closed, external pilot air supply, reset method: pneumatic spring	573829	VUWG-L14-T32C-A-G18
	Normally open, external pilot air supply, reset method: pneumatic spring	573830	VUWG-L14-T32U-A-G18
	1x normally open, 1x normally closed, external pilot air supply, reset method: pneumatic spring	573831	VUWG-L14-T32H-A-G18
	Normally closed, external pilot air supply, reset method: mechanical spring	574259	VUWG-L14-T32C-M-G18
	Normally open, external pilot air supply, reset method: mechanical spring	574260	VUWG-L14-T32U-M-G18
	1x normally open, 1x normally closed, external pilot air supply, reset method: mechanical spring	574261	VUWG-L14-T32H-M-G18
	5/2-way valve, monostable		
	External pilot air supply, reset method: pneumatic/mechanical spring	573832	VUWG-L14-M52-A-G18
	External pilot air supply, reset method: mechanical spring	574262	VUWG-L14-M52-M-G18
	5/2-way valve, bistable		
	External pilot air supply	573833	VUWG-L14-B52-G18
	5/3-way valve		
	Mid-position closed, external pilot air supply	573834	VUWG-L14-P53C-G18
	Mid-position exhausted, external pilot air supply	573835	VUWG-L14-P53E-G18
Mid-position pressurised, external pilot air supply	573836	VUWG-L14-P53U-G18	

Pneumatic valves VUWG-L14 and VUWG-S14, in-line valves G1/8

Order code

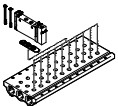
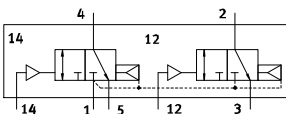
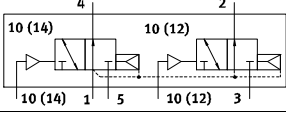
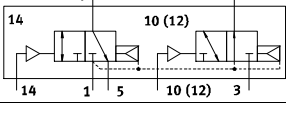
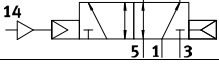
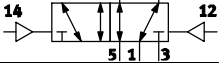
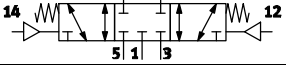
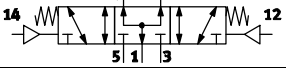
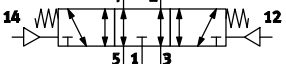
VUWG	-	14	-	
Valve design				
In-line, individual valve		L		
				
In-line valve, manifold valve incl. seal and screws		S		
				
Width				
14 mm		14		
Valve functions				
				T32C
				T32U
				T32H
				M52
				B52
				P53C
				P53U
				P53E

- 1) If Q... is chosen for the pneumatic connection, this also applies to the exhaust ports 3 and 5
- 2) Flow rate applies to 5/2-way individual valve

		Exhausting with VUWG-L	
QN		QS if QS ¹⁾	
U		Silencer	
-		G1/8	
Pneumatic connection		Flow rate [l/min]²⁾	
G18	Thread G1/8		780
Q4	Push-in connector 4 mm/G1/8		200
Q6	Push-in connector 6 mm/G1/8		400
Q8	Push-in connector 8 mm/G1/8		700
T14	Push-in connector 1/4"		400
T516	Push-in connector 5/16"		700
Reset method			
A	Pneumatic spring for T32 and M52		
M	Mechanical spring for T32 and M52		
-	With B52 and P53		

Pneumatic valves VUWG-S14, in-line valves G1/8

Manifold assembly



In-line valves for manifold assembly



Dimensions

Download CAD data → www.festo.com

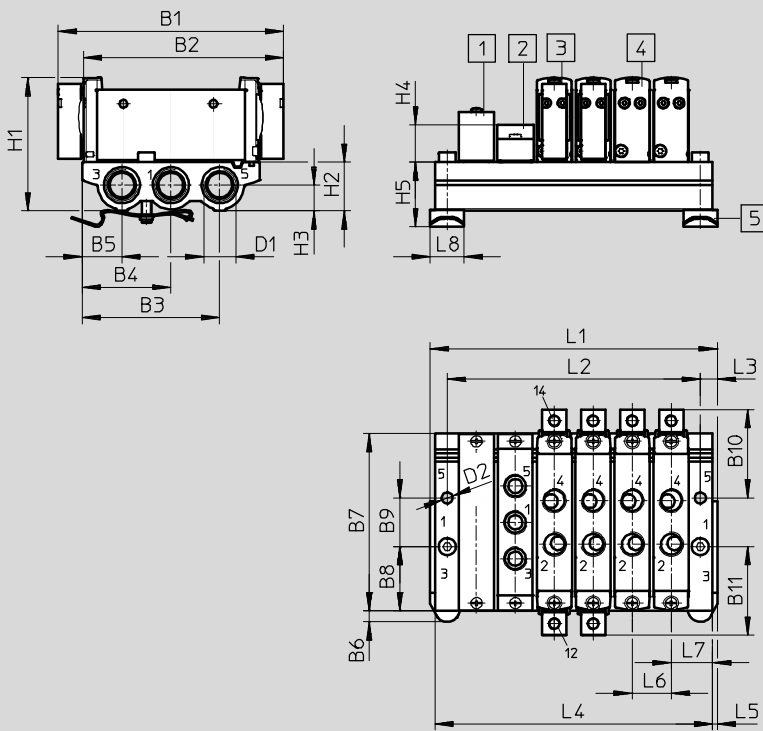

- 1 Blanking plate
VABB-L1-14
- 2 Supply plate
VABF-L1-14-P3A4-G18
- 3 Double pilot pneumatic valve
- 4 Single pilot pneumatic valve
- 5 H-rail mounting
(two M4x25 screws to DIN 912 are required for mounting)

Type	B1	B2	B3	B4	B5	B6	B7	B8	B9	B10	B11	D1
VABM-L1-14S-G14	92.6	82.3	56.6	36.5	16.4	4.5	72.9	26.45	20	36.3	36.3	G1/4

Type	D2	H1	H2	H3	H4	H5	L3	L5	L6	L7
VABM-L1-14S-G14	Ø 4.5	54.8	20	10.6	15.4	26.4	7	2	16	17

Valve positions	2	3	4	5	6	7	8	9	10	12	14	16
L1 [mm]	54	70	86	98	118	134	150	166	182	214	246	278
L2 [mm]	40	56	72	88	104	120	136	152	168	200	232	264
L4 [mm]	50	66	82	98	114	130	146	162	178	210	242	274

Pneumatic valves VUWG-S14, in-line valves G1/8

Ordering data

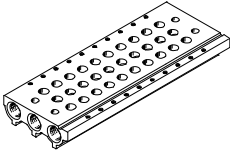
Technical data – Manifold rails							
	Port	CRC	Material ²⁾	Operating pressure [bar]	Max. tightening torque for assembly [Nm]		
	1, 3, 5				Valve	H-rail	Wall
	G1/4	2 ¹⁾	Wrought aluminium alloy	-0.9 ... 10	0.65	1.5	3

- 1) Corrosion resistance class 2 according to Festo standard 940 070
Components subject to moderate corrosion stress. Externally visible parts with primarily decorative surface requirements which are in direct contact with a normal industrial environment or media such as coolants or lubricating agents.
- 2) Note on materials: RoHS-compliant.

Order code – Manifold rails

VABM	-	L1	-	14	S	-	G14	-	
Manifold assembly parts									Number of valve positions
Manifold rail		VABM							2 to 10, 12, 14 and 16
Valve series									Ports 1, 3, 5
VUWG		L1					G14	G1/4	
Valve width									
14 mm				14					
Manifold rail with ports 1, 3, 5									
For G1/8 in-line valves					S				



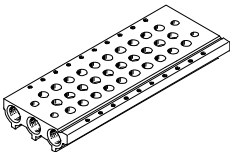

Ordering data – Manifold rail

	Description	Part No.	Type
Manifold rail for in-line valves (manifold assembly)			
	For valve size G1/8		
	2 valve positions	566618	VABM-L1-14S-G14-2
	3 valve positions	566619	VABM-L1-14S-G14-3
	4 valve positions	566620	VABM-L1-14S-G14-4
	5 valve positions	566621	VABM-L1-14S-G14-5
	6 valve positions	566622	VABM-L1-14S-G14-6
	7 valve positions	566623	VABM-L1-14S-G14-7
	8 valve positions	566624	VABM-L1-14S-G14-8
	9 valve positions	566625	VABM-L1-14S-G14-9
	10 valve positions	566626	VABM-L1-14S-G14-10
12 valve positions	566627	VABM-L1-14S-G14-12	
14 valve positions	566628	VABM-L1-14S-G14-14	
16 valve positions	566629	VABM-L1-14S-G14-16	

Pneumatic valves VUWG-S14, in-line valves G1/8

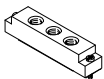

Ordering data

Ordering data – Accessories			
	Description	Part No.	Type
Blanking plate Technical data → Internet: vabb			
	For manifold rail for G1/8 in-line valves	Incl. screws and seal	569989 VABB-L1-14
Separator Technical data → Internet: vabd			
	For manifold rail for G1/8 in-line valves	Separator for pressure zones	569996 VABD-10-B
Supply plate Technical data → Internet: vabf			
	For manifold rail for G1/8 in-line valves	Incl. screws and seal	569993 VABF-L1-14-P3A4-G18
Seals for in-line valves Technical data → Internet: vabd			
	G1/8	Delivery unit: 10 sets (each with 2 screws and 1 seal)	566675 VABD-L1-14X-S-G18

Pneumatic valves VUWG-L18 and VUWG-S18, in-line valves G¹/₄

Technical data

Function

2x3/2C, 2x3/2U, 2x3/2H

5/2-way, single pilot

5/2-way, double pilot

5/3C, 5/3U, 5/3E

 - Width 18 mm

 - Flow rate
1,000 ... 1,380 l/min

General technical data												
Valve function	T32-A			T32-M			M52-R	B52	M52-M	P53		
Normal position	C ¹⁾	U ²⁾	H ⁴⁾	C ¹⁾	U ²⁾	H ⁴⁾	–	–	–	C ¹⁾	U ²⁾	E ³⁾
Pneumatic spring reset method	Yes			No			Yes ⁵⁾	–	No	No		
Mechanical spring reset method	No			Yes			Yes ⁵⁾	–	Yes	Yes		
Vacuum operation at port 1	No			Yes			No	Yes				
Vacuum operation at port 3/5	Yes											
Design	Piston spool valve											
Sealing principle	Soft											
Actuation type	Pneumatic											
Type of control	Direct											
Pilot air supply	External											
Exhaust function	With flow control											
Type of mounting	Optionally via through-holes ⁷⁾ or on manifold rail											
Mounting position	Any											
Standard nominal flow rate	[l/min]	1,000					1,300	1,380	1,300	1,200		
Switching time on/off	[ms]	12/36			17/25			16/40	–	12/59	17/69	
Changeover time	[ms]	–										
Width	[mm]	18										
Port	1, 2, 3, 4, 5 12, 14	G ¹ / ₄ M5										
Product weight	[g]	160					152	160	152			
Corrosion resistance class CRC ⁶⁾	2											

1) C = Normally closed

2) U = Normally open/mid-position pressurised

3) E = Normally exhausted

4) H = 2x 3/2-way valve in one housing with 1x normally closed and 1x normally open

5) Combined reset method

6) Corrosion resistance class 2 according to Festo standard 940 070

Components subject to moderate corrosion stress. Externally visible parts with primarily decorative surface requirements which are in direct contact with a normal industrial environment or media such as coolants or lubricating agents.

7) If several valves are to be screwed together via the through-holes to form a block, a minimum gap of 0.3 mm must be ensured by placing spacer discs between them.

Pneumatic valves VUWG-L18 and VUWG-S18, in-line valves G^{1/4}

Technical data

Operating and environmental conditions						
Valve function		T32-A ²⁾	T32-M ³⁾	M52-R ⁴⁾	B52	M52-M ³⁾ P53
Operating medium	Compressed air to ISO 8573-1:2010 [7:4:4]					
Note on operating/pilot medium	Lubricated operation possible (required during subsequent operation)					
Operating pressure	[bar]	1.5 ... 10	-0.9 ... 10	2.5 ... 10	-0.9 ... 10	-0.9 ... 10
Pilot pressure ¹⁾	[bar]	1.5 ... 10	2 ... 10	2.5 ... 10	1.5 ... 10	3 ... 10
Ambient temperature	[°C]	-5 ... +60				
Temperature of medium	[°C]	-5 ... +50				

- 1) Note operating pressure/pilot pressure graph → page 4
- 2) Pneumatic spring
- 3) Mechanical spring
- 4) Mixed, pneumatic/mechanical spring

Information on materials	
Housing	Wrought aluminium alloy
Seals	HNBR, NBR
Note on materials	RoHS-compliant

Dimensions Download CAD data → www.festo.com

2x3/2-way, 5/2-way and 5/3-way valve

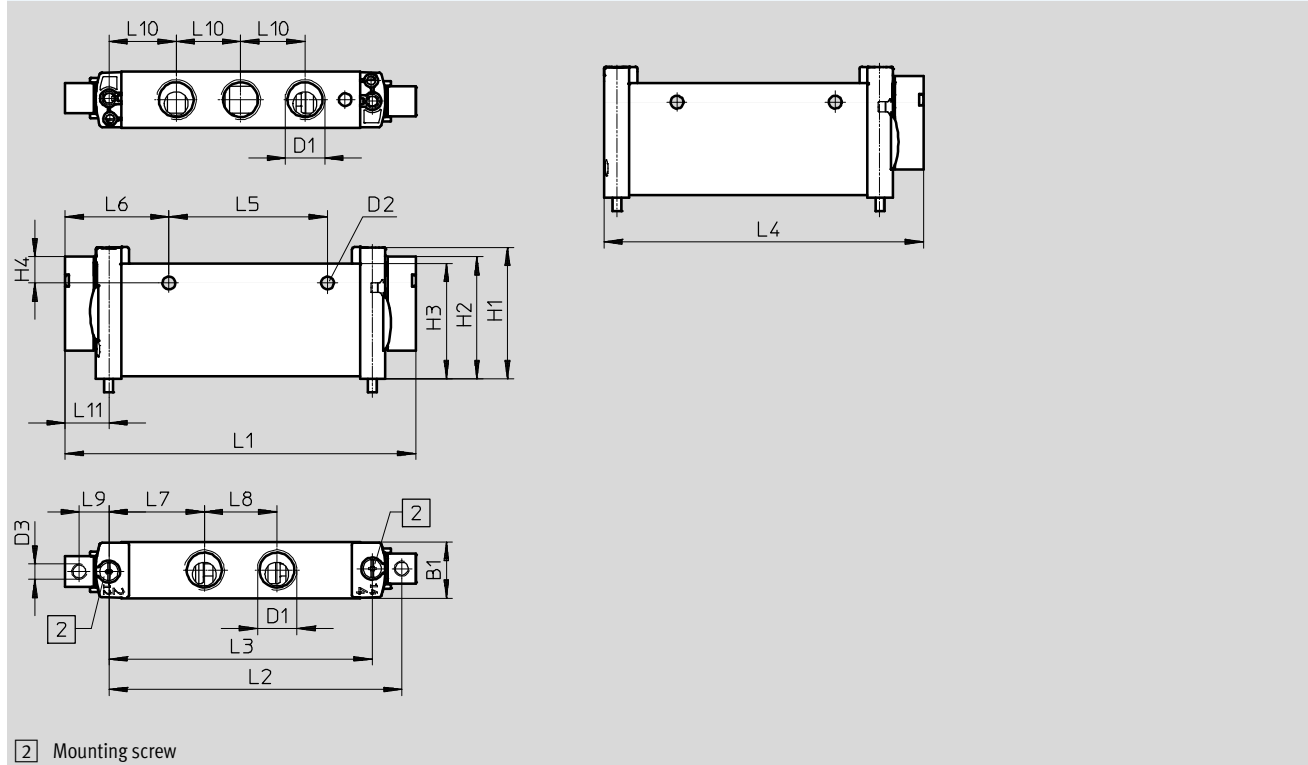

Type	B1	D1	D2	D3	H1	H2	H3	H4	L1	L2	L3	L4	L5	L6	L7	L8	L9	L10	L11
VUWG-L18-...	18.3	D ^{1/4}	4.2	M5	43.1	40	37.8	6.4	115	96.1	86.4	105	52	34	31.3	23.8	9.7	21.1	14.3

Pneumatic valves VUWG-L18 and VUWG-S18, in-line valves G¹/₄

Technical data

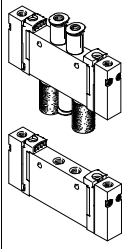
Ordering data			
	Description	Part No.	Type
In-line valve G ¹ / ₄			
	2x3/2-way valve		
	Normally closed, external pilot air supply, reset method: pneumatic spring	574263	VUWG-L18-T32C-A-G14
	Normally open, external pilot air supply, reset method: pneumatic spring	574264	VUWG-L18-T32U-A-G14
	1x normally open, 1x normally closed, external pilot air supply, reset method: pneumatic spring	574265	VUWG-L18-T32H-A-G14
	Normally closed, external pilot air supply, reset method: mechanical spring	574266	VUWG-L18-T32C-M-G14
	Normally open, external pilot air supply, reset method: mechanical spring	574267	VUWG-L18-T32U-M-G14
	1x normally open, 1x normally closed, external pilot air supply, reset method: mechanical spring	574268	VUWG-L18-T32H-M-G14
	5/2-way valve, monostable		
	External pilot air supply, reset method: pneumatic/mechanical spring	574269	VUWG-L18-M52-R-G14
	External pilot air supply, reset method: mechanical spring	574270	VUWG-L18-M52-M-G14
	5/2-way valve, bistable		
	External pilot air supply	574271	VUWG-L18-B52-G14
	5/3-way valve		
	Mid-position closed, external pilot air supply	574272	VUWG-L18-P53C-G14
Mid-position exhausted, external pilot air supply	574273	VUWG-L18-P53E-G14	
Mid-position pressurised, external pilot air supply	574274	VUWG-L18-P53U-G14	

Pneumatic valves VUWG-L18 and VUWG-S18, in-line valves G¹/₄

Order code

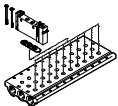
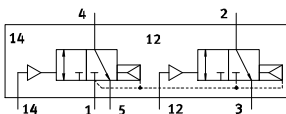
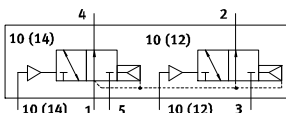
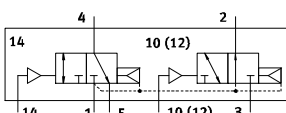
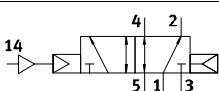
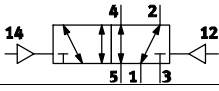
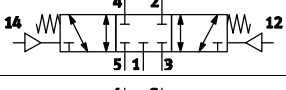
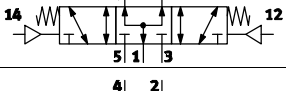
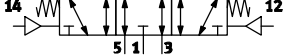
VUWG	-	18	-	
Valve design				
In-line, individual valve		L		
				
In-line valve, manifold valve incl. seal and screws		S		
				
Width				
18 mm		18		
Valve functions				
				T32C
				T32U
				T32H
				M52
				B52
				P53C
				P53U
				P53E

- 1) If Q... is chosen for the pneumatic connection, this also applies to the exhaust ports 3 and 5
- 2) Flow rate applies to 5/2-way individual valve

		Exhausting with VUWG-L	
QN		QS	if QS ¹⁾
U		Silencer	
-		G ¹ / ₈	
Pneumatic connection		Flow rate [l/min]²⁾	
G14	Thread G ¹ / ₄	1,300	
Q6	Push-in connector 6 mm	400	
Q8	Push-in connector 8 mm	700	
Q10	Push-in connector 10 mm	1,100	
T14	Push-in connector ¼"	400	
T38	Push-in connector ⅜"	1,200	
T516	Push-in connector ⅝"	700	
Reset method			
A	Pneumatic spring for T32 and M52		
M	Mechanical spring for T32 and M52		
R	Pneu./mech. spring for M52		
-	With B52 and P53		

Pneumatic valves VUWG-S18, in-line valves G1/4

Manifold assembly

In-line valves for manifold assembly



Dimensions

Download CAD data → www.festo.com

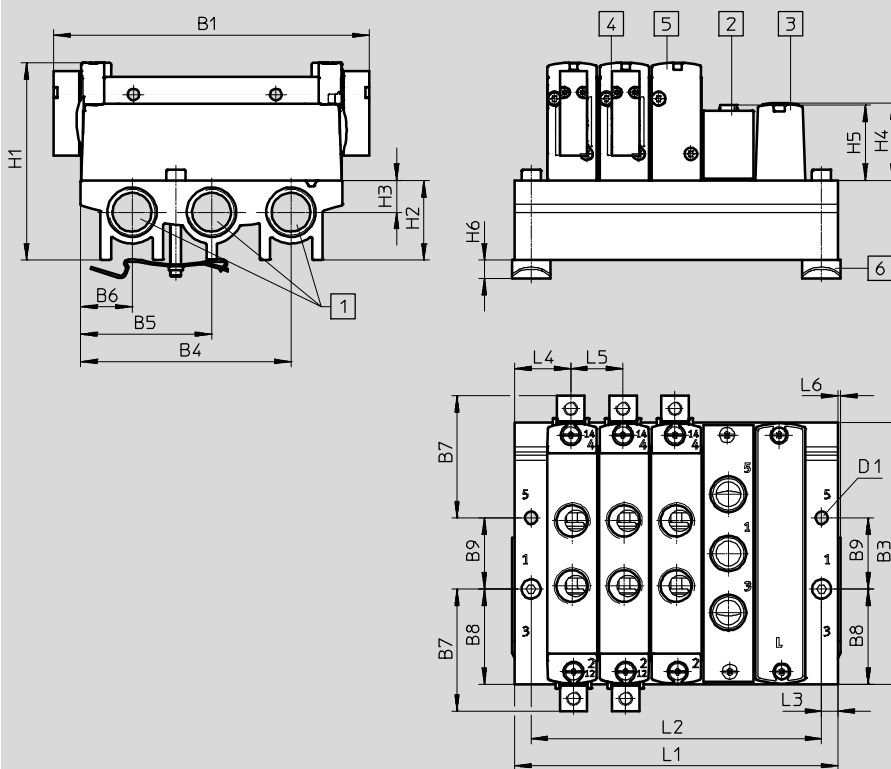

- 1 Ports 1, 3 and 5: G3/8
- 2 Blanking plate VABB-L1-18
- 3 Supply plate VABF-L1-18-P3A4-G14
- 4 Double pilot pneumatic valve
- 5 Single pilot pneumatic valve
- 6 H-rail mounting (two M4x35 screws to DIN 912 are required)

Type	B1	B3	B4	B5	B6	B7	B8	B9	D1	H1	H2
VABM-L1-18S-G38	115	95.6	76.8	47.8	18.8	44.5	34.8	26	4.5	72.1	29

Type	H3	H4	H5	H6	L3	L4	L5	L6
VABM-L1-18S-G38	11.5	28.4	27.6	6.5	6	20.5	19	1

Valve positions	2	3	4	5	6	7	8	9	10	12	14	16
L1 [mm]	61	80	99	118	137	156	175	194	213	251	289	327
L2 [mm]	49	68	87	106	125	144	163	182	201	239	277	315

Pneumatic valves VUWG-S18, in-line valves G1/4

Ordering data

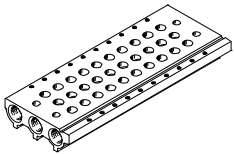
Technical data – Manifold rails							
	Port	CRC	Material ²⁾	Operating pressure [bar]	Max. tightening torque for assembly [Nm]		
	1, 3, 5				Valve	H-rail	Wall
	G3/8	2 ¹⁾	Wrought aluminium alloy	-0.9 ... 10	0.65	1.5	3

- 1) Corrosion resistance class 2 according to Festo standard 940 070
Components subject to moderate corrosion stress. Externally visible parts with primarily decorative surface requirements which are in direct contact with a normal industrial environment or media such as coolants or lubricating agents.
- 2) Note on materials: RoHS-compliant.



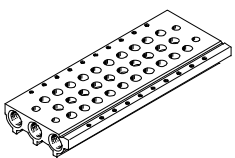

Order code – Manifold rails

VABM	-	L1	-	18	S	-	G38	-	
Manifold assembly parts									Number of valve positions
Manifold rail		VABM							2 to 10, 12, 14 and 16
Valve series									Ports 1, 3, 5
VUWG		L1							G38 G3/8
Valve width									
18 mm				18					
Manifold rail with ports 1, 3, 5									
For G1/8 in-line valves					S				

Ordering data – Manifold rail				
	Description	Part No.	Type	
	For valve size G1/4	2 valve positions	574455	VABM-L1-18S-G38-2
		3 valve positions	574456	VABM-L1-18S-G38-3
		4 valve positions	574457	VABM-L1-18S-G38-4
		5 valve positions	574458	VABM-L1-18S-G38-5
		6 valve positions	574459	VABM-L1-18S-G38-6
		7 valve positions	574460	VABM-L1-18S-G38-7
		8 valve positions	574461	VABM-L1-18S-G38-8
		9 valve positions	574462	VABM-L1-18S-G38-9
		10 valve positions	574463	VABM-L1-18S-G38-10
		12 valve positions	574464	VABM-L1-18S-G38-12
		14 valve positions	574465	VABM-L1-18S-G38-14
		16 valve positions	574466	VABM-L1-18S-G38-16

Pneumatic valves VUWG-S18, in-line valves G1/4

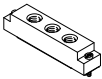
Ordering data

Ordering data – Accessories			
	Description	Part No.	Type
Blanking plate Technical data → Internet: vabb			
	For manifold rail for G1/4 in-line valves	Incl. screws and seal	574482 VABB-L1-18
Separator Technical data → Internet: vabd			
	For manifold rail for G1/4 in-line valves	Separator for pressure zones	574483 VABD-14-B
Supply plate Technical data → Internet: vabf			
	For manifold rail for G1/4 in-line valves	Incl. screws and seal	574481 VABF-L1-18-P3A4-G14
Seals for in-line valves Technical data → Internet: vabd			
	G1/4	Delivery unit: 10 sets (each with 2 screws and 1 seal)	574479 VABD-L1-18X-S-G14

 **Note**

Connect supply plate at port 1 with compressed air. Reverse operation (pressure at port 3/5) is not permissible.

Pneumatic valves VUWG-B10A, sub-base valves

Technical data

Function
 5/2-way, single pilot
 5/2-way, double pilot
 5/3C, 5/3U, 5/3E

-  - Width 10 mm

-  - Flow rate
 80 ... 100 l/min



General technical data						
Valve function	M52-R	B52	M52-M	P53		
Normal position	-	-	-	C ¹⁾	U ²⁾	E ³⁾
Pneumatic spring reset method	Yes ⁴⁾	-	No	No		
Mechanical spring reset method	Yes ⁴⁾	-	Yes	Yes		
Vacuum operation at port 1	No	Yes				
Vacuum operation at port 3/5	Yes					
Design	Piston spool valve					
Sealing principle	Soft					
Actuation type	Pneumatic					
Type of control	Direct					
Pilot air supply	External					
Exhaust function	With flow control					
Type of mounting	On manifold rail					
Mounting position	Any					
Standard nominal flow rate	[l/min]	100		80	90	
Switching time on/off	[ms]	5/11	-	5/16	7/19	
Changeover time	[ms]	-	5	-	9	
Width	[mm]	10				
Port	1, 3, 5	M7 in manifold rail				
	2, 4	M5 in manifold rail				
	12, 14	M5				
Product weight	[g]	37	40	34	40	
Corrosion resistance class CRC ⁵⁾		2				

1) C = Normally closed
 2) U = Normally open/mid-position pressurised
 3) E = Normally exhausted
 4) Combined reset method
 5) Corrosion resistance class 2 according to Festo standard 940 070
 Components subject to moderate corrosion stress. Externally visible parts with primarily decorative surface requirements which are in direct contact with a normal industrial environment or media such as coolants or lubricating agents.

Pneumatic valves VUWG-B10A, sub-base valves

Technical data

Operating and environmental conditions					
Valve function		M52-R ³⁾	B52	M52-M ²⁾	P53
Operating medium		Compressed air to ISO 8573-1:2010 [7:4:4]			
Note on operating/pilot medium		Lubricated operation possible (required during subsequent operation)			
Operating pressure	[bar]	2.5 ... 10	-0.9 ... 10	-0.9 ... 8	-0.9 ... 10
Pilot pressure ¹⁾	[bar]	2.5 ... 10	1.5 ... 10	3 ... 10	
Ambient temperature	[°C]	-5 ... +60			
Temperature of medium	[°C]	-5 ... +50			

1) Note operating pressure/pilot pressure graph → page 4

2) Mechanical spring

3) Mixed, pneumatic/mechanical spring

Information on materials	
Housing	Anodised aluminium
Seals	HNBR, NBR
Note on materials	RoHS-compliant

Dimensions Download CAD data → www.festo.com

5/2-way and 5/3-way valve

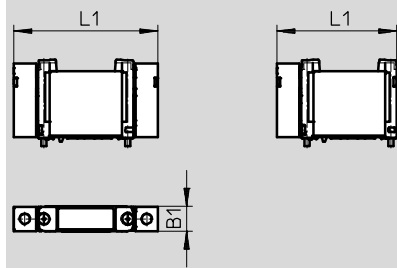

Type	B1	L1
VUWG-B10A-...	10.3	59.9
VUWG-B10A-M52-...		49.9

Pneumatic valves VUWG-B10A, sub-base valves

Order code

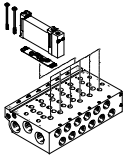
VUWG	-	B	10A	-	-
Valve design					
Sub-base, manifold valve incl. seal and screws		B			
					
Width					
10 mm		10A			

-	F
Pneumatic connection	
F	In the manifold rail
Reset method	
M	Mechanical spring for M52
R	Pneu./mech. spring for M52
-	With B52 and P53

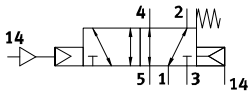
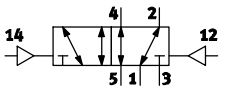
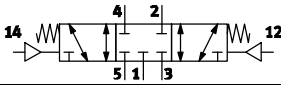
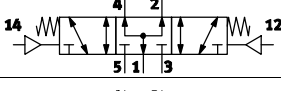
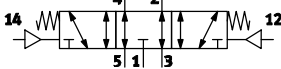
Valve functions	
	M52
	B52
	P53C
	P53U
	P53E

Pneumatic valves VUWG-B10A, sub-base valves

Manifold assembly

Sub-base valve for manifold assembly
M5 connection



Dimensions

Download CAD data → www.festo.com

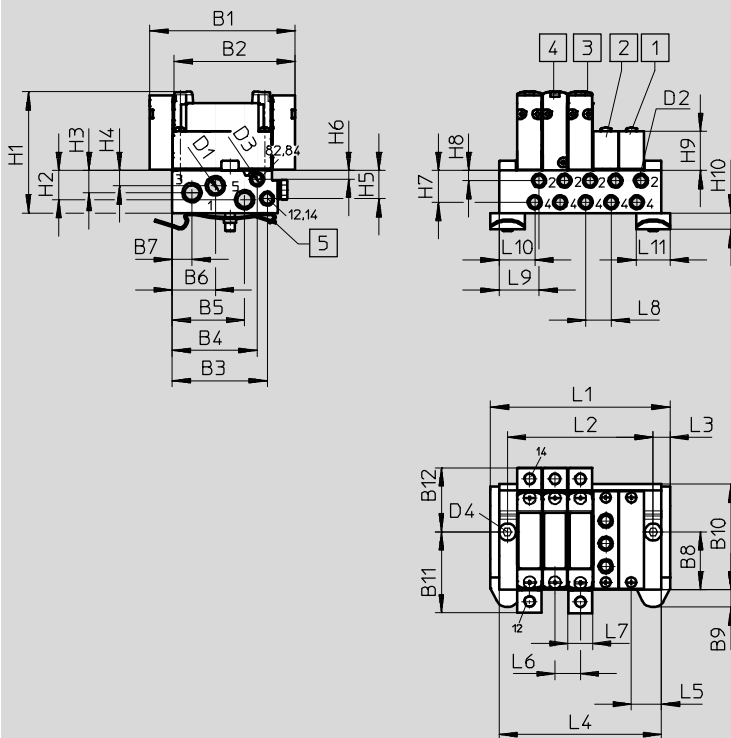

- 1 Blanking plate VABB-L1-10A
- 2 Supply plate VABF-L1-10A-P3A4-M5
- 3 Double pilot pneumatic valve
- 4 Single pilot pneumatic valve
- 5 H-rail mounting (two M4x25 screws to DIN 912 are required)

Type	B1	B2	B3	B4	B5	B6	B7	B8	B9	B10	B11	B12
VABM-L1-10AW-M7	59.9	49.9	39.1	35	29.8	17.8	8.2	24	7.15	43.5	33.45	26.45

Type	H1	H2	H3	H4	H5	H6	H7	H8	H9	H10	D1	D2
VABM-L1-10AW-M7	50	12	9.1	6.3	11.6	3.6	13.1	4.2	16.2	6.8	M7	M5

Type	D3	D4	L3	L5	L6	L7	L8	L9	L10	L11
VABM-L1-10AW-M7	M5	∅4.5	7	12.5	10.5	10.2	10.5	16.5	14.7	11

Valve positions	2	3	4	5	6	7	8	9	10	12	14	16
L1 [mm]	42.5	53	63.5	74	84.5	96	106.5	116	126.5	147.5	168.5	189.5
L2 [mm]	28.5	39	49.5	60	70.5	81	91.5	102	112.5	133.5	154.5	175.5
L4 [mm]	35.5	46	56.5	67	77.5	89	99.5	109	119.5	140.5	161.5	182.5

Pneumatic valves VUWG-B10A, sub-base valves

Ordering data

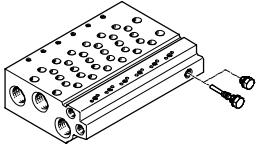

Technical data – Manifold rails ¹⁾									
	Port			CRC	Material ³⁾	Operating pressure [bar]	Max. tightening torque for assembly [Nm]		
	2, 4	1, 3, 5	12/14, 82/84				Valve	H-rail	Wall
	M5	M7	M5	2 ²⁾	Wrought aluminium alloy	-0.9 ... 10	0.45	1.5	1.5

- 1) Blanking plugs are included with the manifold rail.
- 2) Corrosion resistance class 2 according to Festo standard 940 070
Components subject to moderate corrosion stress. Externally visible parts with primarily decorative surface requirements which are in direct contact with a normal industrial environment or media such as coolants or lubricating agents.
- 3) Note on materials: RoHS-compliant.

Order code – Manifold rails M3

VABM	-	L1	-	10A	W	-	M7	-	
Manifold assembly parts									
Manifold rail		VABM							Number of valve positions
									2 to 10, 12, 14 and 16
Valve series							Ports 1, 3, 5		
VUWG		L1					M7 M7		
Valve width									
10 mm				10A					
Rail with ports 1, 2, 3, 4, 5, 12/14, 82/84									
Port 2 and 4 in M5									
					W				

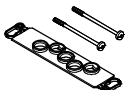

Ordering data – Accessories

				Part No.	Type
Blanking plate				Technical data → Internet: vabb	
	For manifold rail 10AW	Incl. screws and seal		569986	VABB-L1-10A
Separator				Technical data → Internet: vabd	
	For manifold rail 10AW	Separator for pressure zones		570872	VABD-4.2-B
Supply plate				Technical data → Internet: vabf	
	For manifold rail 10AW	Incl. screws and seal		569990	VABF-L1-10A-P3A4-M5
Seals				Technical data → Internet: vabf	
	For sub-base valves B10A	Delivery unit: 10 sets (each with 2 screws and 1 seal)		566671	VABD-L1-10AB-S-M3

Pneumatic valves VUWG-B10, sub-base valves

Technical data

Function
 2x3/2C, 2x3/2U, 2x3/2H
 5/2-way, single pilot
 5/2-way, double pilot
 5/3C, 5/3U, 5/3E

-  - Width 10 mm
 -  - Flow rate
 120 ... 270 l/min



General technical data											
Valve function	T32-A			T32-M			M52-R	B52	M52-M	P53	
Normal position	C ¹⁾	U ²⁾	H ⁴⁾	C ¹⁾	U ²⁾	H ⁴⁾	-	-	-	C ¹⁾ U ²⁾ E ³⁾	
Pneumatic spring reset method	Yes			No			Yes ⁵⁾	-	No	No	
Mechanical spring reset method	No			Yes			Yes ⁵⁾	-	Yes	Yes	
Vacuum operation at port 1	No			Yes			Yes ⁷⁾	Yes			
Vacuum operation at port 3/5	Yes										
Design	Piston spool valve										
Sealing principle	Soft										
Actuation type	Pneumatic										
Type of control	Direct										
Pilot air supply	External										
Exhaust function	With flow control										
Type of mounting	On manifold rail										
Mounting position	Any										
Standard nominal flow rate M5	[l/min]	150			130	120	210		180	200	
Standard nominal flow rate M7	[l/min]	160			140	130	270		230	250	
Switching time on/off	[ms]	4/9			6/7		6/12		-	7/16	8/25
Changeover time	[ms]	-							5	-	11
Width	[mm]	10									
Port	1, 3, 5	G1/8 in manifold rail									
	2, 4	M5/M7 in manifold rail									
	12, 14	M5									
Product weight	[g]	48			51		45	48	41	48	
Corrosion resistance class CRC ⁶⁾	2										

- 1) C = Normally closed
- 2) U=Normally open/mid-position pressurised
- 3) E = Normally exhausted
- 4) H=2x 3/2-way valve in one housing with 1x normally closed and 1x normally open
- 5) Combined reset method
- 6) Corrosion resistance class 2 according to Festo standard 940 070
 Components subject to moderate corrosion stress. Externally visible parts with primarily decorative surface requirements which are in direct contact with a normal industrial environment or media such as coolants or lubricating agents.
- 7) Only with external pilot air supply

Pneumatic valves VUWG-B10, sub-base valves

Technical data

Operating and environmental conditions							
Valve function		T32-A ²⁾	T32-M ³⁾	M52-R ⁴⁾	B52	M52-M ²⁾	P53
Operating medium		Compressed air to ISO 8573-1:2010 [7:4:4]					
Note on operating/pilot medium		Lubricated operation possible (required during subsequent operation)					
Operating pressure	[bar]	1.5 ... 10	-0.9...10	2.5 ... 10	-0.9...10	-0.9...8	-0.9...10
Pilot pressure ¹⁾	[bar]	1.5 ... 10	2 ... 10	2.5 ... 10	1.5 ... 10	3...10	
Ambient temperature	[°C]	-5 ... +60					
Temperature of medium	[°C]	-5 ... +50					

- 1) Note operating pressure/pilot pressure graph → page 4
- 2) Pneumatic spring
- 3) Mechanical spring
- 4) Mixed, pneumatic/mechanical spring

Information on materials	
Housing	Wrought aluminium alloy
Seals	HNBR, NBR
Note on materials	RoHS-compliant

Dimensions Download CAD data → www.festo.com

2x3/2-way, 5/2-way and 5/3-way valve

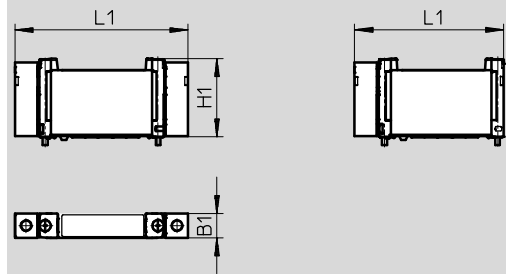

Type	B1	H1	L1
VUWG-B10-...	10.3	32.5	72
VUWG-B10-M52-...			62

Pneumatic valves VUWG-B10, sub-base valves

Order code

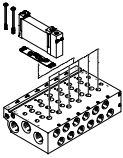
VUWG	-	B	10	-
Valve design				
Sub-base, manifold valve incl. seal and screws		B		
				
Width				
10 mm		10		

-	F
Pneumatic connection	
F	In the manifold rail
Reset method	
A	Pneumatic spring for T32 and M52
M	Mechanical spring for T32 and M52
R	Pneu./mech. spring for M52
-	With B52 and P53

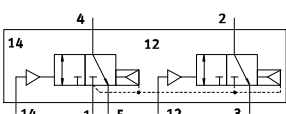
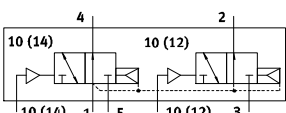
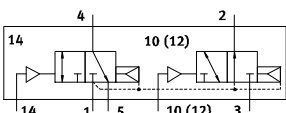
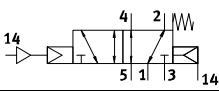
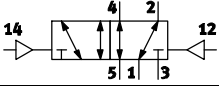
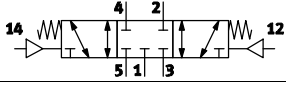
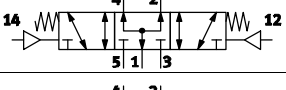
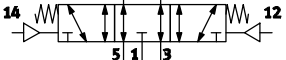
Valve functions	
	T32C
	T32U
	T32H
	M52
	B52
	P53C
	P53U
	P53E

Pneumatic valves VUWG-B10, sub-base valves

Manifold assembly



Sub-base valve for manifold assembly
M5 or M7 connection



Dimensions

Download CAD data → www.festo.com

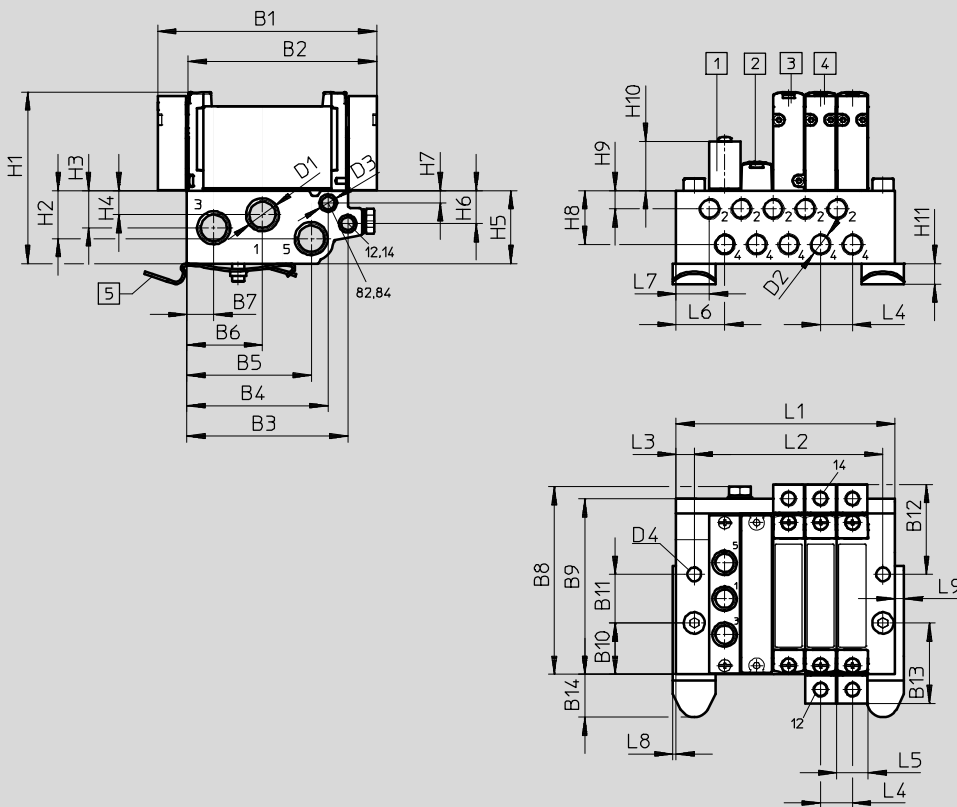

- 1 Supply plate
VABF-L1-10-P3A4-M5
- 2 Blanking plate
VABB-L1-10-W
- 3 Single pilot pneumatic valve,
VUWG-B10-M52
- 4 Double pilot pneumatic valve,
VUWG-B10
- 5 H-rail mounting (two M4x30
screws to DIN 912 are
required)

Type	B1	B2	B3	B4	B5	B6	B7	B8	B9	B10	B11	B12
VABM-L1-...G18	72	62	52.9	46.5	40.9	24.9	8.9	62	57.7	16.9	16	29.5

Type	B13	B14	D1	D2	D3	D4	H1	H2	H3	H4	H5	H6
VABM-L1-...G18	26.5	14.1	G $\frac{1}{8}$	M5	M5	4.5	56.4	15.7	12.2	7.9	23.9	10.8

Type	H7	H8	H9	H10	H11	L3	L4	L5	L6	L7	L8	L9	L15
VABM-L1-...G18	4	17.6	5.9	16.2	6.8	4	10.5	10.3	16	11	1	3	10

Valve positions	2	3	4	5	6	7	8	9	10	12	14	16	22
L1 [mm]	48.5	59	69.5	80	90.5	101	111.5	122	132.5	153.5	174.5	195.5	258.5
L2 [mm]	30.5	41	51.5	62	72.5	83	93.5	104	114.5	135.5	156.5	177.5	240.5

Pneumatic valves VUWG-B10, sub-base valves

Ordering data

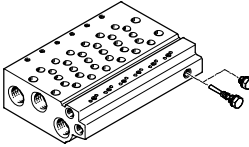

Technical data – Manifold rails ¹⁾									
	Port			CRC	Material ³⁾	Operating pressure [bar]	Max. tightening torque for assembly [Nm]		
	2, 4	1, 3, 5	12/14, 82/84				Valve	H-rail	Wall
	M5 or M7	G1/8	M5	2 ²⁾	Wrought aluminium alloy	-0.9 ... 10	0.45	1.5	3

- 1) Blanking plugs are included with the manifold rail.
- 2) Corrosion resistance class 2 according to Festo standard 940 070
Components subject to moderate corrosion stress. Externally visible parts with primarily decorative surface requirements which are in direct contact with a normal industrial environment or media such as coolants or lubricating agents.
- 3) Note on materials: RoHS-compliant.

Order code – Manifold rails M5 and M7

VABM	-	L1	-	10	-	G18	-	
Manifold assembly parts						Number of valve positions		
Manifold rail		VABM				2 to 10, 12, 14 and 16		
Valve series						Ports 1, 3, 5		
VUWG		L1				G18 G1/8		
Valve width								
10 mm								10
Manifold rail with ports 1, 2, 3, 4, 5, 12/14, 82/84								
Port 2 and 4 in M5								W
Port 2 and 4 in M7								HW

Ordering data – Accessories

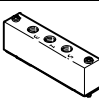
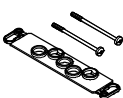
				Part No.	Type
Blanking plate Technical data → Internet: vabb					
	For manifold rail 10W/10HW, sub-base valves	Incl. screws and seal		566495	VABB-L1-10-W
Separator Technical data → Internet: vabd					
	For manifold rail 10W and 10HW, sub-base valves	Separator for pressure zones		569994	VABD-6-B
Supply plate Technical data → Internet: vabf					
	For manifold rail 10W	Incl. screws and seal		569991	VABF-L1-10-P3A4-M5
	For manifold rail 10HW			569992	VABF-L1-10-P3A4-M7
Seals Technical data → Internet: vabd					
	For sub-base valves B10	Delivery unit: 10 sets (each with 2 screws and 1 seal)		566674	VABD-L1-10B-S-M7

Pneumatic valves VUWG-B14, sub-base valves

FESTO

Technical data

Function

2x3/2C, 2x3/2U, 2x3/2H

5/2-way, single pilot

5/2-way, double pilot

5/3C, 5/3U, 5/3E

-  - Width 14 mm

-  - Flow rate
410 ... 580 l/min



General technical data												
Valve function	T32-A			T32-M			M52-A	B52	M52-M	P53		
Normal position	C ¹⁾	U ²⁾	H ⁴⁾	C ¹⁾	U ²⁾	H ⁴⁾	-	-	-	C ¹⁾	U ²⁾	E ³⁾
Pneumatic spring reset method	Yes			No			Yes	-	No	No		
Mechanical spring reset method	No			Yes			No	-	Yes	Yes		
Vacuum operation at port 1	No			Yes			No	Yes				
Vacuum operation at port 3/5	Yes											
Design	Piston spool valve											
Sealing principle	Soft											
Actuation type	Pneumatic											
Type of control	Direct											
Pilot air supply	External											
Exhaust function	With flow control											
Type of mounting	On manifold rail											
Mounting position	Any											
Standard nominal flow rate	[l/min]	540	510	540	430	410	580			540	510	
Switching time on/off	[ms]	6/19			9/13		12/22	-	12/32	8/30		
Changeover time	[ms]	-						6	-	16		
Width	[mm]	14										
Port	1, 3, 5	G1/4 in manifold rail										
	2.4	G1/8 in manifold rail										
	12, 14	M5										
Product weight	[g]	83			83		75	81				
Corrosion resistance class CRC ⁵⁾		2										

1) C = Normally closed

2) U = Normally open/mid-position pressurised

3) E = Normally exhausted

4) H = 2x3/2-way valve in one housing with 1x normally closed and 1x normally open

5) Corrosion resistance class 2 according to Festo standard 940 070

Components subject to moderate corrosion stress. Externally visible parts with primarily decorative surface requirements which are in direct contact with a normal industrial environment or media such as coolants or lubricating agents.

Pneumatic valves VUWG-B14, sub-base valves

Technical data

Operating and environmental conditions						
Valve function	T32-A ²⁾	T32-M ³⁾	M52-A ²⁾	B52	M52-M ³⁾	P53
Operating medium	Compressed air to ISO 8573-1:2010 [7:4:4]					
Note on operating/pilot medium	Lubricated operation possible (required during subsequent operation)					
Operating pressure [bar]	1.5 ... 10	-0.9 ... 10	2.5 ... 10	-0.9 ... 10	-0.9 ... 8	-0.9 ... 10
Pilot pressure ¹⁾ [bar]	1.5 ... 10	2 ... 10	2.5 ... 10	1.5 ... 10	3 ... 10	
Ambient temperature [°C]	-5 ... +60					
Temperature of medium [°C]	-5 ... +50					

1) Note operating pressure/pilot pressure graph → page 4

2) Pneumatic spring

3) Mechanical spring

Information on materials	
Housing	Wrought aluminium alloy
Seals	HNBR, NBR
Note on materials	RoHS-compliant

Dimensions Download CAD data → www.festo.com

2x3/2-way, 5/2-way and 5/3-way valve

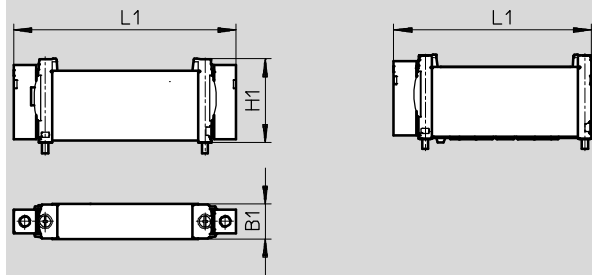



Type	B1	H1	L1
VUWG-B14-...	14.4	34.8	92.6
VUWG-B14-M52-...			82.3

Pneumatic valves VUWG-B14, sub-base valves

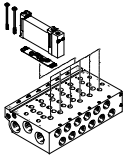
Order code

VUWG	-	B	14	-	-
Valve design					
Sub-base, manifold valve incl. seal and screws		B			
					
Width					
10 mm		14			

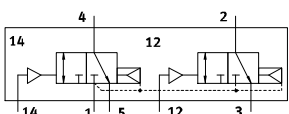
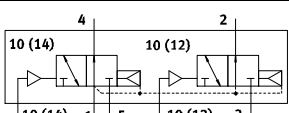
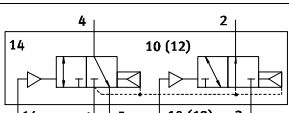
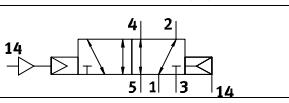
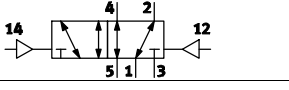
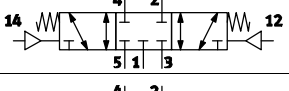
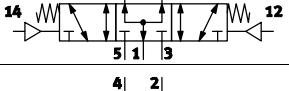
-	F
Pneumatic connection	
F	In the manifold rail
Reset method	
A	Pneumatic spring for T32 and M52
M	Mechanical spring for T32 and M52
-	With B52 and P53

Valve functions	
	T32C
	T32U
	T32H
	M52
	B52
	P53C
	P53U
	P53E

Pneumatic valves VUWG-B14, sub-base valves



Manifold assembly

Sub-base valve for manifold assembly
G $\frac{1}{8}$ connection



Dimensions

Download CAD data → www.festo.com

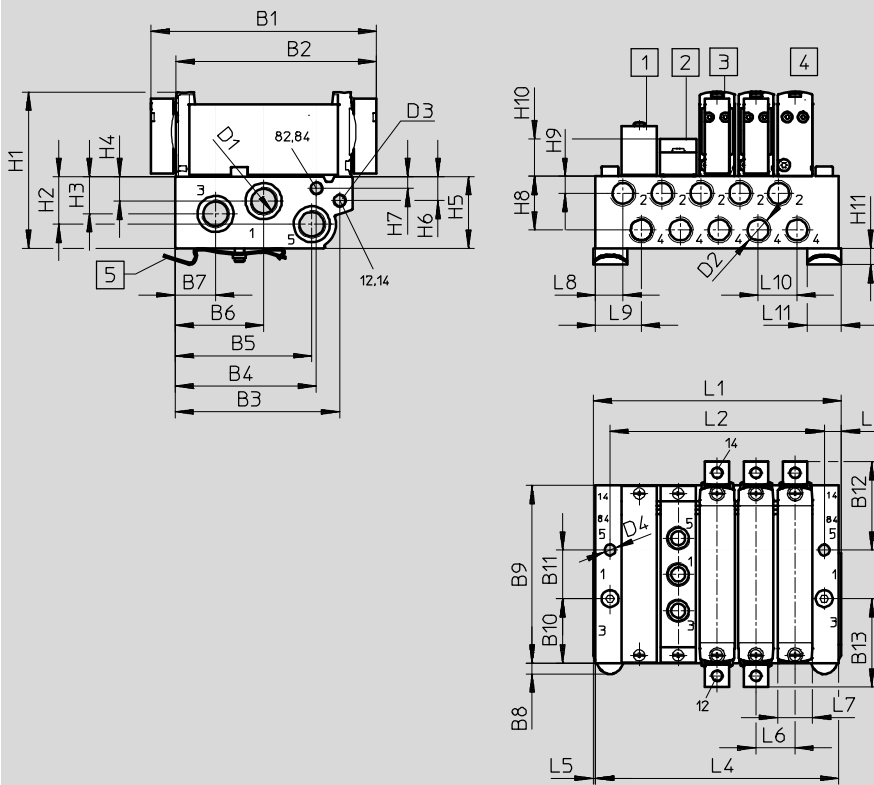

- | | | | | | |
|---|----------------------------------|---|------------------------------|---|--|
| 1 | Blanking plate VABB-L1-14 | 3 | Double pilot pneumatic valve | 5 | H-rail mounting (two M4x25 screws to DIN 912 are required) |
| 2 | Supply plate VABF-L1-14-P3A4-G18 | 4 | Single pilot pneumatic valve | | |

Type	B1	B2	B3	B4	B5	B6	B7	B8	B9	B10	B11	B12
VUWG-B14 -...-F- ...	92.6	82.3	67.7	58.2	56.3	36.6	16.7	4.5	72.9	26.5	20	36.3

Type	B13	D1	D2	D3	D4	H1	H2	H3	H4	H5	H6	H7
VUWG-B14 -...-F- ...	36.3	G $\frac{1}{4}$	G $\frac{1}{8}$	M5	∅ 4.5	64.3	19.6	15.3	10.1	29.5	9.8	4.8

Type	H8	H9	H10	H11	L3	L5	L6	L7	L8	L9	L10	L11
VUWG-B14 -...-F- ...	22.1	7	15.4	6.8	6	1	16	14.4	11.3	18.5	16	14

Valve positions	2	3	4	5	6	7	8	9	10	12	14	16
L1 [mm]	56.3	72.3	88.3	104.3	120.3	136.3	152.3	168.3	184.3	216.3	248.3	280.3
L2 [mm]	40	56	72	88	104	120	136	152	168	200	232	264
L4 [mm]	54.3	70.3	86.3	102.3	118.3	134.3	150.3	166.3	182.3	214.3	246.6	278.3

Pneumatic valves VUWG-B14, sub-base valves

Ordering data

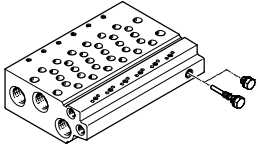

Technical data – Manifold rails ¹⁾									
	Port			CRC	Material ³⁾	Operating pressure [bar]	Max. tightening torque for assembly [Nm]		
	2, 4	1, 3, 5	12/14, 82/84				Valve	H-rail	Wall
	G $\frac{1}{8}$	G $\frac{1}{4}$	M5	2 ²⁾	Wrought aluminium alloy	-0.9 ... 10	0.65	1.5	3

- 1) Blanking plugs are included with the manifold rail.
- 2) Corrosion resistance class 2 according to Festo standard 940 070
Components subject to moderate corrosion stress. Externally visible parts with primarily decorative surface requirements which are in direct contact with a normal industrial environment or media such as coolants or lubricating agents.
- 3) Note on materials: RoHS-compliant

Order code – Manifold rails G $\frac{1}{8}$

VABM	-	L1	-	14	W	-	G14	-	
Manifold assembly parts									Number of valve positions
Manifold rail		VABM							2 to 10, 12, 14 and 16
Valve series									Ports 1, 3, 5
VUWG		L1					G14		G $\frac{1}{4}$
Valve width									
14 mm					14				
Manifold rail with ports 1, 2, 3, 4, 5, 12/14, 82/84									
Ports 2 and 4 in G $\frac{1}{8}$									
									W

Ordering data – Accessories

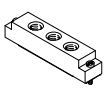
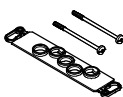
			Part No.	Type
Blanking plate				
	For manifold rail 14W, sub-base valves	Incl. screws and seal	569989	VABB-L1-14
			Technical data → Internet: vabb	
Separator				
	For manifold rail 14W, sub-base valves	Separator for pressure zones	569996	VABD-10-B
			Technical data → Internet: vabd	
Supply plate				
	For manifold rail 14W	Incl. screws and seal	569993	VABF-L1-14-P3A4-G18
			Technical data → Internet: vabf	
Seals				
	For sub-base valves B14	Delivery unit: 10 sets (each with 2 screws and 1 seal)	566676	VABD-L1-14B-S-G18
			Technical data → Internet: vabd	

Pneumatic valves VUWG-B18, sub-base valves

Technical data

Function

2x3/2C, 2x3/2U, 2x3/2H

5/2-way, single pilot

5/2-way, double pilot

5/3C, 5/3U, 5/3E

 - Width 18 mm

 - Flow rate
900 ... 1,000 l/min

General technical data													
Valve function	T32-A			T32-M			M52-R	B52	M52-M	P53			
Normal position	C ¹⁾	U ²⁾	H ⁴⁾	C ¹⁾	U ²⁾	H ⁴⁾	–	–	–	C ¹⁾	U ²⁾	E ³⁾	
Pneumatic spring reset method	Yes			No			Yes ⁵⁾	–	No	No			
Mechanical spring reset method	No			Yes			Yes ⁵⁾	–	Yes	Yes			
Vacuum operation at port 1	No			Yes			No	Yes					
Vacuum operation at port 3/5	Yes												
Design	Piston spool valve												
Sealing principle	Soft												
Actuation type	Pneumatic												
Type of control	Direct												
Pilot air supply	External												
Exhaust function	With flow control												
Type of mounting	On manifold rail												
Mounting position	Any												
Standard nominal flow rate	[l/min]	900			1,000						950		
Switching time on/off	[ms]	12/36			17/25			16/40		–	12/59		17/69
Changeover time	[ms]	–											
Width	[mm]	18											
Port	1, 3, 5	G $\frac{3}{8}$ in manifold rail											
	2, 4	G $\frac{1}{4}$ in manifold rail											
	12, 14	M5											
Product weight	[g]	83			83			75		81			
Corrosion resistance class CRC ⁶⁾	2												

1) C = Normally closed

2) U = Normally open/mid-position pressurised

3) E = Normally exhausted

4) H = 2x 3/2-way valve in one housing with 1x normally closed and 1x normally open

5) Combined reset method

6) Corrosion resistance class 2 according to Festo standard 940 070

Components subject to moderate corrosion stress. Externally visible parts with primarily decorative surface requirements which are in direct contact with a normal industrial environment or media such as coolants or lubricating agents.

Pneumatic valves VUWG-B18, sub-base valves

Technical data

Operating and environmental conditions							
Valve function	T32-A ²⁾	T32-M ³⁾	M52-R ⁴⁾	B52	M52-M ³⁾	P53	
Operating medium	Compressed air to ISO 8573-1:2010 [7:4:4]						
Note on operating/pilot medium	Lubricated operation possible (required during subsequent operation)						
Operating pressure [bar]	1.5 ... 10	-0.9 ... 10	2.5 ... 10	-0.9 ... 10	-0.9 ... 8	-0.9 ... 10	
Pilot pressure ¹⁾ [bar]	1.5 ... 10	2 ... 10	2.5 ... 10	1.5 ... 10	3 ... 10		
Ambient temperature [°C]	-5 ... +60						
Temperature of medium [°C]	-5 ... +50						

- 1) Note operating pressure/pilot pressure graph → page 4
- 2) Pneumatic spring
- 3) Mechanical spring
- 4) Mixed, pneumatic/mechanical spring

Information on materials	
Housing	Wrought aluminium alloy
Seals	HNBR, NBR
Note on materials	RoHS-compliant

Dimensions Download CAD data → www.festo.com

2x3/2-way, 5/2-way and 5/3-way valve

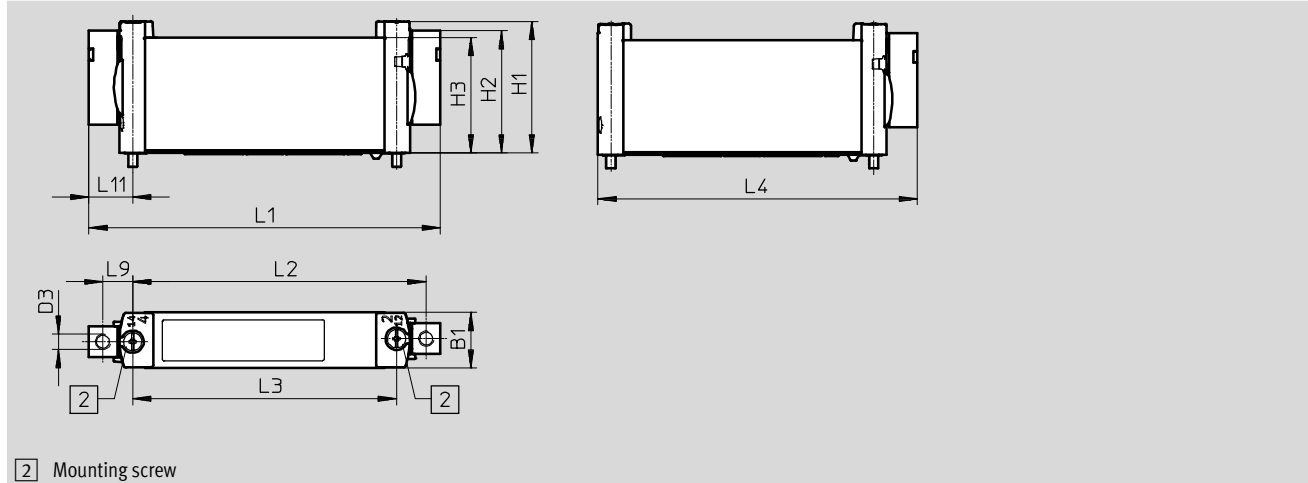

2 Mounting screw

Type	B1	D3	H1	H2	H3	L1	L2	L3	L4	L9	L11
VUWG-B18-...	18.3	M5	43.1	40	37.8	115	96.1	86.4	105	9.7	14.3

Pneumatic valves VUWG-B18, sub-base valves

Order code

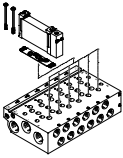
VUWG	-	B	18	-
Valve design				
Sub-base, manifold valve incl. seal and screws		B		
				
Width				
18 mm		18		

-	F
Pneumatic connection	
F	In the manifold rail
Reset method	
A	Pneumatic spring for T32 and M52
M	Mechanical spring for T32 and M52
R	Pneu./mech. spring for M52
-	With B52 and P53

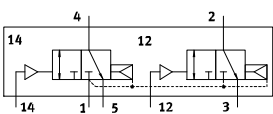
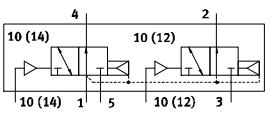
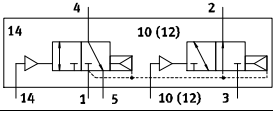
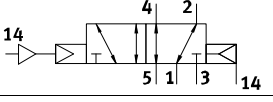
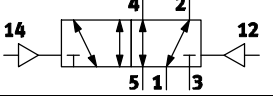
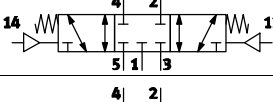
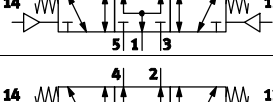
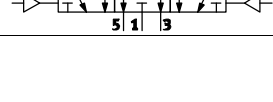
Valve functions	
	T32C
	T32U
	T32H
	M52
	B52
	P53C
	P53U
	P53E

Pneumatic valves VUWG-B18, sub-base valves

Manifold assembly

Sub-base valve for manifold assembly
G $\frac{3}{8}$ connection



Dimensions

Download CAD data → www.festo.com

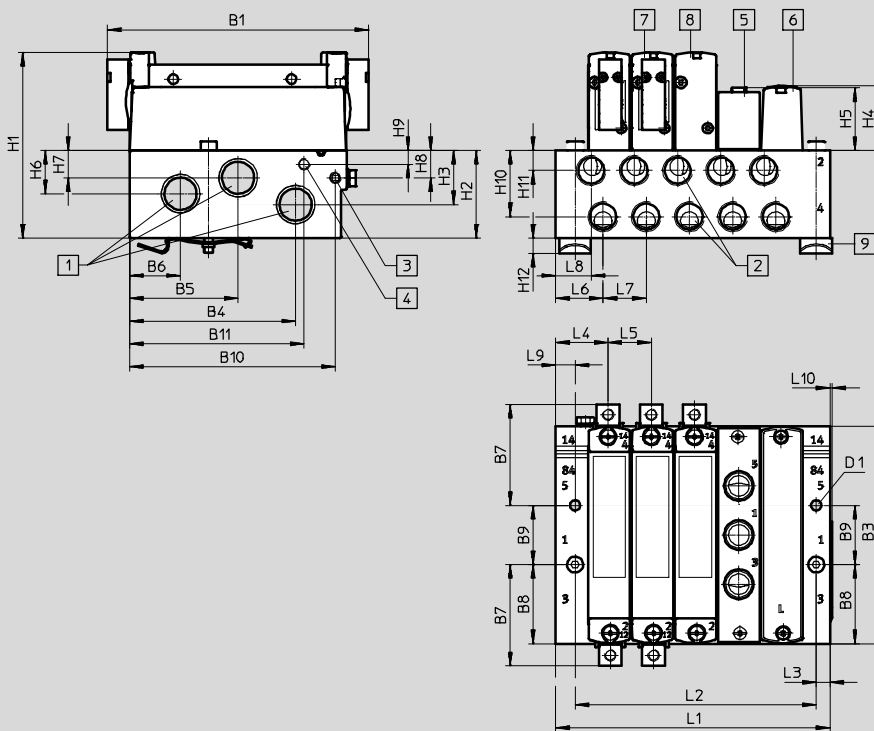

- 1 Ports 1, 3 and 5: G $\frac{3}{8}$ (at both ends)
- 2 Ports 2 and 4: G $\frac{1}{4}$
- 3 Port 12/14 for external pilot air: M5
- 4 Port 82/84 for external pilot air: M5
- 5 Supply plate VABF-L1-18-P3A4-G14
- 6 Blanking plate VABB-L1-18
- 7 Double pilot pneumatic valve
- 8 Single pilot pneumatic valve
- 9 H-rail mounting (two M4x40 screws to DIN 912 are required for mounting)

Type	B1	B3	B4	B5	B6	B7	B8	B9	B10	B11	D1	H1
VUWG-B14 -...-F- ...	115	95.6	73.1	47.8	22.5	51.7	34.8	26	90.6	76.8	4.5	81.6

Type	H2	H3	H4	H5	H6	H7	H8	H9	H10	H11	H12	L3
VUWG-B14 -...-F- ...	38.5	23.8	28.4	27.6	19	12	12.1	6.1	29.1	8.8	6.5	6

Type	L4	L5	L6	L7	L8	L9	L10
VUWG-B14 -...-F- ...	23	19	20.8	19	15.6	8.5	1

Valve positions	2	3	4	5	6	7	8	9	10	12	14	16
L1 [mm]	63.5	82.5	101.5	120.5	139.5	158.5	177.5	196.5	215.5	253.5	291.5	329.5
L2 [mm]	49	68	87	106	125	144	163	182	201	239	277	315

Pneumatic valves VUWG-B18, sub-base valves

Ordering data

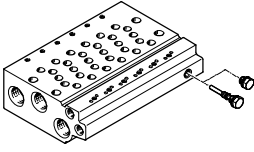

Technical data – Manifold rails ¹⁾									
	Port			CRC	Material ³⁾	Operating pressure [bar]	Max. tightening torque for assembly [Nm]		
	2, 4	1, 3, 5	12/14, 82/84				Valve	H-rail	Wall
	G $\frac{1}{4}$	G $\frac{3}{8}$	M5	2 ²⁾	Wrought aluminium alloy	-0.9 ... 10	0.65	1.5	3

- Blanking plugs are included with the manifold rail.
- Corrosion resistance class 2 according to Festo standard 940 070
Components subject to moderate corrosion stress. Externally visible parts with primarily decorative surface requirements which are in direct contact with a normal industrial environment or media such as coolants or lubricating agents.
- Note on materials: RoHS-compliant.

Order code – Manifold rails G $\frac{1}{4}$

VABM	-	L1	-	18	W	-	G38	-	
Manifold assembly parts									Number of valve positions
Manifold rail		VABM							2 to 10, 12, 14 and 16
Valve series							Ports 1, 3, 5		
VUWG		L1					G38	G $\frac{3}{8}$	
Valve width									
18 mm					18				
Manifold rail with ports 1, 2, 3, 4, 5, 12/14, 82/84									
Ports 2 and 4 in G $\frac{1}{4}$					W				



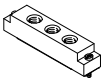
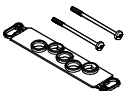

Ordering data – Accessories

			Part No.	Type
Blanking plate Technical data → Internet: vabb				
	For manifold rail 18W, sub-base valves	Incl. screws and seal	574482	VABB-L1-18
Separator Technical data → Internet: vabd				
	For manifold rail 18W, sub-base valves	Separator for pressure zones	574483	VABD-14-B
Supply plate Technical data → Internet: vabf				
	For manifold rail 18W	Incl. screws and seal	574481	VABF-L1-18-P3A4-G14
Seals Technical data → Internet: vabd				
	For sub-base valves B18	Delivery unit: 10 sets (each with 2 screws and 1 seal)	574480	VABD-L1-18B-S-G14

Pneumatic valves VUWG

Accessories



FESTO

Ordering data				
	Description		Part No.	Type
Pneumatic silencer			Technical data → Internet: u	
	For thread M5	1 piece	165003	UC-M5
	For thread M7		161418	UC-M7
	For thread G1/8	50 pieces	534222	U-1/8-50
		1 piece	161419	UC-1/8
	For thread G1/4	20 pieces	534220	UC-1/4-20
			534223	U-1/4-20
Fittings			Technical data → Internet: qs	
	For tubing Ø 3 mm	10 pieces	133003	QSM-M5-3-I-R
	For tubing Ø 4 mm		133004	QSM-M5-4-I-R
	For tubing Ø 6 mm		133005	QSM-M5-6-I-R
	For tubing Ø 6 mm		133007	QSM-M7-6-I-R
	For tubing Ø 3 mm		153313	QSM-M5-3-I
	For tubing Ø 4 mm		153315	QSM-M5-4-I
	For tubing Ø 4 mm		153319	QSM-M7-4-I
	For tubing Ø 4 mm	10 pieces	186106	QS-G1/8-4-I
	For tubing Ø 6 mm		186107	QS-G1/8-6-I
	For tubing Ø 8 mm		186109	QS-G1/8-8-I
	For tubing Ø 8 mm	20 pieces	130995	QS-B-1/4-8-I-20
	For tubing Ø 10 mm		132152	QS-B-1/4-10-I-20
	For tubing Ø 12 mm		132153	QS-B-1/4-12-I-20
	For tubing Ø 10 mm		132151	QS-B-1/8-10-I-20
	For tubing Ø 6 mm	10 pieces	186117	QSL-G1/8-6
	For tubing Ø 8 mm		186119	QSL-G1/8-8
	For tubing Ø 8 mm	20 pieces	130931	QSL-B-1/4-8-20
	For tubing Ø 10 mm		132127	QSL-B-1/4-10-20
	For tubing Ø 12 mm		132128	QSL-B-1/4-12-20
	For tubing Ø 10 mm		132126	QSL-B-1/8-10-20
	For tubing Ø 6 mm	10 pieces	186128	QSLL-G1/8-6
	For tubing Ø 8 mm		186130	QSLL-G1/8-8
	For tubing Ø 6 mm	20 pieces	132111	QSML-B-1/8-6-20
	For tubing Ø 3 mm	10 pieces	153331	QSML-M5-3
	For tubing Ø 4 mm		153333	QSML-M5-4
	For tubing Ø 4 mm		186352	QSML-M7-4
	For tubing Ø 3 mm		130838	QSMLL-M5-3
	For tubing Ø 4 mm		153339	QSMLL-M5-4
For tubing Ø 4 mm	186354		QSMLL-M7-4	
For tubing Ø 4 mm				
Blanking plug			Technical data → Internet: b	
	For thread M5	10 pieces	174308	B-M5-B
	For thread M7		174309	B-M7
	For thread G1/8		3568	B-1/8
	For thread G1/4		3569	B-1/4
Compact blanking plug, for valve			Technical data → Internet: npqh	
	For sealing a connection (valve requires a blanking plug with a low screw-in depth)	For valve size 14 (G1/8), 10 pieces	578406	NPQH-BK-G18-P10
		For valve size 18 (G1/4), 10 pieces	578407	NPQH-BK-G14-P10

Pneumatic valves VUWG

Accessories

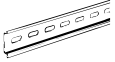
FESTO

Ordering data						
Description		Part No.		Type		
H-rail Technical data → Internet: nrh						
	To EN 60715, 35 x 7.5 (WxH)	2 m	35430	NRH-35-2000		
H-rail mounting Technical data → Internet: vame						
	-	2 pieces	569998	VAME-T-M4		
Flow control valve						
	For M5 valves, for setting the flow rate during pressurisation and exhausting (10 pieces)	Flow rate: 9.6 l/min	b value: 0.5	C value: 0.04	8025709	VFFG-T-M5-5
		Flow rate: 14.6 l/min	b value: 0.5	C value: 0.05	8025710	VFFG-T-M5-6
		Flow rate: 19.1 l/min	b value: 0.5	C value: 0.07	8025711	VFFG-T-M5-7
		Flow rate: 26.1 l/min	b value: 0.5	C value: 0.10	8025712	VFFG-T-M5-8
		Flow rate: 40.8 l/min	b value: 0.5	C value: 0.14	8025713	VFFG-T-M5-10
		Flow rate: 45.4 l/min	b value: 0.5	C value: 0.16	8025714	VFFG-T-M5-12
Flow rate: 67.4 l/min	b value: 0.5	C value: 0.25	8025715	VFFG-T-M5-15		