

# Valve terminals MPA-S

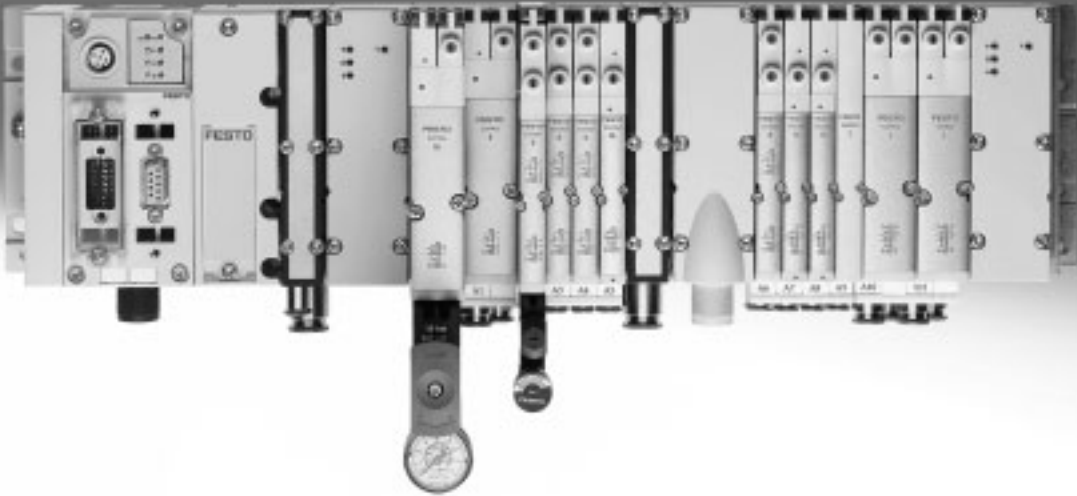

# Valve terminals MPA-S

Key features

FESTO

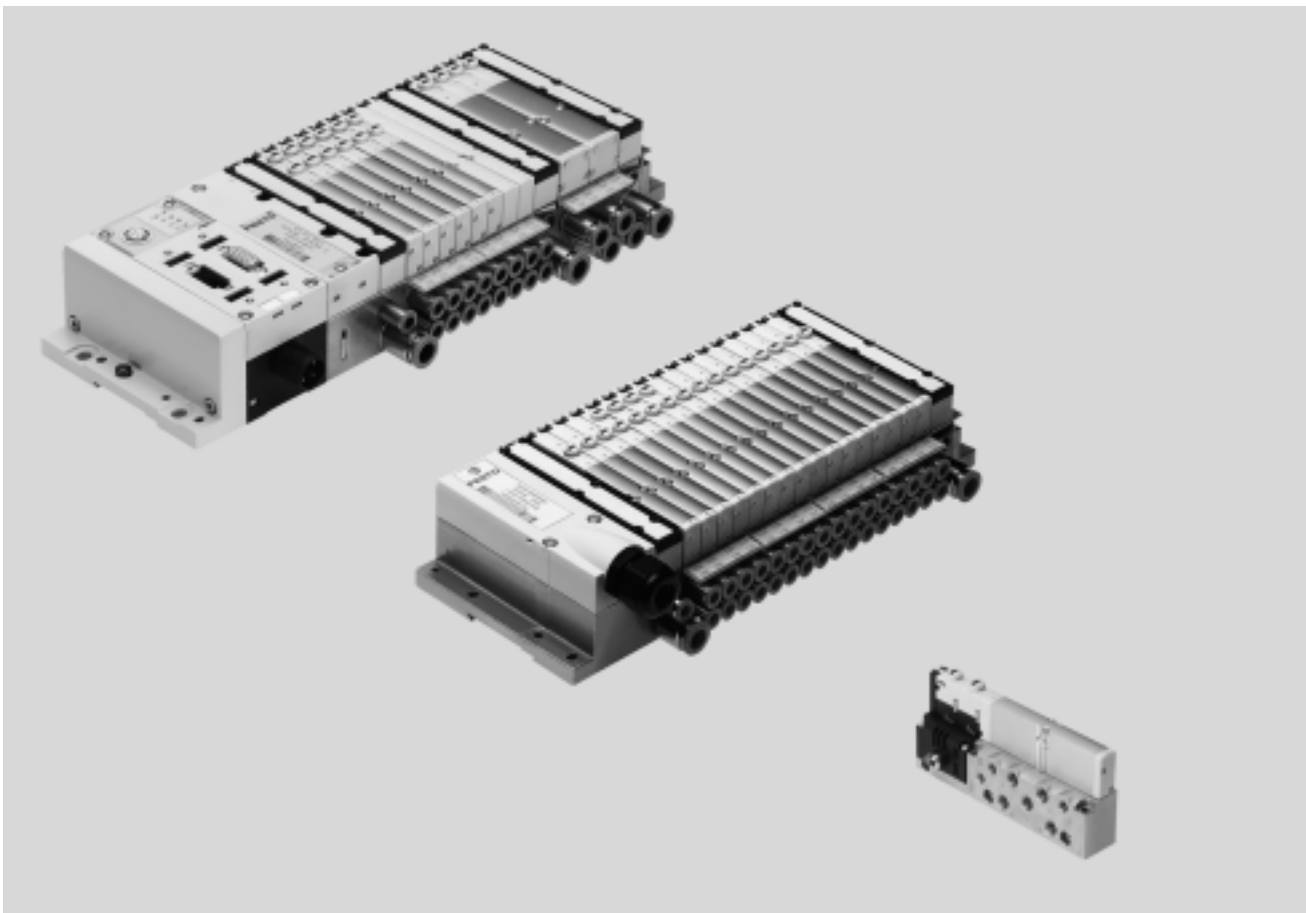

## Innovative

- Slim high-performance valves in sturdy metal housing
- MPA1 flow rates up to 360 l/min
- MPA2 flow rates up to 700 l/min
- From the individual valve to the valve terminal with multi-pin plug, AS-interface, CPI and fieldbus connections and control block
- Dream team: fieldbus valve terminal suitable for electrical peripherals CPX. This means:
  - Forward-looking internal communication system for actuation of the valves and CPX modules
  - Diagnostics down to the individual valve
  - Valves can be actuated with or without (standard) isolated electrical circuits

## Versatile

- Modular system offering a range of configuration options
- Expandable up to 128 solenoid coils
- Conversion and expansion possible at a later date
- Further manifold blocks can be assembled using just three screws and sturdy separating seals on metal separator plates
- Integration of innovative function modules possible
- Manual regulators, rotatable pressure gauges
- Proportional pressure regulators
- Additional air supply via additional pressure zones using supply plates
- Wide range of pressures –0.9 ... 10 bar
- Wide range of valve functions

## Reliable

- Sturdy and durable metal components
  - Valves
  - Manifold blocks
  - Seals
- Fast troubleshooting thanks to LEDs on the valves and diagnostics via fieldbus
- Extensive operating voltage range  $\pm 25\%$
- Ease of servicing through replaceable valves and electronics modules
- Manual override either non-detenting, detenting or secured against unauthorised activation (covered)
- Durable, thanks to tried and tested piston spool valves
- Large and durable labelling system, suitable for barcodes

## Easy to mount

- Ready-to-install unit, already assembled and tested
- Lower selection, ordering, installation and commissioning costs
- Secure mounting on wall or H-rail mounting

# Valve terminals MPA-S

## Key features

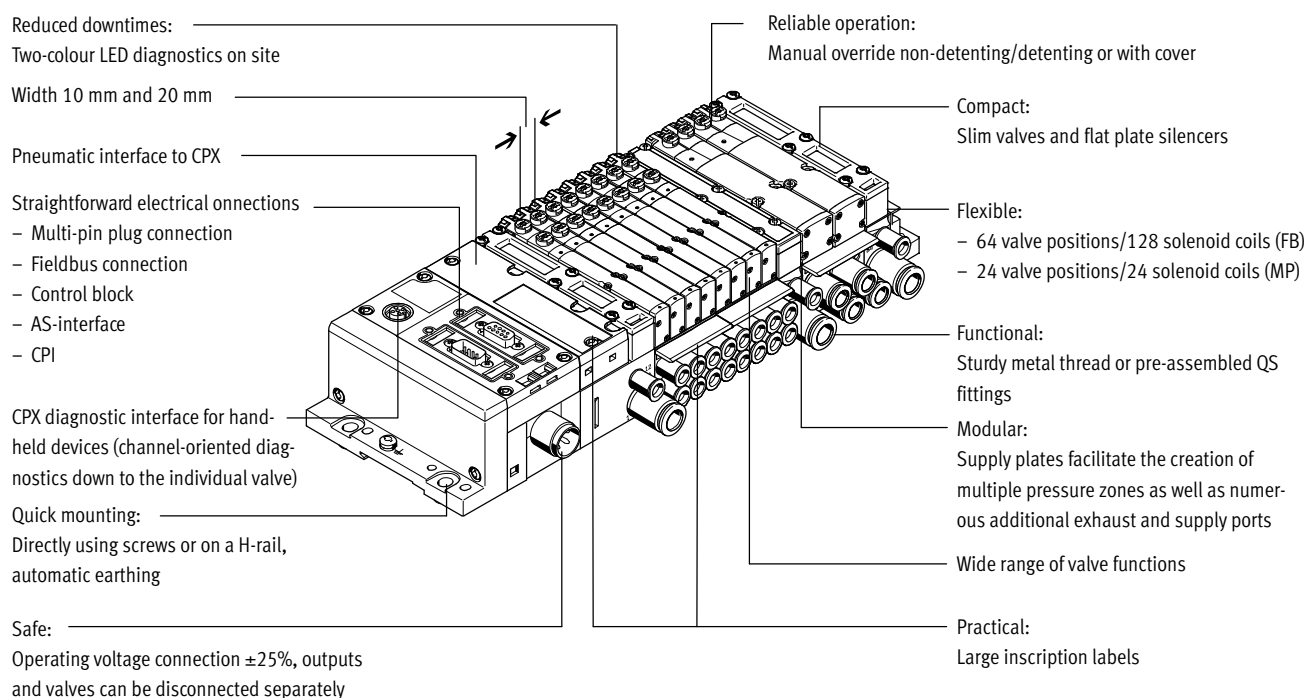

## Equipment options

### Valve functions

- 5/2-way valve, single solenoid
  - 5/2-way valve, double solenoid
  - 2x 3/2-way valve, normally open
  - 2x 3/2-way valve, normally closed
  - 2x 3/2-way valve, 1x normally open, 1x normally closed
  - 5/3-way valve, mid-position pressurised
  - 5/3-way valve, mid-position closed
  - 5/3-way valve, mid-position exhausted
  - 2x 2/2-way valve, 1x normally closed, 1x normally closed, reversible
  - 2x 2/2-way valve, normally closed
  - 1x 3/2-way valve, normally closed, external compressed air supply
  - 1x 3/2-way valve, normally open, external compressed air supply
  - Manual pressure regulators
  - Proportional pressure regulators
  - Pressure sensor
- All valves have the same compact dimensions with an overall length of 107 mm and a width of 10.5 mm or 21 mm. A height of 55 mm makes them a perfect match for the electrical peripherals CPX.

### Special features

#### Multi-pin terminal

- Max. 24 valve positions/ max. 24 solenoid coils
- Parallel modular valve linking via circuit boards
- Electronics module with integrated holding current reduction
- Any compressed air supply
- Creation of pressure zones

#### Fieldbus terminal/control block

- Max. 64 valve positions/ max. 128 solenoid coils
- Internal CPX bus system for valve actuation
- Module for electrical valve actuation, via separate voltage supply or without electrical isolation
- Any compressed air supply
- Creation of pressure zones

#### Individual valve

- Electrical M8 connection, 4-pin with screw connection
- Detachable electronics module with integrated holding current reduction

#### AS-interface

- 2 to 8 valves, freely configurable (max. 8 solenoid coils) with input feedback

#### CPI interface

- Max. 32 valve positions/ max. 32 solenoid coils

#### Combinable

- MPA1 flow rates up to 360 l/min
- MPA2 flow rates up to 700 l/min
- MPA1 and MPA2 can be combined on one valve terminal

### Electrical supply plate

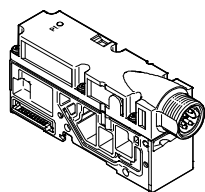

- Increases the maximum number of valve positions possible to 64, with max. 128 solenoid coils
- Creation of isolated, individually disconnectable electrical circuits (voltage zones)
- Greater economy thanks to the higher number of valves/solenoid coils per valve terminal
- Greater safety through individual disconnection of valve groups, for example for EMERGENCY-STOP functions

 Note  
The electrical supply plate is available with either an M18 or 7/8" connection.

# Valve terminals MPA-S

Key features

FESTO

## Valve terminal configurator

Online via: → [www.festo.com](http://www.festo.com)

Selecting an MPA valve terminal using the online catalogue is quick and easy thanks to the convenient valve terminal configurator provided. This makes it much easier to find the right product.

The valve terminals are fully assembled according to your order specifications and are individually tested. This reduces the assembly and installation time to a minimum.

The valve terminal MPA is ordered using the order code.

Ordering system for MPA

→ Internet: mpa

Ordering system for CPX

→ Internet: cpx

## 2D/3D CAD data

Online via: → [www.festo.com](http://www.festo.com)

You can request the CAD data for a valve terminal you have configured. To do so, perform the product search as described above. Go to the shopping basket and click on the CAD icon

(compass). On the next page you can generate a 3D preview or request another data format of your choice by e-mail.

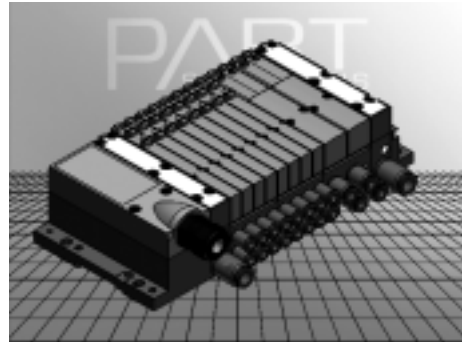

# Valve terminals MPA-S

Key features

## Individual connection

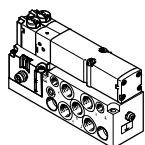

Valves can also be used on individual sub-bases for actuators further away from the valve terminal.

The electrical connection is established using a standard 4-pin M8 plug (EN 60947-5-2).

Further information  
→ VMPA1

## Multi-pin plug connection

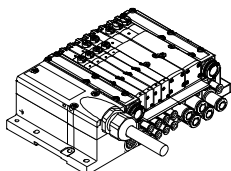

The signal flow from the controller to the valve terminal takes place via a pre-assembled or self-assembled multi-wire cable to the multi-pin plug connection, which substantially reduces installation time.

The valve terminal can be equipped with max. 24 solenoid coils. This corresponds to 4 to 24 MPA1 or 2 to 24 MPA2 valves, or a combination of both.

Versions

- Sub-D connection
- Pre-assembled multi-pin cable
- Multi-pin cable for self-assembly

## AS-interface connection

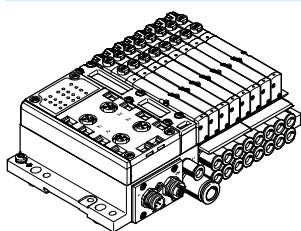

A special feature of the AS-interface is its ability to simultaneously transmit data and supply power via a two-wire cable. The encoded cable profile prevents connection with incorrect polarity. The valve terminal with AS-interface is available in the following versions:

- With two to eight modular valve positions (max. 8 solenoid coils). This corresponds to 2 to 8 MPA1 or 2 to 8 MPA2 valves, or a combination of both.
- With all available valve functions.

The connection technology used for the inputs can be selected as with CPX: M8, M12, Harax, Sub-D, Cage Clamp® (terminals to IP20).

Further information  
→ Internet: as-interface

## CPI installation system

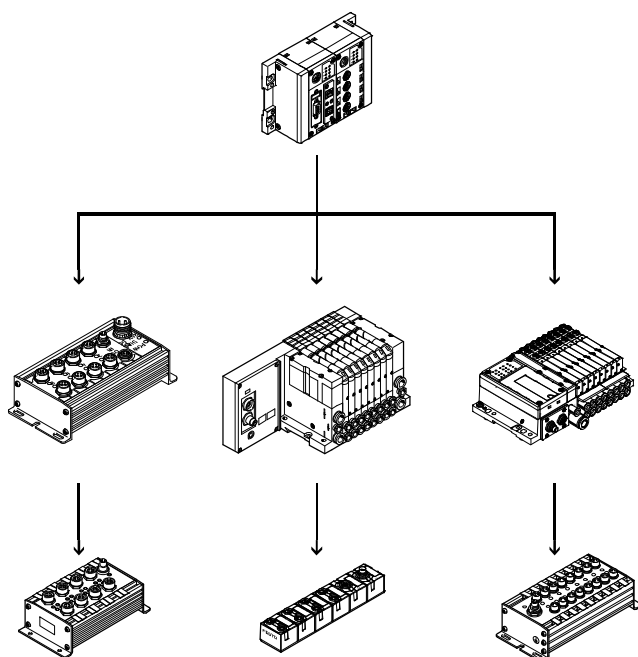

Valve terminal for CPI installation system:

Valve terminals with CP connection are intended for connection to higher-order bus nodes or to control blocks. A bus node or control block also enables the connection of decentralised input/output units. The following bus protocols are supported:

- PROFIBUS DP
- INTERBUS
- DeviceNet
- CANopen
- CC-Link
- EtherNet/IP
- PROFINET
- POWERLINK
- EtherCAT
- Sercos III

Four strings with up to 32 inputs and outputs can be connected to a bus node or control block. The connecting cables transmit the power supply for the input modules and the load voltage for the valves as well as control signals.

Further information  
→ Internet: ctec

# Valve terminals MPA-S

Key features

FESTO

## Fieldbus connection via the CPX system

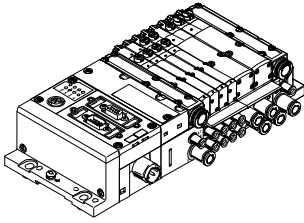

An integrated fieldbus node manages communication with a higher-order PLC. This enables a space-saving pneumatic and electronic solution.

Valve terminals with fieldbus interfaces can be configured with up to 16 manifold blocks. In conjunction with MPA1 and 8 solenoid coils per manifold block, up to 128 solenoid coils can thus be actuated. An MPA2 with 4 solenoid coils per manifold block can actuate 64 solenoid coils.

### Versions

- PROFIBUS DP
- INTERBUS
- DeviceNet
- CANopen
- CC-Link
- EtherNet/IP
- PROFINET
- POWERLINK
- EtherCAT
- Sercos III
- Front End Controller Remote
- Front End Controller Remote I/O
- Modbus/TCP
- CPX terminal
  - ➔ Internet: cpx

## Control block connection via the CPX system

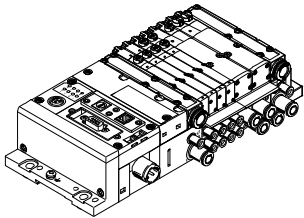

Controllers integrated in the Festo valve terminals enable the construction of stand-alone control units to IP65, without control cabinets.

Using the slave operation mode, these valve terminals can be used for intelligent pre-processing and are therefore ideal modules for designing decentralised intelligence.

In the master operation mode, terminal groups can be designed with many options and functions which can autonomously control a medium-sized machine/system.

- CPX terminal
  - ➔ Internet: cpx

### Note

Note possible restrictions for the IP protection class  
➔ ATEX conformity declaration

# Valve terminals MPA-S

Peripherals overview

## Modular pneumatic components

The modular design of the MPA facilitates maximum flexibility right from the planning stage and offers maximum ease of service in operation.

The system consists of manifold blocks and valves. The manifold blocks are screwed together and thus form the support system for the valves.

They contain the connection ducts for supplying compressed air to and venting from the valve terminal as well as the working lines for the pneumatic drives for each valve.

Each manifold block is connected to the next using three screws. Individual terminal sections can be isolated and further manifold blocks inserted by loosening these screws. This ensures that the valve terminal can be rapidly and reliably extended.

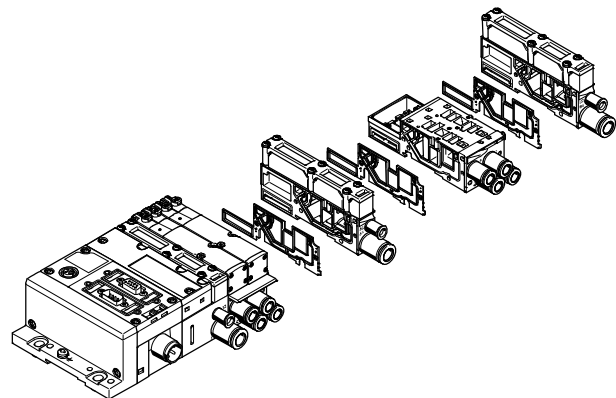
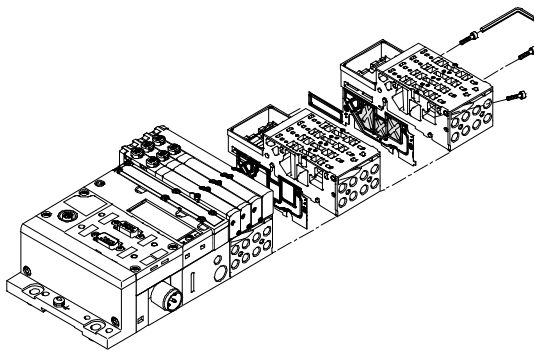

## Modular electrical peripherals

The manner in which the valves are actuated differs according to whether you are using a multi-pin terminal, fieldbus terminal or individual valve. The MPA with CPX interface is based on the internal bus system of the CPX and uses this serial communication system for all solenoid coils and a range of electrical input and output functions.

Serial linking facilitates the following:

- Transmission of switching information
- High valve density
- Compact design
- Position-based diagnostics

- Separate voltage supply for valves
- Flexible conversion without address shifting
- Transmission of status, parameter and diagnostic data  
→ Internet: cpx
- Option of CP interface
- CPX-FEC as stand-alone controller with access via Ethernet and web server

## MPA with electrical peripherals CPX

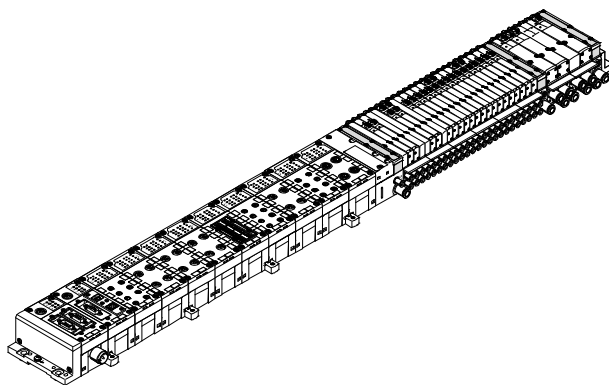

## Modularity with electrical peripherals CPX

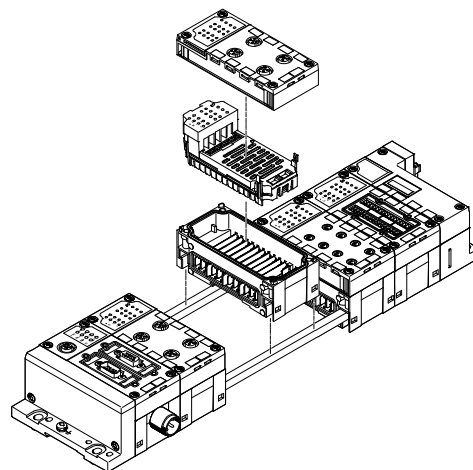

# Valve terminals MPA-S

Peripherals overview

## Individual sub-base

Ordering:

- Using individual part numbers

Individual sub-bases can be equipped with any valve (VMPA... of the corresponding width).

The electrical connection is established using a standard 4-pin M8 plug (EN 60947-5-2).

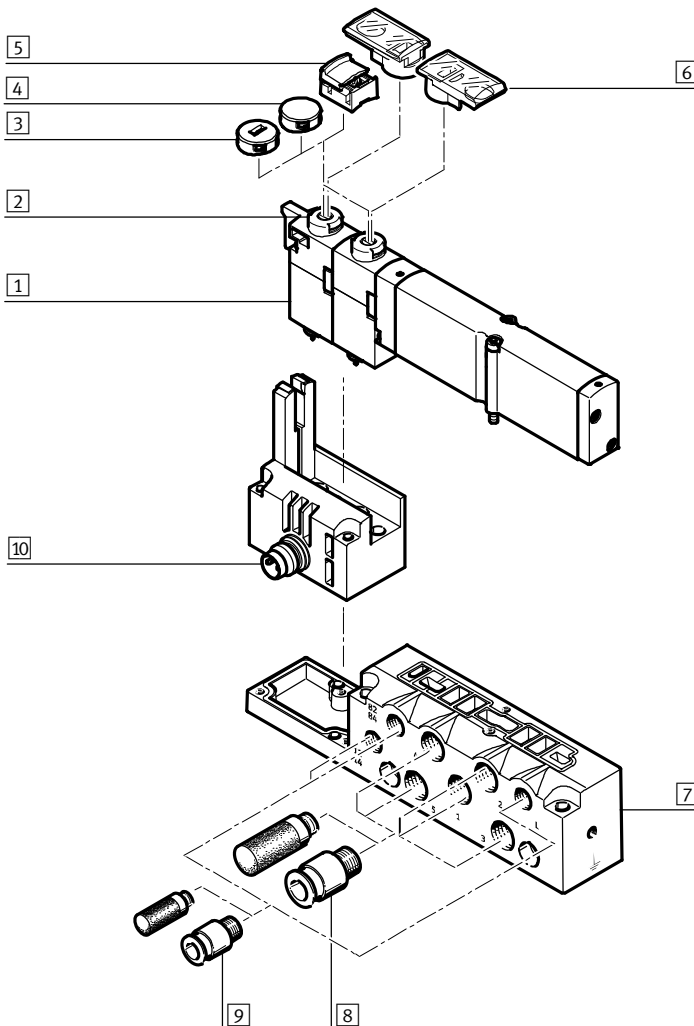

Description	Brief description	→ Page/Internet
1 Solenoid valve	Width 10 mm, 14 mm, 20 mm	VMPA1
2 Manual override (MO)	Non-detenting/turning with detent, per solenoid coil	VMPA1
3 Coded cover cap	Manual override with non-detenting operation only once cover cap fitted	VMPA1
4 Covered cover cap	Manual override blocked once cover cap fitted	VMPA1
5 Cover cap, manual override detenting	Manual override detenting and operable without tools once cover cap fitted	VMPA1
6 Inscription label holder	Can be pushed onto manual override	VMPA1
7 Sub-base	For individual valve VMPA...	VMPA1
8 Fittings and/or silencers	For working ports (2, 4) and air supply/exhaust ports (1, 3, 5)	VMPA1
9 Fittings, silencers or blanking plugs	For pilot air supply/pilot exhaust air (12/14, 82/84) and pressure compensation	VMPA1
10 Electrical connection M8	4-pin	VMPA1



# Valve terminals MPA-S

Peripherals overview

## Pneumatic components of the valve terminal – Multi-pin plug, AS-interface

The manifold blocks are either prepared for:

- 2 or 4 single solenoid valves
- 2 or 4 double solenoid valves depending on the size.

- Double solenoid valve positions can be equipped with any valve or a blanking plate.
- Single solenoid valve positions can only be equipped with single solenoid valves.

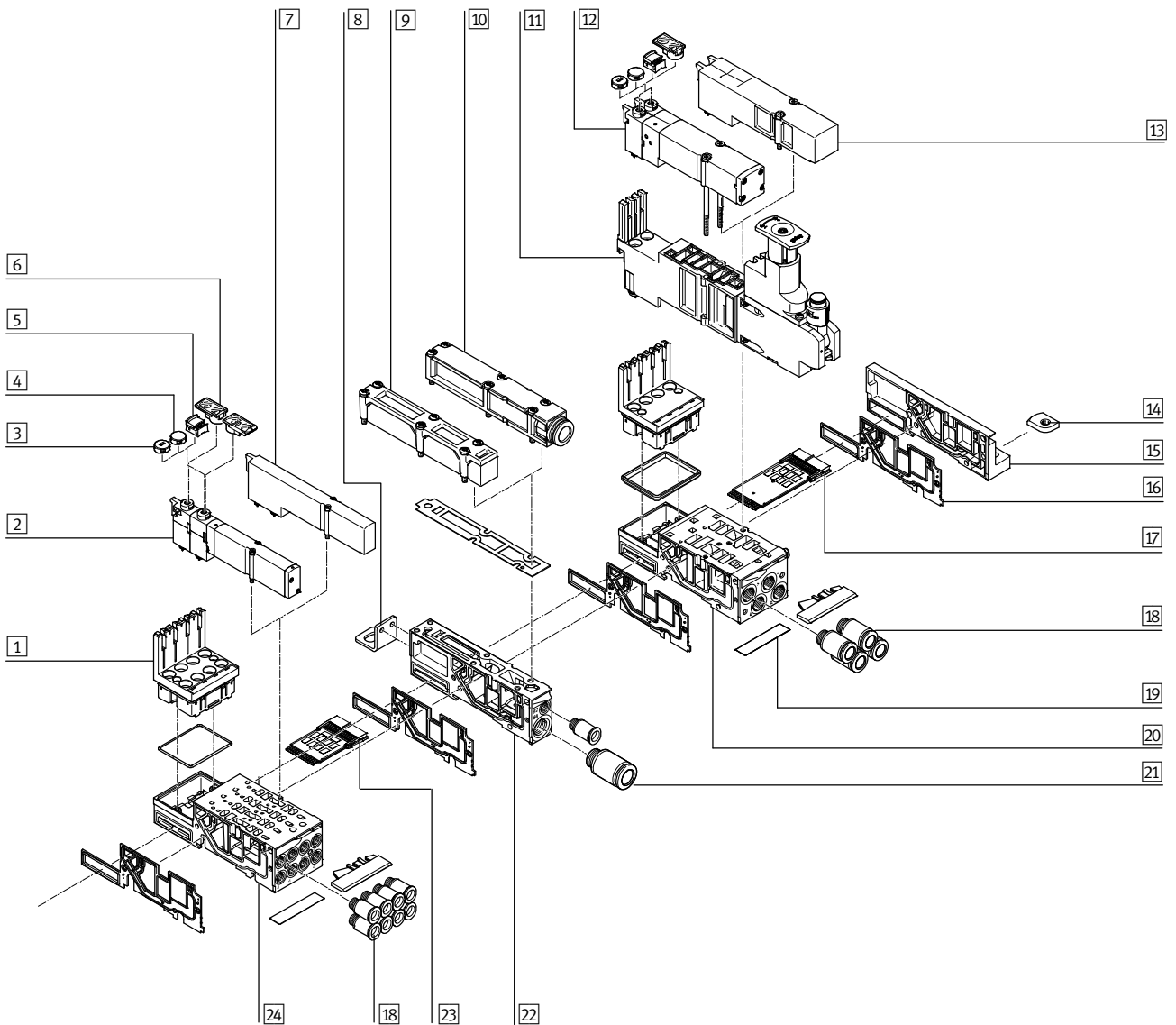

# Valve terminals MPA-S

Peripherals overview

Pneumatic components of the valve terminal – Multi-pin plug, AS-interface		
Designation	Brief description	→ Page/Internet
1 Electronics module	For connecting MPA1 or MPA2 valves	79
2 Solenoid valve	Width 10 mm	73
3 Coded cover cap	Manual override with non-detenting operation only once cover cap fitted	80
4 Cover cap	Manual override blocked once cover cap fitted	80
5 Cover cap, manual override detenting	Manual override detenting and operable without tools once cover cap fitted	80
6 Inscription label holder	Can be pushed onto manual override	83
7 Blanking plate	For unused valve position (vacant position), width 10 mm	80
8 Mounting	Optional for valve terminal mounting (on supply plate)	83
9 Flat plate silencer	–	–
10 Exhaust plate	For ducted exhaust air	80
11 Regulator plate	Vertical stacking (pressure regulator plate, vertical pressure shut-off plate, vertical supply plate)	74
12 Solenoid valve	Width 20 mm	73
13 Blanking plate	For unused valve position (vacant position), width 20 mm	80
14 H-rail mounting	–	83
15 Right-hand end plate	–	78
16 Separating seal	For manifold block	80
17 Fittings	For working lines	82
18 Inscription label	–	83
19 Manifold block	For two valve locations, width 20 mm	77
20 Fittings	For pneumatic supply plate	82
21 Supply plate	–	80
22 Electrical manifold module	For multi-pin plug connection, for AS-interface	79
23 Manifold block	For four valve locations, width 10 mm	77
24 Electrical interlinking module	For multi-pin plug connection, for AS-Interface, for a sub-base with pneumatic supply plate (on the left next to the sub-base)	79

# Valve terminals MPA-S

Peripherals overview

## Pneumatic components of the valve terminal – CPI connection, fieldbus

The manifold blocks are either prepared for:

- 2 or 4 single solenoid valves
- 2 or 4 double solenoid valves depending on the size.

- Double solenoid valve positions can be equipped with any valve or a blanking plate.
- Single solenoid valve positions can only be equipped with single solenoid valves.

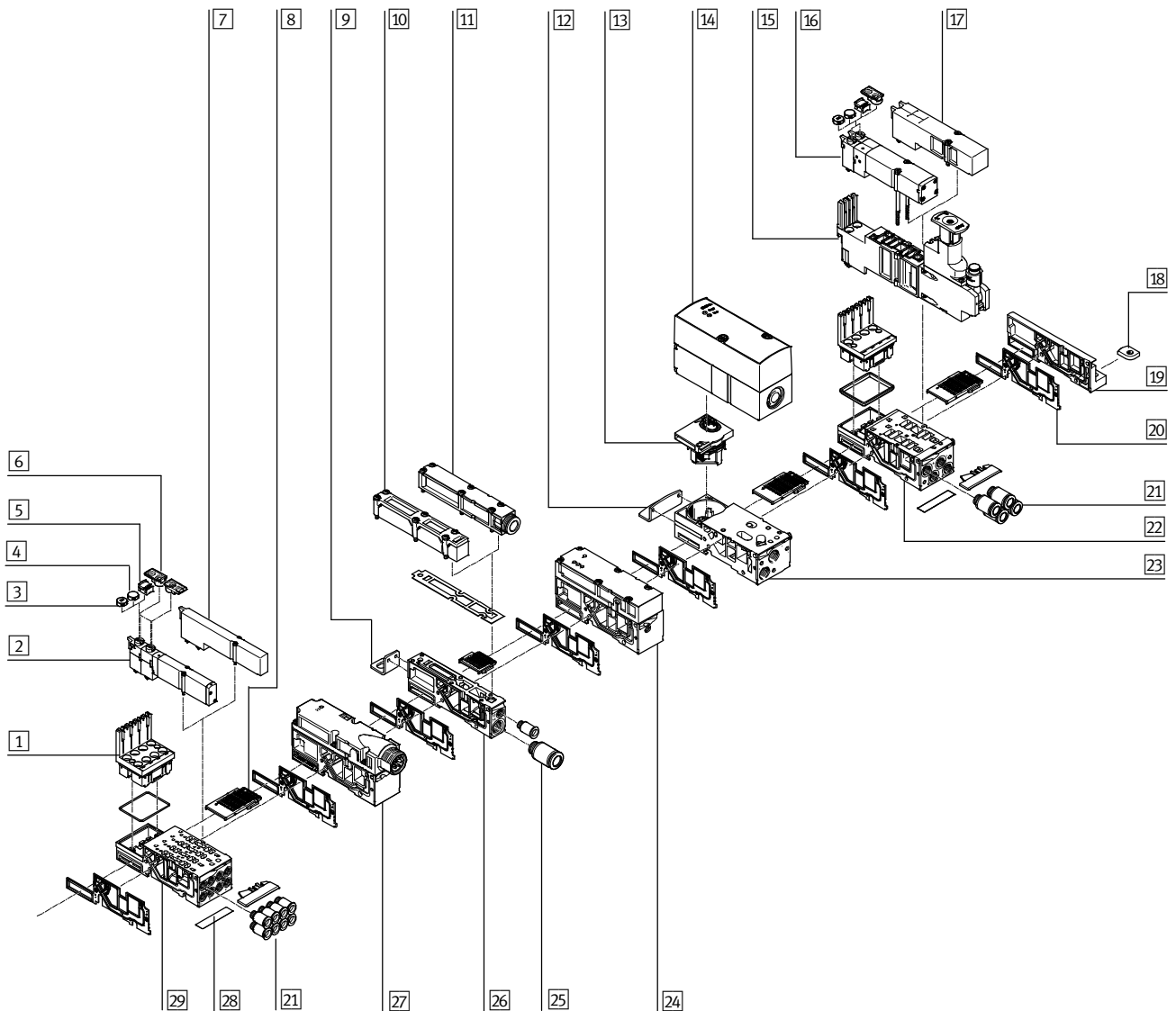

# Valve terminals MPA-S

Peripherals overview

Pneumatic components of the valve terminal – CPI connection, fieldbus		
Designation	Brief description	→ Page/Internet
1	Electronics module	–
2	Solenoid valve	Width 10 mm
3	Coded cover cap	Manual override with non-detenting operation only once cover cap fitted
4	Cover cap	Manual override blocked once cover cap fitted
5	Cover cap, manual override detenting	Manual override detenting and operable without tools once cover cap fitted
6	Inscription label holder	Can be pushed onto manual override
7	Blanking plate	For unused valve position (vacant position), width 10 mm
8	Electrical manifold module	For fieldbus connection, for proportional pressure regulator
9	Mounting	Optional for valve terminal mounting (on supply plate)
10	Flat plate silencer	–
11	Exhaust plate	For ducted exhaust air
12	Mounting	Optional for valve terminal mounting (on the manifold block of the proportional pressure regulator)
13	Electrical module	For proportional pressure regulator
14	Proportional pressure regulator	–
15	Regulator plate	Vertical stacking (pressure regulator plate, vertical pressure shut-off plate, vertical supply plate)
16	Solenoid valve	Width 20 mm
17	Blanking plate	For unused valve position (vacant position), width 20 mm
18	H-rail mounting	–
19	Right-hand end plate	–
20	Separating seal	For manifold block
21	Fittings	For working lines
22	Manifold block	For two valve locations, width 20 mm
23	Manifold block	For proportional pressure regulator
24	Pressure sensor	–
25	Fittings	For pneumatic supply plate
26	Supply plate	–
27	Electrical supply plate	For auxiliary voltage supply for large valve terminals
28	Inscription label	–
29	Manifold block	For four valve locations, width 10 mm

# Valve terminals MPA-S

Peripherals overview

## Valve terminal with multi-pin plug connection

Order code:

- 32P-... for the pneumatic components
- 32E-... for the electrical components

MPA valve terminals with multi-pin plug connection can be expanded by up to 24 solenoid coils.

The multi-pin plug connection is designed as a removable 25-pin Sub-D connection to IP65.

The cable can be selected when ordering:

- 2.5 m
- 5 m
- 10 m

Each can be used for max. 8 or 24 valves.

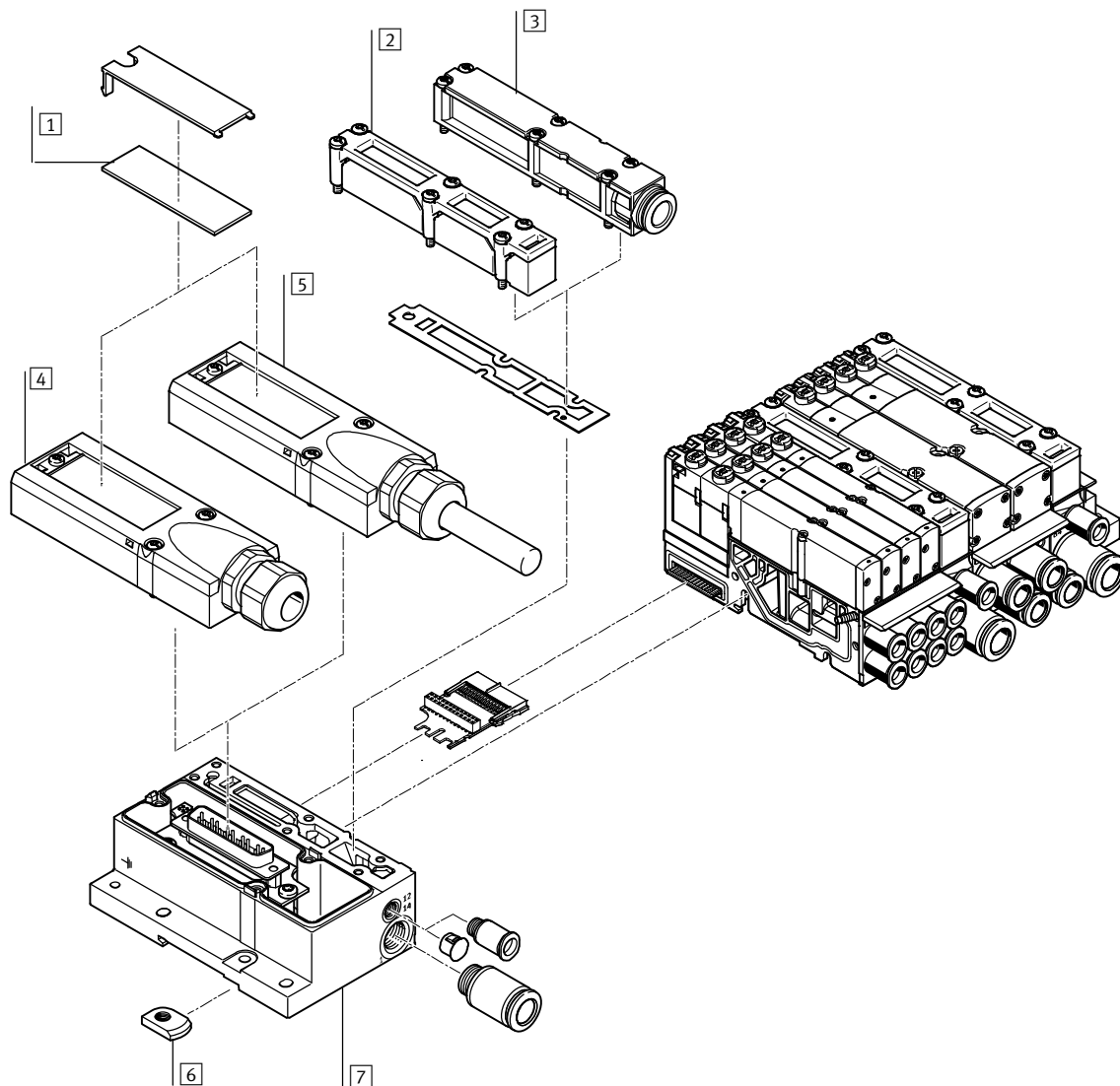

Designation	Brief description	→ Page/Internet
1 Inscription labels	Large, for multi-pin plug connection	-
2 Flat plate silencer	For pneumatic interface	-
3 Exhaust plate	For ducted exhaust air	80
4 Multi-pin plug connection	For self-assembly	81
5 Multi-pin plug connection	With multi-pin cable	81
6 H-rail mounting	-	83
7 Electrical interface	For multi-pin plug	78

# Valve terminals MPA-S

Peripherals overview

## Valve terminal with AS-interface connection

Order code:

- 32P-... for the pneumatic components
- 52E-... for the electrical components

MPA valve terminals with AS-interface connection can be expanded by up to 8 solenoid coils.

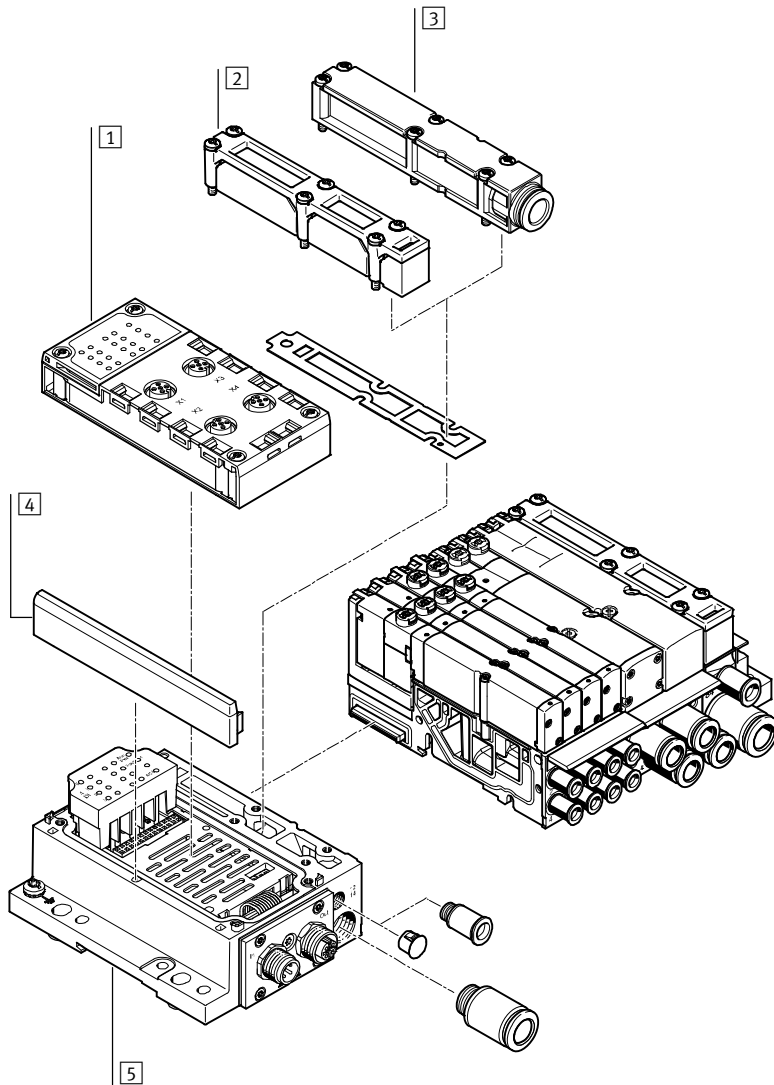

Designation	Brief description	→ Page/Internet
1 Manifold block	–	78
2 Flat plate silencer	For pneumatic interface	–
3 Exhaust plate	For ducted exhaust air	80
4 Cover	–	–
5 Electrical interface	–	78

# Valve terminals MPA-S

Peripherals overview

## Valve terminal with CPI connection

Order code:

- 32P-... for the pneumatic components
- 56E-... for the electrical components

MPA valve terminals with CPI connection can be expanded by up to 32 solenoid coils.

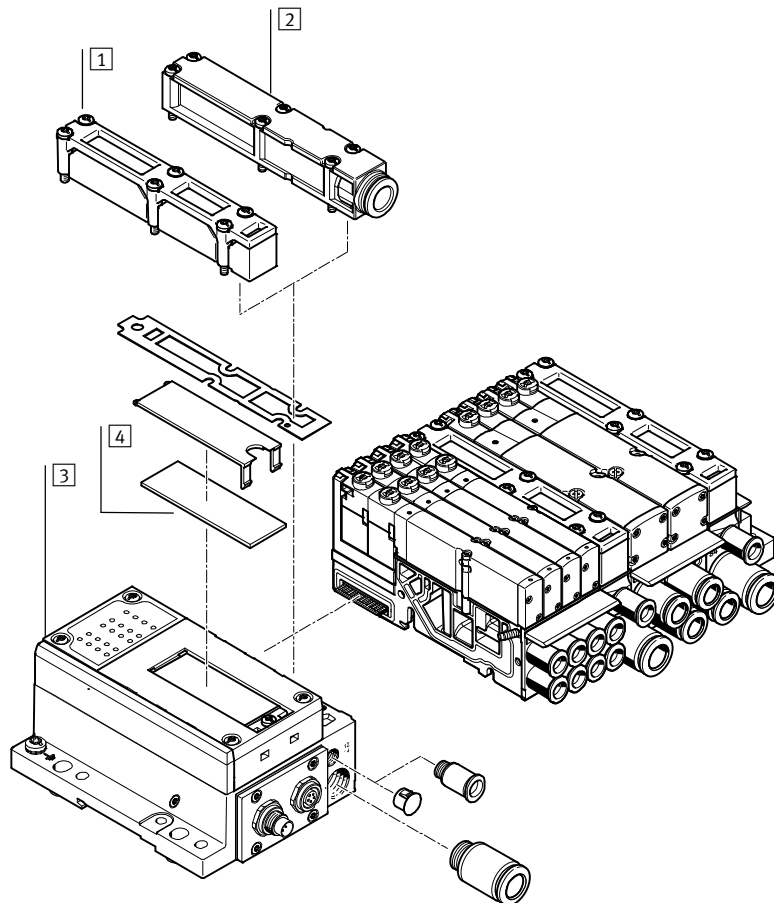

Designation	Brief description	→ Page/Internet
1 Flat plate silencer	For pneumatic interface	-
2 Exhaust plate	For ducted exhaust air	80
3 Electrical interface	-	78
4 Inscription label	Large for CPI electrical interface	-

# Valve terminals MPA-S

Peripherals overview

## Valve terminal with fieldbus connection, control block (electrical peripherals CPX)

Order code:

- 32P-... for the pneumatic components
- 50E-... for the electrical components

Valve terminals with fieldbus interfaces can be configured with up to 16 manifold blocks. In conjunction with MPA1 and 8 solenoid coils per manifold block, up to 128 solenoid coils can thus be equipped. An MPA2 with 4 solenoid coils per manifold block can actuate 64 solenoid coils.

Each valve position can be equipped with any valve or a blanking plate. The rules for CPX apply to the equipment that can be used in combination with the electrical peripherals CPX.  
In general:

- Digital inputs/outputs
- Analogue inputs/outputs
- Parameterisation of inputs and outputs
- Integrated multi-featured diagnostic system
- Preventive maintenance concepts

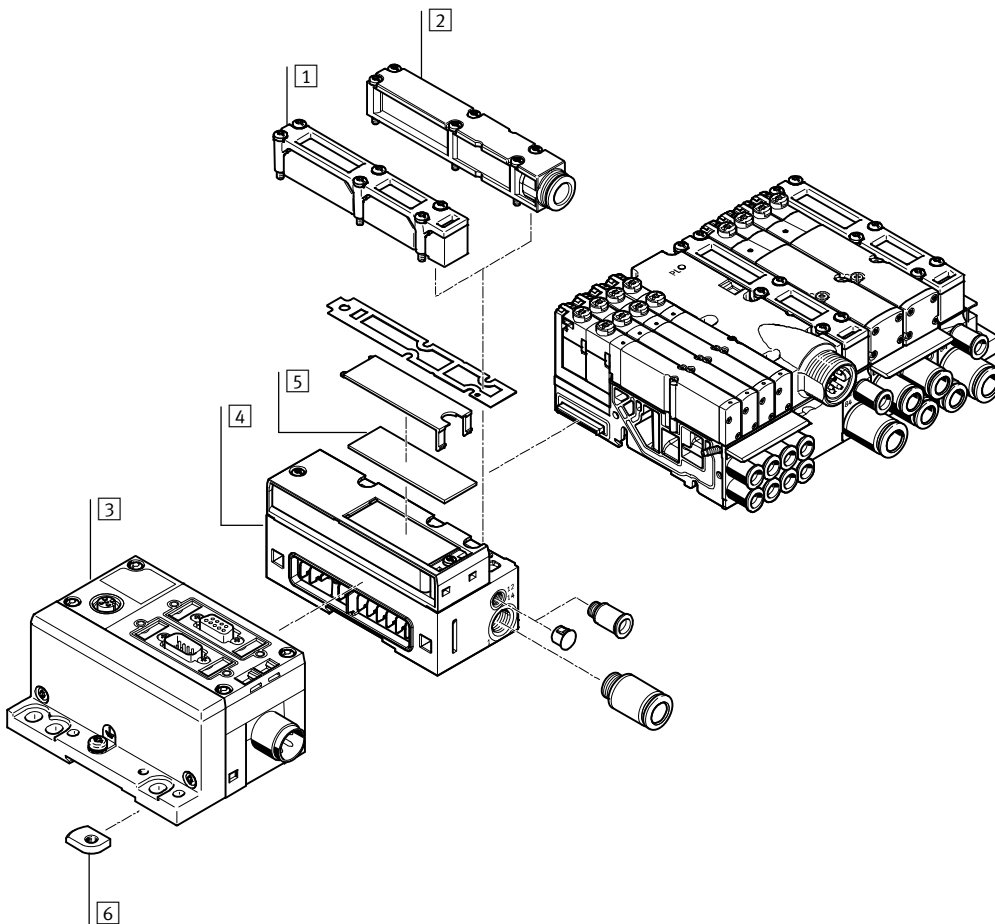

Designation	Brief description	→ Page/Internet
1 Flat plate silencer	For pneumatic interface	-
2 Exhaust plate	For ducted exhaust air	80
3 CPX modules	-	-
4 Pneumatic interface	For CPX modules	78
5 Inscription label	Large, for pneumatic interface CPX	-
6 H-rail mounting	-	83



# Valve terminals MPA-S

Key features – Pneumatic components

## Sub-base valve

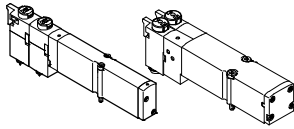

MPA offers a comprehensive range of valve functions. All valves are equipped with patented sealing system which facilitates efficient sealing, a broad pressure range and long service life. To increase power they have a pneumatic pilot control supplied by pilot air.

Sub-base valves can be quickly replaced since the tubing connectors remain on the manifold block. This design is also particularly flat.

Irrespective of the valve function there are sub-base valves with one solenoid coil (single solenoid) or with two solenoid coils (double solenoid or two single solenoid valves in one housing).

## Constructional design

### Valve replacement

The valves are attached to the metal manifold block using two screws, which means that they can be easily

replaced. The mechanical sturdiness of the manifold block guarantees excellent long-term sealing.

### Extension

Blanking plates can be replaced by valves at a later date. The dimensions, mounting points and existing pneumatic installations remain unchanged during this process.

The valve code (M, MS, MU, J, N, NS, NU, K, KS, KU, H, HS, HU, B, G, E, X, W, D, DS, I) is located on the front of the valve beneath the manual override.

5/2-way valve			
Code	Circuit symbol	Width [mm]	Description
M		10, 20	<ul style="list-style-type: none"> <li>• Single solenoid</li> <li>• Pneumatic spring return</li> <li>• Reverse operation</li> <li>• Operating pressure -0.9 ... +10 bar</li> </ul>
MS		10, 20	<ul style="list-style-type: none"> <li>• Single solenoid</li> <li>• Mechanical spring return</li> <li>• Reverse operation</li> <li>• Operating pressure -0.9 ... +8 bar</li> </ul>
MU		10	<ul style="list-style-type: none"> <li>• Single solenoid</li> <li>• Polymer poppet valve</li> <li>• Mechanical spring return</li> <li>• Reverse operation</li> <li>• Operating pressure -0.9 ... +10 bar</li> </ul>
J		10, 20	<ul style="list-style-type: none"> <li>• Double solenoid</li> <li>• Reverse operation</li> <li>• Operating pressure -0.9 ... +10 bar</li> </ul>

# Valve terminals MPA-S

Key features – Pneumatic components



2x 3/2-way valve			
Code	Circuit symbol	Width [mm]	Description
N		10, 20	<ul style="list-style-type: none"> <li>• Single solenoid</li> <li>• Normally open</li> <li>• Pneumatic spring return</li> <li>• Operating pressure 3 ... 10 bar</li> </ul>
NS		10, 20	<ul style="list-style-type: none"> <li>• Single solenoid</li> <li>• Normally open</li> <li>• Mechanical spring return</li> <li>• Reverse operation</li> <li>• Operating pressure -0.9 ... +8 bar</li> </ul>
NU		10	<ul style="list-style-type: none"> <li>• Single solenoid</li> <li>• Polymer poppet valve</li> <li>• Normally open</li> <li>• Mechanical spring return</li> <li>• Reverse operation</li> <li>• Operating pressure -0.9 ... +10 bar</li> </ul>
K		10, 20	<ul style="list-style-type: none"> <li>• Single solenoid</li> <li>• Normally closed</li> <li>• Pneumatic spring return</li> <li>• Operating pressure 3 ... 10 bar</li> </ul>
KS		10, 20	<ul style="list-style-type: none"> <li>• Single solenoid</li> <li>• Normally closed</li> <li>• Mechanical spring return</li> <li>• Reverse operation</li> <li>• Operating pressure -0.9 ... +8 bar</li> </ul>
KU		10	<ul style="list-style-type: none"> <li>• Single solenoid</li> <li>• Polymer poppet valve</li> <li>• Normally closed</li> <li>• Mechanical spring return</li> <li>• Reverse operation</li> <li>• Operating pressure -0.9 ... +10 bar</li> </ul>
H		10, 20	<ul style="list-style-type: none"> <li>• Single solenoid</li> <li>• Normal position                             <ul style="list-style-type: none"> <li>- 1x closed</li> <li>- 1x open</li> </ul> </li> <li>• Pneumatic spring return</li> <li>• Operating pressure 3 ... 10 bar</li> </ul>
HS		10, 20	<ul style="list-style-type: none"> <li>• Single solenoid</li> <li>• Normal position                             <ul style="list-style-type: none"> <li>- 1x closed</li> <li>- 1x open</li> </ul> </li> <li>• Mechanical spring return</li> <li>• Reverse operation</li> <li>• Operating pressure -0.9 ... +8 bar</li> </ul>
HU		10	<ul style="list-style-type: none"> <li>• Single solenoid</li> <li>• Polymer poppet valve</li> <li>• Normal position                             <ul style="list-style-type: none"> <li>- 1x closed</li> <li>- 1x open</li> </ul> </li> <li>• Mechanical spring return</li> <li>• Reverse operation</li> <li>• Operating pressure -0.9 ... +10 bar</li> </ul>

# Valve terminals MPA-S

Key features – Pneumatic components

5/3-way valve			
Code	Circuit symbol	Width [mm]	Description
B		10, 20	<ul style="list-style-type: none"> <li>• Mid-position pressurised<sup>1)</sup></li> <li>• Mechanical spring return</li> <li>• Reverse operation</li> <li>• Operating pressure –0.9 ... +10 bar</li> </ul>
G		10, 20	<ul style="list-style-type: none"> <li>• Mid-position closed<sup>1)</sup></li> <li>• Mechanical spring return</li> <li>• Reverse operation</li> <li>• Operating pressure –0.9 ... +10 bar</li> </ul>
E		10, 20	<ul style="list-style-type: none"> <li>• Mid-position exhausted<sup>1)</sup></li> <li>• Mechanical spring return</li> <li>• Reverse operation</li> <li>• Operating pressure –0.9 ... +10 bar</li> </ul>

1) If neither solenoid coil is energised, the valve moves to its mid-position by means of spring force.  
If both coils are energised at the same time, the valve remains in the previously assumed switching position.

3/2-way valve			
Code	Circuit symbol	Width [mm]	Description
W		10, 20	<ul style="list-style-type: none"> <li>• Single solenoid</li> <li>• Normally open</li> <li>• External compressed air supply</li> <li>• Pneumatic spring return</li> <li>• Reverse operation</li> <li>• Operating pressure –0.9 ... +10 bar</li> </ul> <p>Compressed air (–0.9 ... +10 bar) supplied at working port 2 can be switched with both internal and external pilot air supply.</p>
X		10, 20	<ul style="list-style-type: none"> <li>• Single solenoid</li> <li>• Normally closed</li> <li>• External compressed air supply</li> <li>• Pneumatic spring return</li> <li>• Reverse operation</li> <li>• Operating pressure –0.9 ... +10 bar</li> </ul> <p>Compressed air (–0.9 ... +10 bar) supplied at working port 4 can be switched with both internal and external pilot air supply.</p>

# Valve terminals MPA-S

Key features – Pneumatic components

2x 2/2-way valve			
Code	Circuit symbol	Width [mm]	Description
D		10, 20	<ul style="list-style-type: none"> <li>• Single solenoid</li> <li>• Normally closed</li> <li>• Pneumatic spring return</li> <li>• Operating pressure 3 ... 10 bar</li> </ul>
DS		10, 20	<ul style="list-style-type: none"> <li>• Single solenoid</li> <li>• Normally closed</li> <li>• Mechanical spring return</li> <li>• Reverse operation</li> <li>• Operating pressure -0.9 ... +8 bar</li> </ul>
I		10, 20	<ul style="list-style-type: none"> <li>• Single solenoid</li> <li>• 1x normally closed</li> <li>• 1x normally closed, reverse operation</li> <li>• Pneumatic spring return</li> <li>• Operating pressure 3 ... 10 bar</li> <li>• Vacuum at port 3/5 only</li> </ul>

- - Note

A filter must be installed upstream of valves operated in vacuum mode. This prevents any foreign matter in the intake air getting into the valve (e.g. when operating a suction cup).

# Valve terminals MPA-S

Key features – Pneumatic components

## Vertical stacking

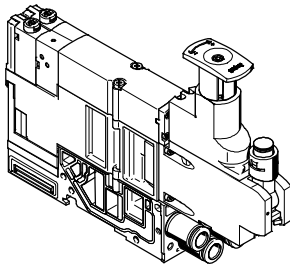

Additional function units can be added to each valve position between the sub-base and the valve.

These functions are known as vertical stacking, and enable special function-

ing or control of an individual valve position.

## Pressure regulator plate

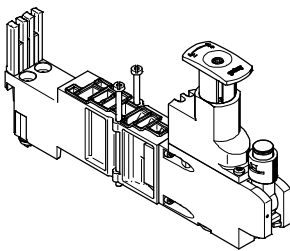

An adjustable pressure regulator can be installed between the sub-base and the valve in order to control the force of the triggered actuator.

This pressure regulator maintains an essentially constant output pressure (secondary side) independent of pressure fluctuations (primary side) and air consumption.

Standard version:

- For regulating range up to 6 bar or up to 10 bar
- Without pressure gauge (optional, rotatable, M5 connection with MPA1, cartridge connection with MPA2)
- MPA2: Regulator head with 3 positions (locked, reference position, idle running)
- MPA1: Set using screwdriver

## Vertical pressure shut-off plate for MPA1

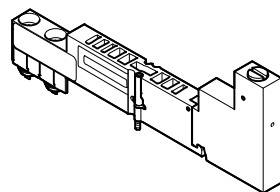

The vertical pressure shut-off plate can be used to hot swap individual valves without switching off the overall air supply.

The working pressure for the individual valve can be switched off manually via the vertical pressure shut-off plate using the actuating element.

## New Non-return valve

### Valve terminals MPA-S

Key features – Pneumatic components

FESTO

#### Vertical stacking

Vertical pressure supply plate for MPA2

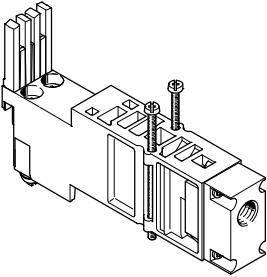

This vertical pressure supply plate enables an individual valve to be supplied with individual operating pressure independently of the operating pressure of the valve terminal.

The exhaust and pilot air supply of the valve are still provided via the central connections of the valve terminal.

#### Non-return valve

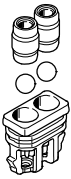

The non-return valves prevent the air (back pressure) from exhaust ducts 3 and 5 from entering the solenoid valve, thereby preventing the back pressure from having a disruptive effect on other connected actuators. The non-return valves are integrated into ducts 3 and 5 of the sub-bases designed specifically for this purpose.

Please see the relevant assembly instructions:

→ [www.festo.com/sp](http://www.festo.com/sp)

This function makes it possible to effectively protect single-acting process valves from the effects of back pressure.

This ensures reliable and feedback-free switching operations, especially in the case of rapid switching operations.

 Note

- Special sub-bases are available for use with non-return valves.
- Standard sub-bases cannot be retrofitted with non-return valves.
- Pre-assembled sub-bases with integrated non-return valves are available.
- It is not possible to use a non-return valve and a fixed restrictor (in the same duct) at the same time.

# Valve terminals MPA-S

Key features – Pneumatic components

## Vertical stacking

### Vertical stacking components, MPA1

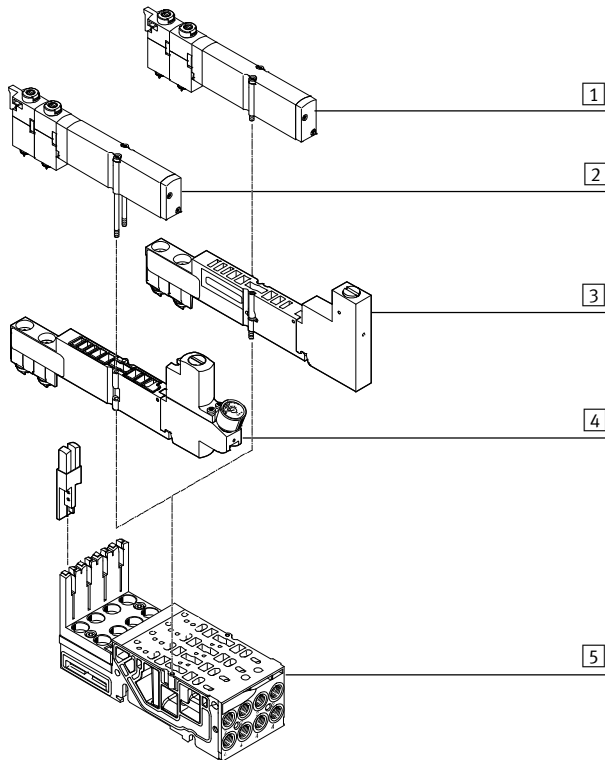

- 1 Valve VMPA1
- 2 Valve VMPA1, mounting screws replaced by long version (included in the scope of delivery of the regulator plate)
- 3 Vertical pressure shut-off plate VMPA1-HS
- 4 Regulator plate VMPA1
- 5 Manifold sub-base

### Vertical stacking components, MPA2

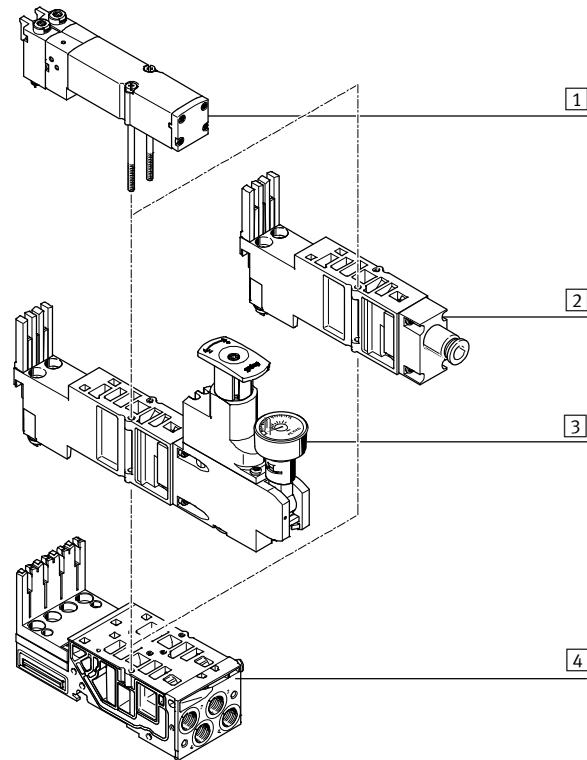

- 1 Valve VMPA2
- 2 Vertical pressure supply plate
- 3 Regulator plate VMPA2
- 4 Manifold sub-base

### Fixed restrictor for manifold sub-bases MPA1

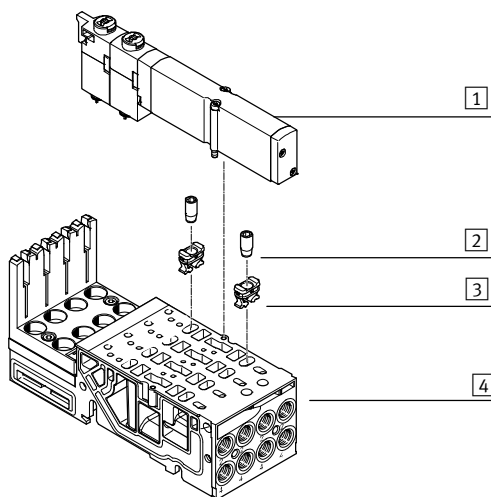

- 1 Valve VMPA1
- 2 Fixed restrictor
- 3 Retainer
- 4 Manifold sub-base

The fixed restrictor can be used to permanently set the flow rate in ducts 3 and 5 when exhausting air. To be able to screw the restrictor into the sub-base, the retainer is first pressed as far as it will go into the exhaust

The fixed restrictor can then be screwed in until it is flush with the top of the retainer. The restrictor screw cuts a thread into the retainer as it is screwed in. As the restrictor is being screwed in, two hooks on the underside of the retainer also deform to additionally anchor the retainer in the sub-base.

 **New**  
**Non-return valve**

## Valve terminals MPA-S

Key features – Pneumatic components

**FESTO**

### Vertical stacking

Non-return valve

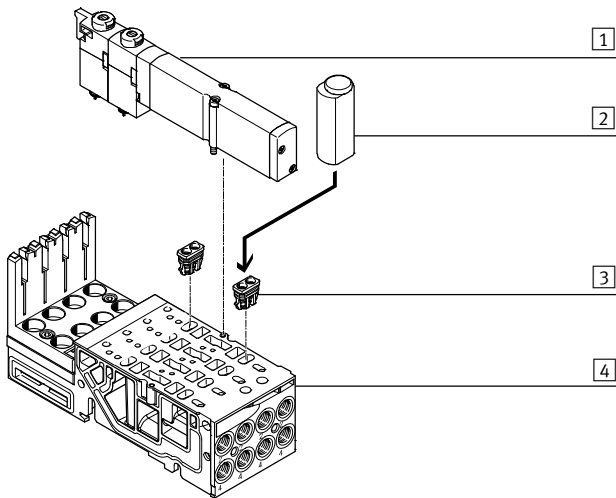

- 1 VMPA1 valve
- 2 Assembly tool
- 3 Non-return valve
- 4 Sub-base

Festo non-return valves can only be used in combination with the sub-bases designed specifically for this purpose.

The non-return valves should be installed according to the specifications using the enclosed assembly tool. Following assembly, the non-return valves cannot be removed.

Please see the relevant assembly instructions:

➔ [www.festo.com/sp](http://www.festo.com/sp)

For widths 10 mm and 20 mm there are special sub-bases available that facilitate the installation of non-return valves.

#### Note

- Special sub-bases are available for use with non-return valves.
- Standard sub-bases cannot be retrofitted with non-return valves.
- Pre-assembled sub-bases with integrated non-return valves are available.
- It is not possible to use a non-return valve and a fixed restrictor (in the same duct) at the same time.



# Valve terminals MPA-S

Key features – Pneumatic components

## Vertical stacking

Mode of operation of the pressure regulator plate (P regulator) for port 1; code: PA, PF

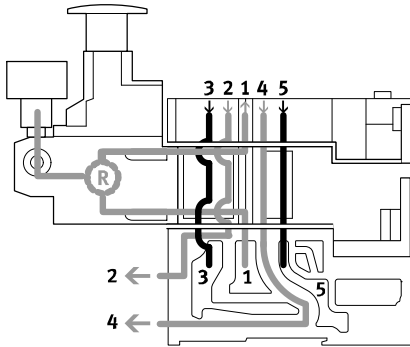

This pressure regulator regulates the pressure upstream of the valve in duct 1. Ducts 2 and 4 thus have the same regulated pressure.

During venting, the exhaust flow in the valve is from duct 2 to duct 3 and from duct 4 to duct 5.

## Advantages

- The pressure regulator is not affected by venting, since the pressure is regulated upstream of the valve.
- The pressure regulator can always be adjusted, since the pressure from the valve terminal is always present.

## Application examples

- An equal working pressure is required at working ports 2 and 4.
- A lower working pressure (e.g. 3 bar) than the operating pressure present at the valve terminal (e.g. 8 bar) is required.

Mode of operation of the pressure regulator plate (B regulator) for port 2; code: PC, PH

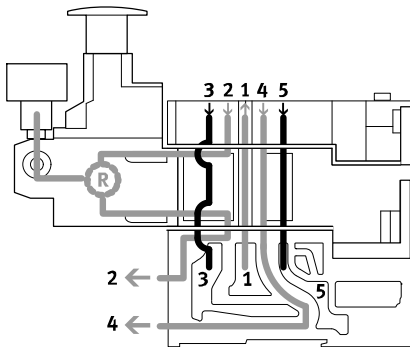

This pressure regulator regulates the pressure in duct 2 after the pressure medium flows through the valve. During venting, the exhaust flow in the valve is from duct 2 to duct 3 via the pressure regulator.

## Restrictions

The pressure regulator can only be adjusted in switched state (e.g. the valve is switched to 2 and exhaust flow occurs from 4 to 5).

## Application example

The pressure regulator makes it possible to reduce the pressure at port 2 of an individual valve, in contrast to the operating pressure of the valve terminal.

# Valve terminals MPA-S

Key features – Pneumatic components

## Vertical stacking

Mode of operation of the pressure regulator plate (A regulator) for port 4; code: PB, PK

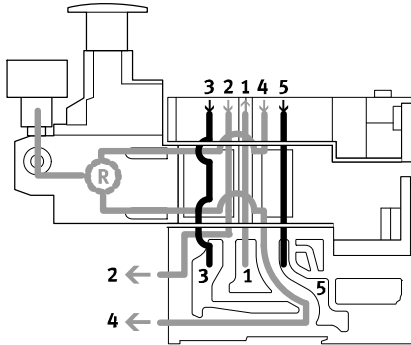

This pressure regulator regulates the pressure in duct 4 after the pressure medium flows through the valve. During venting, the exhaust flow in the valve is from duct 4 to duct 5 via the pressure regulator.

## Restrictions

The pressure regulator can only be adjusted in switched state (e.g. the valve is switched to 4 and exhaust flow occurs from 2 to 3).

## Application example

If different working pressures are required at ports 4 and 2. The pressure present at port 2 is from duct 1.

Mode of operation of the pressure regulator plate (B regulator, reversible) for port 2, reversible; code: PL, PN

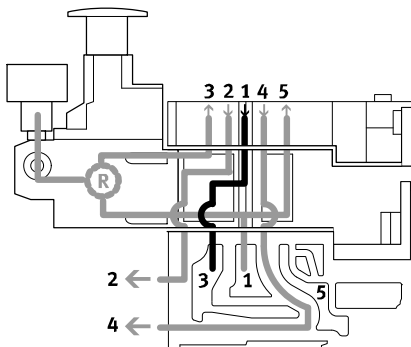

The reversible B regulator splits the supply air in duct 1 and regulates the pressure upstream of the valve in duct 3 (the unregulated pressure from duct 1 is in duct 5). The regulated air is then supplied to duct 2. The valve is thus operated in reversible mode.

During venting, the exhaust flow in the valve is from duct 2 to duct 1 and it is reversed into the manifold block via the intermediate plate to duct 3.

## Application examples

- When instead of the operating pressure of the valve terminal, a different pressure is required in duct 2.
- When fast exhaust venting is required.
- When the pressure regulator must always be adjustable.

Note

Reversible pressure regulator plates may only be combined with valves that can be operated in reversible mode.

## Advantages

- Fast cycle times.
- 50% higher exhaust flow rate, as air is not exhausted via the pressure regulator. The load on the pressure regulator is also reduced.
- No quick exhaust valves are required.
- Operating pressure is always present at the pressure regulator, as the pressure is regulated upstream of the valve, i.e. the regulator can always be adjusted.

## Restrictions

- 2x 3/2-way valves (code N, K, H) are not used, as pressure is present at ports 3 and 5.

# Valve terminals MPA-S

Key features – Pneumatic components

## Vertical stacking

Mode of operation of the pressure regulator plate (A regulator, reversible) for port 4, reversible; code: PK, PM

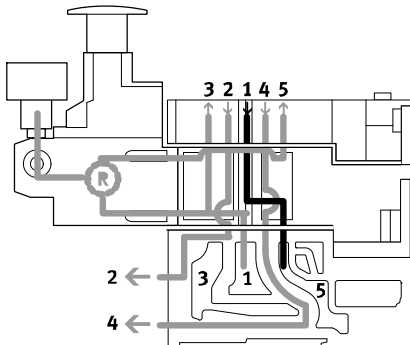

The reversible A regulator splits the working air in duct 1 and supplies the pressure upstream of the valve into duct 5 (the unregulated pressure from duct 1 is in duct 3). The regulated air is then supplied to duct 4. The valve is thus operated in reversible mode.

During venting, the exhaust flow in the valve is from duct 4 to duct 1 and it is reversed into the manifold block via the intermediate plate to duct 5.

## Application examples

- When instead of the operating pressure of the valve terminal, a different pressure is required in duct 4.
- When fast exhaust venting is required.
- When the pressure regulator must always be adjustable.

 Note  
Reversible pressure regulator plates may only be combined with valves that can be operated in reversible mode.

## Advantages

- Fast cycle times.
- 50% higher exhaust flow rate, as air is not exhausted via the pressure regulator. The load on the pressure regulator is also reduced.
- No quick exhaust valves are required.
- Operating pressure is always present at the pressure regulator, as the pressure is regulated upstream of the valve, i.e. the regulator can always be adjusted.

## Restrictions

- 2x 3/2-way valves (code N, K, H) are not used, as pressure is present at ports 3 and 5.

# Valve terminals MPA-S

Key features – Pneumatic components



Vertical stacking – Pressure regulator plate						
Code		Type	Width	Regulating range		Description
			[mm]	up to 6 bar	up to 10 bar	
Pressure regulator plate for port 1 (P regulator)						
PA		VMPA1-B8-R1-M5-10	10	-	■	Regulates the operating pressure in duct 1 upstream of the directional control valve
		VMPA1-B8-R1C2-C-10	10			
		VMPA2-B8-R1C2-C-10	20			
PF		VMPA1-B8-R1-M5-06	10			
		VMPA1-B8-R1C2-C-06	10	■	-	
		VMPA2-B8-R1C2-C-06	20			
Pressure regulator plate for port 2 (B regulator)						
PC		VMPA1-B8-R2-M5-10	10	-	■	Regulates the operating pressure in duct 2 downstream of the directional control valve
		VMPA1-B8-R2C2-C-10	10			
		VMPA2-B8-R2C2-C-10	20			
PH		VMPA1-B8-R2-M5-06	10			
		VMPA1-B8-R2C2-C-06	10	■	-	
		VMPA2-B8-R2C2-C-06	20			
Pressure regulator plate for port 4 (A regulator)						
PB		VMPA1-B8-R3-M5-10	10	-	■	Regulates the operating pressure in duct 4 downstream of the directional control valve
		VMPA1-B8-R3C2-C-10	10			
		VMPA2-B8-R3C2-C-10	20			
PG		VMPA1-B8-R3-M5-06	10			
		VMPA1-B8-R3C2-C-06	10	■	-	
		VMPA2-B8-R3C2-C-06	20			
Pressure regulator plate for port 2, reversible (B regulator)						
PL		VMPA2-B8-R6C2-C-10	20	-	■	Reversible pressure regulator to port 2
PN		VMPA2-B8-R6C2-C-06	20	■	-	
Pressure regulator plate for port 4, reversible (A regulator)						
PK		VMPA2-B8-R7C2-C-10	20	-	■	Reversible pressure regulator to port 4
PM		VMPA2-B8-R7C2-C-06	20	■	-	

# Valve terminals MPA-S

Key features – Pneumatic components

## Proportional pressure regulator

The purpose of the proportional pressure regulator VPPM-6TA-... is to regulate a pressure proportionally to a specified setpoint value. To this end, an integrated pressure sensor records the pressure at the working line and compares this value against

the setpoint value. If there is a deviation between the nominal and actual values, the valve regulates the output pressure until it reaches the setpoint value. The proportional pressure regulator has an additional supply connection to achieve the

constant pressure supply required for high control quality.

The proportional pressure regulator can be configured via the PLC or on-site via the handheld device (CPX-MMI) from Festo.



Note

Output pressure is maintained unregulated if the power supply cable is interrupted.

## Proportional pressure regulator

Graphical symbol	Code	Type	Full-scale linearity error [%]	Supply pressure 1 [bar]	Pressure regulation range [bar]
	QA	VPPM-6TA-L-1-F-0L2H	2	0 ... 4	0,02 ... 2
	QB	VPPM-6TA-L-1-F-0L6H	2	0 ... 8	0,06 ... 6
	QC	VPPM-6TA-L-1-F-0L10H	2	0 ... 11	0,1 ... 10
	QD	VPPM-6TA-L-1-F-0L2H-S1	1	0 ... 4	0,02 ... 2
	QE	VPPM-6TA-L-1-F-0L6H-S1	1	0 ... 8	0,06 ... 6
	QF	VPPM-6TA-L-1-F-0L10H-S1	1	0 ... 11	0,1 ... 10
	QG	VPPM-8TA-L-1-F-0L2H-C1	2	0 ... 4	0,02 ... 2
	QH	VPPM-8TA-L-1-F-0L6H-C1	2	0 ... 8	0,06 ... 6
	QK	VPPM-8TA-L-1-F-0L10H-C1	2	0 ... 11	0,1 ... 10
	QL	VPPM-8TA-L-1-F-0L2H-S1C1	1	0 ... 4	0,02 ... 2
	QM	VPPM-8TA-L-1-F-0L6H-S1C1	1	0 ... 8	0,06 ... 6
	QN	VPPM-8TA-L-1-F-0L10H-S1C1	1	0 ... 11	0,1 ... 10

# Valve terminals MPA-S

Key features – Pneumatic components

## Layout of a control circuit

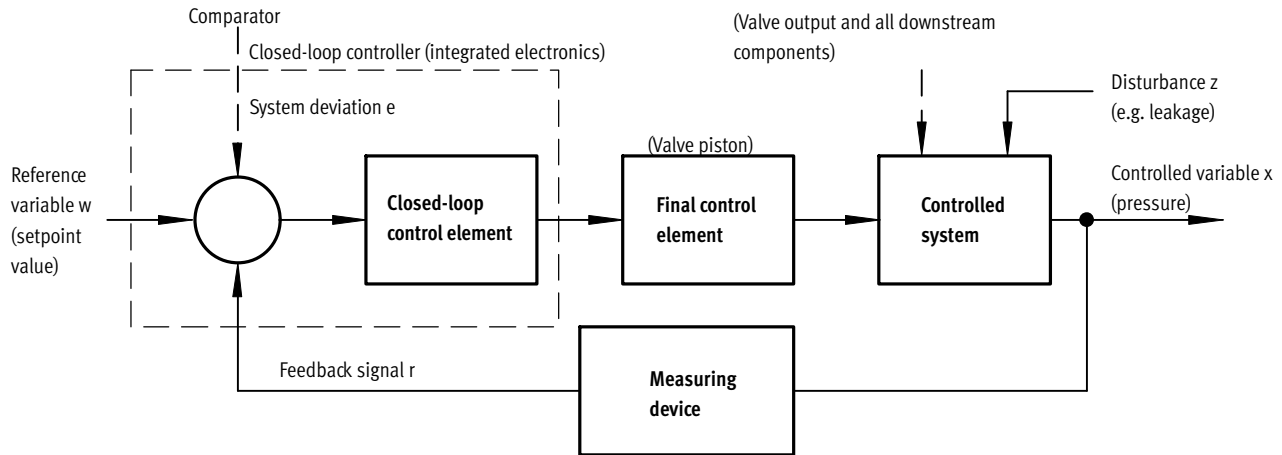

### Layout

The figure shows a closed-loop control circuit. The reference variable  $w$  initially acts on a comparator. The measuring device sends the value of the controlled variable  $x$  (actual value, e.g. 3 bar) to the comparator as a feedback signal  $r$ . The closed-loop control element detects the system deviation  $e$  and actuates the final control

element. The output of the final control element acts on the controlled system. The closed-loop control element thus attempts to compensate for the difference between the reference variable  $w$  and the controlled variable  $x$  by using the final control

### Method of operation

This process runs continuously so changes in the reference variable are always detected. However, a system deviation will also appear if the reference variable is constant but the controlled variable changes. This happens when the flow through the valve changes in response to a switching action, a cylinder movement or a change

in load. The disturbance variable  $z$  will also cause a system deviation. An example of this is when the pressure drops in the air supply. The disturbance variable  $z$  acts on the controlled variable  $x$  unintentionally. In all cases, the regulator attempts to readjust the controlled variable  $x$  to the reference variable  $w$ .

## Multi-sensor control (cascade control) of the VPPM

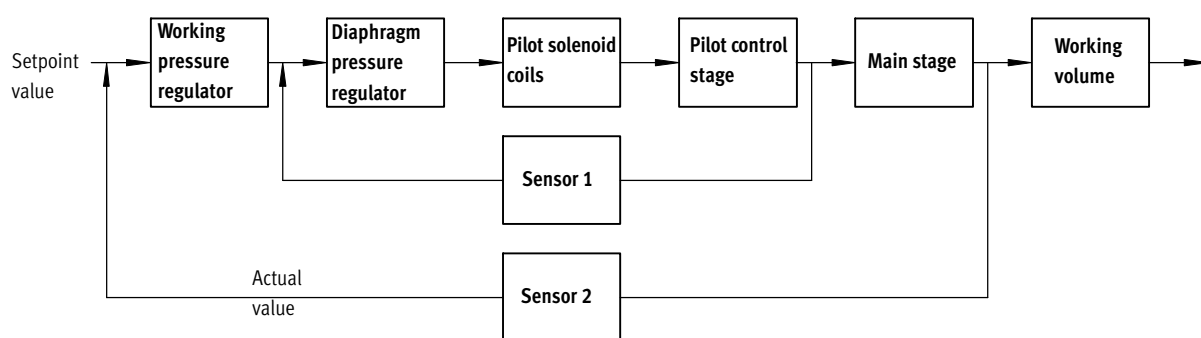

### Cascade control

Unlike conventional direct-acting regulators, with multi-sensor control several control circuits are nested inside each other. The overall controlled

system is divided into smaller sub-controlled circuits that are easier to control for the specific task.

### Control precision

Multi-sensor control significantly improves control precision and dynamic response in comparison with single-acting regulators.

# Valve terminals MPA-S

Key features – Pneumatic components

## Terms related to the proportional-pressure regulator

### Hysteresis

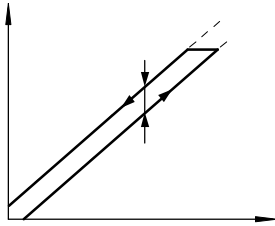

There is always a linear relationship within a certain tolerance between the setpoint value entered and the pressure output. Nevertheless it makes a difference whether the setpoint value is entered as rising or falling. The difference between the maximum deviations is referred to as hysteresis.

### Linearity error

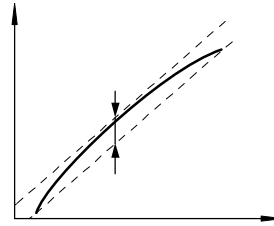

A perfectly linear progression of the control characteristic of the output pressure is theoretical. The maximum percentage deviation from this theoretical control characteristic is referred to as the linearity error. The percentage value refers to the maximum output pressure (full scale).

### Response sensitivity

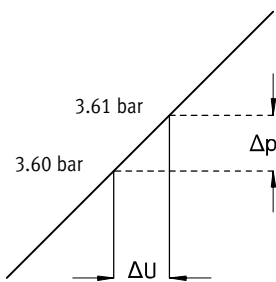

The response sensitivity of the device determines how sensitively one can change, i.e. adjust, a pressure. The smallest setpoint value difference that results in a change in the output pressure is referred to as the response sensitivity. In this case, 0.01 bar.

### Repetition accuracy (reproducibility)

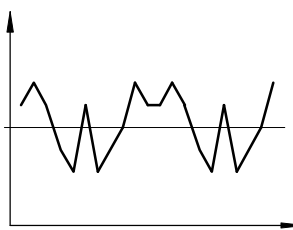

The repetition accuracy is the margin within which the fluid output variables are scattered when the same electrical input signal coming from the same direction is repeatedly adjusted. The repetition accuracy is expressed as a percentage of the maximum fluid output signal.

### Zero point suppression

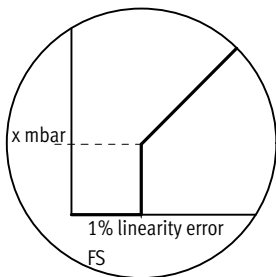

In practice there exists the possibility of residual voltage or residual current at the setpoint input of the VPPM via the setpoint generator. Zero point suppression is used so that the valve is reliably vented at a setpoint value of zero.

## Valve terminals MPA-S

Key features – Pneumatic components

### Blanking plate

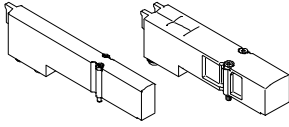

Plate without valve function for reserving valve positions on a valve terminal.

Valves and blanking plates are attached to the manifold block using two screws.

### Valve function

Code	Circuit symbol	Width	Description
		[mm]	
L	-	10	For valve terminal only: Blanking plate for vacant valve position
		20	

### Compressed air supply and exhaust

#### Pneumatics interface

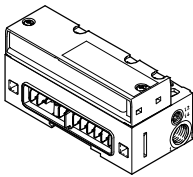

The valve terminal MPA can be supplied with air at one or more points. This ensures that the valve terminal will always have an adequate air supply and exhaust, even with large-scale expansions. The main supply to the valve terminal

is located on the pneumatics interface, which links the electrical and the pneumatic parts. Additional provision is made for a number of supply plates. Exhausting is either via integrated flat

plate silencers or common lines for ducted exhaust air. These exhausts are located on the pneumatic interface as well as on the supply plates and on the right-hand end plate (VMPA-ERP-G).

#### Supply plate

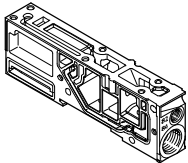

When there is a need for an increase in air supply, multiple supply plates can additionally be provided. Exhausting is either via integrated flat

plate silencers or common lines for ducted exhaust air. In the case of ducted exhaust air, at least one additional supply plate is

required, which is used to vent the exhaust air from the pilot air supply (port 82/84) (when using a right-hand end plate, without port 82/84).

#### Vertical pressure supply plate

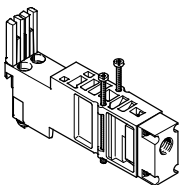

The individual compressed air supply of a single valve with a width of 20 mm can be realised using the vertical pressure supply plate VMPA2-VSP- ....

#### Right-hand end plate (VMPA-ERP-G)

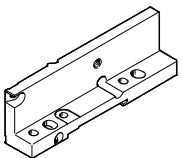

The air to be exhausted can be ducted using the right-hand end plate with port 82/84 (VMPA-ERP-G).

### Pilot air supply

The port for the main pneumatic supply is located on the pneumatic interface. The ports differ for the following types of pilot air supply:

- Internal
- External

#### Internal pilot air supply

Internal pilot air supply can be selected if the required working pressure is between 3 and 8 bar. The pilot air supply is then branched from the compressed air supply 1 in the pneumatic interface using an internal connection. Port 12/14 is sealed with a blanking plug.

#### External pilot air supply

If the supply pressure is less than 3 bar or greater than 8 bar, you must operate your MPA valve terminal with external pilot air supply. In this case the pilot air is additionally supplied via port 12/14 on the pneumatic interface.



#### Note

If a gradual pressure build-up in the system using a soft-start valve is chosen, an external pilot air supply should be connected so that the control pressure applied during switch-on is already very high.



## Valve terminals MPA-S

Key features – Pneumatic components

Compressed air supply and pilot air supply				
Code	Graphical symbol			Notes
	Type of compressed air supply and pilot air supply			
	Pneumatic interface	Supply plate	Right-hand end plate	
S				<p>Internal pilot air supply, flat plate silencer</p> <ul style="list-style-type: none"> <li>Pilot air supply is branched internally from port 1 in the pneumatic interface</li> <li>Exhaust port 3/5 and pilot exhaust port 82/84 via flat plate silencer</li> <li>For operating pressure in the range 3 ... 8 bar</li> </ul>
T				<p>External pilot air supply, flat plate silencer</p> <ul style="list-style-type: none"> <li>Pilot air supply between 3 and 8 bar is connected to port 12/14</li> <li>Exhaust port 3/5 and pilot exhaust port 82/84 via flat plate silencer</li> <li>For operating pressure in the range -0.9 ... 10 bar (suitable for vacuum)</li> </ul>
V				<p>Internal pilot air supply, ducted exhaust air</p> <ul style="list-style-type: none"> <li>Pilot air supply is branched internally from port 1 in the pneumatic interface</li> <li>Exhaust port 3/5: connection to pneumatic interface and supply plate</li> <li>Pilot exhaust port 82/84: connection to supply plate only</li> <li>For operating pressure in the range 3 ... 8 bar</li> </ul>
X				<p>External pilot air supply, ducted exhaust air</p> <ul style="list-style-type: none"> <li>Pilot air supply (3 ... 8 bar) is connected at port 12/14</li> <li>Exhaust port 3/5: connection to pneumatic interface and supply plate</li> <li>Pilot exhaust port 82/84: connection to supply plate only</li> <li>For operating pressure in the range -0.9 ... 10 bar (suitable for vacuum)</li> </ul>
Y				<p>Internal pilot air supply, ducted exhaust air via right-hand end plate</p> <ul style="list-style-type: none"> <li>Pilot air supply is branched internally from port 1 in the pneumatic interface</li> <li>Exhaust port 3/5: connection to pneumatic interface and supply plate</li> <li>Pilot exhaust air 82/84 ducted via right-hand end plate (VMPA-EPR-G)</li> <li>For operating pressure in the range 3 ... 8 bar</li> </ul>
Z				<p>External pilot air supply, ducted exhaust air via right-hand end plate</p> <ul style="list-style-type: none"> <li>Pilot air supply (3 ... 8 bar) is connected at port 12/14</li> <li>Exhaust port 3/5: connection to pneumatic interface and supply plate</li> <li>Pilot exhaust air 82/84 ducted via right-hand end plate (VMPA-EPR-G)</li> <li>For operating pressure in the range -0.9 ... 10 bar (suitable for vacuum)</li> </ul>

Pneumatic interface			
Code	Pneumatic interface design variants		Notes
	Graphical symbol	Type	
M		VMPA-...-EPL-...	<ul style="list-style-type: none"> <li>Used together with compressed air supply S, T, V, X</li> <li>The pilot exhaust air must be vented at least at one supply plate when using V or X. In the case of multiple supply plates, the port 82/84 is open on the last supply plate ex-works</li> </ul>

## Valve terminals MPA-S

Key features – Pneumatic components

### Supply plate

Additional supply plates can be used for larger terminals or to create additional pressure zones.

If several valves are to be operated simultaneously at full flow rate, it is recommended that a supply plate be positioned after every 8 valves (MPA1), or 4 valves (MPA2).

Supply plates can be configured at any point upstream or downstream of sub-bases. This applies to the following interfaces:

- MPA with CPX
- MPA with multi-pin plug connection
- MPA with AS-interface connection
- MPA with CPI connection

#### MPA with ducted exhaust air

When using a right-hand end plate without port 82/84, it is essential that a supply plate for ducted exhaust air is used. Alternatively, an end plate with port 82/84 (VMPA-EPR-G) can be used for ducted exhaust air. In this case, no supply plate is required.

Supply plates contain the following ports:

- Compressed air supply (1)
- Venting of the pilot air supply (82/84) and pressure compensation
- Exhaust air (3/5)

Depending on your order, the exhaust ducts are either ducted or vented via the flat plate silencer.

The supply plate is configured using the code letter U if no directly adjoining separating seal is required.

If a separating seal (S, T or R) is selected to the direct right or left of the supply plate, then the code letter V or W identifies the position of the left-hand or right-hand separating seal. The code for the separating seal (S, T or R) is placed in front of the code for the supply plate (V or W).

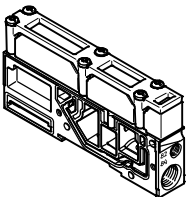
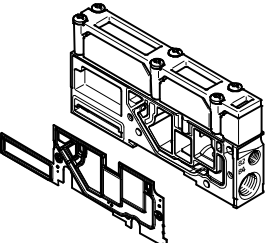
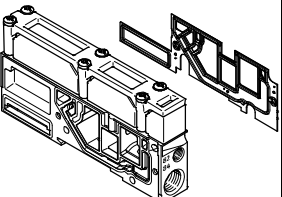
Supply plate			
Code <sup>1)</sup>	Graphical symbol	Type	Notes
U		VMPA1-...-SP...	Supply plate without separating seal (no R, S or T selected)
V		VMPA1-...-SP...	Supply plate with separating seal on left, if R, S or T selected
W		VMPA1-...-SP...	Supply plate with separating seal on right, if R, S or T selected

1) The supply plate is equipped with silencer or exhaust plate depending on the code for the air supply S, T, V, X.

# Valve terminals MPA-S

Key features – Electrical components

## Electrical supply plate

Additional electrical supply plates can be used for larger terminals. This enables up to 64 valve positions/128 solenoid coils to be supplied.

### MPA with CPX

Electrical supply plates can be configured at any point upstream or downstream of sub-bases. An electrical supply plate is required after 8 valve sub-bases.

### MPA with CPI connection

Electrical supply plates can be configured at any point upstream or downstream of manifold blocks. An electrical supply plate is required after 8 valve sub-bases.



Note

Please note that only electrical modules with isolated electrical circuits are permissible to the right of the electrical supply plate. The electrical supply plate must not be installed directly to the left of a pneumatic supply plate (type VMPA1-FB-SP..).



Note

Max. 24 of 32 MPA1 coils or 12 of 16 MPA2 coils can be switched on at the same time in the case of an MPA with CPI connection.

## Electrical supply plate

Code	Graphical symbol	Type	Notes
L		VMPA-FB-SP-V-SP	Electrical supply plate with M18 plug connection, 3-pin
		VMPA-FB-SP-7/8-V-5POL	Electrical supply plate with 7/8" plug connection, 5-pin
		VMPA-FB-SP-7/8-V-4POL	Electrical supply plate with 7/8" plug connection, 4-pin

## Pin allocation for power supply

	Pin	Allocation
Pin allocation for M18		
	2	24 V DC valves
	3	0 V DC
	4	FE
Pin allocation for 7/8", 5-pin		
	1	0 V DC valves
	2	n.c.
	3	FE (leading)
	4	n.c.
	5	24 V DC valves
Pin allocation for 7/8", 4-pin		
	A	n.c.
	B	24 V DC valves
	C	FE
	D	0 V DC valves (leading)

# Valve terminals MPA-S

Key features – Pneumatic components



## Creation of pressure zones and separation of exhaust air

If different work pressures are required, MPA offers various possibilities for building up pressure zones. Depending on the electrical interface up to 16 pressure zones are possible. A pressure zone is created by isolating the internal supply ducts between the manifold blocks using an appropriate separating seal or using a separator that is permanently integrated in the manifold block (code I or code III).

Compressed air is supplied and vented via a supply plate. The position of the supply plates and separating seals can be freely selected with the valve terminal MPA.

Separating seals are integrated ex-works as per your order. Separating seals can be distinguished through their coding, even when the valve terminal is assembled.

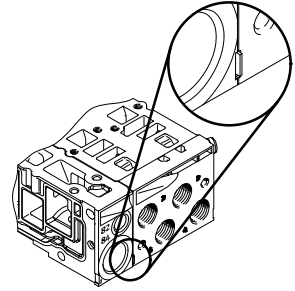









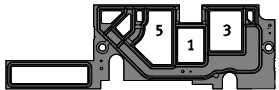

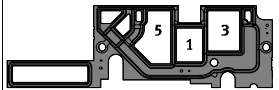

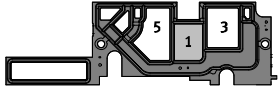

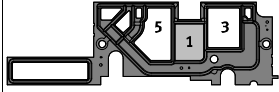

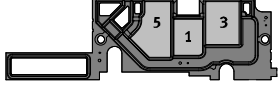
- - Note

The following must be taken into consideration for subsequent expansion or conversions:

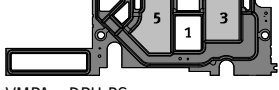
Different separating seals are required for operating with ducted exhaust air and operation with flat plate silencers.

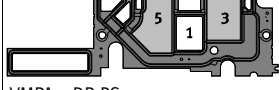
## Creating pressure zones

Code	Separating seal for operating with flat plate silencer		Separating seal for operating with ducted exhaust air		Notes
	Pictorial examples	Coding	Pictorial examples	Coding	
-	 VMPA...-DPU		 VMPA...-DP		No duct separation
T	 VMPA...-DPU-P		 VMPA...-DP-P		Duct 1 separate
S	 VMPA...-DPU-PRS		 VMPA...-DP-PRS		Duct 1 and 3/5 separate
R	 VMPA...-DPU-RS		 VMPA...-DP-RS		Duct 3/5 separate

# Valve terminals MPA-S

Key features – Pneumatic components

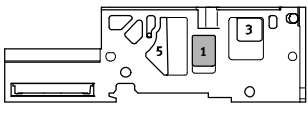
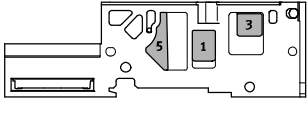
Creating pressure zones			
Code	Manifold block with duct separation for operating with flat plate silencer or with ducted exhaust air		Notes
	Pictorial examples	Coding	
I		-	Duct 1 separate
III		-	Duct 1 and 3/5 separate

-  - Note

The duct separation cannot be subsequently removed and is integrated in the centre of the manifold block:

- With width 10 mm between valves 2 and 3
- With width 20 mm between valves 1 and 2

# Valve terminals MPA-S

Key features – Pneumatic components

## Examples: Compressed air supply and pilot air supply

### Internal pilot air supply, flat plate silencer

Pneumatic air supply to the valve terminal: code S

The diagram opposite shows an example of the configuration and connection of the air supply with internal pilot air supply. Port 12/14 on the pneumatic interface or the electrical interface (multi-pin plug) as appropriate is tightly sealed. Ports 3/5 and 82/84 are vented via the flat plate silencers. Port 82/84 is tightly sealed. Separating seals can be used optionally to create pressure zones.

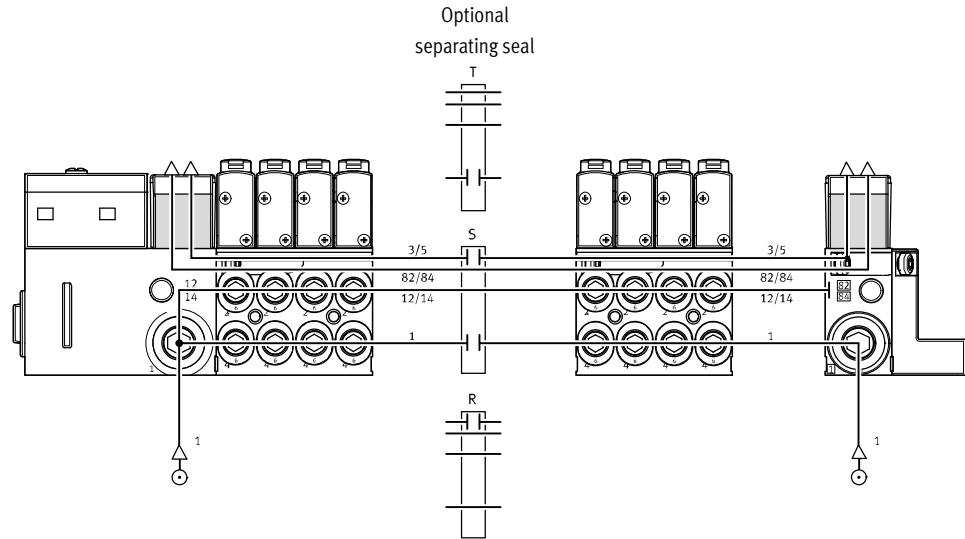

### External pilot air supply, flat plate silencer

Pneumatic air supply to the valve terminal: code T

The diagram opposite shows an example of the configuration and connection of the compressed air supply with external pilot air supply. Port 12/14 on the pneumatic interface or the electrical interface (multi-pin plug) as appropriate is equipped with a threaded connector for this purpose. Ports 3/5 and 82/84 are vented via the flat plate silencers. Port 82/84 is tightly sealed. Separating seals can be used optionally to create pressure zones.

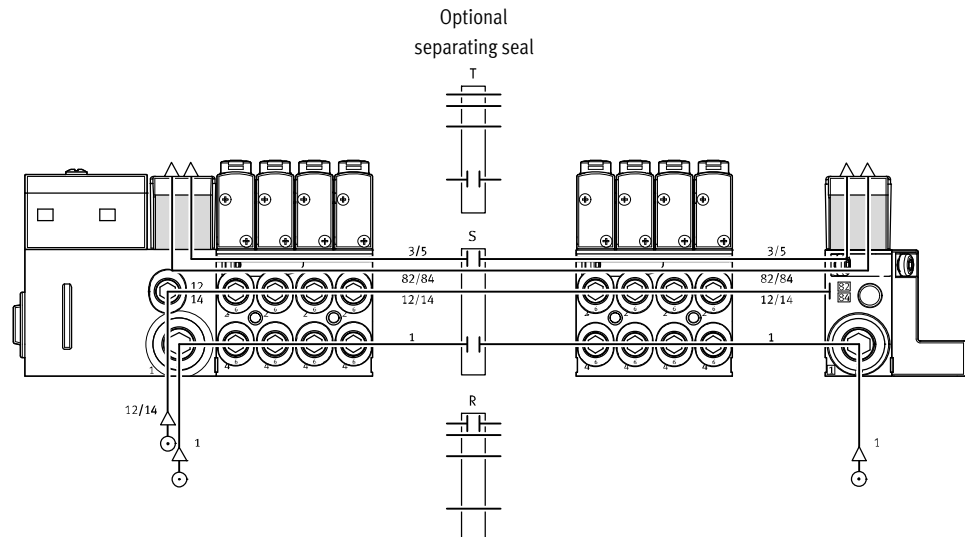

# Valve terminals MPA-S

Key features – Pneumatic components

## Examples: Compressed air supply and pilot air supply

### Internal pilot air supply, ducted exhaust air

Pneumatic air supply to the valve terminal: code V

The diagram opposite shows an example of the configuration and connection of the compressed air supply with internal pilot air supply. Port 12/14 on the pneumatic interface or the electrical interface (multi-pin plug) as appropriate is tightly sealed. Exhaust ports 3/5 and 82/84 are vented via the appropriate connections. Separating seals can be used optionally to create pressure zones.

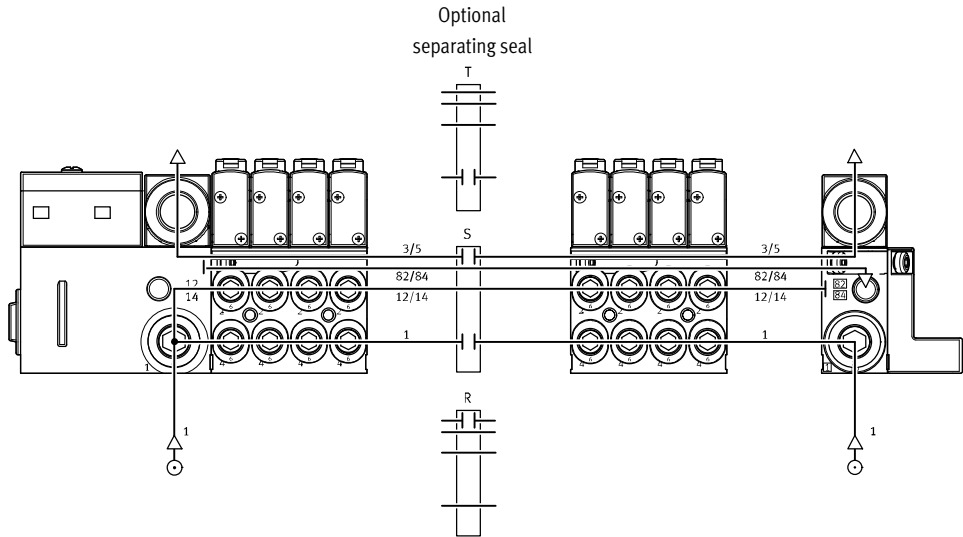

### External pilot air supply, ducted exhaust air

Pneumatic supply to the valve terminal: code X

The diagram opposite shows an example of the configuration and connection of the compressed air supply with external pilot air supply. Port 12/14 on the pneumatic interface or the electrical interface (multi-pin plug) as appropriate is equipped with a threaded connector for this purpose. Exhaust ports 3/5 and 82/84 are vented via the appropriate connections. Separating seals can be used optionally to create pressure zones.

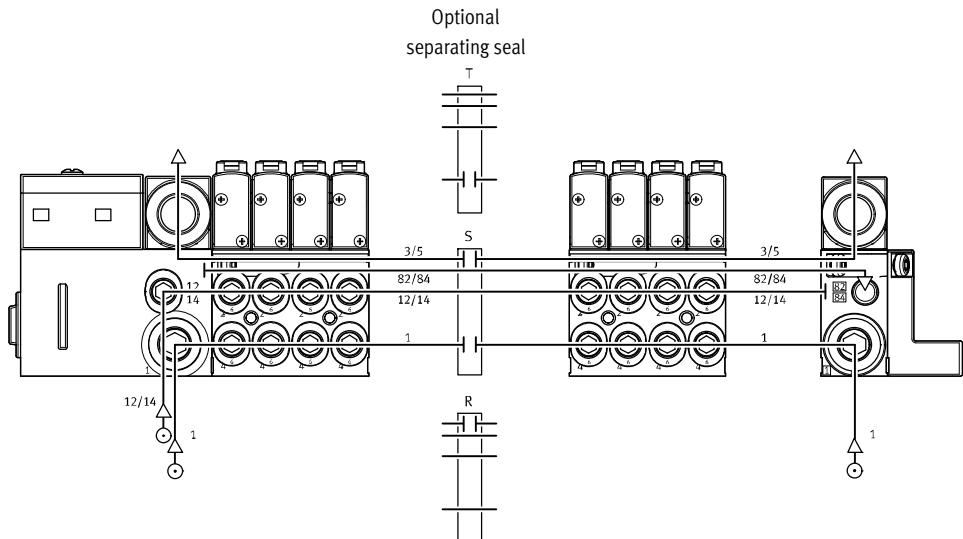

## Valve terminal MPA-S

Key features – Pneumatic components

### Examples: compressed air supply and pilot air supply

Internal pilot air supply, ducted exhaust air 82/84 via right-hand end plate

Pneumatic supply to the valve terminal: code Y

The illustration on the right shows an example of the configuration and connection of the compressed air supply in the case of internal pilot air supply. Port 12/14 on the pneumatic interface or the electrical interface (multi-pin plug) is tightly sealed. The exhaust port 3/5 is vented via the corresponding ports. The exhaust air from port 82/84 is ducted via the right-hand end plate via the right-hand end plate (VMPA-EPR-G). In this case, there is no need for a supply module for expelling the ducted exhaust air 82/84. Separating seals can be used optionally to create pressure zones.

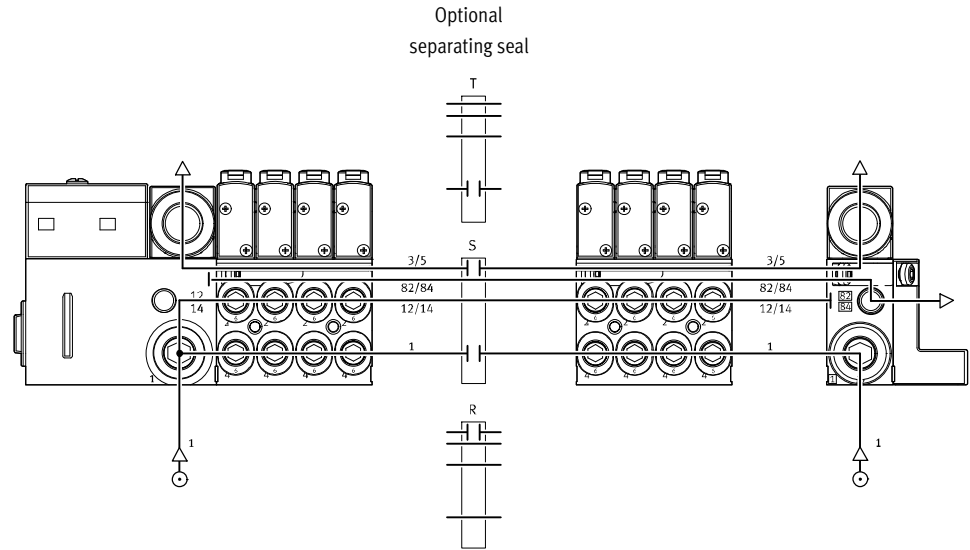

External pilot air supply, ducted exhaust air 82/84 via right-hand end plate

Pneumatic supply to the valve terminal: code Z

The illustration on the right shows an example of the configuration and connection of the compressed air supply in the case of external pilot air supply. Port 12/14 on the pneumatic interface or the electrical interface (multi-pin plug) is equipped with a threaded connector for this purpose. The exhaust port 3/5 is vented via the corresponding ports. The exhaust air from port 82/84 is ducted via the right-hand end plate via the right-hand end plate (VMPA-EPR-G). In this case, there is no need for a supply module for expelling the ducted exhaust air 82/84. Separating seals can be used optionally to create pressure zones.

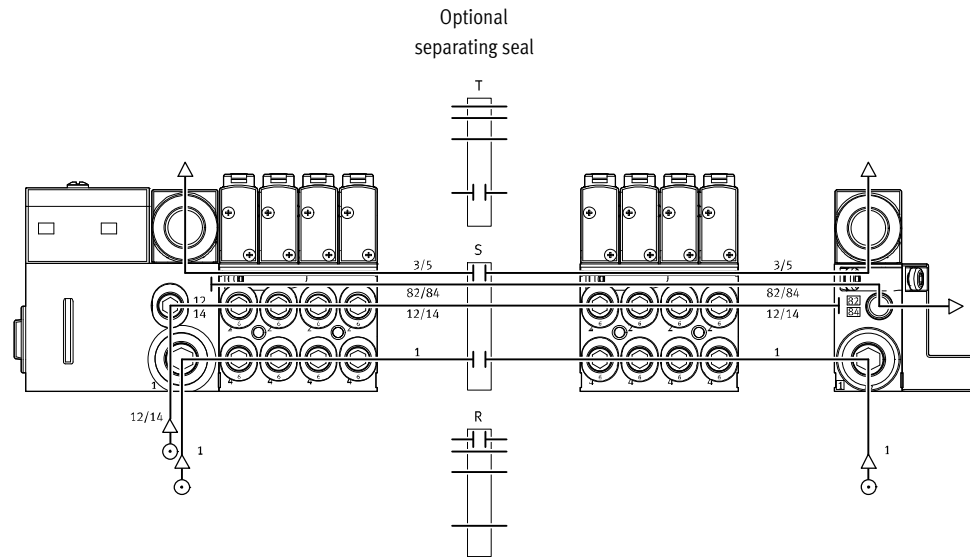



# Valve terminals MPA-S

Key features – Pneumatic components

## Examples: Creating pressure zones

### MPA with CPX terminal connection

The diagram shows an example of the configuration and connection of three pressure zones using separating seals – with external pilot air supply.

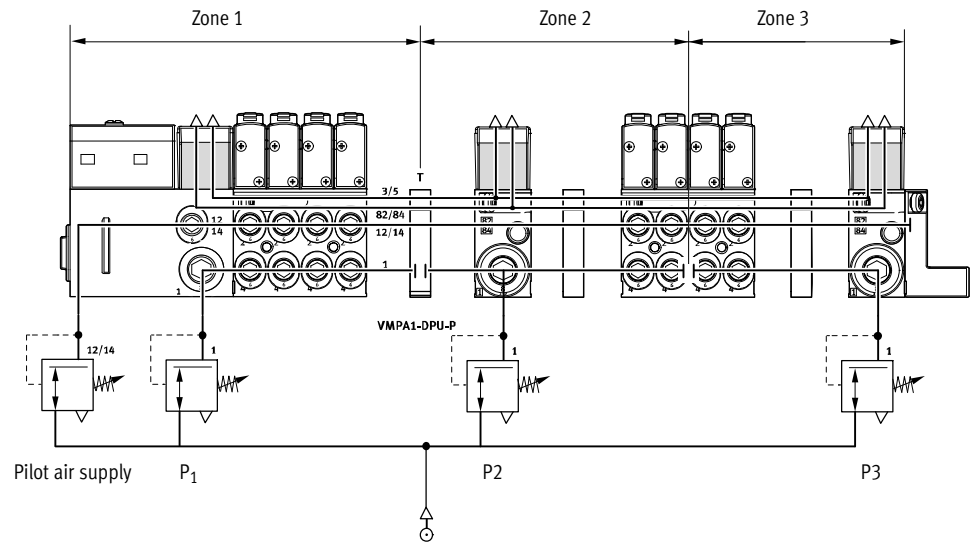

### MPA with multi-pin plug connection

The diagram shows an example of the configuration and connection of the pressure zones – with external pilot air supply.

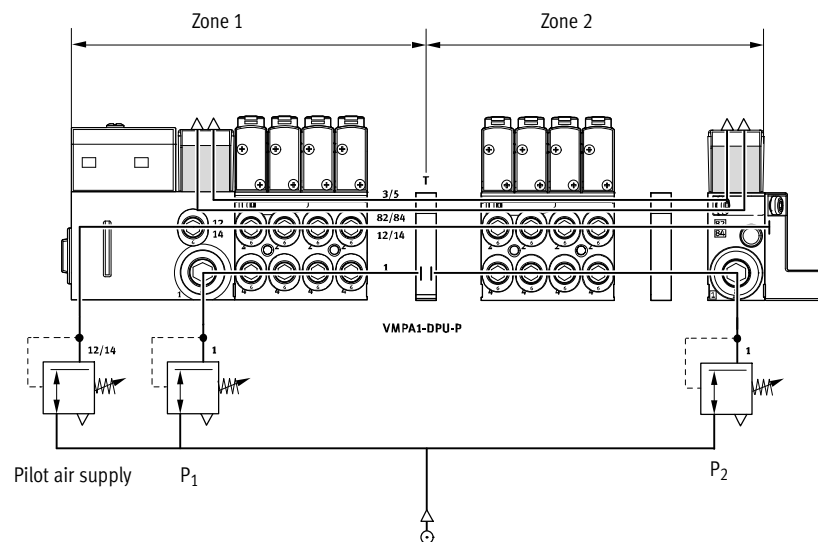

# Valve terminals MPA-S

Key features – Pneumatic components

## Examples: Creating pressure zones

### Manifold block with pressure zone separation in duct 1

Another way of creating pressure zones is to use manifold blocks with pressure zone separation. The diagram opposite shows the version with pressure zone separation in duct 1.

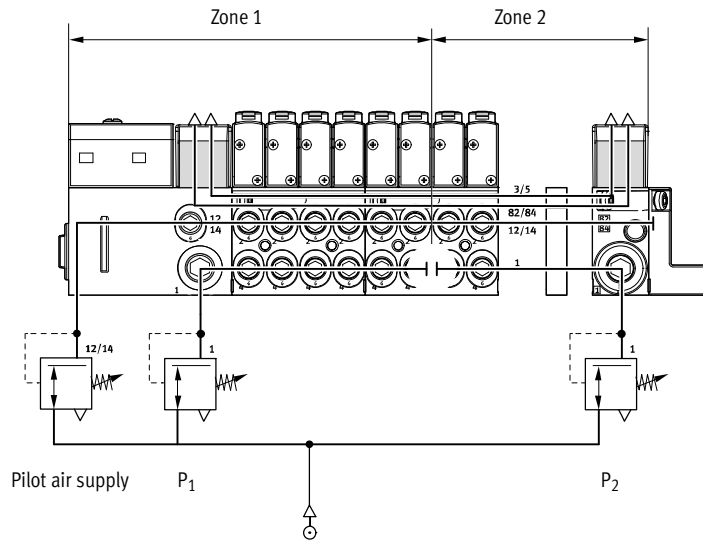

### Manifold block with pressure zone separation in duct 1 and duct 3/5

The diagram opposite shows the version with pressure zone separation in duct 1 and duct 3/5.

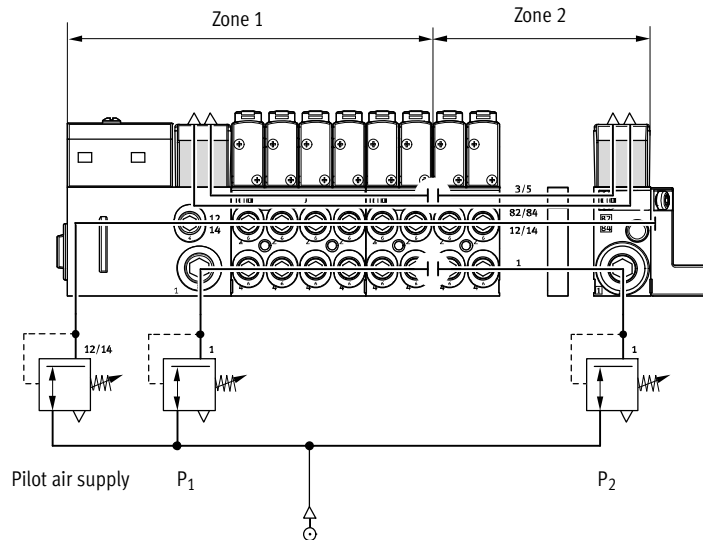

# Valve terminals MPA-S

Key features – Pneumatic components

## Manifold block

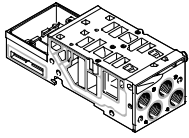

MPA is based on a modular system consisting of manifold blocks and valves. The manifold blocks are screwed together and thus form the support system for the valves. They contain the connection ducts for

supplying compressed air to and venting from the valve terminal as well as the working lines for the pneumatic drives for each valve. Each manifold block is connected to the next using three screws.

Individual terminal sections can be isolated and further manifold blocks inserted by loosening these screws. This ensures that the valve terminal can be rapidly and reliably extended.

Manifold block versions					
Code	Graphical symbol	Type	Width	Number of valve positions (solenoid coils)	Notes
			[mm]		
Manifold block for multi-pin plug/fieldbus connection					
A, C <sup>1)</sup>		VMPA1-FB-AP-4-1	10	4 (8/4 <sup>1)</sup> )	Working lines (2, 4) on the manifold block <ul style="list-style-type: none"> <li>• Connection sizes MPA1: M7, QS4, QS6</li> <li>• Code I: Separation in duct 1 in the manifold block</li> <li>• Code III: Separation in duct 1 and duct 3/5 in the manifold block</li> </ul>
AI, C <sup>1)</sup>		VMPA1-FB-AP-4-1-T1			
AIII, CIII <sup>1)</sup>		VMPA1-FB-AP-4-1-S1			
B, D <sup>1)</sup>		VMPA2-FB-AP-2-1	20	2 (4/2 <sup>1)</sup> )	Working lines (2, 4) on the manifold block <ul style="list-style-type: none"> <li>• Connection sizes MPA2: G1/8, QS6, QS8</li> <li>• Code I: Separation in duct 1 in the manifold block</li> <li>• Code III: Separation in duct 1 and duct 3/5 in the manifold block</li> </ul>
BI, D <sup>1)</sup>		VMPA2-FB-AP-2-1-TO			
BIII, DIII <sup>1)</sup>		VMPA2-FB-AP-2-1-SO			

1) Only possible with multi-pin plug connection

Note  
 More information about individual sub-bases can be found at:  
 → VMPA1

# Valve terminals MPA-S

Key features – Pneumatic components

## Pressure sensor

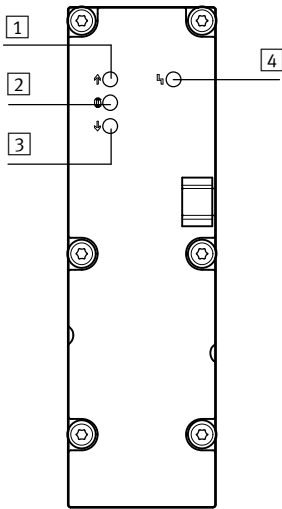

- 1 Red LED: Pressure exceeded
- 2 Green LED: Pressure adhered to
- 3 Red LED: Pressure fallen below
- 4 Red LED: Common error display

The pressure sensor indicates whether the applied pressure exceeds, adheres to or falls below the setpoint value using three LEDs. An additional LED indicates common errors (limit exceeded or fallen below).

The limits for pressure monitoring are set by means of parameter settings. You can parameterise the pressure sensor plate via the PLC or the handheld device (CPXMMI) from Festo.

Alternatively the pressure in the exhaust duct (3/5) and the process pressure (external) can be measured. Pressure measurement in the exhaust duct is used for monitoring the operating pressure during reversible operation (supply to (3/5)).

## Pressure sensor versions

Code	Graphical symbol	Type	Application
PE		VMPA-FB-PS-1	Monitoring the operating pressure in duct 1
PF		VMPA-FB-PS-3/5	Monitoring the pressure in exhaust ducts 3 and 5 (monitoring the venting performance or monitoring pressure in the case of reversible valve terminals)
PG		VMPA-FB-PS-P1	Monitoring an external process pressure

# Valve terminals MPA-S

Key features – Pneumatic components

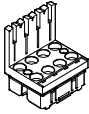
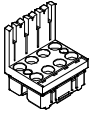
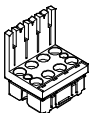
Electrical interface versions					
Code	Graphical symbol	Type	Width	Number of valve positions (solenoid coils)	Notes
			[mm]		
Electronics module for multi-pin plug (MPM)					
A, B, C, D		VMPA1-MPM-EMM-8 VMPA1-MPM-EMM-4	10	4 (8) 4 (4)	Each solenoid coil must be assigned to a specific pin of the multi-pin plug in order for the valve to be actuated. Regardless of the blanking plates or valves used, valve positions occupy <ul style="list-style-type: none"> <li>• 1 address for actuation of 1 coil</li> <li>• 2 addresses for actuation of 2 coils</li> </ul>
		VMPA2-MPM-EMM-4 VMPA2-MPM-EMM-2	20	2 (4) 2 (2)	
Electronics module for fieldbus with standard diagnostics					
A, B, H		VMPA...-FB-EMS-... VMPA...-FB-EMG-...	10	4 (8)	The electronics module contains the serial communication system and facilitates: <ul style="list-style-type: none"> <li>• Transmission of switching information</li> <li>• Actuation of up to 8 solenoid coils</li> <li>• Position-based diagnostics</li> <li>• Separate voltage supply for valves</li> </ul> There are different versions: <ul style="list-style-type: none"> <li>• Without isolated electrical circuit (VMPA...-FB-EMS-...)</li> <li>• With isolated electrical circuit (VMPA...-FB-EMG-...)</li> </ul> Diagnostic function: <ul style="list-style-type: none"> <li>• Error: Load voltage of the valves</li> </ul>
		VMPA...-FB-EMS-... VMPA...-FB-EMG-...	20	2 (4)	
Electronics module for fieldbus with extended diagnostic function					
A, B, H		VMPA...-FB-EMS-...-D2 VMPA...-FB-EMG-...-D2	10	4 (8)	The electronics module with extended diagnostic function contains the same functions as the electronics module with standard diagnostics. The diagnostic function, however, has been extended: <ul style="list-style-type: none"> <li>• Error: Load voltage of the valves</li> <li>• Error: Wire break (open load)</li> <li>• Error: Short circuit in load voltage of valves</li> <li>• Message: Condition monitoring</li> </ul>
		VMPA...-FB-EMS-...-D2 VMPA...-FB-EMG-...-D2	20	2 (4)	

 Note

- Multi-pin plug with modular linking
- Manifold blocks MPA1 and MPA2 can be combined as required
- Positive or negative switching actuation is possible (mixed operation is not permitted)
- Double solenoid valves cannot be mounted on single solenoid electronics modules
- Single solenoid valves can be mounted on double solenoid electronics modules

## Valve terminals MPA-S

Key features – Pneumatic components

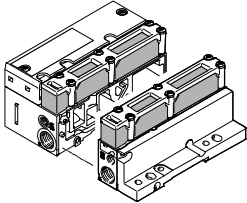
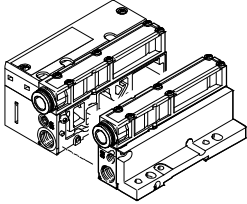
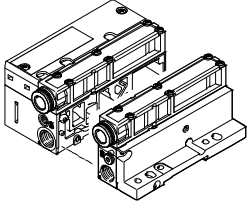
Ports for supply and exhaust							
Code		Port	Designation	Code L Large plug connector	Code K Small plug connector	Code D Thread for supply	
S		Internal pilot air supply, silencer					
		1	Supply air/ vacuum supply	Push-in fitting	QS-G $\frac{1}{4}$ -10-I	QS-G $\frac{1}{4}$ -8-I	G $\frac{1}{4}$
		3/5	Exhaust air	Flat plate silencer	–	–	–
		12/14	Pilot air supply	–	–	–	–
		82/84	Pilot exhaust air	Flat plate silencer	–	–	–
			Pressure compensation	Vents into the atmosphere via silencer			
T		External pilot air supply, silencer					
		1	Supply air/ vacuum supply	Push-in fitting	QS-G $\frac{1}{4}$ -10-I	QS-G $\frac{1}{4}$ -8-I	G $\frac{1}{4}$
		3/5	Exhaust air	Flat plate silencer	–	–	–
		12/14	Pilot air supply	Push-in fitting	QSM-M7-6-I	QSM-M7-6-I	M7
		82/84	Pilot exhaust air	Flat plate silencer	–	–	–
			Pressure compensation	Vents into the atmosphere via silencer			
V		Internal pilot air supply, ducted exhaust air					
		1	Supply air/ vacuum supply	Push-in fitting	QS-G $\frac{1}{4}$ -10-I	QS-G $\frac{1}{4}$ -8-I	G $\frac{1}{4}$
		3/5	Exhaust air	Push-in fitting	QS-10	QS-10	QS-10
		12/14	Pilot air supply	–	–	–	–
		82/84	Pilot exhaust air	Push-in fitting	QSM-M7-6-I	QSM-M7-6-I	M7
			Pressure compensation	Vents into duct 82/84			
X		External pilot air supply, ducted exhaust air					
		1	Supply air/ vacuum supply	Push-in fitting	QS-G $\frac{1}{4}$ -10-I	QS-G $\frac{1}{4}$ -8-I	G $\frac{1}{4}$
		3/5	Exhaust air	Push-in fitting	QS-10	QS-10	QS-10
		12/14	Pilot air supply	Push-in fitting	QSM-M7-6-I	QSM-M7-6-I	M7
		82/84	Pilot exhaust air	Push-in fitting	QSM-M7-6-I	QSM-M7-6-I	M7
			Pressure compensation	Vents into duct 82/84			
Y		Internal pilot air supply, ducted exhaust air via right-hand end plate (VMPA-EPR-G)					
		1	Air/vacuum supply	Push-in fitting	QS-G $\frac{1}{4}$ -10-I	QS-G $\frac{1}{4}$ -8-I	G $\frac{1}{4}$
		3/5	Exhaust air	Push-in fitting	QS-10	QS-10	QS-10
		12/14	Pilot air supply	–	–	–	–
		82/84	Pilot exhaust air	Push-in fitting	QSM-M5-3-I	QSM-M5-3-I	M5
			Pressure compensation	Exhausts into duct 82/84			
Z		External pilot air supply, ducted exhaust air via right-hand end plate (VMPA-EPR-G)					
		1	Air/vacuum supply	Push-in fitting	QS-G $\frac{1}{4}$ -10-I	QS-G $\frac{1}{4}$ -8-I	G $\frac{1}{4}$
		3/5	Exhaust air	Push-in fitting	QS-10	QS-10	QS-10
		12/14	Pilot air supply	Push-in fitting	QSM-M7-6-I	QSM-M7-6-I	M7
		82/84	Pilot exhaust air	Push-in fitting	QSM-M5-3-I	QSM-M5-3-I	M5
			Pressure compensation	Exhausts into duct 82/84			

# Valve terminals MPA-S

Key features – Assembly

## Valve terminal assembly

Sturdy terminal assembly thanks to:

- Four through-holes for wall mounting
- Additional mounting brackets
- H-rail mounting

 Note

When wall-mounting MPA valve terminals with more than 4 manifold blocks, use additional mounting brackets of the type VMPA-BG-RW to

prevent damage to the valve terminal. The mounting brackets can be mounted on the pneumatic supply plates.

## Wall mounting – Multi-pin plug connection, AS-interface and CPI connection

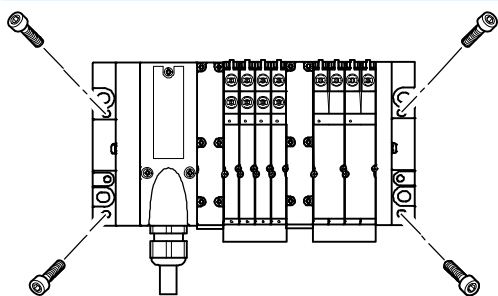

The MPA valve terminal is screwed onto the mounting surface using four M4 or M6 screws. The mounting holes are on the pneumatic interface

and on the right-hand end plate. There are also optional mounting brackets available.

## Wall mounting – Fieldbus connection

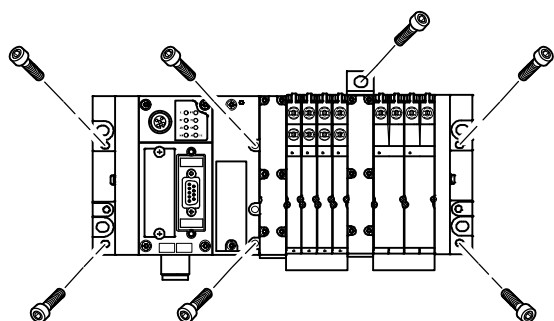

The MPA valve terminal is screwed onto the mounting surface using six M4 or M6 screws. The mounting holes are on the left-hand end plate (CPX) and on the right-hand end plate (MPA).

The pneumatic interface also provides further mounting holes as well as optional mounting brackets.

## H-rail mounting

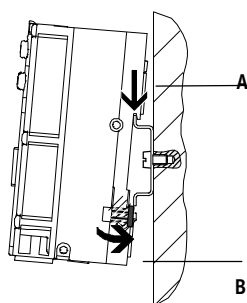

The MPA valve terminal is attached to the H-rail (see arrow A). The terminal is then swivelled around the H-rail and secured in place with the clamping component (see arrow B).

For H-rail mounting of the valve terminal you will need the following MPA mounting kit:

- With multi-pin plug: CPA-BG-NRH
- With fieldbus: CPX-CPA-BG-NRH

This enables mounting of the valve terminal on a H-rail to EN 60715.

 Note

More information about assembly of solenoid valves on individual sub-bases can be found at:

→ VMPA1

# Valve terminals MPA-S

Key features – Display and operation

## Display and operation

Each solenoid coil is allocated an LED that indicates its signal status.

- Indicator 12 shows the signal status of the coil for output 2
- Indicator 14 shows the signal status of the coil for output 4

### Manual override

The manual override (MO) enables the valve to be actuated when not electrically activated or energised. The valve is switched by pushing the manual override. The set switching status can also be locked by turning the manual override (code R).

Alternatives:

- The cover cap (code N or as an accessory) prevents the manual override from being locked. The manual override can then only be activated by pushing it.
- The cover cap (code V or as an accessory) can prevent the manual override from being accidentally activated.
- The cover cap (code Y or as an accessory) can be used to operate the manual override in detenting mode without additional tools.

## Pneumatic connection and control elements

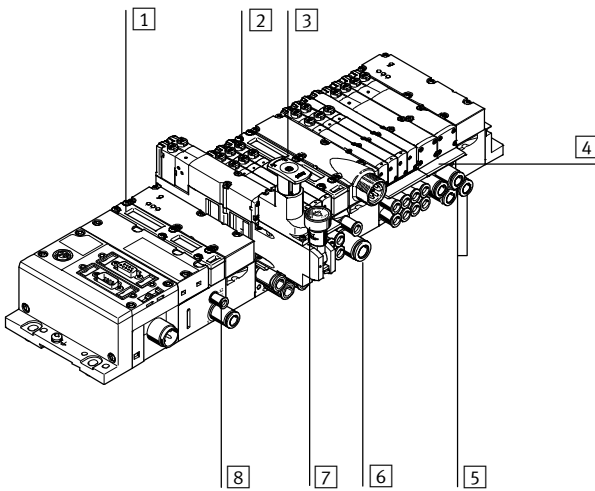

- 1 Flat plate silencer for exhaust port 3/5
- 2 Manual override (for each pilot solenoid coil, non-detenting or non-detenting/detenting)
- 3 Adjusting knob of optional pressure regulator plate
- 4 Inscription label holder for manifold block
- 5 Working lines 2 and 4, for each valve position
- 6 Supply port 1
- 7 Pressure gauge (optional)
- 8 Ports 12 and 14 for supplying the external pilot air

### Note

A manually actuated valve (manual override) cannot be reset electrically. Conversely, an electrically actuated valve cannot be reset using the mechanical manual override.

## Electrical connection and display components on the AS-interface

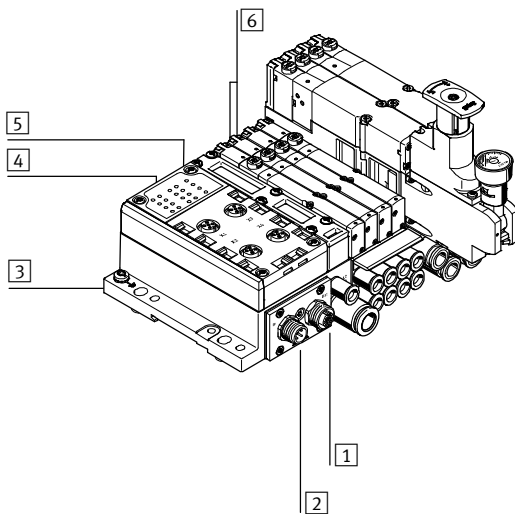

- 1 M12 socket for AS-interface bus and additional supply (AS-i Out)
- 2 M12 plug for AS-interface bus and additional supply (AS-i In)
- 3 Earth terminal
- 4 Status LEDs for inputs
- 5 Status LEDs for AS-interface
- 6 Diagnostic LEDs for valves



# Valve terminals MPA-S

Key features – Display and operation

## Manual override (MO)

### MO with automatic return (non-detenting)

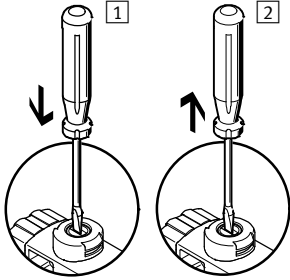

- 1 Press in the stem of the MO with a pointed object or screwdriver. Pilot valve switches and actuates the main valve.
- 2 Remove the pointed object or screwdriver. Spring force pushes the stem of the MO back. Pilot valve returns to its normal position as does the single solenoid main valve (not the case with double solenoid valve code J).

### MO with lock (detenting)

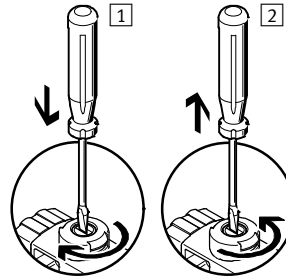

- 1 Press in the stem of the MO with a pointed object or screwdriver until the valve switches and then turn the stem clockwise by 90° until the stop is reached. Valve remains switched.
- 2 Turn the stem anti-clockwise by 90° until the stop is reached and then remove the pointed object or screwdriver. Spring force pushes the stem of the MO back. The valve returns to its normal position (not the case with double solenoid valve code J).

### MO with automatic return (non-detenting)

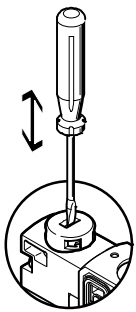

Manual override is actuated by pushing with a pointed object or screwdriver and reset by spring force (detenting position prevented by coded cover cap). Valves can be ordered with a fitted cover cap in the valve terminal configurator using the selection menu “Manual override” (code N).

### MO with lock – Assembly



Clip MO with lock onto the pilot valve. The MO cap can then be operated (detenting) without tools. Valves can be ordered with a fitted cover cap in the valve terminal configurator using the selection menu “Manual override” (code Y).

### MO with lock – Actuation

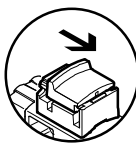

Sliding the cap for the MO with lock in the direction of the arrow causes the following to happen:

- Cap locks into the end position.
- Pilot valve switches and actuates the main valve.

### MO with lock – Actuation

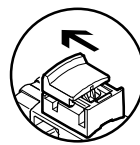

Sliding the cap for the MO with lock in the direction of the arrow causes the following to happen:

- Cap locks into the end position.
- Spring force pushes the stem of the MO back.
- Pilot valve returns to its normal position as does the single solenoid main valve (not the case with double solenoid valve code J).

## Inscription system

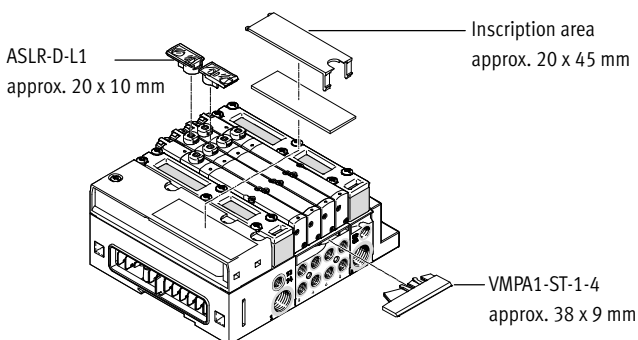

To label the valves, an inscription label holder VMPA1-ST-1-4 or VMPA1-ST-2-4 (for holding inscription labels IBS-6x10) can be fitted to each manifold block with a width of 42 mm. The inscription label holder ASLR-D-L1 can be pushed onto the manual

override. As an alternative or in addition, large inscription labels can be applied to the pneumatic interface: Inscription labels 20 x 45 mm are suitable for this purpose, see → page 83

# Valve terminals MPA-S

Key features – Electrical components

## Electrical power as a result of current reduction

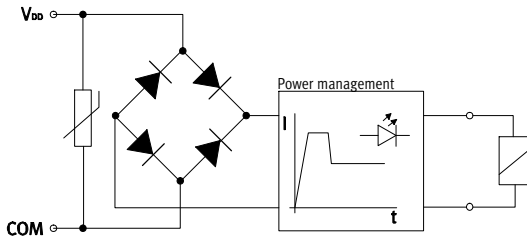

Each MPA solenoid coil is protected with a spark arresting protective circuit as well as against polarity reversal. All valve types are additionally equipped with integrated current reduction.

MPA valves are supplied with operating voltage in the range 18 ... 30 V (24 V +/-25%). This high tolerance is made possible through integrated control electronics and offers additional security, e.g. if the operating voltage drops.

## Individual valve

Valves can also be used on individual sub-bases for actuators further away from the valve terminal.

- Detachable electronics module with integrated holding current reduction
- Electrical M8 connection, 4-pin with screw connection

**Note**  
More information about individual sub-bases can be found at:

## Electrical multi-pin plug connection

The following multi-pin plug connection is offered for the valve terminal MPA:

- Sub-D multi-pin plug connection (25-pin)

Pins 1 ... 24 are used for addresses 1 ... 24 in order.

If fewer than 24 addresses are used for the valve terminal, the remaining

pins up to 24 are left free. Pin 25 is reserved for the neutral conductor. The valves are switched by means of positive or negative logic (PNP or NPN). Mixed operation is not permitted.

Each pin on the multi-pin plug can actuate exactly one solenoid coil. If the maximum configurable number

of valve positions is 24, this means that 24 valves can be addressed with one solenoid coil. With 12 or less valve positions, 2 solenoid coils per valve can be addressed. With 12 or more valve positions, the number of available valve positions for valves with two solenoid coils decreases.

**Note**  
If a single solenoid valve is assembled on a double solenoid valve position, the second address is also occupied and cannot be used.

## Guidelines on addressing for valves/solenoid coils

- The maximum possible number of addresses with a multi-pin plug connection is 24.
- Each manifold block/electronics module occupies a defined number of addresses/pins:
  - Manifold block MPA1 for 4 double solenoid valves: 8
  - Manifold block MPA2 for 2 single solenoid valves: 2
  - Manifold block MPA2 for 2 double solenoid valves: 4
- The numbering of the addresses goes from left to right in ascending consecutive order. The following applies to the individual valve positions: address x for coil 14 and address x+1 for coil 12.
- If single solenoid valves are mounted on manifold blocks for double solenoid valves, the address of coil 12 and the assigned pin will remain unused.

## Valve terminals MPA-S

Key features – Electrical components

### AS-interface® fieldbus connection

The AS-interface facilitates the spatial distribution of individual components or small component groups. The AS-interface connection of valve

terminal MPA can be used to control up to 8 solenoid coils. The electrical connection of the valve

terminal contains the LEDs that indicate the operating status and the protective circuit for the valves.

 Note  
For further information see  
➔ Internet: [as-interface](#)

### CPI fieldbus connection

All CP valve terminals and CP modules are connected using a ready-to-install CP cable, and are attached to the CP interface. Four modules, for example

one CPV valve terminal and one to three CP input modules, make up an installation string that ends at the CP interface. The installation system

supports a maximum of 4 installation strings that can be connected to a CP fieldbus node.

 Note  
For further information see  
➔ Internet: [ctec](#)

### CPX fieldbus connection

All functions and features of the electrical peripherals CPX are supported in connection with the CPX interface. This means:

- The valves and electrical outputs are supplied via the operating voltage connection CPX
- The valves are supplied and disconnected separately via a separate valve connection on the CPX (code V)

 Note  
For further information see  
➔ Internet: [cpx](#)

# Valve terminals MPA-S

Key features – Electrical components



## Pin allocation – Sub-D socket, cable

	Pin	Address/coil	Wire colour <sup>2)</sup>		Pin	Address/coil	Wire colour <sup>2)</sup>
	1	0	WH		17	16	WH PK
	2	1	GN		18	17	PK BN
	3	2	YE		19	18	WH BU
	4	3	GY		20	19	BN BU
	5	4	PK		21	20	WH RD
	6	5	BU		22	21	BN RD
	7	6	RD		23	22	WH BK
	8	7	VT		24	23	BN
	9	8	GY PK		25	0 V <sup>1)</sup>	BK
	10	9	RD BU				
	11	10	WH GN				
	12	11	BN GN				
	13	12	WH YE				
	14	13	YE BN				
	15	14	WH GY				
	16	15	GY BN				

Note  
The drawing shows a view on the Sub-D socket on the multi-pin cable VMPA-KMS1-....

1) 0 V for positive switching control signals; connect 24 V for negative switching control signals; mixed operation is not permitted.  
2) To IEC 757.

## Dimensions

Download CAD data → [www.festo.com](http://www.festo.com)

Connecting cable

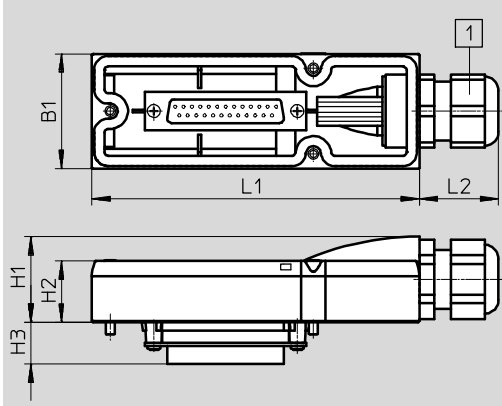

1 Cable conduit fitting with clamping range 6 ... 12 mm

The wire colours refer to the following pre-assembled multi-pin cables from Festo:

- VMPA-KMS1-8-... Valve terminal for up to 4 valve positions (8 coils)
- VMPA-KMS1-24-... Valve terminal with 8 ... 24 valve positions

Type	L1	L2	B1	H1	H2	H3
VMPA-KMS-H	107.3	26	37.6	28	20	13.8

Type	Sheath	Length [m]	Core x mm <sup>2</sup>	D [mm]	Part No.
VMPA-KMS1-8-2.5	PVC	2.5	10 x 0.34	6.9	533195
VMPA-KMS2-8-2.5-PUR	PUR	2.5	10 x 0.25	8.3	533504
VMPA-KMS1-8-5	PVC	5	10 x 0.34	6.9	533196
VMPA-KMS2-8-5-PUR	PUR	5	10 x 0.25	8.3	533505
VMPA-KMS1-8-10	PVC	10	10 x 0.34	6.9	533197
VMPA-KMS2-8-10-PUR	PUR	10	10 x 0.25	8.3	533506
VMPA-KMS1-24-2.5	PVC	2.5	25 x 0.34	11.4	533192
VMPA-KMS2-24-2.5-PUR	PUR	2.5	25 x 0.25	11.2	533501
VMPA-KMS1-24-5	PVC	5	25 x 0.34	11.4	533193
VMPA-KMS2-24-5-PUR	PUR	5	25 x 0.25	11.2	533502
VMPA-KMS1-24-10	PVC	10	25 x 0.34	11.4	533194
VMPA-KMS2-24-10-PUR	PUR	10	25 x 0.25	11.2	533503
VMPA-KMS-H	Cover for self-assembly				533198

# Valve terminals MPA-S



Key features – Electrical components

FESTO

Instructions for use			
Equipment		Bio-oils	Mineral oils
<p>Operate your equipment with unlubricated compressed air if possible. Festo valves and cylinders are designed so that, if used as designated, they will not require additional lubrication and will still achieve a long service life. The quality of compressed air downstream from the compressor must correspond to that of unlubricated compressed air. If possible, do not operate all of your equipment with lubricated compressed air. The lubricators should, where possible, always be installed directly upstream of the actuator used.</p>	<p>Unsuitable additional oil and an excessive oil content in the compressed air reduce the service life of the valve terminal. Use Festo special oil OFSW-32 or the alternatives listed in the Festo catalogue (as specified in DIN 51524 HLP32; basic oil viscosity 32 CST at 40 °C).</p>	<p>When using bio-oils (oils that are based upon synthetic or native ester, e.g. rapeseed oil methyl ester), the maximum residual oil content of 0.1 mg/m<sup>3</sup> must not be exceeded (see ISO 8573-1 Class 2).</p>	<p>When using mineral oils (e.g. HLP oils to DIN 51524, parts 1 to 3) or similar oils based on poly-alpha-olefins (PAO), the maximum residual oil content of 5 mg/m<sup>3</sup> must not be exceeded (see ISO 8573-1 Class 4). A higher residual oil content irrespective of the compressor oil cannot be permitted, as the basic lubricant would be flushed out over time.</p>

## Valve terminals MPA-S

Technical data

-  Flow rate  
MPA1: Up to 360 l/min  
MPA2: Up to 700 l/min
  
-  Valve width  
MPA1: 10 mm  
MPA2: 20 mm
  
-  Voltage  
24 V DC



General technical data	
Valve terminal design	Modular, valve sizes can be mixed
Electrical actuation	Fieldbus      Multi-pin plug      AS-i interface      CPI interface
Actuation type	Electric
Nominal voltage [V DC]	24
Operating voltage range [V DC]	18 ... 30
Residual ripple [Vss]	4
Max. no of valve positions	64 (FB), 24 (MP)
Valve size [mm]	10, 20
Pilot air supply	Internal or external
Lubrication	Life-time lubrication, PWIS-free (free of paint-wetting impairment substances)
Type of mounting	Wall mounting On H-rail to EN 60715
Mounting position	Any (wall mounting) Horizontal only (H-rail)
Manual override	Non-detenting, detenting
Protection class to EN 60529	IP65 (for all types of signal transmission in assembled state)
Pneumatic connections	
Pneumatic connection	Via manifold block or individual connection
Supply port 1	G $\frac{1}{4}$ (M7 with individual sub-base)
Exhaust port 3/5	QS-10, QS-3/8" (M7 with individual sub-base)
Working ports 2/4	Dependent on the connection type selected MPA1: M7, QS4, QS6, 3/16", 1/4" MPA2: G $\frac{1}{8}$ , QS6, QS8, 1/4", 5/16"
Pilot air port 12/14	M7 (M5 with individual sub-base)
Pilot exhaust air port 82/84	M7 (M5 with individual sub-base)
Pressure compensation port	With ducted exhaust air: via port 82/84 (M5 for individual sub-base and for end plate VMPA-EPR-G) With flat plate silencer: exhaust to atmosphere

-  - Note

Note possible restrictions for the IP protection class

➔ ATEX conformity declaration

# Valve terminals MPA-S

Technical data

FESTO

Operating and environmental conditions	
Operating medium	Compressed air according to ISO 8573-1:2010 [7:4:4]
Note on operating/pilot medium	Lubricated operation possible (in which case lubricated operation will always be required)
Operating pressure [bar]	-0.9 ... 10
Pilot pressure [bar]	3 ... 8
Ambient temperature [°C]	-5 ... +50
Temperature of medium [°C]	-5 ... +50
Storage temperature <sup>1)</sup> [°C]	-20 ... +40
Relative air humidity at 40 °C [%]	90

1) Long-term storage

Certifications <sup>1)</sup>				
Type	MPA-MPM-VI (multi-pin plug interface)	MPA-FB-VI (fieldbus interface)	MPA-ASI-VI (AS-i interface)	MPA-CPI-VI (CPI interface)
Part number	539105	530411	546279	546280
ATEX category for gas	II 3 G		II 3 G	
Explosion ignition protection type for gas	Ex nA IIC T4 X Gc		Ex nA IIC T4 X Gc	
ATEX temperature rating [°C]	-5 ≤ Ta ≤ +50		-5 ≤ Ta ≤ +50	
Explosion protection certification outside the EU	-	GOST-R EPL Dc GOST-R EPL Gc	-	-
CE marking (see declaration of conformity)	To EU EMC Directive <sup>2)</sup> To EU Explosion Protection Directive (ATEX)	To EU EMC Directive <sup>2)</sup> To EU Explosion Protection Directive (ATEX)	To EU EMC Directive <sup>2)</sup> To EU Explosion Protection Directive (ATEX)	To EU EMC Directive <sup>2)</sup> To EU Explosion Protection Directive (ATEX)
Certification	cULus recognized (OL)	cULus recognized (OL)	cULus recognized (OL)	cULus recognized (OL)
Corrosion resistance class CRC <sup>3)</sup>	1	1	0	0

1) Interface versions not listed do not have any of the listed certifications

2) For information about the applicability of the component see the manufacturer's EC declaration of conformity at: [www.festo.com/sp](http://www.festo.com/sp) → User documentation.

If the component is subject to restrictions on usage in residential, office or commercial environments or small businesses, further measures to reduce the emitted interference may be necessary.

3) Corrosion resistance class 1 according to Festo standard 940 070

Components subject to low corrosion stress. Transport and storage protection. Parts that do not have primarily decorative surface requirements, e.g. in internal areas that are not visible or behind covers.

# Valve terminals MPA-S

Technical data

FESTO

## Pilot pressure $p_2$ as a function of working pressure $p_1$ with external pilot air supply

For valves with code: M, J, B, G, E, W, X

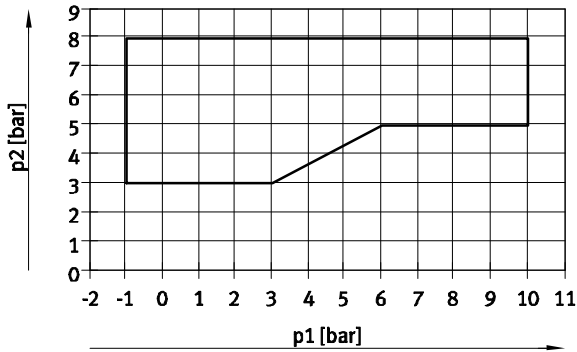

1 Operating range for valves with external pilot air supply

For valves with code: N, K, H, D, I

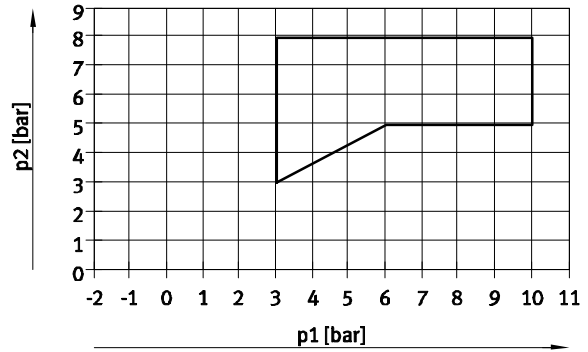

1 Operating range for valves with external pilot air supply

## Pilot pressure $p_2$ as a function of working pressure $p_1$ for valves with mechanical spring return

For valves in width 10 mm with code: MS, NS, KS, HS, DS

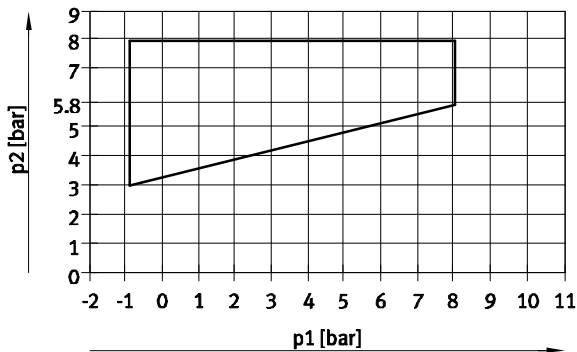

For valves in width 20 mm with code: MS, NS, KS, HS, DS

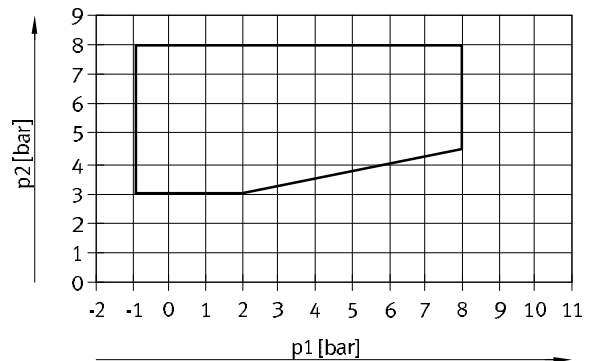

For valves in width 10 mm with code: MU, NU, KU, HU

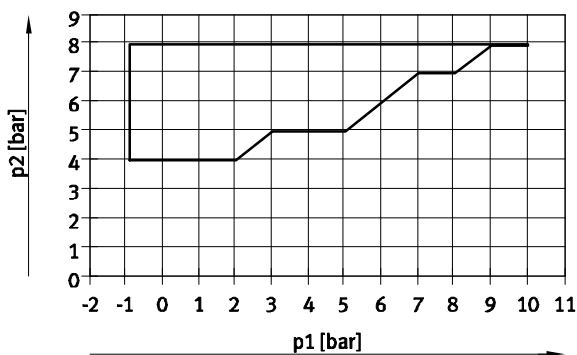



# Valve terminals MPA-S

Technical data

Flow rate  $q_n$  as a function of output pressure  $p_2$  with pressure regulator plates (width 20 mm)

(P regulator plate) for port 1

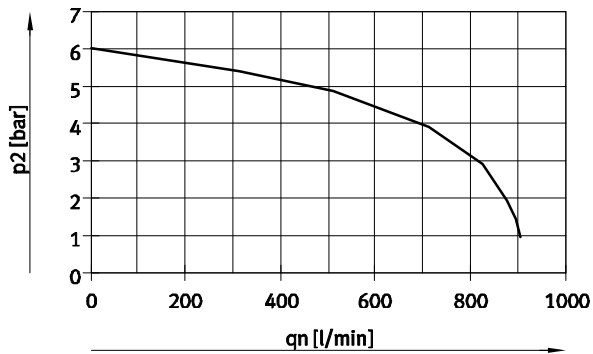

Supply pressure 10 bar,  
set regulated pressure 6 bar

(B regulator plates) for port 2

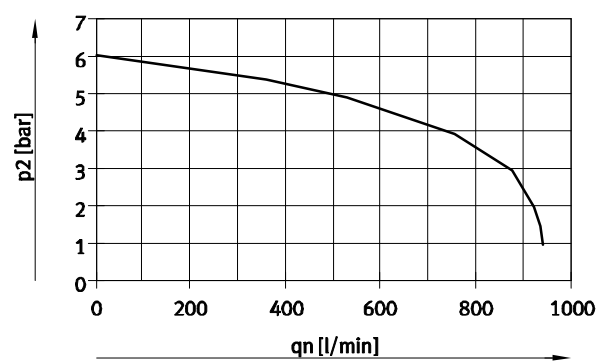

Supply pressure 10 bar,  
set regulated pressure 6 bar

Flow rate  $q_n$  as a function of output pressure  $p_2$  with pressure regulator plates (width 20 mm)

(A regulator plates) for ports 4

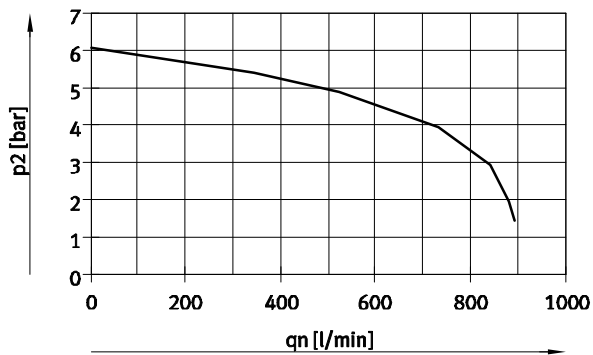

Supply pressure 10 bar,  
set regulated pressure 6 bar

(B regulator plates, rev.) for ports 3, reversible

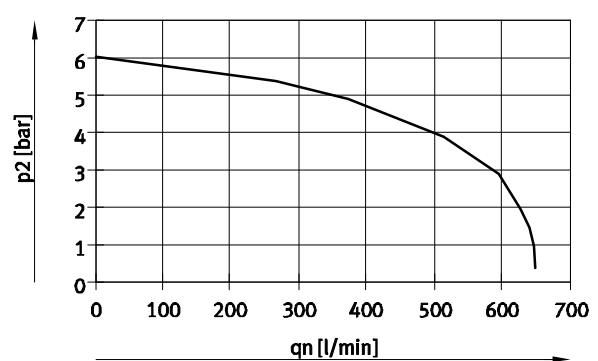

Supply pressure 10 bar,  
set regulated pressure 6 bar

Flow rate  $q_n$  as a function of output pressure  $p_2$  with pressure regulator plates (width 20 mm)

(A regulator plates, rev.) for ports 5, reversible

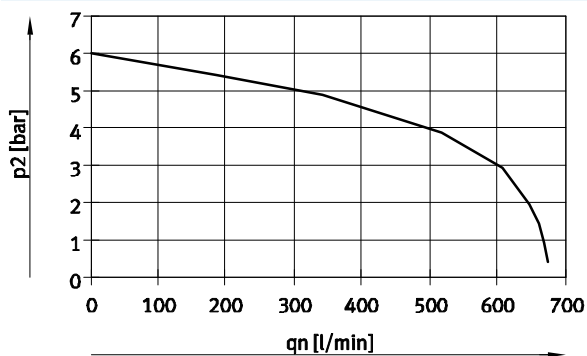

Supply pressure 10 bar,  
set regulated pressure 6 bar

# Valve terminals MPA-S

Technical data

Technical data – Valves in width 10 mm														
Code			M	J	N	K	H	B	G	E	X	W	D	I
Switching times	On	[ms]	10	10	10	10	10	10	10	10	10	10	10	10
	Off	[ms]	20	–	20	20	20	35	35	35	20	20	20	20
	Change-over	[ms]	–	15	–	–	–	15	15	15	–	–	–	–
Operating pressure	[bar]	–0.9 ... +10			3 ... 10			–0.9 ... +10					3 ... 10	
Standard nominal flow rate	[l/min]	360	360	300	230	300	300	320	240	255	255	230	260	
Design		Piston spool valve												
Max. tightening torque of valve mounting	[Nm]	0.25												
Materials		Die-cast aluminium												
Product weight	[g]	49	56	56	56	56	56	56	56	49	49	56	56	

Technical data – Valves in width 10 mm												
Code			MS	NS	KS	HS	DS	MU	NU	KU	HU	
Switching times	On	[ms]	10	14	14	14	14	10	8	8	8	
	Off	[ms]	27	16	16	16	16	12	8	10	10	
	Change-over	[ms]	–	–	–	–	–	–	–	–	–	
Operating pressure	[bar]	–0.9 ... +8						–0.9 ... +10				
Standard nominal flow rate	[l/min]	360	300	230	300	230	190	190	160	190		
Design		Piston spool valve						Poppet valve with spring return				
Max. tightening torque of valve mounting	[Nm]	0.25										
Materials		Die-cast aluminium						Reinforced PPA				
Product weight	[g]	56	56	56	56	56	35	42	42	42		

Technical data – Valves in width 20 mm																			
Code			M	J	N	K	H	B	G	E	X	W	D	I	MS	NS	KS	HS	DS
Switching times	On	[ms]	15	9	8	8	8	11	10	11	13	13	7	7	8	12	12	12	12
	Off	[ms]	28	–	28	28	28	46	40	47	22	22	25	25	36	25	25	25	25
	Change-over	[ms]	–	22	–	–	–	23	21	23	–	–	–	–	–	–	–	–	–
Operating pressure	[bar]	–0.9 ... +10			3 ... 10			–0.9 ... +10					3 ... 10		–0.9 ... +8				
Standard nominal flow rate	[l/min]	700	670	550	500	550	510	610	590	470	470	650	680	670	550	500	550	650	
Design		Piston spool valve																	
Max. tightening torque of valve mounting	[Nm]	0.65																	
Materials		Die-cast aluminium																	
Product weight	[g]	100																	

# Valve terminals MPA-S

Technical data

Electrical data – MPA with electronics module VMPA...-FB... (CPX terminal, CPI interface)			
		MPA1	MPA2
Intrinsic current consumption per electronics module			
At 24 V $U_{EL/SEN}$ <sup>1)</sup> (internal electronics, all outputs 0 signal)	[mA]	Typically 8	
At 24 V $U_{VAL}$ <sup>2)</sup> (internal electronics, without valves)			
VMPA...-EMG..., separate circuits	[mA]	Typically 23 mA	
VMPA...-EMS..., with separate circuits	[mA]	Typically 3 mA	
Maximum current consumption per solenoid coil at nominal voltage			
Nominal pick-up current	[mA]	58	99
Nominal current following current reduction	[mA]	9	18
Time until current reduction	[ms]	24	24
Diagnostic message			
Undervoltage $U_{OFF}$ <sup>3)</sup>	[V]	17.5 ... 16	

Electrical data – MPA with electronics module VMPA...-MPM... (AS-i interface, multi-pin plug)			
		MPA1	MPA2
Current consumption at Sub-D multi-pin plug connection per solenoid coil at nominal voltage			
Nominal pick-up current	[mA]	80	100
Nominal current with current reduction	[mA]	25	20
Time until current reduction	[ms]	25	50

Calculation example for current consumption (CPX terminal, CPI interface)			
Current consumption with two solenoid coils MPA2 switched in parallel and one electronics module VMPA...-EMS... without separate circuits	[mA]	$I_{EL/SEN} = 8$	
Nominal pick-up current (duration 24 ms)	[mA]	$I_{VAL} = 3$ (intrinsic current consumption of electronics module) + 2 x 99 (MPA2) = 202	
Nominal current with current reduction (after 24 ms)	[mA]	$I_{VAL} = 3$ (intrinsic current consumption of electronics module) + 2 x 18 (MPA2) = 39	

- 1) Power supply for electronics and sensors
- 2) Load voltage supply for valves
- 3) Load voltage outside of function range

# Valve terminals MPA-S

Technical data

Data on vibration and shock <sup>1) 2) 4)</sup> to DIN/IEC68	
Vibration	Tested according to DIN/IEC68 / EN60068 parts 2 ... 6 With horizontal H-rail mounting: severity level 1 With wall mounting: <sup>2) 3)</sup>
Shock	Tested according to DIN/IEC68 / EN60068 parts 2 ... 27 With horizontal H-rail mounting: severity level 1 With wall mounting: severity level 1 ... <sup>2)</sup>
Continuous shock	Tested according to DIN/IEC68 / EN 60068 parts 2 ... 29 With wall and H-rail mounting: severity level 1

1) See the CPX System manual for information on vibration and shock for the CPX terminal.

2) Valve terminal MPA-S with CPX terminal:

up to a length of 280 mm between the pneumatic interface and right-hand end plate, without additional fastening: severity level 2

above a length of 280 mm between the pneumatic interface and right-hand end plate, with additional fastening at the pneumatic supply plates: severity level 2

3) Valve terminal MPA-S with CPI, with AS-i or with multi-pin plug connection:

up to a valve terminal length of 280 mm, without additional fastening: severity level 2

above a valve terminal length of 280 mm, with at least one additional fastening in the centre of the valve terminal at the pneumatic supply plate: severity level 2

4) See table below for explanations of the severity levels.

Test conditions			
Severity level	Vibration	Shock	Continuous shock
1	0.15 mm travel at 10 ... 58 Hz, 2 g acceleration at 58 ... 150 Hz	±15 g at 11 ms duration, 5 shocks per direction	±15 g at 6 ms duration, 1,000 shocks per direction
2	0.35 mm travel at 10 ... 60 Hz, 5 g acceleration at 60 ... 150 Hz	±30 g at 11 ms duration, 5 shocks per direction	-
Continuous shock resistance	To DIN/IEC 68/EN 60068, parts 2-29: +/-15 g at 6 ms, 1,000 cycles		

# Valve terminals MPA-S

Technical data

Materials	
Manifold block	Die-cast aluminium
Seals	Nitrile rubber, elastomer
Supply plate	Die-cast aluminium
Right-hand end plate	Die-cast aluminium
Left-hand pneumatic interface	Die-cast aluminium, polyamide
Exhaust plate	Polyamide
Flat plate silencer	Polyethylene
Electrical supply plate	Housing: Die-cast aluminium End cap: Reinforced polyamide
Electronics module	Polycarbonate
Electrical interlinking module	Bronze/polybutylene terephthalate
Regulator plate	Control section, housing: Polyamide; Seals: Nitrile rubber
Note on materials	RoHS-compliant

Product weight		
Approx. weight [g]	MPA1	MPA2
Manifold block basic weight <sup>1)</sup>	400 (4 valve positions)	400 (2 valve positions)
Sub-base <sup>1)</sup>	185	
Individual sub-base	45	
Per vacant position L	24	44
Right-hand end plate	55	
Left-hand pneumatic interface <sup>1)</sup>		
• With flat plate silencer	315	
• With ducted exhaust air	324	
Supply plate <sup>1)</sup>		
• With flat plate silencer	111	
• With ducted exhaust air	120	
Electrical supply plate	200	
Regulator plate (MPA1)	73.8	
Regulator plate (MPA2)	180	
QSM-M5-3-I	3	
QSM-M5-5/32-I-U-M	3	
QSM-M5-4-I	4	
QSM-M5-3/16-I-U-M	4	
QSM-M5-6-I	5	
QSM-M5-1/4-I-U-M	5	
QSM-M7-4-I	4	
QSM-M7-3/16-I-U-M	4	
QSM-M7-6-I	5	
QSM-M7-1/4-I-U-M	5	
QS-G $\frac{1}{8}$ -6-I	11	
QS-1/8-1/4-I-U-M	11	
QS-G $\frac{1}{8}$ -8-I	13	
QS-1/8-5/16-I-U-M	13	
QS-G $\frac{1}{4}$ -8-I	22	
QS-1/4-5/16-I-U-M	22	
QS-G $\frac{1}{4}$ -10-I	22	
QS-1/4-3/8-I-U-M	22	

1) With sheet metal seal, inscription label holder, screws

# Valve terminals MPA-S

Technical data

## Dimensions

Download CAD data → [www.festo.com](http://www.festo.com)

Valve terminal with multi-pin plug connection

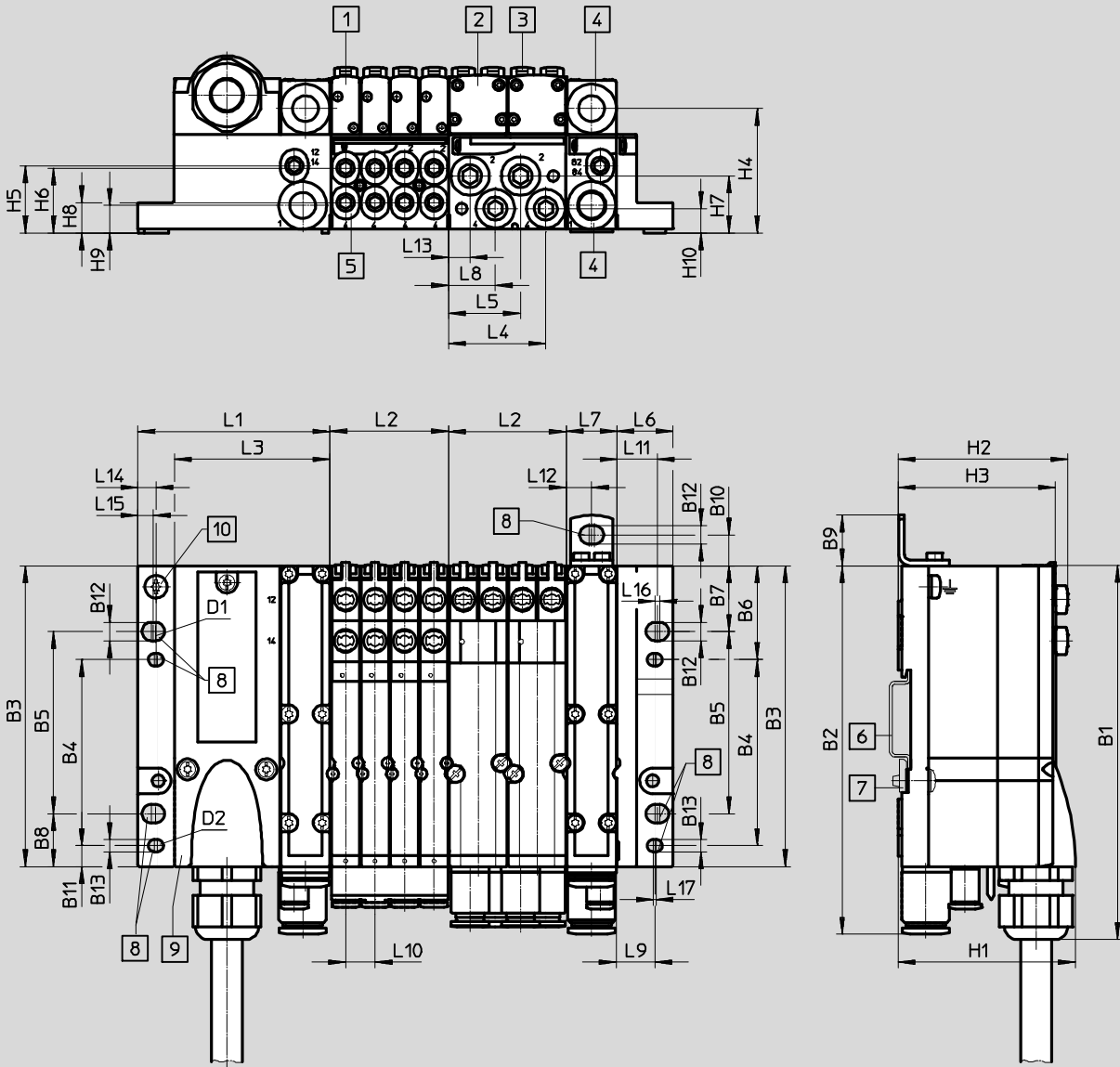

- |                        |                   |                             |  |
|------------------------|-------------------|-----------------------------|--|
| 1 Solenoid valve MPA1  | 5 Working ports   | 9 Multi-pin plug connection | n Number of sub-bases in a grid of 4 MPA1 or 2 MPA2 valves |
| 2 Solenoid valve MPA2  | 6 H-rail          | 10 Earthing screw           |  |
| 3 Manual override      | 7 H-rail mounting | 11 Electrical supply plate  |  |
| 4 Supply/exhaust ports | 8 Mounting holes  |                             |  |

Type	B1	B2	B3	B4	B5	B6	B7	B8	B9	B10	B11	B12	B13	D1	D2
MPA-S (MP)	133.3	131.4	107.3	66.3	65	33.5	23.5	18.9	18	11	7.5	6.6	4.4	M6	M4

Type	L1	L2 <sup>1)</sup>	L3	L4	L5	L6	L7	L8	L9	L10	L11	L12	L13	L14	L15	L16
MPA-S (MP)	68.8	n x 42	55.8	34.7	25.7	20	18	16.7	13.5	10.5	14.5	9	7.7	6.5	5.6	1.5

Type	L17	H1	H2	H3	H4	H5	H6	H7	H8	H9	H10
MPA-S (MP)	1	63.1	60.5	56	44.3	23.9	23.1	20.3	10.8	9.8	8.7

1) n = number of sub-bases (with MPA1, width 10 mm, max. 4 valve positions on sub-base; with MPA2, width 20 mm, max. 2 valve positions on sub-base)

# Valve terminals MPA-S

Technical data

## Dimensions

Download CAD data → [www.festo.com](http://www.festo.com)

Valve terminal with AS-interface connection

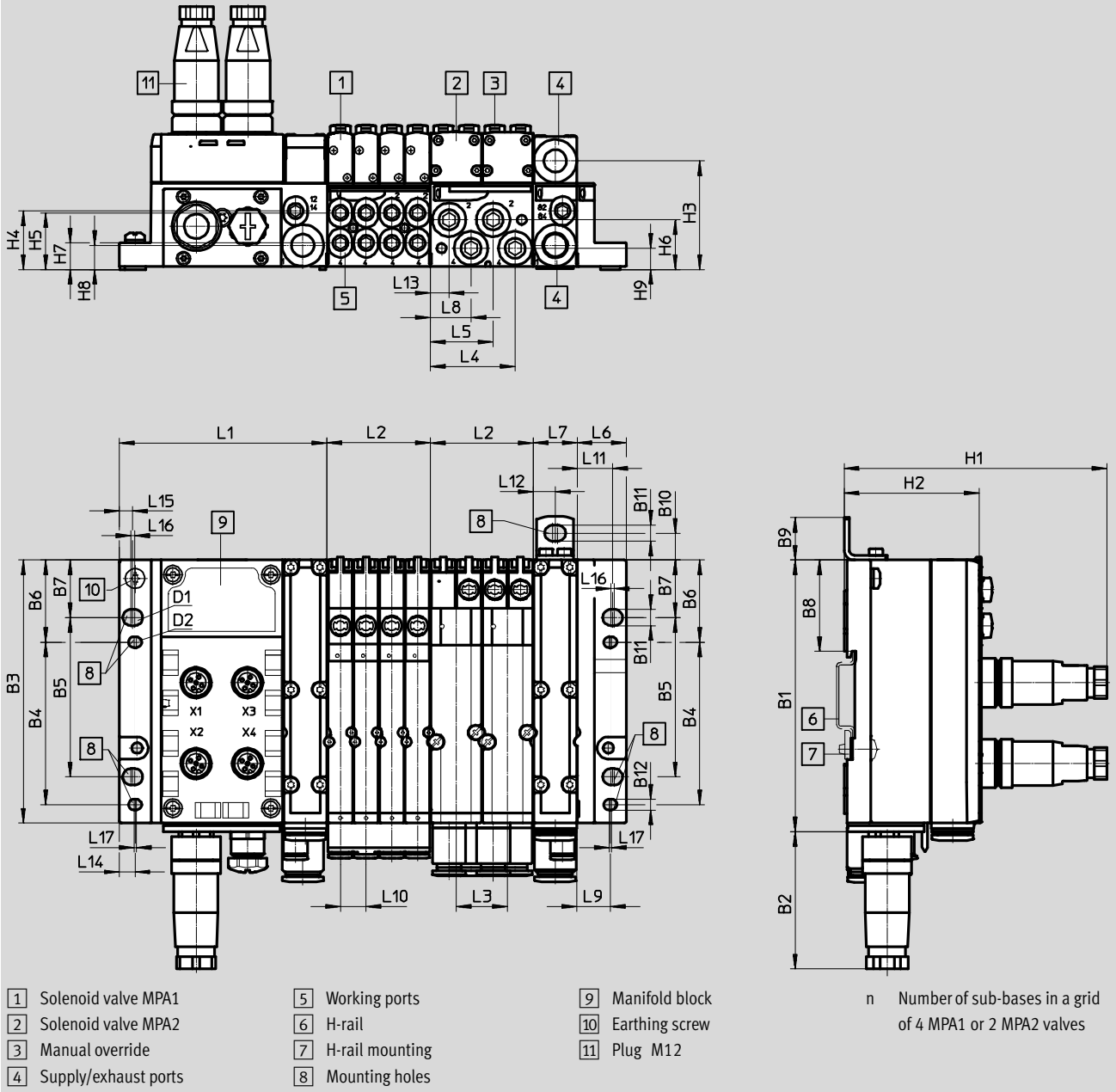

Type	B1	B2	B3	B4	B5	B6	B7	B8	B9	B10	B11	B12	D1	D2
MPA-S (AS-i)	110.9	56	107.3	66.3	65	33.5	23.5	37.2	18	11	6.6	4.4	M6	M4

Type	L1	L2 <sup>1)</sup>	L3	L4	L5	L6	L7	L8	L9	L10	L11	L12	L13	L14	L15	L16
MPA-S (AS-i)	85	n x 42	21	34.7	25.7	20	18	16.7	13.5	10.5	14.5	9	7.7	6.5	5.6	1.5

Type	L17	H1	H2	H3	H4	H5	H6	H7	H8	H9
MPA-S (AS-i)	1	107.2	55.1	44.3	23.9	23.1	20.3	10.8	9.8	8.7

1) n = number of sub-bases (with MPA1, width 10 mm, max. 4 valve positions on sub-base; with MPA2, width 20 mm, max. 2 valve positions on sub-base)

# Valve terminals MPA-S

Technical data

FESTO

## Dimensions

Download CAD data → [www.festo.com](http://www.festo.com)

Valve terminal with CPI connection

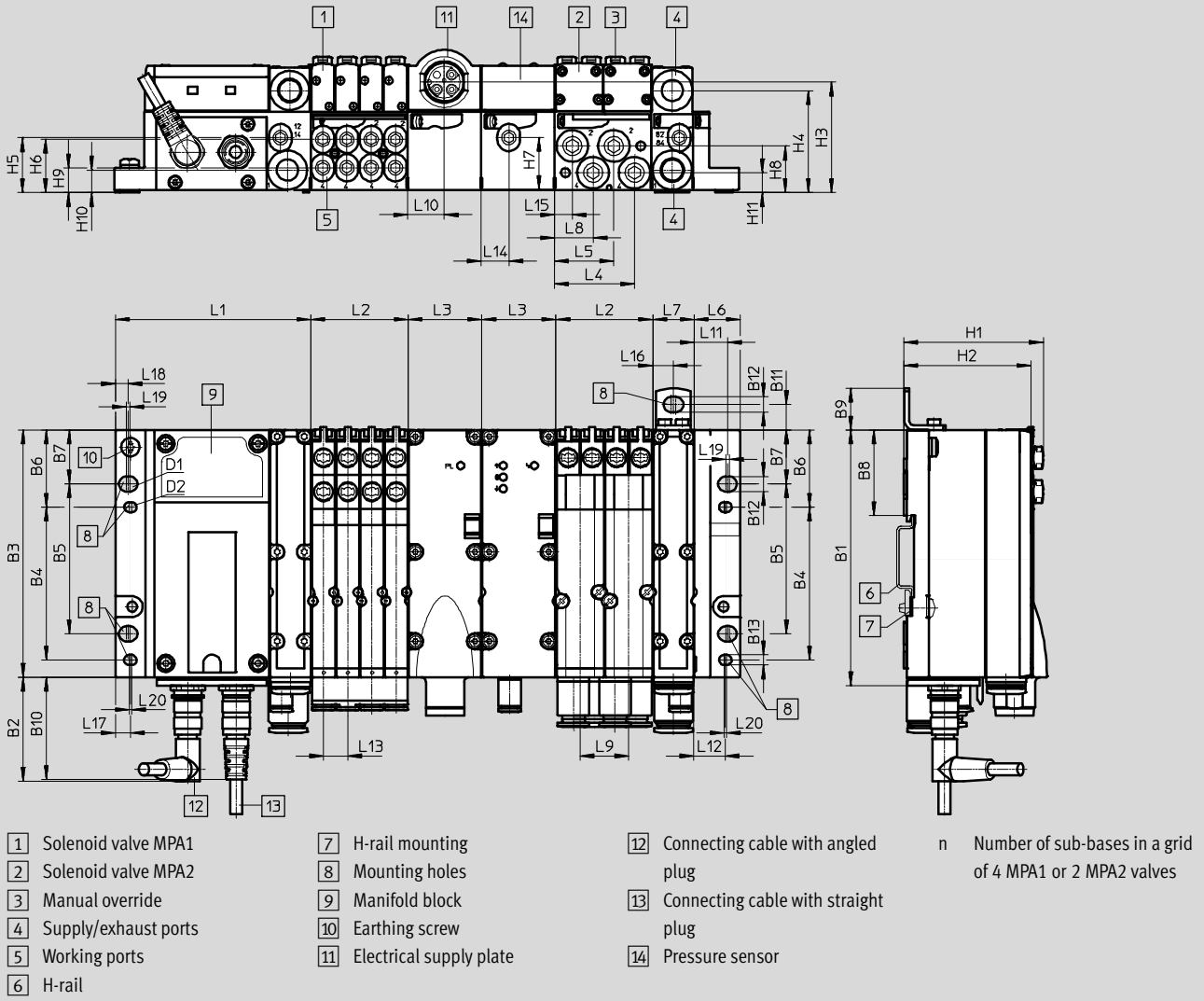

Type	B1	B2	B3	B4	B5	B6	B7	B8	B9	B10	B11	B12	B13	D1	D2
MPA-S (CPI)	110.9	45.2	107.3	66.3	65	33.5	23.5	37.2	18	44.3	11	6.6	4.4	M6	M4

Type	L1	L2 <sup>1)</sup>	L3	L4	L5	L6	L7	L8	L9	L10	L11	L12	L13	L14	L15	L16
MPA-S (CPI)	85	n x 42	32	34.7	25.7	20	18	16.7	21	16	14.5	13.5	10.5	12	7.7	9

Type	L17	L18	L19	L20	H1	H2	H3	H4	H5	H6	H7	H8	H9	H10	H11
MPA-S (CPI)	6.5	5.6	1.5	1	60.5	55.1	48	44.3	23.9	23.1	22.6	20.3	10.8	9.8	8.7

1) n = number of sub-bases (with MPA1, width 10 mm, max. 4 valve positions on sub-base; with MPA2, width 20 mm, max. 2 valve positions on sub-base)



# Valve terminals MPA-S

Technical data



## Dimensions

Download CAD data → [www.festo.com](http://www.festo.com)

Valve terminal with fieldbus connection

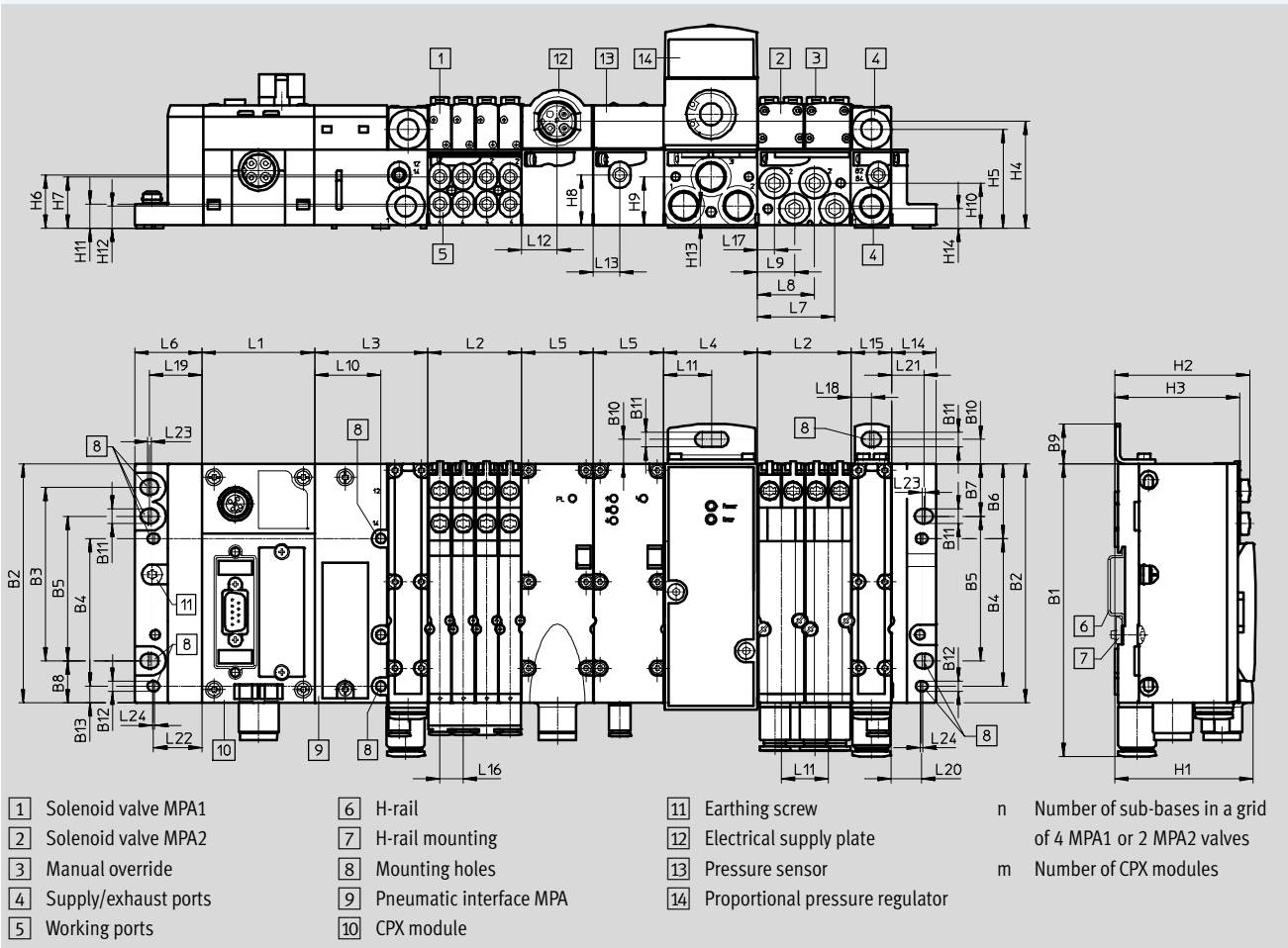

Type	B1	B2	B3	B4	B5	B6	B7	B8	B9	B10	B11	B12	B13	L1 <sup>1)</sup>	L2 <sup>2)</sup>
MPA-S (FB)	131.4	107.3	78	66.3	65	33.5	23.5	18.9	18	11	6.6	4.4	7.5	m x 50.1	n x 42

Type	L3	L4	L5	L6	L7	L8	L9	L10	L11	L12	L13	L14	L15	L16	L17	L18	L19	L20
MPA-S (FB)	51.2	42	32	30.5	34.7	25.7	16.7	30	21	16	12	20	18	10.5	7.7	9	23.7	13.5

Type	L21	L22	L23	L24	H1	H2	H3	H4	H5	H6	H7	H8	H9	H10	H11	H12	H13	H14
MPA-S (FB)	14.5	22	1.5	1	62	60.5	56	48	44.3	23.9	23.1	22.6	21.8	20.3	10.8	9.8	8.8	8.7

1) m = number of CPX modules

2) n = number of sub-bases (with MPA1, width 10 mm, max. 4 valve positions on sub-base; with MPA2, width 20 mm, max. 2 valve positions on sub-base)

# Valve terminals MPA-S

Technical data

## Dimensions

Download CAD data → [www.festo.com](http://www.festo.com)

Vertical stacking components, regulator plate VMPA1

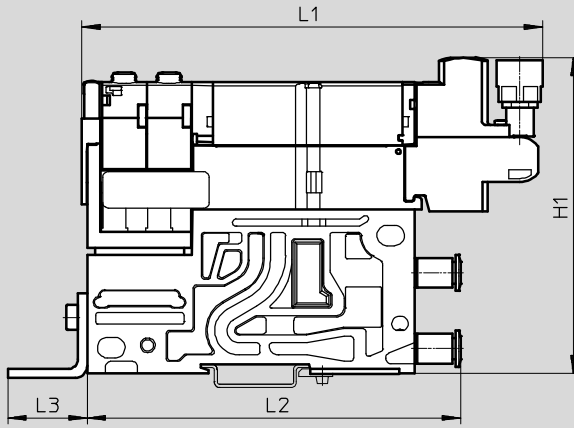

Type	H1	L1	L2	L3
VMPA1-...	105	151.1	122.3	26.9

Vertical stacking components, regulator plate VMPA2

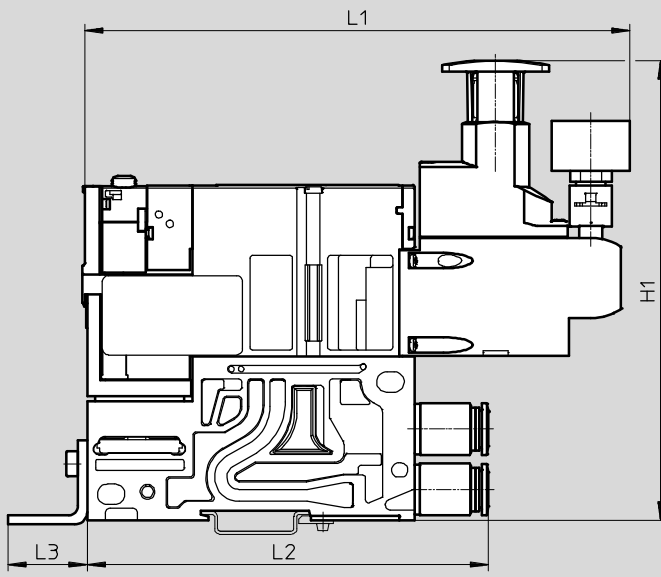





Type	H1	L1	L2	L3
VMPA2-...	152	179.6	131.6	26.9

# Valve terminals MPA-S

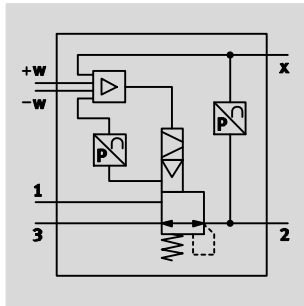
Technical data – Proportional pressure regulator VPPM

Function:





-  - Flow rate  
380 ... 1650 l/min
-  - Pressure regulation range  
0.02 ... 10 bar
-  - Voltage  
21.6 ... 26.4 V DC



General technical data			VPPM-6TA	VPPM-8TA
Valve function	3-way proportional pressure regulator			
Design	Piloted diaphragm regulator			
Type of mounting	Via through-hole or accessories			
Sealing principle	Soft			
Actuation type	Electric			
Type of control	Piloted			
Mounting position	Any			
Reset method	Mechanical spring			
Display type	LED		Back illuminated LCD	
Pneumatic connection	1, 2, 3		Sub-base	
Nominal size	Pressurisation	[mm]	6	8
	Exhaust	[mm]	4.5	7
Standard nominal flow rate	2 bar type	[l/min]	380	450
	6 bar type	[l/min]	900	1050
	10 bar type	[l/min]	1400	1650
Product weight		[g]	400	500
Materials	Housing		Anodised wrought aluminium alloy	

Electrical data		
Electrical connection	Via sub-base	
Operating voltage range	[V DC]	21.6 ... 26.4
Residual ripple	[%]	10
Max. electrical power consumption	[W]	7
Duty cycle	[%]	100
Protection against short circuit	For all electrical connections	
Reverse polarity protection	For all electrical connections	
Protection class to EN 60529	IP65	

-  - Note  
Output pressure is maintained unregulated if the power supply cable is interrupted.

-  - Note  
Note possible restrictions for the IP protection class  
➔ ATEX conformity declaration

# Valve terminals MPA-S

Technical data – Proportional pressure regulator VPPM

## Flow rate $q_{n1-2}$ from 1→2 as a function of output pressure $p_2$

VPPM-6TA-...-0L2H-... (2 bar)

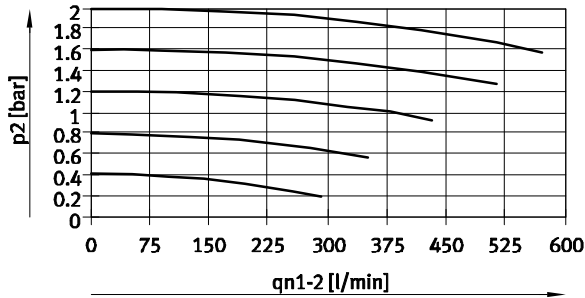

VPPM-6TA-...-0L6H-... (6 bar)

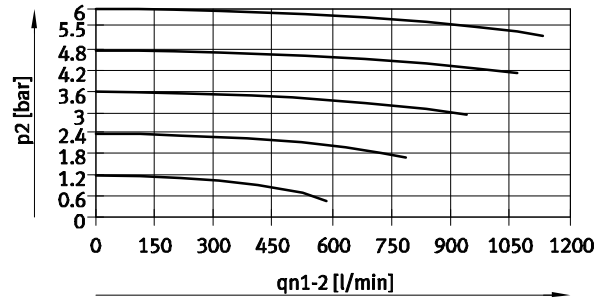

VPPM-6TA-...-0L10H-... (10 bar)

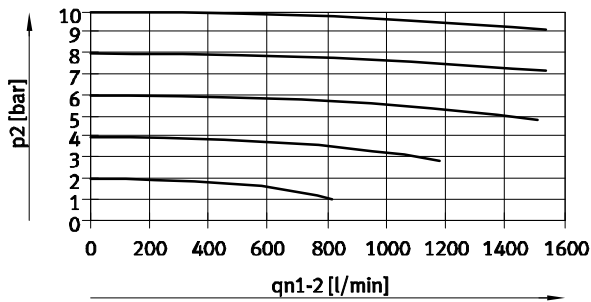

## Flow rate $q_{n2-3}$ from 2→3 as a function of output pressure $p_2$

VPPM-6TA-...-0L2H-... (2 bar)

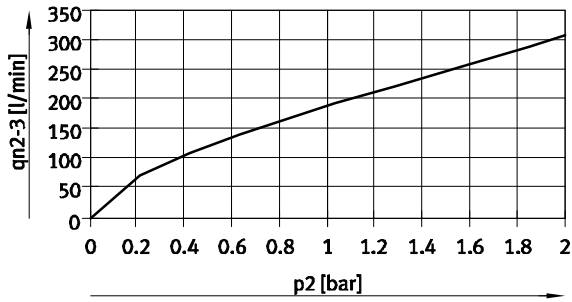

VPPM-6TA-...-0L6H-... (6 bar)

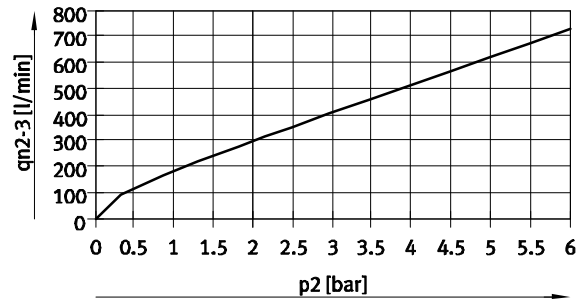

VPPM-6TA-...-0L10H-... (10 bar)

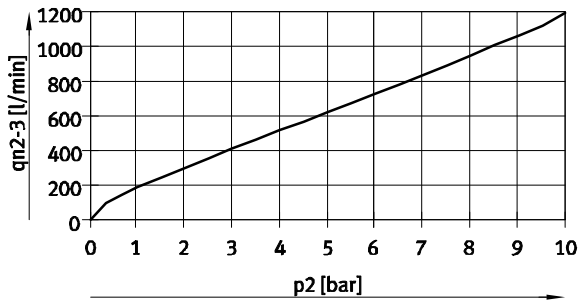

# Valve terminals MPA-S

Technical data – Proportional pressure regulator VPPM

## Flow rate $q_n$ from 1→2 as a function of output pressure $p_2$

VPPM-8TA-...-0L2H-... (2 bar)

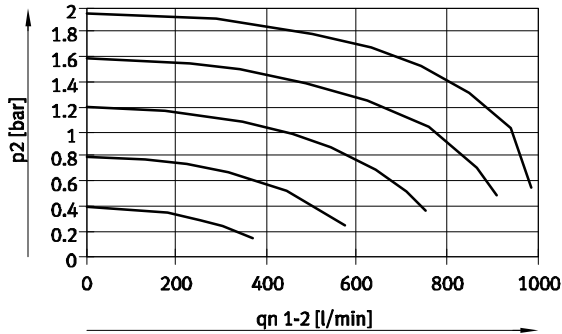

VPPM-8TA-...-0L6H-... (6 bar)

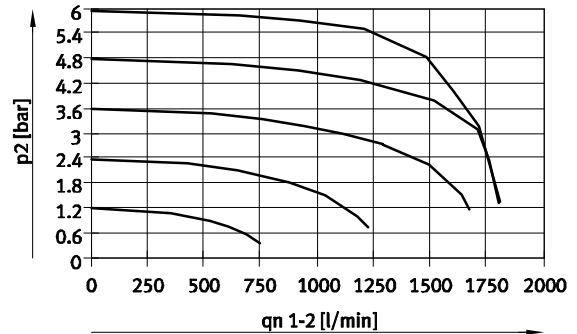

VPPM-8TA-...-0L10H-... (10 bar)

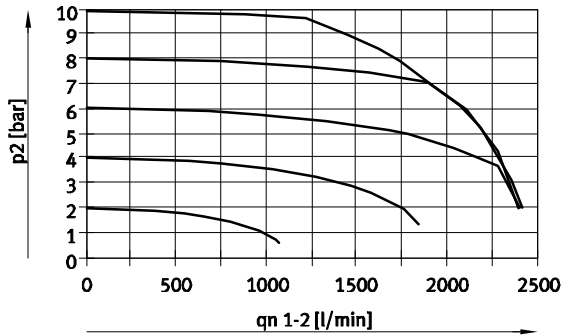

## Flow rate $q_n$ from 2→3 as a function of output pressure $p_2$

VPPM-8TA-...-0L2H-... (2 bar)

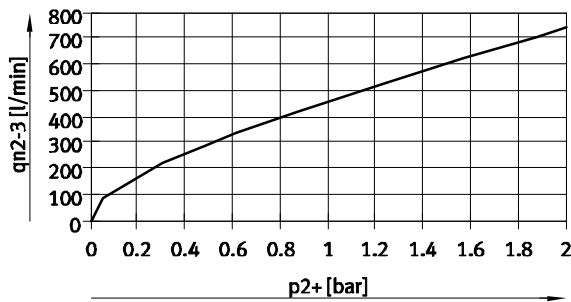

VPPM-8TA-...-0L6H-... (6 bar)



VPPM-8TA-...-0L10H-... (10 bar)

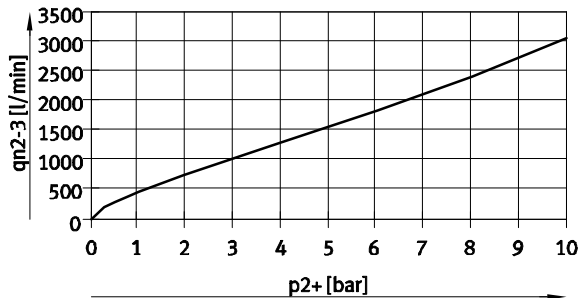

# Valve terminals MPA-S

Technical data – Proportional pressure regulator VPPM

Operating and environmental conditions			VPPM-6TA	VPPM-8TA
Operating medium			Compressed air according to ISO 8573-1:2010 [7:4:4] Inert gases	
Note on operating/pilot medium			Lubricated operation not possible	
Pressure regulation range	VPPM-...-OL2H-...	[bar]	0.02 ... 2	
	VPPM-...-OL6H-...	[bar]	0.06 ... 6	
	VPPM-...-OL10H-...	[bar]	0.1 ... 10	
Supply pressure 1 <sup>1)</sup>	VPPM-...-OL2H-...	[bar]	0 ... 4	
	VPPM-...-OL6H-...	[bar]	0 ... 8	
	VPPM-...-OL10H-...	[bar]	0 ... 11	
Max. pressure hysteresis	VPPM-...-OL2H-...	[bar]	0.01	
	VPPM-...-OL6H-...	[bar]	0.03	
	VPPM-...-OL10H-...	[bar]	0.05	
FS (full scale) linearity error	Standard	[%]	2	
	Type S1	[%]	1	
FS (full scale) repetition accuracy		[%]	0.5	
Temperature coefficient		[%/K]	0.04	
Ambient temperature		[°C]	0 ... 60	0 ... 50
Temperature of medium		[°C]	10 ... 50	
Corrosion resistance class CRC <sup>2)</sup>			2	
CE marking (see declaration of conformity)			To EU EMC Directive <sup>3)</sup>	
Certification			cULus recognized (OL)	–
			C-Tick	

- 1) Supply pressure 1 should always be 1 bar greater than the maximum regulated output pressure.
- 2) Corrosion resistance class 2 according to Festo standard 940 070  
Components subject to moderate corrosion stress. Externally visible parts with primarily decorative surface requirements which are in direct contact with a normal industrial environment or media such as coolants or lubricating agents.
- 3) For information about the applicability of the component see the manufacturer's EC declaration of conformity at: [www.festo.com/sp](http://www.festo.com/sp) → User documentation.  
If the component is subject to restrictions on usage in residential, office or commercial environments or small businesses, further measures to reduce the emitted interference may be necessary.

## LEDs on the proportional pressure regulator VPPM-6TA

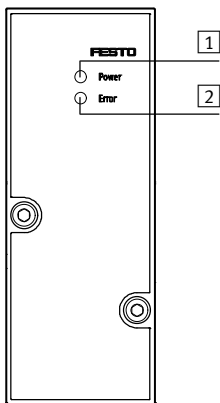

- 1 Green power LED
- 2 Red error LED

# Valve terminals MPA-S

Technical data – Proportional pressure regulator VPPM

## Dimensions

Download CAD data → [www.festo.com](http://www.festo.com)

### VPPM-6TA

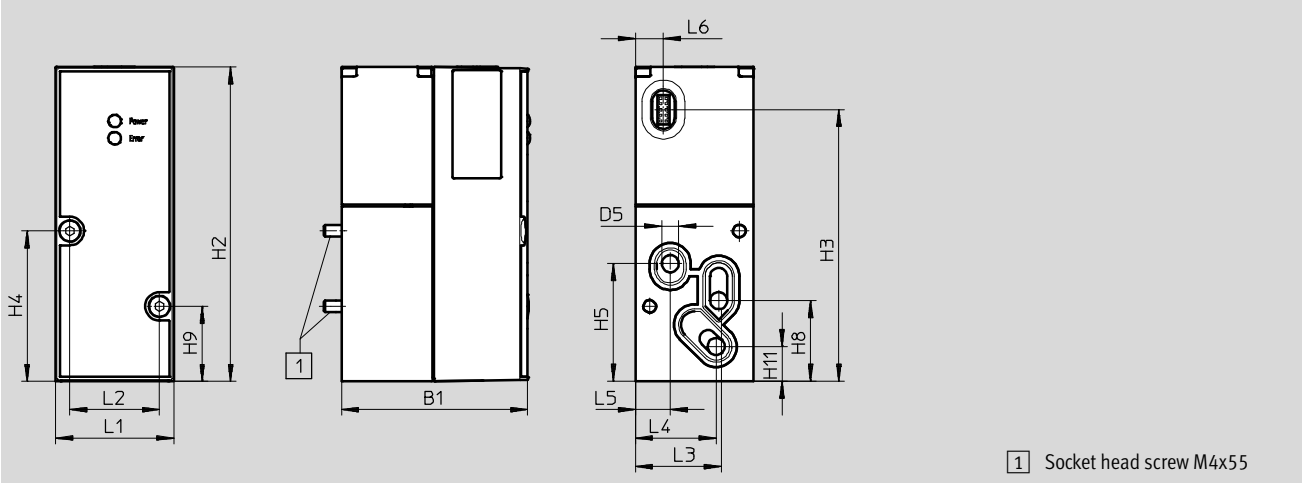

1 Socket head screw M4x55

Type	B1	D5 Ø	H2	H3	H4	H5	H8	H9	H11
VPPM-6TA	55.5	6	110.4	95.5	52.8	41.3	28.3	26.3	12.2

Type	L1	L2	L3	L4	L5	L6
VPPM-6TA	41.5	31.5	30.3	28.4	12.3	9.9

### VPPM-8TA with LCD

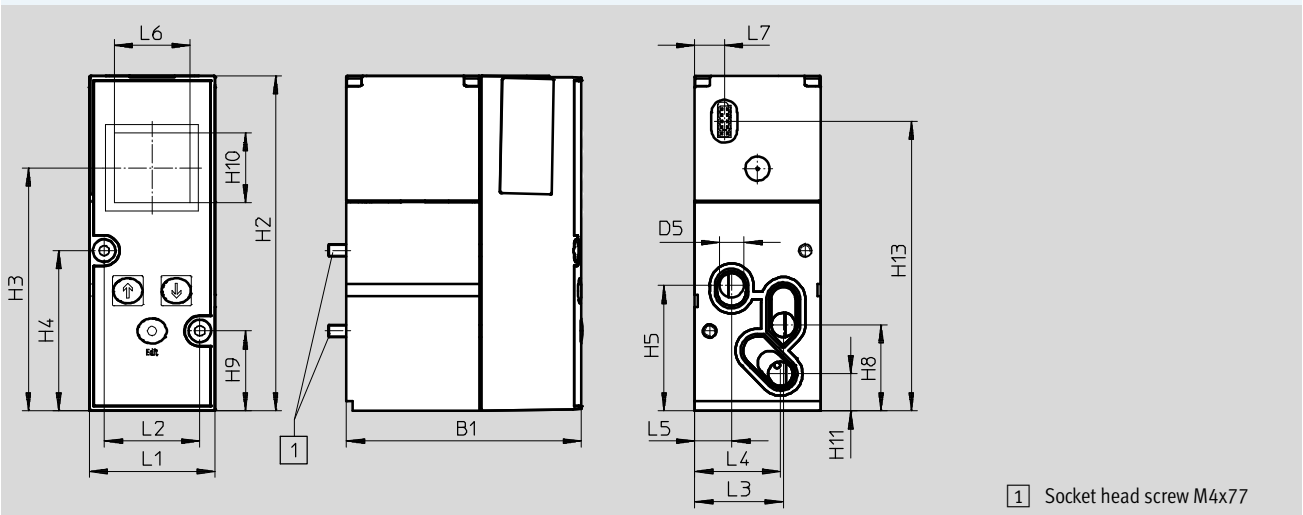

1 Socket head screw M4x77

Type	B1	D5 Ø	H2	H3	H4	H5	H8	H9	H10	H11	H13
VPPM-8TA	77.4	8	110.4	80	52.8	41.3	28.3	26.3	23	12.2	95.5

Type	L1	L2	L3	L4	L5	L6	L7
VPPM-8TA	41.5	31.5	29.3	28.4	12.3	25	9.9

# Valve terminals MPA-S

Technical data – Proportional pressure regulator VPPM

Ordering data					
Code	Overall accuracy [%]	Supply pressure 1 [bar]	Pressure regulation range [bar]	Part No.	Type
QA	2	0 ... 4	0.02 ... 2	542220	VPPM-6TA-L-1-F-0L2H
QD	1	0 ... 4	0.02 ... 2	542217	VPPM-6TA-L-1-F-0L2H-S1
QB	2	0 ... 8	0.06 ... 6	542221	VPPM-6TA-L-1-F-0L6H
QE	1	0 ... 8	0.06 ... 6	542218	VPPM-6TA-L-1-F-0L6H-S1
QC	2	0 ... 11	0.1 ... 10	542222	VPPM-6TA-L-1-F-0L10H
QF	1	0 ... 11	0.1 ... 10	542219	VPPM-6TA-L-1-F-0L10H-S1
QL	1	0 ... 4	0.02 ... 2	572407	VPPM-8TA-L-1-F-0L2H-S1C1
QG	2	0 ... 4	0.02 ... 2	572410	VPPM-8TA-L-1-F-0L2H-C1
QM	1	0 ... 8	0.06 ... 6	572408	VPPM-8TA-L-1-F-0L6H-S1C1
QH	2	0 ... 8	0.06 ... 6	572411	VPPM-8TA-L-1-F-0L6H-C1
QN	1	0 ... 11	0.1 ... 10	572409	VPPM-8TA-L-1-F-0L10H-S1C1
QK	2	0 ... 11	0.1 ... 10	572412	VPPM-8TA-L-1-F-0L10H-C1

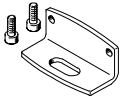
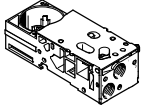
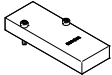
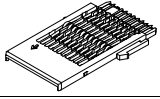
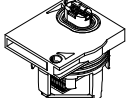
Ordering data – Accessories		
Designation	Part No.	Type
 Mounting	558844	VMPA-BG
 Sub-base without electrical interlinking module or electrical module	542223	VMPA-FB-AP-P1
 Blanking plate	559638	VMPA-P-RP
 Electrical interlinking module for sub-base of the proportional pressure regulator	537998	VMPA1-FB-EV-AB
 Electrical module	542224	VMPA-FB-EMG-P1



# Valve terminals MPA-S

Accessories



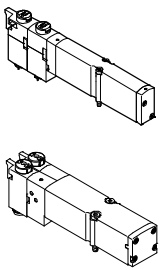



FESTO

Ordering data						
	Code	Valve function	Width [mm]	Part No.	Type	
Individual solenoid valves						
	5/2-way valve					
	M	Single solenoid	10	533342	VMPA1-M1H-M-PI	
			20	537952	VMPA2-M1H-M-PI	
	MS	Single solenoid, mechanical spring return	10	571334	VMPA1-M1H-MS-PI	
			20	571333	VMPA2-M1H-MS-PI	
	MU	Polymer poppet valve, single solenoid, mechanical spring return	10	553113	VMPA1-M1H-MU-PI	
	J	Double solenoid	10	533343	VMPA1-M1H-J-PI	
			20	537953	VMPA2-M1H-J-PI	
	2x 3/2-way valve					
	N	Normally open	10	533348	VMPA1-M1H-N-PI	
			20	537958	VMPA2-M1H-N-PI	
	NS	Normally open, mechanical spring return	10	556839	VMPA1-M1H-NS-PI	
			20	568655	VMPA2-M1H-NS-PI	
	NU	Polymer poppet valve, normally open, mechanical spring return	10	553111	VMPA1-M1H-NU-PI	
	K	Normally closed	10	533347	VMPA1-M1H-K-PI	
			20	537957	VMPA2-M1H-K-PI	
	KS	Normally closed, mechanical spring return	10	556838	VMPA1-M1H-KS-PI	
			20	568656	VMPA2-M1H-KS-PI	
	KU	Polymer poppet valve, normally closed, mechanical spring return	10	553110	VMPA1-M1H-KU-PI	
	H	1x normally open, 1x normally closed	10	533349	VMPA1-M1H-H-PI	
20			537959	VMPA2-M1H-H-PI		
HS	1x normally open, 1x normally closed, mechanical spring return	10	556840	VMPA1-M1H-HS-PI		
		20	568658	VMPA2-M1H-HS-PI		
HU	Polymer poppet valve, 1x normally open, 1x normally closed, mechanical spring return	10	553112	VMPA1-M1H-HU-PI		
5/3-way valve						
B	Mid-position pressurised	10	533344	VMPA1-M1H-B-PI		
		20	537954	VMPA2-M1H-B-PI		
G	Mid-position closed	10	533345	VMPA1-M1H-G-PI		
		20	537955	VMPA2-M1H-G-PI		
E	Mid-position exhausted	10	533346	VMPA1-M1H-E-PI		
		20	537956	VMPA2-M1H-E-PI		
3/2-way valve						
W	Normally open, external compressed air supply	10	540050	VMPA1-M1H-W-PI		
		20	540051	VMPA2-M1H-W-PI		
X	Normally closed, external compressed air supply	10	534415	VMPA1-M1H-X-PI		
		20	537961	VMPA2-M1H-X-PI		
2x 2/2-way valve						
D	Normally closed	10	533350	VMPA1-M1H-D-PI		
		20	537960	VMPA2-M1H-D-PI		
DS	Normally closed, mechanical spring return	10	556841	VMPA1-M1H-DS-PI		
		20	568657	VMPA2-M1H-DS-PI		
I	1x normally closed, 1x normally closed, reversible only	10	543605	VMPA1-M1H-I-PI		
		20	543703	VMPA2-M1H-I-PI		

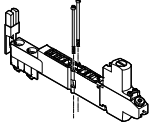
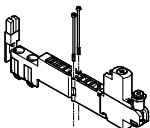
# Valve terminals MPA-S

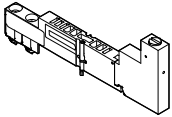







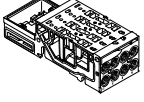

FESTO

Accessories

Ordering data – Vertical stacking modules, width 10 mm					
	Code	Description	Part No.	Type	
Pressure regulator plate, M5 interface for pressure gauge connection, fixed					
	PF	For connection 1	Pressure regulation range 0.5 ... 5 bar	564911	VMPA1-B8-R1-M5-06
	PA		Pressure regulation range 0.5 ... 8.5 bar	564908	VMPA1-B8-R1-M5-10
	PH	For connection 2	Pressure regulation range 2 ... 5 bar	564912	VMPA1-B8-R2-M5-06
	PC		Pressure regulation range 2 ... 8.5 bar	564909	VMPA1-B8-R2-M5-10
	PG	For connection 4	Pressure regulation range 2 ... 5 bar	564913	VMPA1-B8-R3-M5-06
	PB		Pressure regulation range 2 ... 8.5 bar	564910	VMPA1-B8-R3-M5-10
Pressure regulator plate, M5 interface for pressure gauge connection, rotatable					
	PF	For connection 1	Pressure regulation range 0.5 ... 5 bar	549052	VMPA1-B8-R1C2-C-06
	PA		Pressure regulation range 0.5 ... 8.5 bar	543339	VMPA1-B8-R1C2-C-10
	PH	For connection 2	Pressure regulation range 2 ... 5 bar	549053	VMPA1-B8-R2C2-C-06
	PC		Pressure regulation range 2 ... 8.5 bar	543340	VMPA1-B8-R2C2-C-10
	PG	For connection 4	Pressure regulation range 2 ... 5 bar	549054	VMPA1-B8-R3C2-C-06
	PB		Pressure regulation range 2 ... 8.5 bar	543341	VMPA1-B8-R3C2-C-10
Pressure gauge for pressure regulator plate					
	VE	M5 interface, rotatable	Operating pressure 0 ... 10 bar	Display unit 0 ... 10 bar	132340 MA-15-10-M5
	VD			Display unit 0 ... 145 psi	132341 MA-15-145-M5-PSI
Push-in fitting, self-sealing					
	–	For MPA1, M5 interface, fixed		153291	QSK-M5-4
Vertical pressure shut-off plate					
	PS	For manually disconnecting individual valves from the compressed air supply of the valve terminal (duct 1 and 12/14 pilot air supply), operating pressure 3 ... 8 bar		567805	VMPA1-HS
Fixed restrictor					
	–	Hollow bolt, for restricting the exhaust air in duct 3 and 5 (for width 10 mm only) (10 pieces)	4.5 l/min	572544	VMPA1-FT-NW0.3-10
			10.5 l/min	572545	VMPA1-FT-NW0.5-10
			20.0 l/min	572546	VMPA1-FT-NW0.7-10
			38.5 l/min	572547	VMPA1-FT-NW1.0-10
			55.0 l/min	572548	VMPA1-FT-NW1.2-10
			85.0 l/min	572549	VMPA1-FT-NW1.5-10
	110.0 l/min	572550	VMPA1-FT-NW1.7-10		
Restrictor set					
	–	Fixed restrictors, two of each size, two retainers and assembly tool		572543	VMPA1-FT-NW0.3-1.7
Retainer for fixed restrictor					
	–	Retainer for exhaust opening in the sub-base (10 pieces)		572542	VMPA1-FTI-10

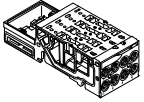
## Valve terminals MPA-S





Accessories

Ordering data – Vertical stacking modules, width 10 mm						
	Code	Description	Part No.	Type		
<b>Non-return valve</b>						
	–	Installation in duct 3 or 5 of the appropriate sub-bases (scope of delivery: 10 valve inserts, 20 balls, 20 sealing sleeves, 1 assembly tool; sufficient for 10 non-return valves)	<b>8039819</b>	<b>VMPA1-RV</b>		
<b>Sub-bases for non-return valve installation</b>						
	–	For multi-pin plug/fieldbus, four valve positions, no electrical interlinking module	No duct separation	<b>578860</b>	<b>VMPA1-FB-APF-4-1</b>	
			Duct 1 blocked	<b>578861</b>	<b>VMPA1-FB-APF-4-1-T1</b>	
			Duct 1 blocked and duct 3/5 blocked	<b>578862</b>	<b>VMPA1-FB-APF-4-1-S1</b>	
<b>Sub-bases with installed non-return valve in duct 3 and 5</b>						
	–	For multi-pin plug/fieldbus, four valve positions, no electrical interlinking module	No duct separation	<b>8034547</b>	<b>VMPA1-FB-AP-4-1-RV</b>	
			Duct 1 blocked	<b>8034549</b>	<b>VMPA1-FB-AP-4-1-T1-RV</b>	
			Duct 1 blocked and duct 3/5 blocked	<b>8034551</b>	<b>VMPA1-FB-AP-4-1-S1-RV</b>	

## Valve terminals MPA-S

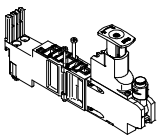
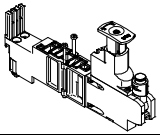
Accessories

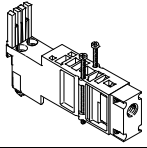
**FESTO**

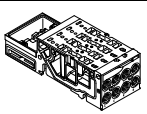
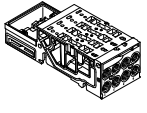
Ordering data – Vertical stacking modules, width 20 mm					
	Code	Description	Part No.	Type	
<b>Pressure regulator plate with cartridge 10 mm interface for pressure gauge connection, pressure regulator not reversible</b>					
	PF	For connection 1	Pressure regulation range 0,5 ... 5 bar	<b>549055</b>	<b>VMPA2-B8-R1C2-C-06</b>
	PA		Pressure regulation range 0,5 ... 8,5 bar	<b>543342</b>	<b>VMPA2-B8-R1C2-C-10</b>
	PH	For connection 2	Pressure regulation range 2 ... 5 bar	<b>549056</b>	<b>VMPA2-B8-R2C2-C-06</b>
	PC		Pressure regulation range 2 ... 8,5 bar	<b>543343</b>	<b>VMPA2-B8-R2C2-C-10</b>
	PG	For connection 4	Pressure regulation range 2 ... 5 bar	<b>549057</b>	<b>VMPA2-B8-R3C2-C-06</b>
	PB		Pressure regulation range 2 ... 8,5 bar	<b>543344</b>	<b>VMPA2-B8-R3C2-C-10</b>
<b>Pressure regulator plate with cartridge 10 mm interface for pressure gauge connection, pressure regulator not reversible</b>					
	PN	For connection 2	Pressure regulation range 0,5 ... 5 bar	<b>549113</b>	<b>VMPA2-B8-R6C2-C-06</b>
	PL		Pressure regulation range 0,5 ... 8,5 bar	<b>543347</b>	<b>VMPA2-B8-R6C2-C-10</b>
	PM	For connection 4	Pressure regulation range 0,5 ... 5 bar	<b>549114</b>	<b>VMPA2-B8-R7C2-C-06</b>
	PK		Pressure regulation range 0,5 ... 8,5 bar	<b>543348</b>	<b>VMPA2-B8-R7C2-C-10</b>
<b>Pressure gauge for pressure regulator plate</b>					
	T	Cartridge connection 10 mm	Operating pressure/display unit 0 ... 10 bar	<b>543488</b>	<b>PAGN-26-10-P10</b>
	-		Operating pressure/display unit 0 ... 16 bar	<b>543487</b>	<b>PAGN-26-16-P10</b>
	-		Operating pressure/display unit 0 ... 1.0 MPa	<b>563736</b>	<b>PAGN-26-1M-P10</b>
	-		Operating pressure/display unit 0 ... 1.6 MPa	<b>563735</b>	<b>PAGN-26-1.6M-P10</b>
<b>Threaded adapter for pressure regulator plate</b>					
	-	10 mm cartridge connection on thread G1/8	<b>565811</b>	<b>QSP-10-G1/8</b>	
<b>Vertical pressure supply plate</b>					
	PV	With connecting thread	G1/8	<b>8029486</b>	<b>VMPA2-VSP-0</b>
		With fitting for tubing O.D.	6 mm	<b>8035441</b>	<b>VMPA2-VSP-QS6</b>
8 mm	<b>8029488</b>		<b>VMPA2-VSP-QS8</b>		
10 mm	<b>8029489</b>		<b>VMPA2-VSP-QS10</b>		
1/4"	<b>8035442</b>		<b>VMPA2-VSP-QS1/4</b>		
5/16"	<b>8029491</b>		<b>VMPA2-VSP-QS5/16</b>		
3/8"	<b>8029492</b>		<b>VMPA2-VSP-QS3/8</b>		
<b>Non-return valve</b>					
	-	Installation in duct 3 or 5 of the appropriate sub-bases (scope of delivery: 10 non-return valves, 1 assembly tool)	<b>8039821</b>	<b>VMPA2-RV</b>	
<b>Sub-bases for non-return valve installation</b>					
	-	For multi-pin plug/fieldbus, two valve positions, no electrical interlinking module	No duct separation	<b>578863</b>	<b>VMPA2-FB-APF-2-1</b>
			Duct 1 blocked	<b>578864</b>	<b>VMPA2-FB-APF-2-1-T0</b>
			Duct 1 blocked and duct 3/5 blocked	<b>578865</b>	<b>VMPA2-FB-APF-2-1-S0</b>
<b>Sub-bases with installed non-return valve in duct 3 and 5</b>					
	-	For multi-pin plug/fieldbus, two valve positions, no electrical interlinking module	No duct separation	<b>8034548</b>	<b>VMPA2-FB-AP-2-1-RV</b>
			Duct 1 blocked	<b>8034550</b>	<b>VMPA2-FB-AP-2-1-T0-RV</b>
			Duct 1 blocked and duct 3/5 blocked	<b>8034552</b>	<b>VMPA2-FB-AP-2-1-S0-RV</b>

# Valve terminals MPA-S

Accessories

FESTO

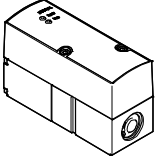
Ordering data – Proportional pressure regulator						
	Code	Full-scale linearity error	Supply pressure 1	Pressure regulation range	Part No.	Type
	QA	2%	0 ... 4 bar	0.02 ... 2 bar	542220	VPPM-6TA-L-1-F-0L2H
	QD	1%	0 ... 4 bar	0.02 ... 2 bar	542217	VPPM-6TA-L-1-F-0L2H-S1
	QB	2%	0 ... 8 bar	0.06 ... 6 bar	542221	VPPM-6TA-L-1-F-0L6H
	QE	1%	0 ... 8 bar	0.06 ... 6 bar	542218	VPPM-6TA-L-1-F-0L6H-S1
	QC	2%	0 ... 11 bar	0.1 ... 10 bar	542222	VPPM-6TA-L-1-F-0L10H
	QF	1%	0 ... 11 bar	0.1 ... 10 bar	542219	VPPM-6TA-L-1-F-0L10H-S1
	QL	1%	0 ... 4 bar	0.02 ... 2 bar	572407	VPPM-8TA-L-1-F-0L2H-S1C1
	QG	2%	0 ... 4 bar	0.02 ... 2 bar	572410	VPPM-8TA-L-1-F-0L2H-C1
	QM	1%	0 ... 8 bar	0.06 ... 6 bar	572408	VPPM-8TA-L-1-F-0L6H-S1C1
	QH	2%	0 ... 8 bar	0.06 ... 6 bar	572411	VPPM-8TA-L-1-F-0L6H-C1
	QN	1%	0 ... 11 bar	0.1 ... 10 bar	572409	VPPM-8TA-L-1-F-0L10H-S1C1
	QK	2%	0 ... 11 bar	0.1 ... 10 bar	572412	VPPM-8TA-L-1-F-0L10H-C1

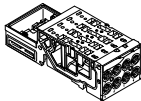
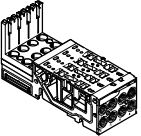
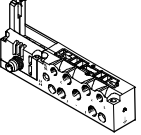
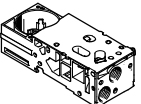
Ordering data						
Description			Width [mm]	Part No.	Type	
Sub-base – Without electrical interlinking module						
	For multi-pin plug/fieldbus	Four valve positions	10	533352	VMPA1-FB-AP-4-1	
		Two valve positions	20	538000	VMPA2-FB-AP-2-1	
	For multi-pin plug/fieldbus, duct 1 closed	Four valve positions	10	538657	VMPA1-FB-AP-4-1-T1	
		Two valve positions	20	538677	VMPA2-FB-AP-2-1-TO	
	For multi-pin plug/fieldbus, duct 1 closed and duct 3/5 closed	Four valve positions	10	555901	VMPA1-FB-AP-4-1-S1	
		Two valve positions	20	555902	VMPA2-FB-AP-2-1-SO	
Sub-base – Incl. electrical interlinking module and electronics module						
	For fieldbus	Four valve positions	10	546802	VMPA1-AP-4-1-EMS-8	
		Two valve positions	20	546803	VMPA2-AP-2-1-EMS-4	
	For multi-pin plug	Four solenoid coils	10	546806	VMPA1-AP-4-1-EMM-4	
		Two solenoid coils	20	546807	VMPA2-AP-2-1-EMM-2	
		Eight solenoid coils	10	546804	VMPA1-AP-4-1-EMM-8	
		Four solenoid coils	20	546805	VMPA2-AP-2-1-EMM-4	
Sub-base – For individual connection						
	Without ATEX specification	Internal pilot air	10	533394	VMPA1-IC-AP-1	
			20	537981	VMPA2-IC-AP-1	
		External pilot air	10	533395	VMPA1-IC-AP-S-1	
			20	537982	VMPA2-IC-AP-S-1	
	With ATEX specification: II 3G Ex nA IIC T4 XGc	Internal pilot air	10	8005149	VMPA1-IC-AP-1-EX1E	
			20	8005151	VMPA2-IC-AP-1-EX1E	
External pilot air		10	8005150	VMPA1-IC-AP-S-1-EX1E		
		20	8005152	VMPA2-IC-AP-S-1-EX1E		
Sub-base – For proportional pressure regulator						
	Without electrical interlinking module or electrical module			542223	VMPA-FB-AP-P1	

# Valve terminals MPA-S

Accessories

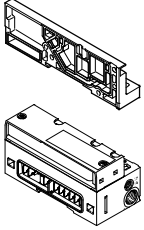
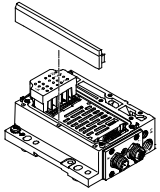
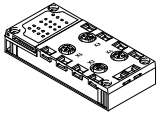
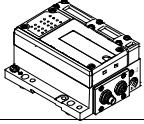
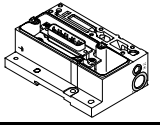
Ordering data					
Description				Part No.	Type
<b>End plate and fieldbus pneumatic interface</b>					
	Right-hand end plate		533373	VMPA-EPR	
	Right-hand end plate with port 82/84 for ducted exhaust air (connecting thread M5)		8029133	VMPA-EPR-G	
	Pneumatic interface, ducted exhaust air, internal pilot air		533370	VMPA-FB-EPL-G	
	Pneumatic interface, ducted exhaust air, internal pilot air, for CPX metal interlinking module		552286	VMPA-FB-EPLM-G	
	Pneumatic interface, ducted exhaust air, external pilot air		533369	VMPA-FB-EPL-E	
	Pneumatic interface, ducted exhaust air, external pilot air, for CPX metal interlinking module		552285	VMPA-FB-EPLM-E	
	Pneumatic interface, flat plate silencer, internal pilot air		533372	VMPA-FB-EPL-GU	
	Pneumatic interface, flat plate silencer, internal pilot air, for CPX metal interlinking module		552288	VMPA-FB-EPLM-GU	
	Pneumatic interface, flat plate silencer, external pilot air		533371	VMPA-FB-EPL-EU	
Pneumatic interface, flat plate silencer, external pilot air, for CPX metal interlinking module		552287	VMPA-FB-EPLM-EU		
<b>Electrical interface for AS-Interface</b>					
	4 inputs/4 outputs, according to spec. 2.1	Internal pilot air	Ducted exhaust air	546989	VMPA-ASI-EPL-G-4E4A-Z
			Silencer	546991	VMPA-ASI-EPL-GU-4E4A-Z
		External pilot air	Ducted exhaust air	546988	VMPA-ASI-EPL-E-4E4A-Z
			Silencer	546990	VMPA-ASI-EPL-EU-4E4A-Z
	8 inputs/8 outputs, according to spec. 2.1	Internal pilot air	Ducted exhaust air	546993	VMPA-ASI-EPL-G-8E8A-Z
			Silencer	546995	VMPA-ASI-EPL-GU-8E8A-Z
		External pilot air	Ducted exhaust air	546992	VMPA-ASI-EPL-E-8E8A-Z
			Silencer	546994	VMPA-ASI-EPL-EU-8E8A-Z
	8 inputs/8 outputs, according to spec. 3.0, extended addressing range	Internal pilot air	Ducted exhaust air	573184	VMPA-ASI-EPL-G-8E8A-CE
			Silencer	573186	VMPA-ASI-EPL-GU-8E8A-CE
		External pilot air	Ducted exhaust air	573183	VMPA-ASI-EPL-E-8E8A-CE
			Silencer	573185	VMPA-ASI-EPL-EU-8E8A-CE
<b>Connection block for AS-Interface</b>					
	M12 socket, 5-pin		195704	CPX-AB-4-M12X2-5POL	
	M8 socket, 3-pin		195706	CPX-AB-8-M8-3POL	
	Spring-loaded terminals, 32-pin		195708	CPX-AB-8-KL-4POL	
	Sub-D socket, 25-pin		525676	CPX-AB-1-SUB-BU-25POL	
	Quick connector socket, 4-pin		525636	CPX-AB-4-HAR-4POL	
<b>Electrical interface for CPI</b>					
	External pilot air, ducted exhaust air		546983	VMPA-CPI-EPL-E	
	Internal pilot air, ducted exhaust air		546984	VMPA-CPI-EPL-G	
	External pilot air, silencer		546985	VMPA-CPI-EPL-EU	
	Internal pilot air, silencer		546986	VMPA-CPI-EPL-GU	
<b>Electrical interface for multi-pin plug connection</b>					
	External pilot air, ducted exhaust air		540893	VMPA1-MPM-EPL-E	
	Internal pilot air, ducted exhaust air		540894	VMPA1-MPM-EPL-G	
	External pilot air, silencer		540895	VMPA1-MPM-EPL-EU	
	Internal pilot air, silencer		540896	VMPA1-MPM-EPL-GU	

# Valve terminals MPA-S

Accessories



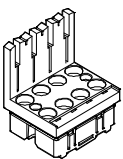
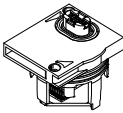
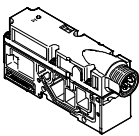
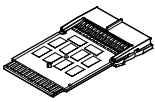
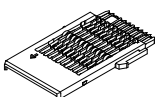

FESTO

Ordering data						
Description		Width [mm]	Part No.	Type		
<b>Electronics module</b> For fieldbus connection						
	Without separate circuit	4 coils	20	537983	VMPA2-FB-EMS-4	
		8 coils	10	533360	VMPA1-FB-EMS-8	
	With separate circuit	4 coils	20	537984	VMPA2-FB-EMG-4	
		8 coils	10	533361	VMPA1-FB-EMG-8	
	For fieldbus connection with extended diagnostic function					
	Without separate circuit	4 coils	20	543332	VMPA2-FB-EMS-D2-4	
		8 coils	10	543331	VMPA1-FB-EMS-D2-8	
	With separate circuit	4 coils	20	543334	VMPA2-FB-EMG-D2-4	
		8 coils	10	543333	VMPA1-FB-EMG-D2-8	
	For multi-pin plug connection					
	Modular (MPM)	2 coils	20	537985	VMPA2-MPM-EMM-2	
		4 coils	20	537986	VMPA2-MPM-EMM-4	
4 coils		10	537987	VMPA1-MPM-EMM-4		
8 coils		10	537988	VMPA1-MPM-EMM-8		
<b>Electrical module</b>						
	For proportional pressure regulator			542224	VMPA-FB-EMG-P1	
<b>Electrical supply plate</b>						
	Plug connection M18, 3-pin			541082	VMPA-FB-SP-V	
	Plug connection 7/8", 5-pin			541083	VMPA-FB-SP-7/8-V-5POL	
	Plug connection 7/8", 4-pin			541084	VMPA-FB-SP-7/8-V-4POL	
<b>Electrical interlinking module for multi-pin plug connection and AS-Interface</b>						
	For a sub-base	2 coils	20	537989	VMPA2-MPM-EV-AB-2	
		4 coils	10	537993	VMPA1-MPM-EV-AB-4	
		8 coils	10	537994	VMPA1-MPM-EV-AB-8	
	For a sub-base with pneumatic supply plate (on the left next to the sub-base)	2 coils	20	537991	VMPA2-MPM-EV-ABV-2	
		4 coils	10	537995	VMPA1-MPM-EV-ABV-4	
		8 coils	10	537996	VMPA1-MPM-EV-ABV-8	
<b>Electrical interlinking module for fieldbus connection and CPI</b>						
	For sub-bases MPA size 1 and 2, and proportional pressure regulators		10 20	537998	VMPA1-FB-EV-AB	
	For a pneumatic supply plate			537999	VMPA1-FB-EV-V	

# Valve terminals MPA-S

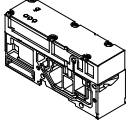
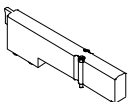
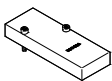
Accessories

FESTO

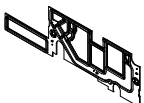
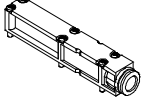
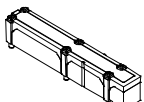
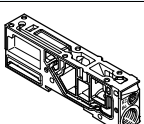
Ordering data				
Description		Part No.	Type	
<b>Pressure sensors</b>				
	For monitoring the operating pressure in duct 1	541085	VMPA-FB-PS-1	
	For monitoring the pressure in exhaust ducts 3 and 5	541086	VMPA-FB-PS-3/5	
	For monitoring an external process pressure	541087	VMPA-FB-PS-P1	
<b>Cover</b>				
	Blanking plate for valve position <sup>1)</sup>	533351	VMPA1-RP	
		537962	VMPA2-RP	
	Cover plate	559638	VMPA-P-RP	
	Cover cap for manual override with coded cover cap, manual override non-detenting (x10)	540897	VMPA-HBT-B	
	Cover cap for manual override, covered, manual override blocked (x10)	540898	VMPA-HBV-B	
	Cover cap for manual override, manual override detenting, can be operated manually without accessories (x10)	8002234	VAMC-L1-CD	
	Inscription label holder for an inscription label and a cover for the switching status indication and the manual override (blocked) (x10)	570818	ASLR-D-L1	
<b>Seal for manifold block</b>				
	MPA with ducted exhaust air	No duct separation	533359	VMPA1-DP
		Duct 1 separated	533363	VMPA1-DP-P
		Duct 3/5 separated	533364	VMPA1-DP-RS
		Duct 1 and 3/5 separated	533365	VMPA1-DP-PRS
	MPA with flat plate silencer	No duct separation	533355	VMPA1-DPU
		Duct 1 separated	533356	VMPA1-DPU-P
		Duct 3/5 separated	533357	VMPA1-DPU-RS
		Duct 1 and 3/5 separated	533358	VMPA1-DPU-PRS
<b>Exhaust plate</b>				
	Ducted exhaust air, with 10 mm push-in connector	533375	VMPA-AP	
	Ducted exhaust air, with QS-3/8 connector	541629	VMPA-AP-3/8	
	Flat plate silencer	533374	VMPA-APU	
<b>Supply plate (without exhaust plate)</b>				
	For ducted exhaust air	533354	VMPA1-FB-SP	
	For flat plate silencer	533353	VMPA1-FB-SPU	



1) A self-adhesive label is supplied.



# Valve terminals MPA-S

Accessories

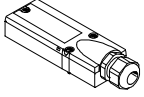
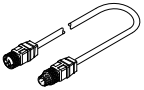
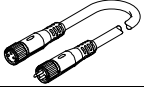



**FESTO**

Ordering data				
Description		Part No.	Type	
<b>Multi-pin plug connection, electrical</b>				
	Cover without connecting cable for self-assembly	<b>533198</b>	<b>VMPA-KMS-H</b>	
	PVC connecting cable for 8 solenoid coils	2.5 m	<b>533195</b>	<b>VMPA-KMS1-8-2,5</b>
		5 m	<b>533196</b>	<b>VMPA-KMS1-8-5</b>
		10 m	<b>533197</b>	<b>VMPA-KMS1-8-10</b>
	PVC connecting cable for 24 solenoid coils	2.5 m	<b>533192</b>	<b>VMPA-KMS1-24-2,5</b>
		5 m	<b>533193</b>	<b>VMPA-KMS1-24-5</b>
		10 m	<b>533194</b>	<b>VMPA-KMS1-24-10</b>
	PUR connecting cable for 8 solenoid coils, suitable for energy chains	2.5 m	<b>533504</b>	<b>VMPA-KMS2-8-2,5-PUR</b>
		5 m	<b>533505</b>	<b>VMPA-KMS2-8-5-PUR</b>
		10 m	<b>533506</b>	<b>VMPA-KMS2-8-10-PUR</b>
	PUR connecting cable for 24 solenoid coils, suitable for energy chains	2.5 m	<b>533501</b>	<b>VMPA-KMS2-24-2,5-PUR</b>
		5 m	<b>533502</b>	<b>VMPA-KMS2-24-5-PUR</b>
10 m		<b>533503</b>	<b>VMPA-KMS2-24-10-PUR</b>	
<b>Connecting cable, AS-Interface connection</b>				
	<ul style="list-style-type: none"> <li>• Straight socket, M12x1, 5-pin, A-coded</li> <li>• Straight plug connector, M12x1, 4-pin, A-coded</li> </ul>	0.2 m	<b>542129</b> <b>NEBU-M12G5-F-0.2-M12G4</b>	
	Modular system for connecting cables	–	→ Internet: nebu	
<b>Connecting cable, CPI connection</b>				
	<ul style="list-style-type: none"> <li>• Angled plug connector, 5-pin</li> <li>• Angled socket, 5-pin</li> </ul>	0.25 m	<b>540327</b> <b>KVI-CP-3-WS-WD-0,25</b>	
		0.5 m	<b>540328</b> <b>KVI-CP-3-WS-WD-0,5</b>	
		2 m	<b>540329</b> <b>KVI-CP-3-WS-WD-2</b>	
		5 m	<b>540330</b> <b>KVI-CP-3-WS-WD-5</b>	
		8 m	<b>540331</b> <b>KVI-CP-3-WS-WD-8</b>	
	<ul style="list-style-type: none"> <li>• Straight plug connector, 5-pin</li> <li>• Straight socket, 5-pin</li> </ul>	2 m	<b>540332</b> <b>KVI-CP-3-GS-GD-2</b>	
		5 m	<b>540333</b> <b>KVI-CP-3-GS-GD-5</b>	
		8 m	<b>540334</b> <b>KVI-CP-3-GS-GD-8</b>	

# Valve terminals MPA-S

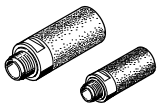
FESTO

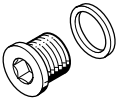





Accessories

Ordering data		Part No.	Type
Description			
Push-in fitting for manifold block, pneumatic interface, supply plate			
	Connecting thread M5 for tubing O.D.	3 mm (10 pieces)	153313 QSM-M5-3-I
		4 mm (10 pieces)	153315 QSM-M5-4-I
		6 mm (10 pieces)	153317 QSM-M5-6-I
		5/32" (1 piece)	130593 QSM-M5-5/32-I-U-M
		3/16" (1 piece)	183750 QSM-M5-3/16-I-U-M
		1/4" (50 pieces)	130591 QSM-M5-1/4-I-U-M
	Connecting thread M7 for tubing O.D.	4 mm (10 pieces)	153319 QSM-M7-4-I
		6 mm (10 pieces)	153321 QSM-M7-6-I
		3/16" (1 piece)	183739 QSM-M7-3/16-I-U-M
		1/4" (50 pieces)	183740 QSM-M7-1/4-I-U-M
	Connecting thread G $\frac{1}{8}$ for tubing O.D.	6 mm (10 pieces)	186107 QS-G $\frac{1}{8}$ -6-I
		8 mm (10 pieces)	186109 QS-G $\frac{1}{8}$ -8-I
		1/4" (1 piece)	183741 QS-1/8-1/4-I-U-M
		5/16" (1 piece)	183742 QS-1/8-5/16-I-U-M
	Connecting thread G $\frac{1}{4}$ for tubing O.D.	8 mm (10 pieces)	186110 QS-G $\frac{1}{4}$ -8-I
		10 mm (10 pieces)	186112 QS-G $\frac{1}{4}$ -10-I
5/16" (1 piece)		183743 QS-1/4-5/16-I-U-M	
3/8" (1 piece)		183744 QS-1/4-3/8-I-U-M	
Silencer			
	Connecting thread	M5 (1 piece)	165003 UC-M5
		M7 (1 piece)	161418 UC-M7
		G $\frac{1}{4}$ (1 piece)	165004 UC- $\frac{1}{4}$
		G $\frac{1}{8}$ (1 piece)	161419 UC- $\frac{1}{8}$
	Push-in sleeve connection	3 mm (1 piece)	165005 UC-QS-3H
		4 mm (1 piece)	165006 UC-QS-4H
		6 mm (1 piece)	165007 UC-QS-6H
		8 mm (1 piece)	175611 UC-QS-8H
		10 mm (1 piece)	526475 UC-QS-10H
Blanking plug			
	Thread M5 (10 pieces)	3843	B-M5
		Thread M7 (10 pieces)	174309
G $\frac{1}{8}$ thread (10 pieces)		3568	B- $\frac{1}{8}$
Thread G $\frac{1}{4}$ (10 pieces)		3569	B- $\frac{1}{4}$
Plug			
	Blanking plug for tubing O.D. (10 pieces)	4 mm	153267 QSC-4H
		6 mm	153268 QSC-6H
		8 mm	153269 QSC-8H
		10 mm	153270 QSC-10H
		3/16"	564785 QBC-3/16H-U
		1/4"	564786 QBC-1/4H-U
		5/16"	564787 QBC-5/16H-U
		3/8"	564788 QBC-3/8H-U

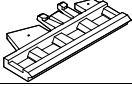
# Valve terminals MPA-S

Accessories

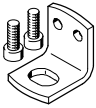
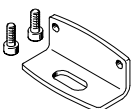
**FESTO**

Ordering data			
Description		Part No.	Type
<b>Inscription labels</b>			
	Inscription label holder for manifold block, transparent, for paper label	<b>533362</b>	<b>VMPA1-ST-1-4</b>
	Inscription label holder for manifold block, 4-fold, for IBS-6x10	<b>544384</b>	<b>VMPA1-ST-2-4</b>
	Inscription labels 6 x 10 in frame, 64 pieces	<b>18576</b>	<b>IBS-6x10</b>
	Inscription label holder for an inscription label and a cover for the manual override, 10 pieces	<b>570818</b>	<b>ASLR-D-L1</b>
<b>Mounting</b>			
	For H-rail	<b>526032</b>	<b>CPX-CPA-BG-NRH</b>
	Mounting (for supply plate)	<b>534416</b>	<b>VMPA-BG-RW</b>
	Mounting (for proportional pressure regulator sub-base)	<b>558844</b>	<b>VMPA-BG</b>
<b>User Documentation</b>			
	MPA pneumatic components	German	<b>534240</b> <b>P.BE-MPA-DE</b>
		English	<b>534241</b> <b>P.BE-MPA-EN</b>
		French	<b>534243</b> <b>P.BE-MPA-FR</b>
		Spanish	<b>534242</b> <b>P.BE-MPA-ES</b>
		Italian	<b>534244</b> <b>P.BE-MPA-IT</b>
	MPA electronic components description (pneumatic modules, pressure sensors, proportional pressure regulators, etc.)	German	<b>562112</b> <b>P.BE-MPA-Elektronik-DE</b>
		English	<b>562113</b> <b>P.BE-MPA-Elektronik-EN</b>
		French	<b>562115</b> <b>P.BE-MPA-Elektronik-FR</b>
		Spanish	<b>562114</b> <b>P.BE-MPA-Elektronik-ES</b>
		Italian	<b>562116</b> <b>P.BE-MPA-Elektronik-IT</b>