

Modular electrical peripherals, for type 03/04

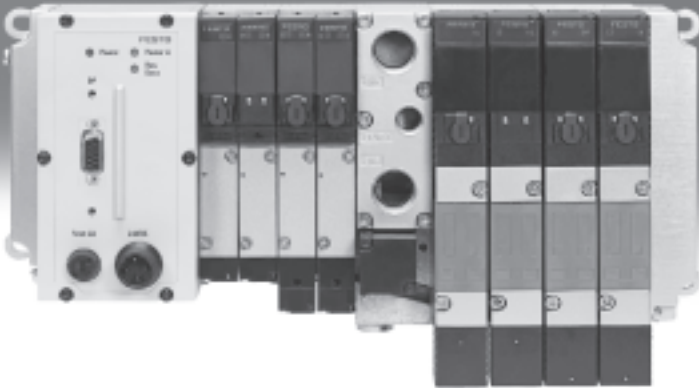

- 1 - Type discontinued
Available up until 2017

Modular electrical peripherals, for type 03/04

Key features

FESTO

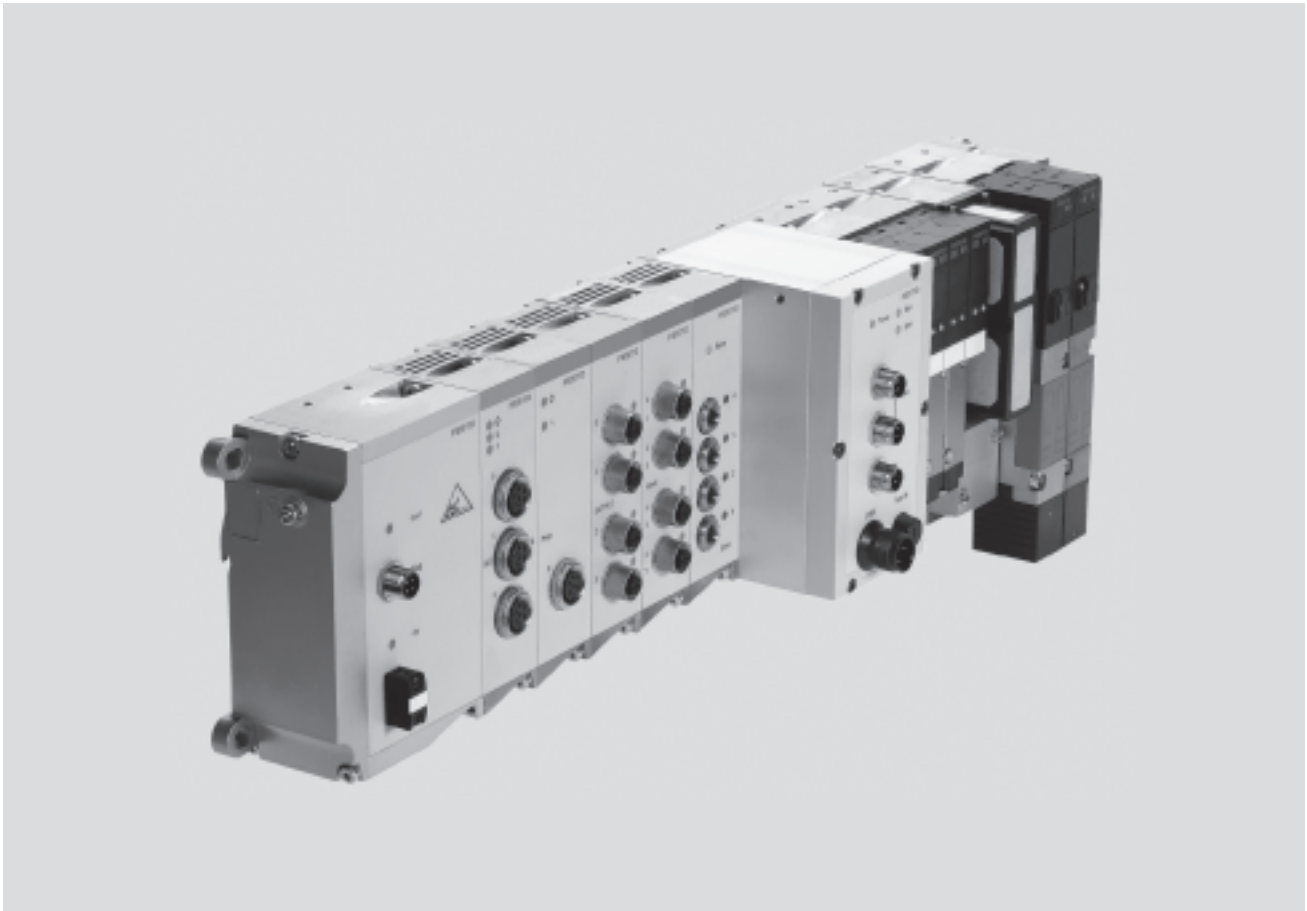

Innovative

- First modular valve terminal on the market with modular electrical peripherals
- Standardised from the individual midi valve up to multi-pin and fieldbus connections
- First programmable valve terminal with integrated controller
- Digital I/O modules, either PNP switching
- Analogue I/O in the field for short lines
- Special modules for control desks
- Interfaces for subordinate, decentralised installation systems

Modular

- Modular system offering a range of configuration options
- Expandable up to 26 solenoid coils
- Conversions and extensions are possible at any time
- Connection blocks can be extended using 3 screws M4x14
- Modular electrical peripherals with digital and analogue I/Os
- High pressure range

Reliable

- Sturdy and durable metal components
 - I/O modules
 - Connection technology
 - Valves
 - Connection blocks
- Fast troubleshooting thanks to LEDs on the valves and I/O modules
- Diagnosis using fieldbus
- Pre-assembled cables for all I/O modules
- Reliability of service through replaceable valves and modules

Easy to assemble

- Ready to install unit, already assembled and tested
- Lower costs for selection, ordering, assembly and commissioning
- Secure wall mounting or via H-rail

Modular electrical peripherals, for type 03/04

Key features

Modular electrical peripherals for valve terminal type 03/04

Modular electrical peripherals provide the required control technology for type 03 (MIDI/MAXI) valve terminals. Together these components form the most comprehensive system range in intelligent pneumatics and also offer the advantage of a sturdy metal design.

As well as incorporating protection class IP65, the system also provides benefits through the sturdy design of its modules and connections. Individual modules are enclosed in metal housings with push-in fittings, and are made primarily of steel. The connections between the modules are protected by special seals and each connection point is secured using 3 robust M4x14 DIN 912 screws.

The main industrial fieldbuses are used for networking and control. Directly integrated programmable controllers (PLC) with fieldbus interface from Festo can also be used for actuation. The module also offers various actuation and connection options for machine control.

Ongoing further development and a worldwide service and consultation network round off the performance spectrum for this system.



Note

Use the menu-driven online configurator for modular electrical peripherals type 03/04 and valve terminal in the electronic catalogue on www.festo.com.

Type 03 with fieldbus connection

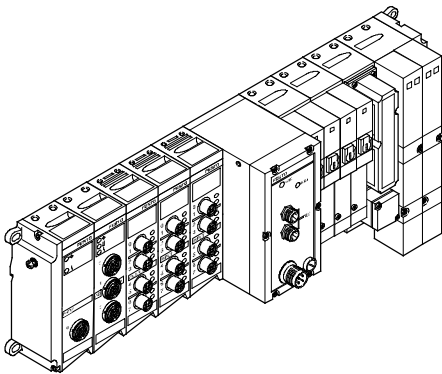

Ordering

Modular electrical peripherals type 03/04 and valve terminal are fully assembled according to your order specifications and individually tested. The finished valve terminal consists of the electrical peripherals including the required actuator and the selected components of the MIDI/MAXI or ISO modules.

Modular electrical peripherals type 03/04 with valve terminal are ordered using two separate order codes. One order code defines the modular electrical peripherals type 03/04, while the other specifies the pneumatic components of the valve terminal.

Modular electrical peripherals type 03/04 can naturally also be configured without a valve terminal as a remote I/O and can be used on a fieldbus or with an integrated controller. For this order, you only require the order code for the electrical peripherals.

The order lists for the modular electrical peripherals type 03/04 can be found in this chapter. For information on how to order the pneumatic components see:
→ Internet: midi/maxi

- 1 - Type discontinued
Available up until 2017

FESTO

Modular electrical peripherals, for type 03/04

Key features – General

Performance characteristics

Control block, fieldbus connection, multi-pin connection

Optimising and extending applications:

- Modules for installation-saving connection using sturdy Sub-D plugs in IP65
- Low-cost connections to input/output stations and control units
- Extensions and supplements can be added at any time

Easy mounting:

- On H-rail
- On mounting surface
- With covers in welding environments

Simple servicing and maintenance:

- LED display
- Manual override
- Clip-on inscription labels

Input/output modules

Flexible for control systems thanks to an extensive range of connection nodes:

- Multi-pin connection
- Fieldbus connection

Proportional pneumatics:

- To detect, control/regulate universal variables (4 ... 20 mA or 0 ... 10 V DC) within the process – locally to IP65

Electrical digital inputs/outputs:

- Max. 12 modules in conjunction with suitable nodes
- Inputs for 24 V DC sensors, PNP
- Outputs for small-load power consumers 24 V DC

Types of pneumatic valve terminals supported

Type 03 – MIDI/MAXI valve terminals

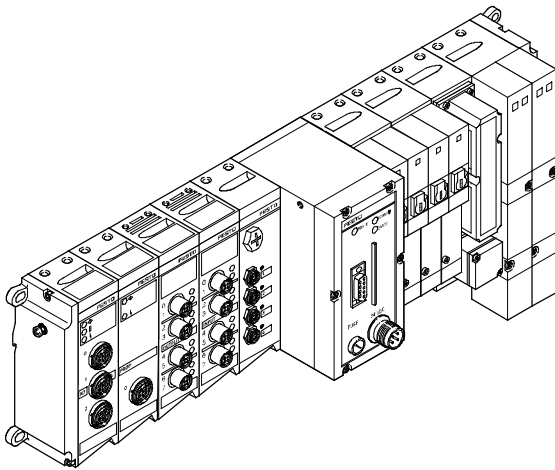

General functions of the bus nodes and control blocks

A bus node or control block is at the heart of the modular electrical peripheral system. They manage the communication connection to higher-order controllers and master interfaces and a PLC program with a full range of additional functions is executed directly in the control block. The power supply for the I/O modules and the sensors connected to them is provided by means of the bus node or control

block, as is the load supply for the solenoid coils and the electronic outputs.

System monitoring and diagnosis are further important functions of the bus node or control block. The diagnostics are composed of three elements:

- Device-specific information displayed directly on the bus node or control block by means of LEDs.

- Device-specific status bits that are transferred to the control program via the network.
- Protocol-specific diagnoses.

The bus nodes or control blocks collect the most important diagnostic data in the status bits and transfer it to the higher-order controller as logical inputs.

Suitable further processing functions

in the control program provide helpful information on the status of the power supply, short circuits and overload (with some of this information relating to specific modules or channels). Further protocol and node-specific diagnostic services are described in conjunction with the individual I/O modules, bus nodes and control blocks.

Modular electrical peripherals, for type 03/04

Key features – Electrical components

Supply voltage

The entire power supply for the system and the sensors and actuators connected to it is provided via an M18 mains plug.

The power supply for the electrical peripherals type 03 and 04 is split in two.

Pin 1 of the mains plug provides the

sensor supply for the input modules and supplies the internal electronics of the individual modules.

The sensor supply is protected separately from the electronics supply in the node by means of a 2 A fuse. We recommend that pin 1 be additionally protected against short circuit/over-

load by means of a 3.15 A external fuse.

Pin 2 of the mains plug provides the load supply for solenoid coil actuation and the electrical 24 V DC outputs.

The load supply must be externally protected against short circuit and

overload by means of a 10 A strong fuse.

The load voltage of the valves and electrical outputs can be disconnected separately. The common 0 V line is connected to pin 3. Pin 4 serves as an earth terminal.

Example of circuit

Connection of a common 24 V DC power supply and the protective earth (type 03 used in the example)

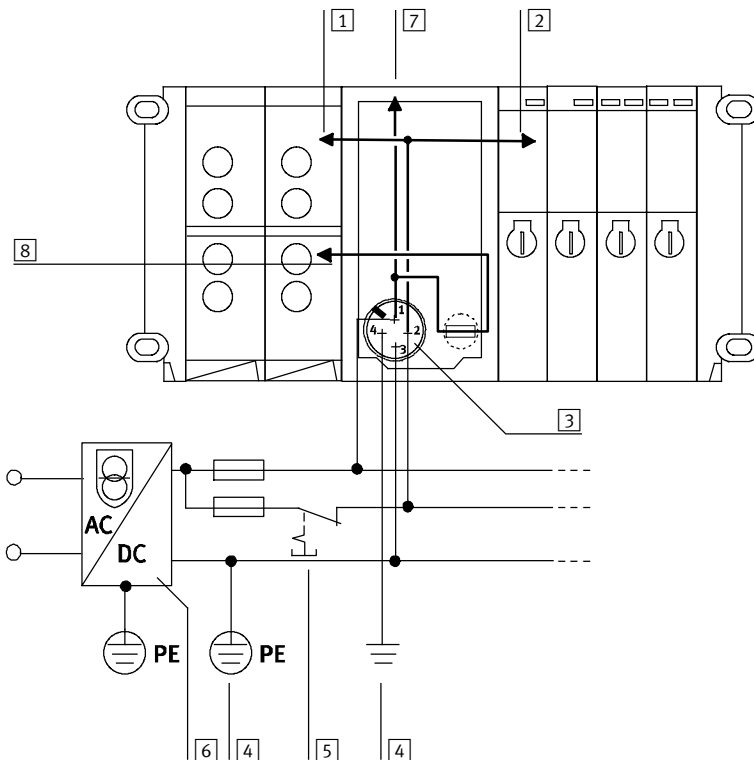

- 1 Electrical outputs (externally fused)
- 2 Valves
- 3 Voltage supply connection for node type 03
- 4 Potential equalisation
- 5 Load voltage, can be disconnected separately
- 6 Power supply unit (e.g. central voltage supply)
- 7 24 V DC electronics
- 8 Electrical inputs/sensors

Pin allocation

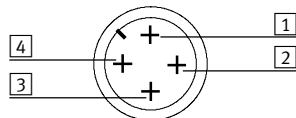
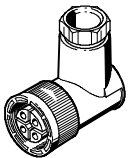

- 1 24 V DC supply for electronics and inputs
- 2 24 V DC load supply for valves
- 3 0 V
- 4 Earth terminal

Modular electrical peripherals, for type 03/04

Key features – Diagnosis

General system diagnosis		
Diagnostic information	Description	Function
Short circuit/overload at output	Output has short-circuited or become overloaded	Monitors the electrical outputs of the output modules
$V_{\text{Valves}} < 21.6 \text{ V DC}$	Load voltage at pin 2 (valves and outputs) of the operating voltage connection $< 21.6 \text{ V DC}$	Monitors the tolerance of the load voltage for valves and electrical outputs
$V_{\text{Outputs}} < 10 \text{ V DC}$	Load voltage at pin 2 (valves and outputs) of the operating voltage connection $< 10 \text{ V DC}$	Monitors the load voltage for valves and electrical outputs (no voltage, e.g. EMERGENCY-STOP)
$V_{\text{Sensor}} < 10 \text{ V DC}$	Operating voltage at pin 1 (electronics and inputs) of the operating voltage connection $< 10 \text{ V DC}$	Monitors the operating voltage for inputs (sensors). Indicates whether an internal fuse has tripped, either the fuse in the node or at least an electronic fuse in the input module ¹⁾ .

1) An electronic fuse for input modules has been available since February 1999.

General guidelines on I/O addressing

A maximum of 12 electrical modules can be assembled. Note, however, that some modules occupy 2 or even 3 module positions, in which case the maximum number of modules that can be assembled is reduced.

All 12 module positions can generally be used as inputs or outputs, however there are various fieldbus-specific restrictions that are documented in the node description.

The number and type of inputs/outputs, and hence input/output modules, supported by the network also depends on the fieldbus node used. The number of solenoid coils is restricted to 26 and is included in the address space of the digital outputs.

Each sub-base for single solenoid valves occupies 2 outputs, and each sub-base for double solenoid valves occupies 4 outputs. Within the output addresses, the valve solenoids are counted in ascending order from left to right starting from the node. In the case of double solenoid valves, coil 14 comes before coil 12 in the counting mode.

The address space of the valves is always rounded up to a value divisible by 4.

The solenoid coils are followed by the general outputs in the address space. The individual outputs in the output modules are listed in the address space in ascending order, from top to bottom and the modules are listed from right to left starting from the node (see diagram).

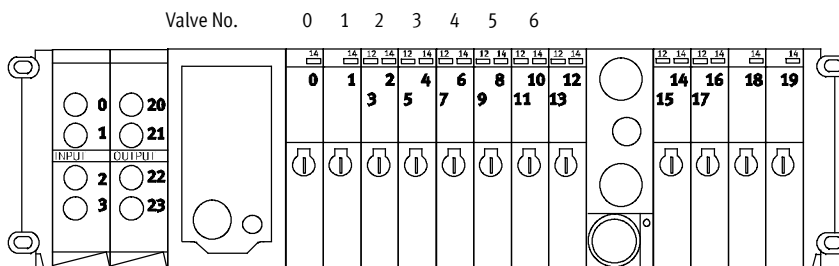

Test method for activation of the solenoid coils

The fieldbus nodes generally contain two different test sequences that activate the solenoid coils independently of any fieldbus combination or higher-order controller so that the function of the assembled valves can be verified.

The solenoid coils will be activated in parallel or serial mode depending on the test sequence selected, with each coil individually activated with a constant switching frequency in a predefined order.

Modular electrical peripherals, for type 03/04

Peripherals overview – Fieldbus systems

Fieldbus systems, programmable terminal groups

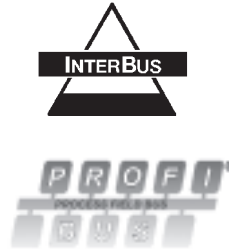
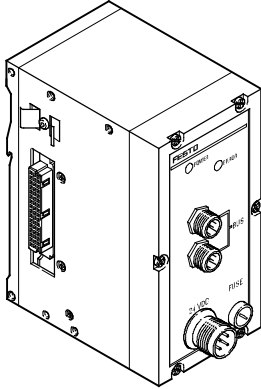

Fieldbus variations:

Of the more than 20 different fieldbus systems (protocols) available in the market, some have emerged as the most important variants. Festo supports these by means of various fieldbus nodes (FBxx) on its valve terminals. Fieldbus systems require a powerful, central PLC and a master interface adapted to that particular fieldbus.

Fieldbus systems are generally used when several devices with many inputs/outputs, complex functions or high communication levels must be controlled. In this case, the advantages of simple cabling, easy diagnosis and maintenance outweigh the extra outlay for a fieldbus master interface and the necessary know-how.

INTERBUS, INTERBUS-FOC:

An open fieldbus standard, originally developed by Phoenix Contact and now in worldwide use. Important installation accessories such as bus plugs must be obtained from Phoenix or its partners (Festo FB6). Festo FB21 is required for INTERBUS-FOC, the Interbus variant "Rugged Line" with fibre optic cable.

PROFIBUS DP:

An open fieldbus standard, originally developed by Siemens and in worldwide use (Festo FB13 for 12 MBd).

- 1 - Type discontinued
Available up until 2017

Modular electrical peripherals, for type 03/04

Peripherals overview – Bus nodes

FESTO

Equipping with bus node

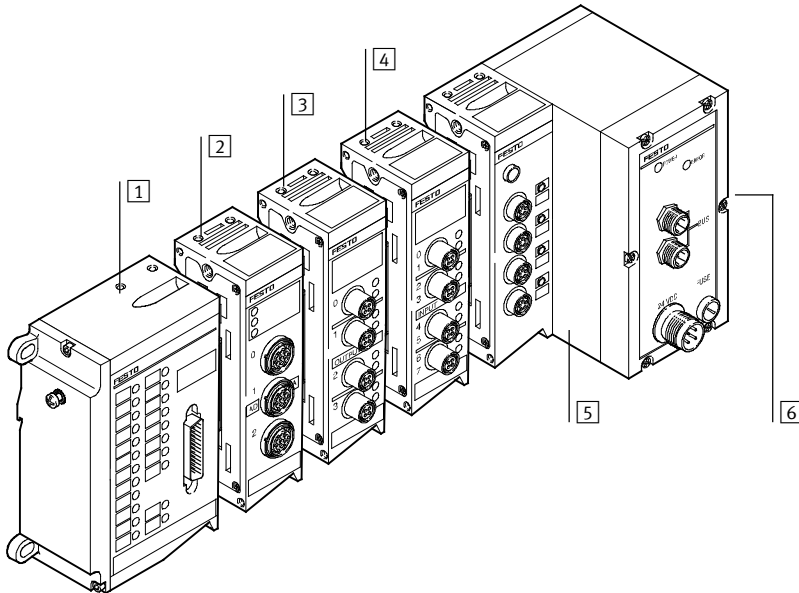

- 1 Input/output module
- 2 Analogue stage
- 3 Output module
- 4 Input module
- 5 Bus node
- 6 Connection side for pneumatics

Modular electrical peripherals for type 03/04 can be equipped with bus node. In addition to controlling the valves and electrical outputs, corresponding sensor feedback can be recorded at the electrical peripherals and transmitted via the fieldbus to the control cabinet.

The following applies to bus nodes:

- Max. 26 valve solenoid coils
- Number of inputs dependent on fieldbus type
- Number of electrical outputs dependent on fieldbus type and number of pneumatic valves
- Status bits for program controlled diagnosis occupy 4 input bits
 - Undervoltage of valves
 - Undervoltage of sensors
 - Short circuit at outputs
- I/O allocation, self-configuration
- Subsequent addition of input or output modules moves the addressing (I/O allocation) forwards
- I/O allocation of inputs and outputs independent from each other
- 4-fold and 8-fold input modules connect to the next Half-Byte (nibble)
- Electrical outputs connect to the next Half-Byte (nibble) on the valves.
Counting mode:
Valves from left to right, then from the next Nibble electrical outputs from right to left
- Max. 12 modules are permitted on the left (electrical) side

Modular electrical peripherals, for type 03/04

FESTO

Peripherals overview – Bus nodes

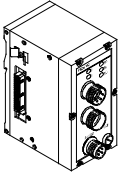
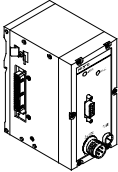
Fieldbus node						
View	Code	Type	Fieldbus protocol	Suitable for		→ Page/Internet
				I/O	Analogue	
	FB6	IFB6-03	INTERBUS	■ 60/64	■	11
	F13	IFB13-03	PROFIBUS DP, 12 MBd	■ 92/74	■	15

Overview – Address space for bus nodes							
	Bus protocol	Max. total		Max. digital		Max. analogue	
		Inputs	Outputs	Inputs	Outputs	Inputs	Outputs
IFB6-03	INTERBUS	60 bit	64 bit	60 DI	60 DO	8 AI	8 AO
IFB13-03	PROFIBUS DP	92 bit	74 bit	92 DI	74 DO	12 AI/AO	–

- DI = Digital inputs (1 bit)
- DO = Digital outputs (1 bit)
- AI = Analogue inputs (16 bit)
- AO = Analogue outputs (16 bit)

 Type discontinued
Available up until 2017

Modular electrical peripherals, for type 03/04

FESTO

Peripherals overview

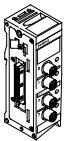
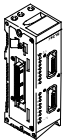
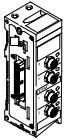
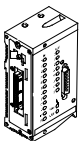
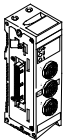
Electronics modules with bus node combinations				
Electronics modules	Type	Bus node		→ Page/Internet
		IFB6-03	IFB13-03	
Input modules				
	VIGE-03-FB-8-5POL Input module for standard inputs PNP, 8-fold, 5-pin	■	■	19
	VIGE-03-FB-8,1-5POL Input module for high-speed inputs (1 ms) PNP, 8-fold, 5-pin	■	■	19
	VIGE-03-FB-8-5POL-S Input module for standard inputs PNP, 8-fold, 5-pin, with separate fuse	■	■	19
	VIGE-03-FB-4-5POL Input module for standard inputs PNP, 4-fold, 5-pin	■	■	19
	VIGE-03-FB-16-SUBD-S Input module with Sub-D plug PNP, 16-fold, 2x 15-pin socket	■	■	23
Output modules				
	VIGA-03-FB-4-5POL Output module for standard outputs PNP, 4-fold, 5-pin	■	■	26
Input/output modules				
	VIEA-03-FB-12E-8A-SUBD Input/output module PNP, 12I/8O, Sub-D	■	■	28
Analogue stage				
	VIAU-03-FB-U Analogue stage 3I/1O, 0 ... 10 V DC	■	■	30
	VIAU-03-FB-I Analogue stage 3I/1O, 4 ... 20 mA	■	■	30

Modular electrical peripherals, for type 03/04

Technical data – Bus node IFB6-03



This bus node handles communication between the modular electrical peripherals and a higher-order master.

For the modular electrical peripherals, this module provides the separate electrical system supply for

- the electronics modules and sensor supply, and
- the load current of the electrical outputs and valves.



Application

Bus connection

The bus connection is established via two 9-pin M23 connections with a typical INTERBUS pin allocation.

The plug and socket are labelled with Remote IN and Remote OUT in accordance with the definition for the INTERBUS remote bus.

Both bus cables are always routed to the bus node and looped through in accordance with the ring structure of the INTERBUS.

Implementation

The IFB6-03 supports the digital input and output modules and the solenoid coils. It also supports analogue modules. It can service a total of 64 digital outputs, of which max. 26 can include

solenoid coils, and 60 digital inputs. The FB6 supports max. 8 analogue input channels and 8 analogue output channels. The analogue channels are operated

in multiplex mode and occupy 16 process data bits. The number of possible digital inputs and outputs is reduced by 16 bits when analogue modules are used.



Note

Please observe the general guidelines on I/O addressing when assigning the outputs.

- 1 - Type discontinued
Available up until 2017

Modular electrical peripherals, for type 03/04

FESTO

Technical data – Bus node IFB6-03

General technical data			
Type		IFB6-03	
Combination with analogue modules		Yes	
Baud rates	[kbps]	500	
ID code		1, 2 or 3 depending on expansion	
No. of process data bits		16, 32, 48 or 64 depending on expansion	
PCP channel		No	
Configuration support		<ul style="list-style-type: none"> • Icon file for CMD software • Station description file with CMD software 	
Max. no. of solenoid coils		26	
Max. no. of outputs incl. solenoid coils		64	
Max. no. of inputs		60	
LED diagnostic displays	UL	Operating voltage of internal electronics	
	UI	Operating voltage of INTERBUS interface	
	RC	Remotebus check	
	BA	Bus active	
	RD	Remotebus disable	
Device-specific diagnostics transmitted to the controller		<ul style="list-style-type: none"> • Short circuit/overload, outputs • Undervoltage of valves • Undervoltage of outputs • Undervoltage of sensor supply • Error during analogue processing 	
Operating voltage	Nominal value	[V DC]	24 polarity-safe
	Permissible range	[V DC]	18 ... 30
	Power failure buffering	[ms]	20
Current consumption		[mA]	200 + total current consumption of inputs, internal
Protection class to EN 60529		IP65	
Temperature range	Operation	[°C]	-5 ... +50
	Storage	[°C]	-20 ... +70
Materials	Housing	Die-cast aluminium	
	Cover	Polyamide	
Dimensions (HxWxD)		[mm]	132 x 85 x 125
Grid dimension		[mm]	72
Weight		[g]	1000

Modular electrical peripherals, for type 03/04

Technical data – Bus node IFB6-03

Connection and display components

The following connection and display components can be found on the bus node cover:

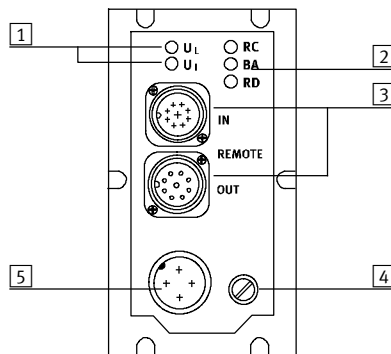

- 1 Power supply indicator
- 2 Fieldbus status indicator
- 3 INTERBUS interface
- 4 Fuse for operating voltage of inputs
- 5 Operating voltage connection

Pin allocation for the INTERBUS interface, non-floating installation remote bus

Terminal allocation	Pin ¹⁾	Signal	Designation
Incoming			
Plug view 	1	DO	Data out
	2	/DO	Data out inverse
	3	DI	Data in
	4	/DI	Data in inverse
	5	Ground	Reference conductor
	6	FE	Functional earthing
	7	+24 V DC	Installation remote bus supply
	8	+0 V	Installation remote bus supply
	Sleeve	Screen	Screening
Outgoing			
Socket view 	1	DO	Data out
	2	/DO	Data out inverse
	3	DI	Data in
	4	/DI	Data in inverse
	5	Ground	Reference conductor
	6	FE	Functional earthing Installation remote bus
	7	+24 V DC	Installation remote bus supply
	8	+0 V	Installation remote bus supply
	9	RBST	Establish bridge to pin 5
Sleeve	Screen	Screening	









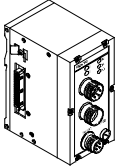

1) Pins not listed here must not be connected.

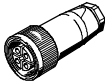
 Type discontinued
Available up until 2017

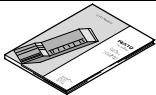
Modular electrical peripherals, for type 03/04

FESTO

Accessories – Bus node IFB6-03

Ordering data				
Designation			Part No.	Type
Bus node				
	INTERBUS		18736	IFB6-03 
Power supply				
	Plug socket, straight, M18x1, 4-pin	for 1.5 mm ²	18493	NTSD-GD-9
		for 2.5 mm ²	18526	NTSD-GD-13,5
	Plug socket, angled, M18x1, 4-pin	for 1.5 mm ²	18527	NTSD-WD-9
		for 2.5 mm ²	533119	NTSD-WD-11
User documentation				
	User documentation – Bus node IFB6-03	German	152756	P.BE-VIFB6-03-DE 
		English	152766	P.BE-VIFB6-03-EN 
		French	163926	P.BE-VIFB6-03-FR 
		Spanish	163906	P.BE-VIFB6-03-ES 
		Italian	165426	P.BE-VIFB6-03-IT 
		Swedish	165456	P.BE-VIFB6-03-SV 

Modular electrical peripherals, for type 03/04

Technical data – Bus node IFB13-03



Bus node for handling communication between the modular electrical peripherals and a higher-order master via PROFIBUS DP.

For the modular electrical peripherals, this module provides the separate electrical system supply for

- the electronics modules and sensor supply, and
- the load current of the electrical outputs and valves.

The status of the voltage supplies and the bus communication is indicated via the LEDs Power, Power Valves and Bus Error.



Application

Bus connection

The bus connection is established via a 9-pin Sub-D socket with a typical PROFIBUS allocation (to EN 50 170).

The bus connector plug (with protection class IP65 from Festo or IP20 from other manufacturers) facilitates the connection of an incoming and an outgoing bus cable.

An active bus terminal can be connected using the integrated DIL switch. The Sub-D interface is designed for the control of network components with a fibre optic cable connection.



- Note

A “Reverse Key” connection can be established via a 2x M12 adapter plug (B-coded).

Implementation

The IFB13-03 supports digital input and output modules and solenoid coils. Analogue modules can also be used.

- 74 digital outputs in total, of which

max. 26 solenoid coils.

- Max. 92 digital inputs for recording sensor signals.

The bus node supports max. 12 ana-

logue input/output channels. Analogue modules occupy a discrete address space, separate from the digital inputs and outputs.



- Note

Please observe the general guidelines on I/O addressing when assigning the outputs.

- 1 - Type discontinued
Available up until 2017

Modular electrical peripherals, for type 03/04

FESTO

Technical data – Bus node IFB13-03

General technical data			IFB13-03
Type			
Combination with analogue modules			Yes
Baud rates			Automatic detection 9.6 kBaud ... 12 MBaud
Addressing range			Set using 2 rotary switches and a DIL switch 1 ... 125
Product family			4: Valves
Ident. number			0xFB13
Type of communication			Cyclic communication
Configuration support			GSD file and bitmaps
Max. no. of solenoid coils			26
Max. no. of outputs and solenoid coils			74
Max. no. of inputs			92
Max. no. of analogue channels			12 input/output channels
LED diagnostic displays	Power		Operating voltage of electronics
	Power V		Operating voltage of valves and outputs
	Bus Error		Communication error
Device-specific diagnostics via PROFIBUS DP			<ul style="list-style-type: none"> • Short circuit/overload, outputs (channel diagnostics) • Undervoltage of valves • Undervoltage of outputs • Undervoltage of sensor supply • Error during analogue processing
Additional functions			<ul style="list-style-type: none"> • Status/diagnostic bits in the process image of the inputs • Test routine for checking the valves and outputs without bus communication • Indication of the valve terminal configuration via Power V and Bus Error LEDs
Operating voltage	Nominal value	[V DC]	24 polarity-safe
	Permissible range	[V DC]	18 ... 30
	Power failure buffering	[ms]	20
Current consumption		[mA]	200 + total current consumption of inputs, internal
Protection class to EN 60529			IP65
Temperature range	Operation	[°C]	-5 ... +50
	Storage/transport	[°C]	-20 ... +70
Materials	Housing		Die-cast aluminium
	Cover		Polyamide
Dimensions (HxWxD)		[mm]	132 x 85 x 125
Grid dimension		[mm]	72
Weight		[g]	1000

Modular electrical peripherals, for type 03/04

Technical data – Bus node IFB13-03

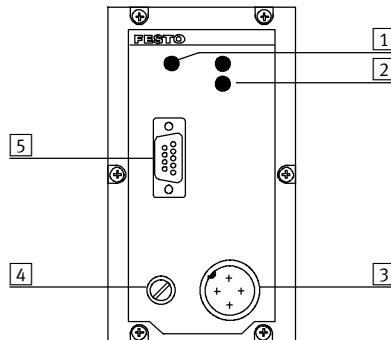

Connection and display components

The following connection and display components can be found on the bus node cover:

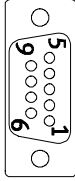

- 1 Green LED / Power
- 2 Red LED / Bus
- 3 Operating voltage connection
- 4 Fuse for operating voltage of inputs
- 5 Plug for fieldbus cable

Pin allocation for PROFIBUS DP interface

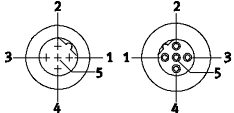
	Terminal allocation		Pin	Signal	Designation
Plug, Sub-D					
	Viewed from the socket side 	Socket	1	n.c.	Not connected
			2	n.c.	Not connected
			3	RxD/TxD-P	Received/transmitted data P
			4	CNTR-P ¹⁾	Repeater control signal
			5	DGND	Data reference potential (M5V)
			6	VP	Supply voltage (P5V)
			7	n.c.	Not connected
			8	RxD/TxD-N	Received/transmitted data N
			9	n.c.	Not connected
			Housing	Screen	Connection to housing
Bus connection M12 adapter plug (B-coded)					
	Plug and socket 	Plug	1	n.c.	Not connected
			2	RxD/TxD-N	Received/transmitted data N
			3	n.c.	Not connected
			4	RxD/TxD-P	Received/transmitted data P
			5 and M12	Screen	Connection to FE
		Socket	1	VP	Supply voltage (P5V)
			2	RxD/TxD-N	Received/transmitted data N
			3	DGND	Data reference potential (M5V)
			4	RxD/TxD-P	Received/transmitted data P
			5 and M12	Screen	Connection to FE











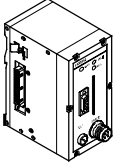

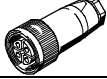
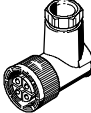
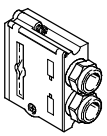
1) The repeater control signal CNTR-P is realised as a TTL signal.

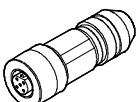
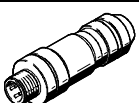
 Type discontinued
Available up until 2017

Modular electrical peripherals, for type 03/04

FESTO

Accessories – Bus node IFB13-03

Ordering data			
Designation		Part No.	Type
Bus node			
	PROFIBUS	174335	IFB13-03 
Power supply			
	Plug socket, straight, M18x1, 4 pin	for 1.5 mm ²	18493 NTSD-GD-9
		for 2.5 mm ²	18526 NTSD-GD-13,5
	Plug socket, angled, M18x1, 4 pin	for 1.5 mm ²	18527 NTSD-WD-9
		for 2.5 mm ²	533119 NTSD-WD-11
Fieldbus connection			
	Plug, Sub-D	532216	FBS-SUB-9-GS-DP-B
	Bus connection, 2x M12 adapter plug (B-coded)	533118	FBA-2-M12-5POL-RK
	Socket M12x1, 5-pin, straight	for self-assembly of a connecting cable for FBA-2-M12-5POL-RK	1067905 NECU-M-B12G5-C2-PB
	Plug M12x1, 5-pin, straight	for self-assembly of a connecting cable for FBA-2-M12-5POL-RK	1066354 NECU-M-S-B12G5-C2-PB
User documentation			
	User documentation – Bus node IFB13-03	German	163953 P.BE-VIFB13-03-DE 
		English	163958 P.BE-VIFB13-03-EN 
		French	163933 P.BE-VIFB13-03-FR 
		Spanish	163913 P.BE-VIFB13-03-ES 
		Italian	165433 P.BE-VIFB13-03-IT 
		Swedish	165463 P.BE-VIFB13-03-SV 

Modular electrical peripherals, for type 03/04

Technical data – Input module, digital, 4-/8-fold

Function

Digital input modules facilitate the connection of proximity sensors or other 24 V DC sensors (inductive, capacitive, etc.).

Plugs with double allocation are separated using a DUO plug or DUO cable. These modules cannot be operated on the multi-pin node with inputs.

Applications

- Input modules for 24 V DC sensor signals
- M12 plug, single allocation connection technology in 4-fold modules, double allocation connection technology in 8-fold modules
- M12 plug, 5-pin
- The input statuses are indicated for each input signal at an allocated LED
- 24 V DC supply provided for all connected sensors
- Module width: 36 mm



General technical data				
Type		VIGE-03-FB-8-5POL	VIGE-03-FB-4-5POL	VIGE-03-FB-8,1-5POL
Input type		Standard inputs, PNP	Input plug with single allocation, PNP	High-speed inputs, PNP
No. of inputs		8	4	8
No. of occupied module positions		1		
Sensor connection type		4xM12, 5-pin, socket with double allocation	4xM12, 5-pin, socket with single allocation	4xM12, 5-pin, socket with double allocation
Max. power supply per channel	[A]	2		
Max. sensor supply per module	[A]	2		
Fuse protection for sensor supply		Central fuse 2 A, in system supply		
Current consumption of module	[mA]	Typical 12		
Supply voltage of sensors	[V DC]	24 ±25%, coming from bus node		
Switching level	Signal 0	[V DC]	≤5 DC	
	Signal 1	[V DC]	≥10 DC	
Input delay	[ms]	3		
Switching logic		PNP (for input signals with positive logic)		
Input characteristic curve		To IEC 1131-2		
Protection class to EN 60529		IP65 (when fully plugged-in or fitted with protective cover)		
Temperature range	Operation	[°C]	-5 ... +50	
	Storage	[°C]	-20 ... +70	
Material		Die-cast aluminium		
Dimensions	[mm]	132 x 36 x 70		
Grid dimension	[mm]	36		
Weight	[g]	360		

 Type discontinued
Available up until 2017

Modular electrical peripherals, for type 03/04

FESTO

Technical data – Input module, digital, 4-/8-fold

General technical data		
Type	VIGE-03-FB-8-5POL-S	
Input type	With separate fuse, PNP	
No. of inputs	8	
No. of occupied module positions	1	
Sensor connection type	4xM12, 5-pin, socket with double allocation	
Max. power supply per channel	[A]	2
Max. sensor supply per module	[A]	0.5
Fuse protection for sensor supply	Internal electrical fuse	
Current consumption of module	[mA]	Typical 12
Supply voltage of sensors	[V DC]	24 ±25%, coming from bus node
Switching level	Signal 0	[V DC] ≤6
	Signal 1	[V DC] ≤8.6
Input delay	[ms]	3
Switching logic	PNP (for input signals with positive logic)	
Input characteristic curve	To IEC 1131-2	
Protection class to EN 60529	IP65 (when fully plugged-in or fitted with protective cover)	
Temperature range	Operation	[°C] -5 ... +50
	Storage	[°C] -20 ... +70
Material	Die-cast aluminium	
Dimensions	[mm]	132 x 36 x 70
Grid dimension	[mm]	36
Weight	[g]	360

Modular electrical peripherals, for type 03/04

Technical data – Input module, digital, 4-/8-fold

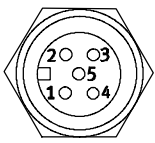
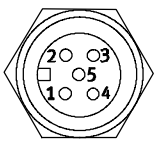
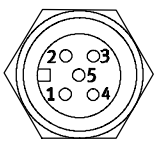
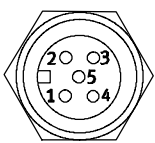
Pin allocation						
Terminal allocation	4-fold			8-fold		
	Pin	Signal	LED	Pin	Signal	LED
5-pin input modules						
	1	+24 V	0	1	+24 V	0
	2	n.c.		2	Ix+1	
	3	0 V		3	0 V	
	4	Ix		4	Ix	
	5	Earth terminal		5	Earth terminal	
	1	+24 V	1	1	+24 V	2
	2	n.c.		2	Ix+3	
	3	0 V		3	0 V	
	4	Ix+1		4	Ix+2	
	5	Earth terminal		5	Earth terminal	
	1	+24 V	2	1	+24 V	4
	2	n.c.		2	Ix+5	
	3	0 V		3	0 V	
	4	Ix+2		4	Ix+4	
	5	Earth terminal		5	Earth terminal	
	1	+24 V	3	1	+24 V	6
	2	n.c.		2	Ix+7	
	3	0 V		3	0 V	
	4	Ix+3		4	Ix+6	
	5	Earth terminal		5	Earth terminal	



Ix Input x

- 1 - Type discontinued
Available up until 2017

Modular electrical peripherals, for type 03/04

Accessories – Input module, digital, 4-/8-fold

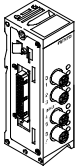
FESTO

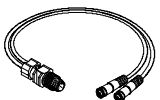
Ordering data				
Designation			Part No.	Type
Input module, digital				
	8 digital inputs, positive logic (PNP), standard inputs		175555	VIGE-03-FB-8-5POL
	4 digital inputs, positive logic (PNP), input plug with single allocation		175557	VIGE-03-FB-4-5POL
	8 digital inputs, positive logic (PNP), high-speed inputs		175559	VIGE-03-FB-8,1-5POL
	8 digital inputs, positive logic (PNP), with separate fuse		188521	VIGE-03-FB-8-5POL-S
Sensor plug				
	Plug, straight socket, M12	5-pin, PG7	175487	SEA-M12-5GS-PG7
		4-pin, PG7	18666	SEA-GS-7
		4-pin, 2.5 mm ² OD	192008	SEA-4GS-7-2,5
	Plug for 2 sensor cables, M12, PG11	4-pin	18779	SEA-GS-11-DUO
		5-pin	192010	SEA-5GS-11-DUO
DUO cable				
	DUO cable	2x straight socket	18685	KM12-DUO-M8-GDGD
		2x straight/angled socket	18688	KM12-DUO-M8-GDWD
		2x angled socket	18687	KM12-DUO-M8-WDWD

Modular electrical peripherals, for type 03/04

Technical data – Input module, digital, 16-fold

Function

Sensor signals in groups of up to 8 or 12 are recorded by multi-pin distributors and forwarded to the module via a multi-pin cable.

Applications

- Input modules for 24 V DC sensor signals
- 2 connector plugs, Sub-D 15-pin socket
- Ready for installation for multi-pin distributors with up to 8 or 12 inputs
- Allocation of the plug variables
 - 8 inputs on top and 8 inputs on bottom
 - 12 inputs on top and 4 inputs on bottom
- The input statuses are indicated for each input signal at an assigned LED
- 24 V DC voltage supplied separately for both plugs, with separate electronic fuse
- Module width: 36 mm



General technical data			
Type		VIGE-03-FB-16-SUBD-S	
No. of inputs		16	
No. of occupied module positions		2	
Sensor connection type		2x Sub-D, 15-pin socket	
Max. sensor supply per connection		[A]	0.5
Max. sensor supply per module		[A]	1
Fuse protection for sensor supply		Separate electronic fuse for each connection	
Current consumption of module		[mA]	12
Supply voltage of sensors		[V DC]	24 ±25%, coming from bus node
Switching level	Signal 0	[V DC]	≤6
	Signal 1	[V DC]	≥8.6
Input delay		[ms]	3
Switching logic		PNP (for input signals with positive logic)	
Input characteristic curve		To IEC 1131-2	
Protection class to EN 60529		IP65 (when fully plugged-in or fitted with protective cover)	
Temperature range	Operation	[°C]	-5 ... +50
	Storage	[°C]	-20 ... +70
Material		Die-cast aluminium	
Dimensions (HxWxD)		[mm]	132 x 36 x 56
Grid dimension		[mm]	36
Weight		[g]	360

- 1 - Type discontinued
Available up until 2017

FESTO

Modular electrical peripherals, for type 03/04

Technical data – Input module, digital, 16-fold

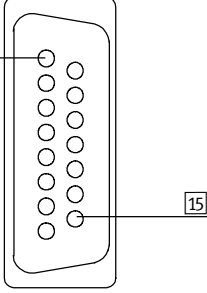
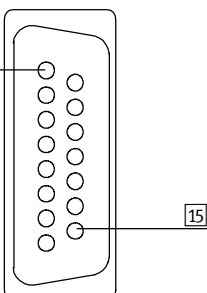
Pin allocation		
Terminal allocation	Pin	Signal
	1	Ix
	2	Ix+1
	3	Ix+2
	4	Ix+3
	5	Ix+4
	6	Ix+5
	7	Ix+6
	8	Ix+7
	9	Ix+8 ¹⁾
	10	Ix+9 ¹⁾
	11	Ix+10 ¹⁾
	12	Ix+11 ¹⁾
	13	24 V DC sensor supply
	14	0 V
	15	PE housing
	1	Ix+8 ¹⁾
	2	Ix+9 ¹⁾
	3	Ix+10 ¹⁾
	4	Ix+11 ¹⁾
	5	Ix+12
	6	Ix+13
	7	Ix+14
	8	Ix+15
	9	Free
	10	Free
	11	Free
	12	Free
	13	24 V DC sensor supply
	14	0 V
	15	PE housing

Ix Input x

1) Two sets of inputs signals, connect to either of the two plugs.

- 1 - Type discontinued
Available up until 2017

FESTO

Modular electrical peripherals, for type 03/04

Accessories – Input module, digital, 16-fold

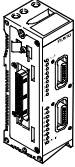
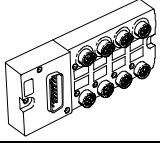
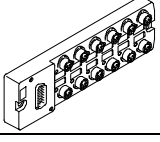
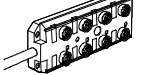
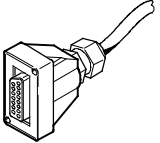
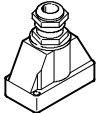
Ordering data			
Designation		Part No.	Type
Input module, digital			
	16 digital inputs, positive logic (PNP), 2x Sub-D, 15-pin socket	192549	VIGE-03-FB-16-SUBD-S
Multi-pin distributors Technical data → 34			
	15-pin plug Sub-D / 8x 3-pin M8 sockets	8 I/Os	177669 MPV-E/A08-M8
	15-pin plug Sub-D / 12x 3-pin M8 sockets	12 I/Os	177670 MPV-E/A12-M8
	15-pin connecting cable / 8x 5-pin M12 sockets	8 I/Os	177671 MPV-E/A08-M12
Cables and plugs			
	Plug socket with cable, open at one end	5 m	177673 KMPV-SUB-D-15-5
		10 m	177674 KMPV-SUB-D-15-10
	Plug socket Sub-D, plug	192768	SD-SUB-D-ST15

- 1 - Type discontinued
Available up until 2017

FESTO

Modular electri peripherals, for type 03/04

Technical data – Output module, digital

Function

The electrical outputs control actuators such as individual valves, hydraulic valves, heating controllers and many more.

- 1 - Note

Valves with M12 central plug, optimum control.

Applications

- Output module with 4 outputs 24 V DC
- M12 connection technology, with 5-pin sockets
- LED display of the switching status per channel
- Short circuit and overload detection per output
 - Separate malfunction display for each channel by means of red LED
 - Diagnostic message about system status to controller





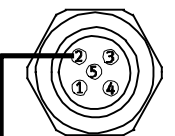
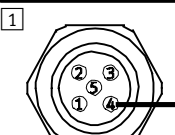
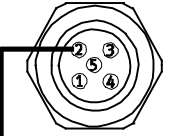
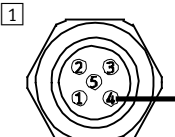

General technical data		VIGA-03-FB-4-5POL
Type		VIGA-03-FB-4-5POL
Output type		Standard outputs, PNP
No. of outputs		4
No. of occupied module positions		1
Output connection type		4xM12, 5-pin, socket with double allocation
Max. output current	per channel	[A] 0.5
	per module	[A] 2.0
Operating voltage	[V DC]	24 ±25%
Load voltage connection	[V DC]	24 ±10%
Parallel connection possible		Yes, within the module only
Fuse protection for output line		Electronic fuse per channel 0.5 A
Current consumption of module	[mA]	9
Overload/short circuit protection		Per channel
Switching logic		To IEC 1131-2
Protection class to EN 60529		IP65 (when fully plugged-in or fitted with protective cover)
Temperature range	Operation	[°C] -5 ... +50
	Storage	[°C] -20 ... +70
Material		Die-cast aluminium
Dimensions (HxWxD)	[mm]	132 x 36 x 69
Grid dimension	[mm]	36
Weight	[g]	360

Modular electrical peripherals, for type 03/04

Accessories – Output module, digital

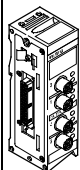
Pin allocation – Standard			
Terminal allocation	LED	Pin	Signal
	0	1	n.c.
		2	Ox+1
		3	0 V
		4	Ox
		5	Earth terminal
	1	1	n.c.
		2	n.c.
		3	0 V
		4	Ox+1
		5	Earth terminal
	2	1	n.c.
		2	Ox+3
		3	0 V
		4	Ox+2
		5	Earth terminal
	3	1	n.c.
		2	n.c.
		3	0 V
		4	Ox+3
		5	Earth terminal

1 Internal connection in module
Ox Output x

Ordering data			
Designation	Part No.	Type	
Output module, digital			
	4 digital outputs, positive logic (PNP), standard outputs	175641	VIGA-03-FB-4-5POL
Sensor plug			
	Plug, straight socket, M12	5-pin, Pg7	175487 SEA-M12-5GS-PG7
	Plug for 2 sensor cables, M12, PG11	5-pin	192010 SEA-5GS-11-DUO
DUO cable			
	DUO cable	2x straight socket	18685 KM12-DUO-M8-GDGD
		2x straight/angled socket	18688 KM12-DUO-M8-GDWD
		2x angled socket	18687 KM12-DUO-M8-WDWD

- 1 - Type discontinued
Available up until 2017

Modular electrical peripherals, for type 03/04

Technical data – Input/output module

FESTO

Function

Digital input modules facilitate the connection of proximity sensors or other 24 V DC sensors (inductive, capacitive, etc.).

The electrical outputs control actuators such as individual valves, lamps and a host of other devices. The I/O module occupies 3 module positions.

Its electrical isolation makes it suitable as a coupling connection to external circuits.

Applications

The I/O module combines 12 inputs and 8 outputs in one module with a width of 72 mm. The connection is established via a pre-assembled 25-pin Sub-D plug with multi-pin cable. 24 V DC internal supply to the sensor connections. The switching status displays for the inputs/outputs are shown on assigned LEDs.

4 outputs are combined into a group and supplied externally with 24 V DC. The inputs and outputs are electrically isolated from the node.



General technical data			
Type		VIEA-03-FB-12E-8A-SUBD	
Number	Inputs	12	
	Outputs	8	
No. of occupied module positions		3	
Sensor connection and output type		25-pin multi-pin cable and Sub-D plug connector	
Max. power supply per channel	[A]	2	
Max. sensor supply per module	[A]	2	
Fuse protection for sensor supply		Central fuse 2 A, in system supply	
Current consumption of module		Typically 8 mA (inputs) 5 mA (outputs) per group of four	
Capacity per digital output	[A]	0.5 internal electronic fuse	
Supply voltage of sensors		[V DC]	24 ±25%, coming from bus node
Switching level	Signal 0	[V DC]	≤ 5
	Signal 1	[V DC]	≥ 11
Input delay	[ms]	5	
Switching logic		PNP (for input signals with positive logic)	
Input characteristic curve		To IEC 1131-2	
Protection class to EN 60529		IP65 (when fully plugged-in or fitted with protective cover)	
Temperature range	Operation	[°C]	-5 ... +50
	Storage	[°C]	-20 ... +70
Material		Die-cast aluminium	
Dimensions (HxWxD)		[mm]	132 x 78 x 78
Grid dimension		[mm]	72
Weight		[g]	700

Modular electrical peripherals, for type 03/04

Accessories – Input/output module

Pin allocation				
	Pin	Signal	Core colour of data cable KEA-1-25P-...	
	1	Ix	white	
	2	Ix+1	green	
	3	Ix+2	yellow	
	4	Ix+3	grey	
	5	Ix+4	pink	
	6	Ix+5	blue	
	7	Ix+6	red	
	8	Ix+7	magenta	
	9	Ix+8	grey-pink	
	10	Ix+9	red-blue	
	11	Ix+10	white-green	
	12	Ix+11	brown-green	
	13	0 V of inputs	white-yellow	
	14	Ox	yellow-brown	
	15	Ox+1	white-grey	
	16	Ox+2	grey-brown	
	17	Ox+3	white-pink	
	18	Ox+4	pink-brown	
	19	Ox+5	white-blue	
	20	Ox+6	brown-blue	
	21	Ox+7	white-red	
	22	24 V DC (for the outputs Ox ... Ox+3)		brown-red
	23	24 V DC (for the outputs Ox+4 ... Ox+7)		white-black
	24	0 V (for the outputs Ox ... Ox+3)		brown
	25	0 V (for the outputs Ox+4 ... Ox+7)		black

Ix Input x
Ox Output x

Ordering data			
Designation	Part No.	Type	
Input/output module, digital			
	12 digital inputs, 8 digital outputs	174483	VIEA-03-FB-12E-8A-SUBD
Cables and plugs			
	Connecting cable	5 m	177413 KEA-1-25P-5
		10 m	177414 KEA-1-25P-10
		x length	177415 KEA-1-25P-X
	Plug socket Sub-D, socket	18709	SD-SUB-D-BU25

Modular electrical peripherals, for type 03/04

Technical data – Analogue stage

FESTO

Function

Analogue signals, as well as digital inputs and outputs, are required in many areas of automation. Special analogue stages are provided for these tasks which are capable of processing both analogue input signals, e.g. setpoint specifications and feedback on actual values (temperature, pressure, flow rate, fill-level, etc.), as well as analogue outputs for controlling actuators. The analogue stages are specially prepared for the connection of proportional valves¹⁾.

Applications

- 6-pin push-in connectors to DIN 45 332
 - Diagnostic LED to indicate readiness for service and overload
 - Voltage supplied for all connected sensors
- Two analogue stages are available for different fields of application:
- VIAU-03-FB-I, universal module for current signals
 - 3 analogue inputs (4 ... 20 mA)
 - 1 analogue output (4 ... 20 mA)
 - VIAU-03-FB-U, universal module for voltage signals
 - 3 analogue inputs (0 ... 10 V)
 - 1 analogue output (0 ... 10 V)



VIAU-03-FB-...

1) Not suited for MPPES

General technical data		VIAU-03-FB-I ¹⁾	VIAU-03-FB-U ¹⁾
Type	Number	3	3
	Inputs	3	3
	Outputs	1	1
Sensor connection type		3x 6-pin socket, DIN 45322	
Max. sensor supply per module [A]		2	0.5
Fuse protection for sensor supply		Central fuse 2 A, in system supply	
Current consumption of module [mA]		64	
Supply voltage of sensors [V DC]		24 ±25%, coming from bus node	
Actuator supply voltage [V DC]		24 ±10%, external	
Actuator supply, average continuous loading capability [A]		Max. 1	
Analogue current inputs	Signal range	4 ... 20 mA	0 ... 10 V DC
	Resolution [bit]	11	12
	No. of units	2 048	4 096
	Absolute precision [%]	0.45	0.4
	Input resistance [kΩ]	0.050	≥ 20
	Max. permissible input current [mA]	65	
	Input voltage [V DC]	–	30
Input signal cut-off frequency [Hz]		116	
Linearity	Differential non-linearity	2 LSB	
	Integral non-linearity	3 LSB	

1) Not suited for MPPES

Modular electrical peripherals, for type 03/04

Technical data – Analogue stage

General technical data			
Type		VIAU-03-FB-1 ¹⁾	VIAU-03-FB-U ¹⁾
Analogue current inputs/outputs	Signal range	4 ... 20 mA	0 ... 10 V DC
	Resolution [bit]	12	
	No. of units	4 096	
	Absolute precision [%]	0.5	0.45
	Load resistance (load) [kΩ]	≤ 0.250	≥ 3.3
Linearity	Differential non-linearity	2 LSB	
	Integral non-linearity	4 LSB	
Protection class to EN 60529		IP65 (when fully plugged-in or fitted with protective cover)	
Temperature range	Operation [°C]	-5 ... +50	
	Storage [°C]	-20 ... +70	
Material		Die-cast aluminium	
Dimensions (HxWxD)	[mm]	132 x 42 x 70	
Grid dimension	[mm]	36	
Weight	[g]	360	

1) Not suited for MPPES

Modular electrical peripherals, for type 03/04

Technical data – Analogue stage

FESTO



Pin allocation		Signal	Signal designation
Analogue stage VIAU-03-FB-I (current signals)			
	n.c.	IIx+	Positive current, input signal
	n.c.	IIx-	Negative current, input signal
	24 V _{Sen}	OI0+	Positive current, output signal
	0 V	OGND	Current output signal
	n.c.	24 V _{Sen}	24 V DC sensor supply voltage
	n.c.	24 V _p	24 V DC actuator supply voltage
	24 V _{Sen}	0 V	0 V actuator/sensor supply voltage
	0 V	Housing	Cable screening connection
	n.c.		
	n.c.		
Analogue stage VIAU-03-FB-U (voltage signals)			
	IU0+	IUx+	Positive voltage, input signal
	IU0-	IUx-	Negative voltage, input signal
	24 V _{Sen}	OU0+	Positive voltage, output signal
	0 V	OGND	Voltage output signal
	n.c.	24 V _{Sen}	24 V DC sensor supply voltage
	n.c.	24 V _p	24 V DC actuator supply voltage
	24 V _{Sen}	0 V	0 V actuator/sensor supply voltage
	0 V	Housing	Cable screening connection
	n.c.		
	n.c.		

- 2 - Type discontinued
Available up until 2017

FESTO

Modular electrical peripherals, for type 03/04

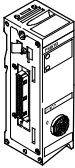
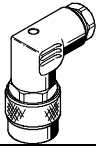
Accessories – Analogue stage

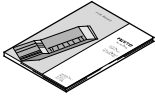
Ordering data			
Designation		Part No.	Type
Input module, analogue			
	3 analogue inputs and 1 analogue output, universal module for current signals	164239	VIAU-03-FB-I
	3 analogue inputs and 1 analogue output, universal module for voltage signals	18692	VIAU-03-FB-U
Connecting cables			
	Connecting cable for Festo proportional pressure regulator, plug/socket pre-assembled at both ends	5 m	163882 KVIA-MPPE-5
		10 m	163883 KVIA-MPPE-10
	Connecting cable for Festo proportional directional control valve, plug/socket pre-assembled at both ends	5 m	161984 KVIA-MPYE-5
		10 m	161985 KVIA-MPYE-10
	Connecting cable for other signal modules, open cable end	5 m	163960 KVIA-5
		10 m	163961 KVIA-10
User documentation			
	User documentation – Analogue stage	German	163946 P.BE-VIAX-03/05-DE
		English	163947 P.BE-VIAX-03/05-EN
		French	163948 P.BE-VIAX-03/05-FR
		Spanish	163949 P.BE-VIAX-03/05-ES
		Italian	165379 P.BE-VIAX-03/05-IT
		Swedish	165539 P.BE-VIAX-03/05-SV

Modular electrical peripherals, for type 03/04

Technical data – Multi-pin distributor

Function

MPV multi-pin distributors are suitable for the distribution of input and output signals to PNP sensors and solenoid valves via the M12/M8 plugs. The multi-pin distributors, in conjunction with the input module VIGE-03-FB-16-SUBD-S (→ 23), collect the sensor signals directly in the machine and forward them to the input module on the 15-pin Sub-D sockets via a multi-pin cable.

- LED for signal status display
- Only one cable to installation location
- A broad range of accessories

Type MPV-E/A...-M8

The multi-pin distributor facilitates the connection of max. 8 or 12 input signals to 3-pin M8x1 plugs. The connecting cable KMPV-SUB-D-15-..., pre-assembled at one end, with the 15-pin Sub-D socket is connected to the multi-pin distributor. The open end of the cable is fitted with the plug socket SD-SUB-D-ST15 and connected to the input module.

Type MPV-E/A08-M12

Connection of max. 8 input signals to 5-pin M12 plug. The connecting cable is permanently attached to the multi-pin distributor. The open end of the cable is fitted with the plug socket SD-SUB-D-ST15 and connected to the input module. Switching status display via yellow LED. Sensor voltage display via green LED.

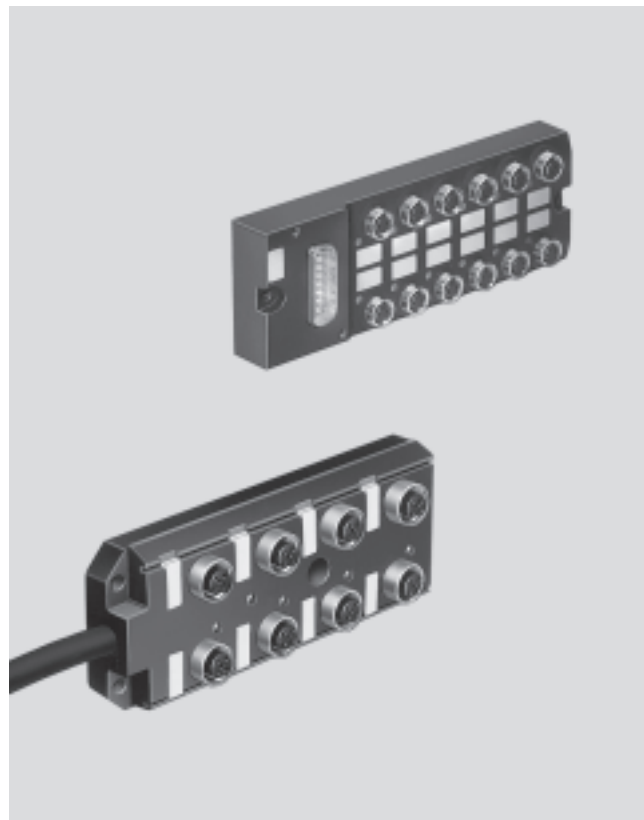

General technical data				
Type		MPV-E/A08-M8	MPV-E/A12-M8	MPV-E/A08-M12
No. of inputs/outputs		8	12	8
Type of mounting		2 through-holes or on H-rail ¹⁾		3 through-holes
Connection		M8x1, 3-pin		M12x1, 5-pin
Permissible voltage	[V DC]	10 ... 30		10 ... 30
Current-carrying capacity	[A]	Max. 1 per module slot Total current: max. 4		Max. 4 per module slot Total current: max. 12
Protection class to EN 60529		IP65 (fully assembled)		IP67 (fully assembled)
Temperature range	Operation	-20 ... +80		-20 ... +80
	Storage	-20 ... +80		-20 ... +80
Materials	Housing	Polyamide		Polyurethane
	Sockets	Brass, gold plated		Galvanised brass
	Cable	-		Polyurethane, polyvinyl chloride
Weight	[g]	100 ²⁾	120 ²⁾	200 ²⁾

1) With adapter CP-TS-HS-35

2) Without cable

Modular electrical peripherals, for type 03/04

Technical data – Multi-pin distributor

Dimensions

Download CAD data → www.festo.com

MPV-E/A...-M8

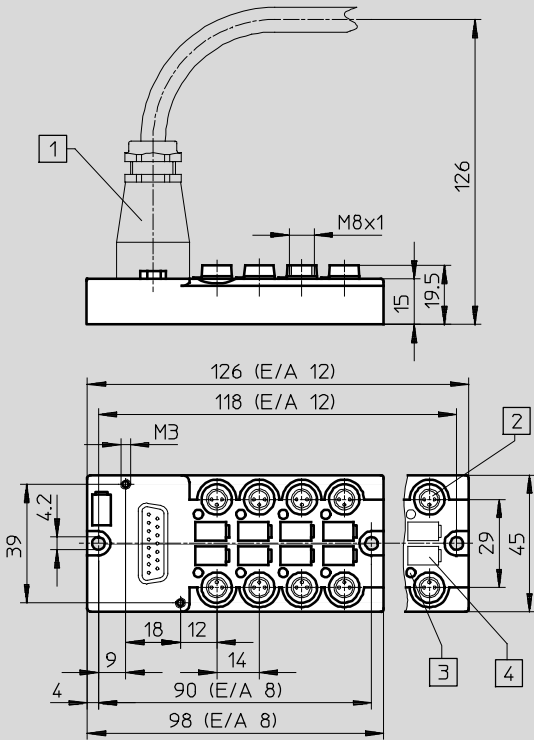

- 1 Multi-pin connection
- 2 3-pin socket, M8x1
- 3 Switching status display, yellow
- 4 Inscription label (type IBS-6x10)

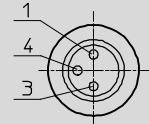

- 1 24 V DC
- 3 0 V
- 4 Signal line (1 ... 8) or (1 ... 12)

MPV-E/A08-M12

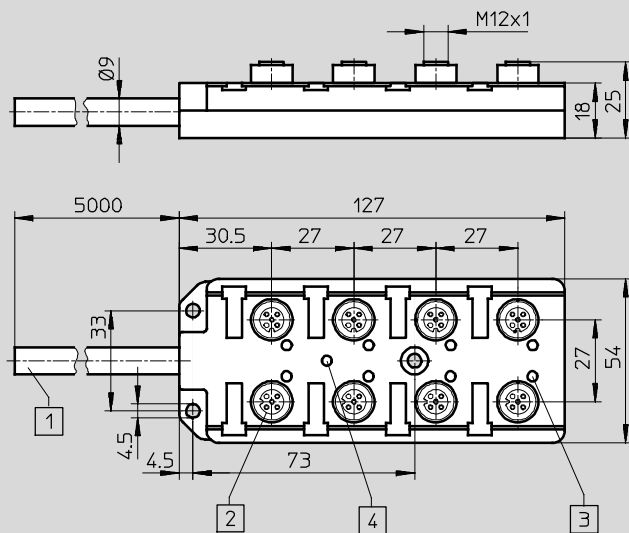

- 1 Connecting cable, 5 m
- 2 5-pin socket, M12 x 1
- 3 Switching status display, yellow
- 4 Voltage display, green

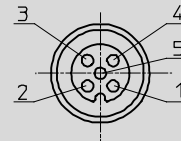



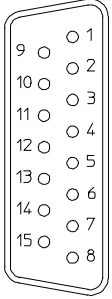

- 1 24 V DC
- 2 n.c.
- 3 0 V
- 4 Signal line (1 ... 8)
- 5 Earth

Modular electrical peripherals, for type 03/04

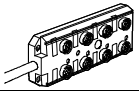
Accessories – Multi-pin distributor

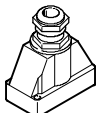



Pin allocation	MPV-E/A...-M8 Cable with 15-pin Sub-D plug			MPV-E/A08-M12 Signal line pins 1 through 12	
	Pin	M8 socket location	Core colour	M12 socket location	Core colour
	1	0/4	white	1/4	white
	2	1/4	brown	2/4	green
	3	2/4	green	3/4	yellow
	4	3/4	yellow	4/4	grey
	5	4/4	grey	5/4	pink
	6	5/4	pink	6/4	red
	7	6/4	blue	7/4	black
	8	7/4	red	8/4	magenta
	9	8/4	black	24 V DC	brown
	10	9/4	magenta	0 V	blue
	11	10/4	grey-pink	PE	green-yellow
	12	11/4	red-blue		
	13	24 V DC	white-green		
	14	0 V	brown-green		
	15	0 V	white-yellow		

Ordering data for MPV-E/A08-M12				
Designation			Part No.	Type
Multi-pin distributors				
	15-pin connecting cable / 8x 5-pin M12 sockets		177671	MPV-E/A08-M12
Plugs and cables				
	Connecting cable for sensors, M12-M12		2.5 m	18684 KM12-M12-GSGD-2,5
			5 m	18686 KM12-M12-GSGD-5
	Plug socket ¹⁾		192768	SD-SUB-D-ST15
Protective cover				
	Cover caps (10 pieces) for unused terminals		165592	ISK-M12

1) A Sub-D plug socket is required to establish a connection between the multi-pin distributor and input module VIGE-03-FB-16-SUBD-S.

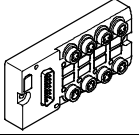
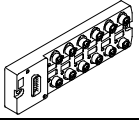
Modular electrical peripherals, for type 03/04

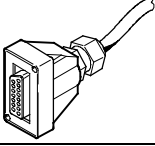
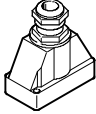
Accessories – Multi-pin distributor

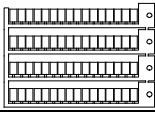
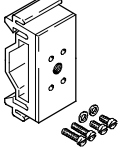
Ordering data for MPV-E/A...-M8			
Designation		Part No.	Type
Multi-pin distributors			
	15-pin plug Sub-D / 8x 3-pin M8 sockets	177669	MPV-E/A08-M8
	15-pin plug Sub-D / 12x 3-pin M8 sockets	177670	MPV-E/A12-M8
Plugs and cables			
	Connecting cable for sensors, M8-M8	2.5 m	165610 KM8-M8-GSGD-2,5
		5 m	165611 KM8-M8-GSGD-5
	Plug socket with cable, open at one end ¹⁾	5 m	177673 KMPV-SUB-D-15-5
		10 m	177674 KMPV-SUB-D-15-10
	Plug socket ¹⁾	192768	SD-SUB-D-ST15
Protective cover			
	Cover caps (10 pieces) for unused terminals	177672	ISK-M8
Designation			
	Inscription labels, pack of 64	18576	IBS-6x10
Mounting			
	Attachment for H-rail mounting, 2 pieces	170169	CP-TS-HS-35

1) A plug socket with cable and a Sub-D plug socket are required to establish a connection between the multi-pin distributor and input module VIGE-03-FB-16-SUBD-S.

-  - Type discontinued
Available up until 2017

Modular electrical peripherals, for type 03/04

Technical data

FESTO

Dimensions – Electrical peripherals with valve terminal type 03
with bus node/control block

Download CAD data → www.festo.com

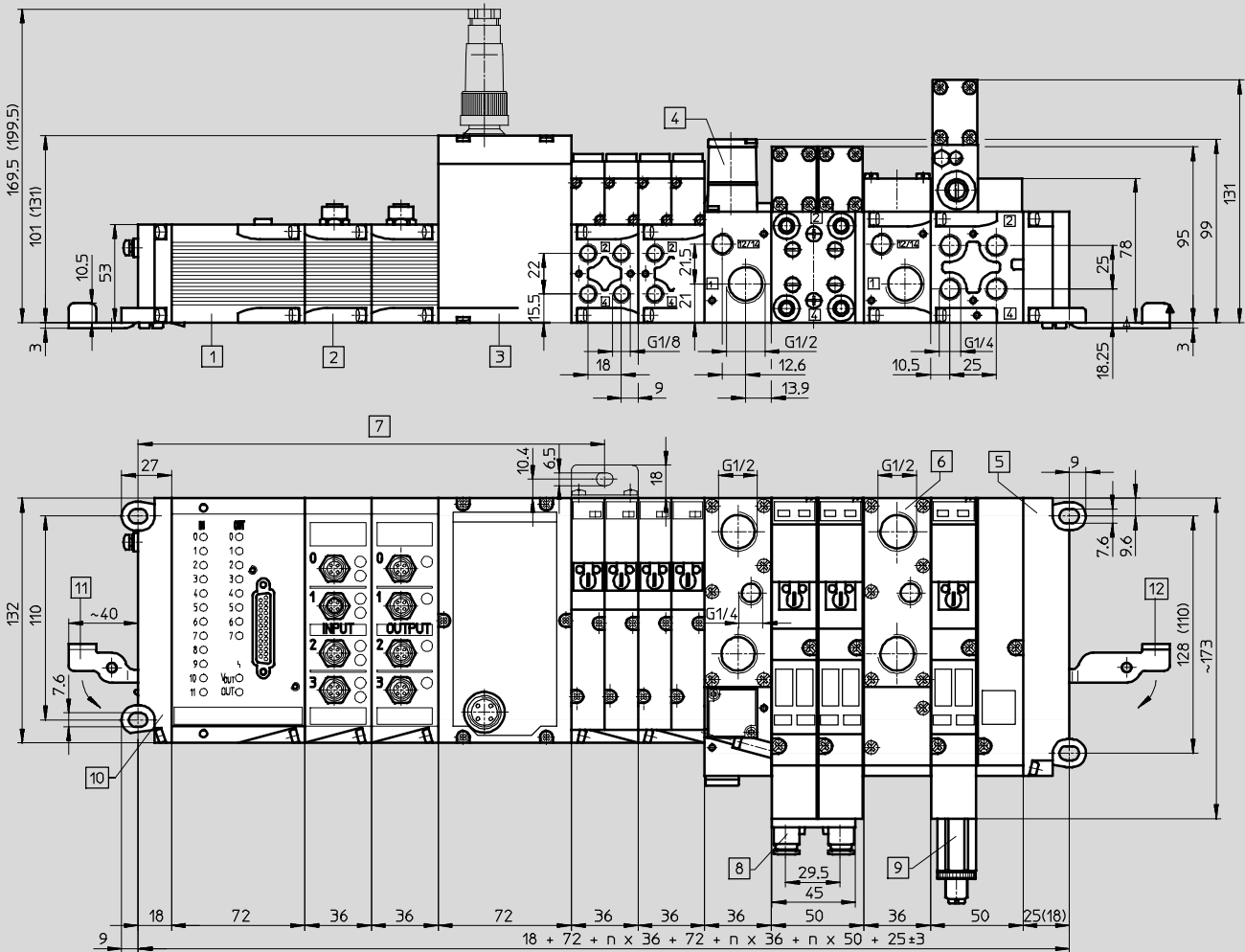

- | | | | |
|---------------------------------|--|---|---|
| 1 Input/output module | 4 Adapter plate MIDI/MAXI with pressure regulating valve for pilot pressure | 7 Mounting bracket for wall mounting required approx. every 200 mm | 11 Swivel lever IBGH-03-4.0 (opened out) for connection to mounting rail |
| 2 Input module | 5 End plate, right-hand (dimensions for MIDI valves in brackets) | 8 One-way flow control valve | 12 Swivel lever IBGH-03-7.0 (opened out) for connection to mounting rail |
| 3 Fieldbus/control block | 6 Compressed-air supply plate | 9 Pressure regulating valve | |
| | | 10 End plate, left-hand | |

-  - Type discontinued
Available up until 2017

Modular electrical peripherals, for type 03/04

Technical data

FESTO

Dimensions – End plates for valve terminal 03

Download CAD data → www.festo.com

MIDI valves

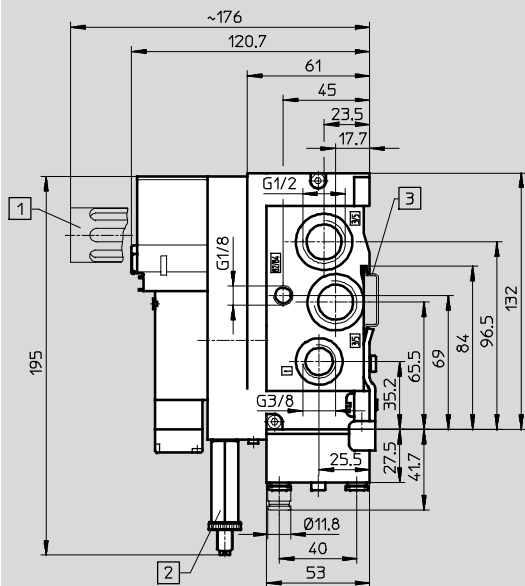

- 1 Silencer
- 2 Pressure regulating valve
- 3 H-rail

MAXI valves

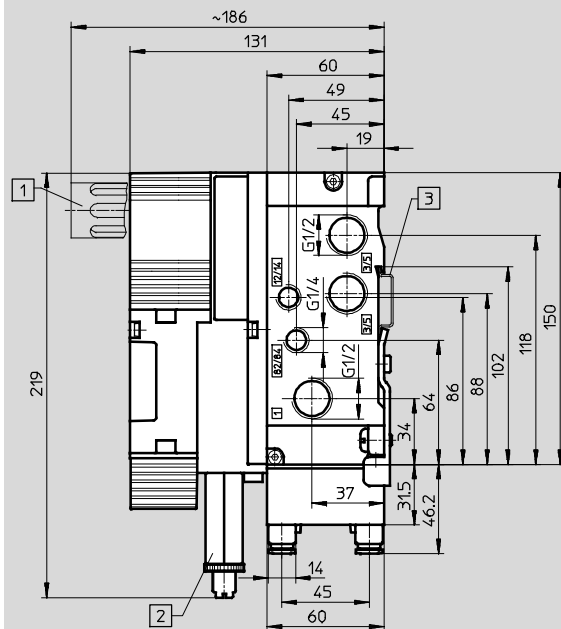

- 1 Silencer
- 2 Pressure regulating valve
- 3 H-rail

-  - Type discontinued
Available up until 2017

Modular electrical peripherals, for type 03/04

Technical data

FESTO

Dimensions – Electrical peripherals with valve terminal type 04
with bus node/control block

Download CAD data → www.festo.com

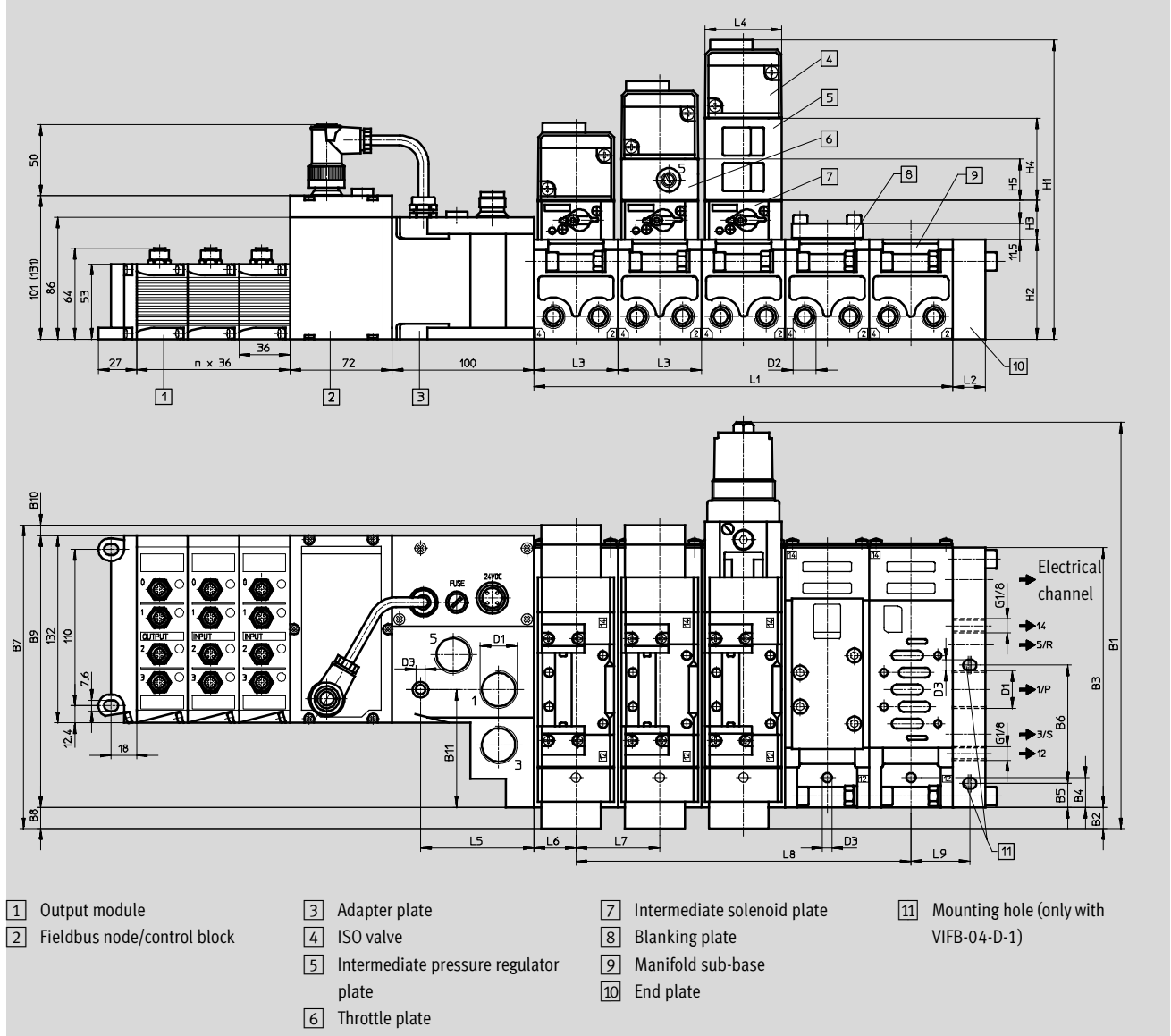

- | | | | |
|-------------------------------|---|-------------------------------|--|
| 1 Output module | 3 Adapter plate | 7 Intermediate solenoid plate | 11 Mounting hole (only with VIFB-04-D-1) |
| 2 Fieldbus node/control block | 4 ISO valve | 8 Blanking plate | |
| | 5 Intermediate pressure regulator plate | 9 Manifold sub-base | |
| | 6 Throttle plate | 10 End plate | |

Type	~B1	B2	B3	B4	B5	B6	B7	B8	B9	B10	B11	D1	D2	D3
VIFB-04-D-1-B	251	33	149	7	17	80	198.5	33	153	12.4	56.9	G1/2	G1/4	6.6
VIFB-04-D-2-B	287	15	183	21	–	–	214	15	191.5	7.5	83	G3/4	G3/8	6.6
VIFB-04-D-3-B	315	6	230	27	–	–	241.5	6	231.6	3.9	79.5	G1	G1/2	9

Type	H1	H2	H3	H4	H5	L1 ¹⁾	L2	L3	L4	L5	L6	L7	L8 ¹⁾	L9
VIFB-04-D-1-B	181.7	64	27	45	25.5	m x 43	22	43	42	80	9.5	43	(m-1) x 43	44.5
VIFB-04-D-2-B	210.8	70	27.8	58	29	m x 59	23	59	54	80	29.5	59	(m-1) x 59	–
VIFB-04-D-3-B	235	82	28	63	40	m x 72	28	72	70	52	36	72	(m-1) x 72	–

1) m = Number of valves

Modular electrical peripherals, for type 03/04

Accessories

Product range overview – Connections for bus nodes and control blocks				
Designation	Type	FB6	FB13	FB21
Fieldbus connection				
Plug, Sub-D	FBS-SUB-9-GS-DP-B	-	■	-
Bus connection, 2x M12 adapter plug (B-coded)	FBA-2-M12-5POL-RK	-	■	-
INTERBUS standard round plug ¹⁾		■	-	-
INTERBUS "Rugged Line" FOC plug ¹⁾		-	-	■
Power supply				
Plug socket, straight, for 1.5 mm ²	NTSD-GD-9	■	■	-
Plug socket, straight, for 2.5 mm ²	NTSD-GD-13,5	■	■	-
Plug socket, angled, for 1.5 mm ²	NTSD-WD-9	■	■	-
Plug socket, angled, for 2.5 mm ²	NTSD-WD-11	■	■	-

1) Not a Festo product, order from Phoenix Contact

Product range overview – Electrical connection technology for modules					
Designation	Type	Input module		Output module	Input/output module
		4-/8-fold VIGE-... ?	16-fold VIGE-... ?	VIGA-... ?	VIEA-... ?
Plugs and sockets					
Plug, straight socket, M12, 4-pin, Pg7	SEA-GS-7	■	-	■	-
Plug, straight socket, M12, 4-pin, 2.5 mm ² OD	SEA-4GS-7-2,5	■	-	■	-
Plug, straight socket, M12, 5-pin, Pg7	SEA-M12-5GS-PG7 ¹⁾	■	-	■	-
Plug for 2 sensor cables, M12, Pg11, 4-pin	SEA-GS-11-DUO	■	-	■	-
Plug for 2 sensor cables, M12, Pg11, 5-pin	SEA-5GS-11-DUO ¹⁾	■	-	■	-
Plug socket Sub-D, plug	SD-SUB-D-ST15	-	■	-	-
Plug socket Sub-D, socket	SD-SUB-D-BU25	-	-	-	■
Cables					
Connecting cable, 5 m	KEA-1-25P-5	-	-	-	■
Connecting cable, 10 m	KEA-1-25P-10	-	-	-	■
Connecting cable, x length	KEA-1-25P-X	-	-	-	■
DUO cable, 2x straight socket	KM12-DUO-M8-GDGD	■	-	■	-
DUO cable, 2x straight/angled socket	KM12-DUO-M8-GDWD	■	-	■	-
DUO cable, 2x angled socket	KM12-DUO-M8-WDWD	■	-	■	-
Plug socket with cable, open at one end, 5 m	KMPV-SUB-D-15-5	-	■	-	-
Plug socket with cable, open at one end, 10 m	KMPV-SUB-D-15-10	-	■	-	-





1) 5-pin cable, cannot be used with 4-pin connectors

Product range overview – Electrical connection technology for modules		
Designation	Type	Analogue stage
		VIAU-... ?
Cables		
Connecting cable for Festo proportional pressure regulator, 5 m	KVIA-MPPE-5	■
Connecting cable for Festo proportional pressure regulator, 10 m	KVIA-MPPE-10	■
Connecting cable for Festo proportional directional control valve, 5 m	KVIA-MPYE-5	■
Connecting cable for Festo proportional directional control valve, 10 m	KVIA-MPYE-10	■
Connecting cable for other signal modules, open cable end, 5 m	KVIA-5	■
Connecting cable for other signal modules, open cable end, 10 m	KVIA-10	■

Modular electrical peripherals, for type 03/04

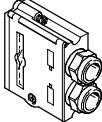

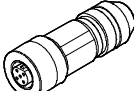
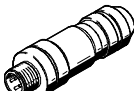
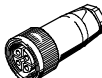
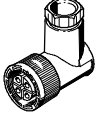
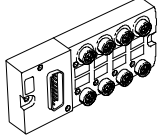
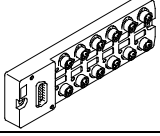

FESTO

Accessories

Ordering data				
Designation			Part No.	Type
Fieldbus connection				
	Plug socket Sub-D, IP65, 9-pin	for PROFIBUS DP	532216	FBS-SUB-9-GS-DP-B
	Bus connection socket, straight, Sub-D, 9-pin (B-coded, ReverseKey)	2xM12 adapter 5-pin for PROFIBUS DP	533118	FBA-2-M12-5POL-RK
	Socket M12x1, 5-pin, straight	for self-assembly of a connecting cable for FBA-2-M12-5POL-RK	1067905	NECU-M-B12G5-C2-PB
	Plug M12x1, 5-pin, straight	for self-assembly of a connecting cable for FBA-2-M12-5POL-RK	1066354	NECU-M-S-B12G5-C2-PB
Power supply				
	Plug socket, straight, M18x1	4-pin for 1.5 mm ²	18493	NTSD-GD-9
		4-pin for 2.5 mm ²	18526	NTSD-GD-13,5
	Plug socket, angled, M18x1	4-pin for 1.5 mm ²	18527	NTSD-WD-9
		4-pin for 2.5 mm ²	533119	NTSD-WD-11
Multi-pin distributors				
	15-pin plug Sub-D / 8x 3-pin M8 sockets	8 I/Os	177669	MPV-E/A08-M8
	15-pin plug Sub-D / 12x 3-pin M8 sockets	12 I/Os	177670	MPV-E/A12-M8
	15-pin connecting cable / 8x 5-pin M12 sockets	8 I/Os	177671	MPV-E/A08-M12

Modular electrical peripherals, for type 03/04

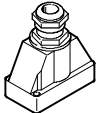
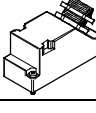
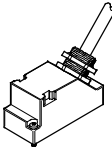
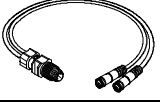
Accessories

Ordering data				
Designation			Part No.	Type
Plugs and sockets				
	Plug, straight socket, M12, 5-pin	5-pin, Pg7	175487	SEA-M12-5GS-PG7 ¹⁾
	Plug, straight socket, M12, 4-pin	4-pin, Pg7	18666	SEA-GS-7
		4-pin, Pg9	18778	SEA-GS-9
		2.5 mm ² OD	192008	SEA-4GS-7-2,5
	Plug for 2 sensor cables, M12	4-pin, Pg11	18779	SEA-GS-11-DUO
		5-pin, Pg11	192010	SEA-5GS-11-DUO ¹⁾
	Plug socket Sub-D, plug, 15-pin		192768	SD-SUB-D-ST15
	Plug socket Sub-D, socket, 25-pin		18709	SD-SUB-D-BU25
Cables				
	Connecting cable, 25-wire	5 m	177413	KEA-1-25P-5
		10 m	177414	KEA-1-25P-10
		x length	177415	KEA-1-25P-X
	DUO cable, straight plug, M12, 4-pin, 2xM12, 3-pin	2x straight socket	18685	KM12-DUO-M8-GDGD
		2x straight/angled socket	18688	KM12-DUO-M8-GDWD
		2x angled socket	18687	KM12-DUO-M8-WDWD
	Connecting cable for sensores, M12, 4-pin	1 m, straight plug, angled socket	185499	KM12-M12-GSWD-1-4
		2.5 m, straight plug, straight socket	18684	KM12-M12-GSGD-2,5
		5 m straight plug, straight socket	18686	KM12-M12-GSGD-5
	Connecting cable for sensores, M8, 3-pin	1 m, straight plug, straight socket	175489	KM8-M8-GSGD-1
		2.5 m, straight plug, straight socket	165610	KM8-M8-GSGD-2,5
		5 m, straight plug, straight socket	165611	KM8-M8-GSGD-5











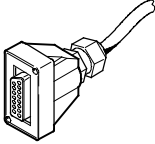
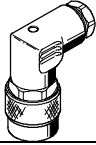
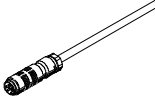
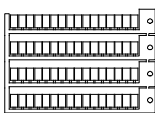

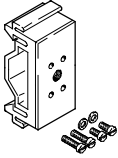
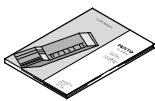

1) 5-pin cable, cannot be used with 4-pin connectors

- 1 - Type discontinued
Available up until 2017

Modular electrical peripherals, for type 03/04

FESTO

Accessories

Ordering data					
Designation			Part No.	Type	
Cables					
	Plug socket with cable, open at one end, 15-wire	5 m	177673	KMPV-SUB-D-15-5	
		10 m	177674	KMPV-SUB-D-15-10	
	Connecting cable for Festo proportional pressure regulator	5 m	163882	KVIA-MPPE-5	
		10 m	163883	KVIA-MPPE-10	
	Connecting cable for Festo proportional directional control valve	5 m	161984	KVIA-MPYE-5	
		10 m	161985	KVIA-MPYE-10	
	Connecting cable for other signal modules, open cable end	5 m	163960	KVIA-5	
		10 m	163961	KVIA-10	
Inscription labels and label holders					
	Inscription labels, 6x10, 64 pieces in frames		18576	IBS-6x10	
General accessories					
	Tamper proof cap (10 pieces) for unassigned connections	for MPV-E/A08-M12	165592	ISK-M12	
		for MPV-E/A...-M8	177672	ISK-M8	
	Mounting for H-rail, 2 pieces	for MPV-E/A...-M8	170169	CP-TS-HS-35	
Programming software					
	Programming software FST200 with manual for control block ISF3-03	German	165484	P.BE-FST200-AWL/KOP-DE	
		English	165489	P.BE-FST200-AWL/KOP-EN	
	User documentation – Bus node IFB8-03	German	152758	P.BE-VIFB8-03-DE	
		English	152768	P.BE-VIFB8-03/05-EN	
	User documentation – Bus node IFB11-03	German	163951	P.BE-VIFB11-03-DE	
		English	163956	P.BE-VIFB11-03-EN	
		French	163931	P.BE-VIFB11-03-FR	
		Italian	165431	P.BE-VIFB11-03-IT	
		Swedish	165461	P.BE-VIFB11-03-SV	
	User documentation – Bus node IFB16-03	German	164221	P.BE-VIFB16-03/05-DE	
		English	164222	P.BE-VIFB16-03/05-EN	
		Spanish	164223	P.BE-VIFB16-03/05-ES	
French		164224	P.BE-VIFB16-03/05-FR	