

Stopper cylinders STAF

FESTO



Stopper cylinders STAF

Key features

At a glance

- Single-acting or double-acting
- Versions
 - Roller
 - Toggle lever
- Direct mounting of solenoid valves on flange plate
- Fast and simple set-up of conveyor lines
- Workpiece carriers, pallets and packages weighing up to 150 kg can be safely stopped
- Gentle stopping without impact vibrations or noise with toggle lever version
- Simple actuation via valve terminal (e.g. in combination with other cylinders at an assembly station)
- Flanged solenoid valve permits fast actuation even over long distances and with individual stopper cylinders
- Space-saving sensing via integrated proximity sensors

Roller version



Toggle lever version



Mounting options

Flange mounting

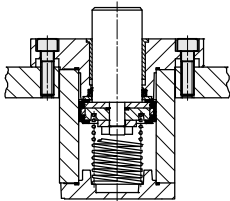

Application options and versions

For heavy masses

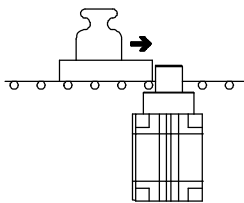

Safety

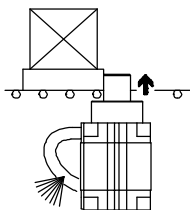

By means of spring return of the piston rod in the event of pressure failure.

Highly effective, low noise level

Toggle lever version with integrated shock absorber facilitates precise and gentle stopping of the workpiece carrier.

Stopper cylinders STAF

Product range overview

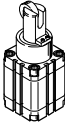
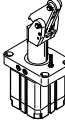
Function	Version	Type	Piston \varnothing [mm]	Stroke [mm]	Type of mounting via flange	Cushioning P	Position sensing A	→ Page/Internet
Single- or double- acting	Roller version							
		STAF-...-P-A-R	80	30, 40	■	■	■	4
	Toggle lever version							
		STAF-...-P-A-K	32	20	■	■	■	13

Stopper cylinders STAF, roller

Functional sequence and type codes

Functional sequence

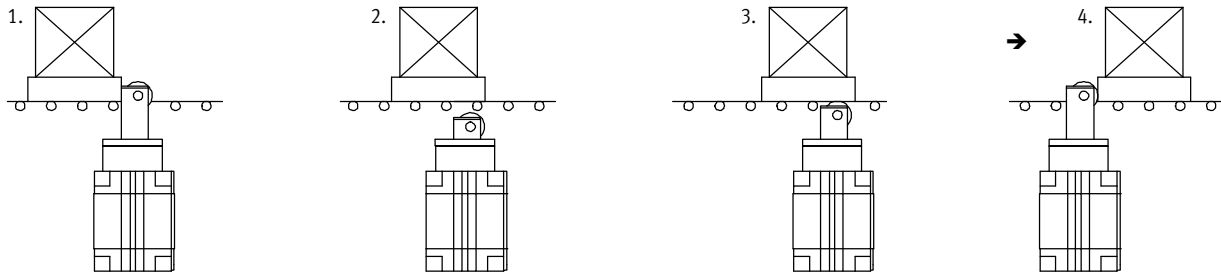

1. Sudden braking of the workpiece carrier via the piston rod.
2. The workpiece carrier is released by activating the cylinder.
3. The piston rod then advances by means of spring force or compressed air until the roller makes contact with the workpiece carrier. The workpiece carrier continues to move forward.
4. After the workpiece carrier has passed, the piston rod advances to the end position. The next workpiece carrier can then be stopped.

Type codes

		STAF	-	80	-	40	-	P	-	A	-	R
Type												
Single-acting or double-acting												
STAF	Stopper cylinder with flange mounting											
Piston Ø [mm]												
Stroke [mm]												
Cushioning												
P	Flexible cushioning rings/pads at both ends											
Position sensing												
A	Via proximity sensor											
Version												
R	Roller version											

Stopper cylinders STAF, roller

Peripherals overview

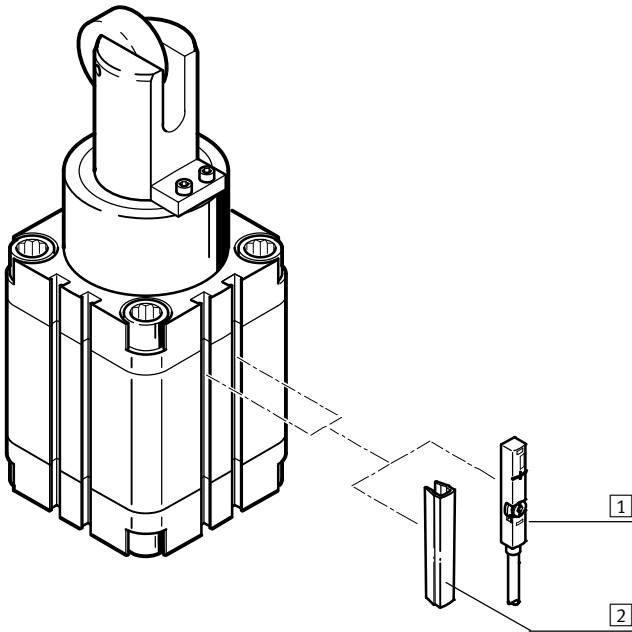

Accessories		
	Brief description	→ Page/Internet
1	Proximity sensor SME/SMT-8	Can be integrated in the cylinder profile barrel 21
2	Slot cover ABP	For protecting against ingress of dirt 21



Stopper cylinders STAF, roller

Technical data

FESTO

Function



-  - Diameter
80 mm
-  - Stroke length
30, 40 mm
-  - www.festo.com

-  - Note

Contact with liquids must be avoided during use.



General technical data		
Pneumatic connection		G ¹ / ₈
Stroke	[mm]	30, 40
Piston rod \varnothing	[mm]	50
Operating pressure	[bar]	1 ... 10
Operating medium		Compressed air in accordance with ISO 8573-1:2010 [7:-:-]
Constructional design		Piston cylinder with spring return
Cushioning		Flexible cushioning rings/pads at both ends
Position sensing		Via proximity sensor
Type of mounting		Via through-holes
		Via female thread
Mounting position		Any
Mode of operation		Single-acting or double-acting
Protection against rotation		Flat-sided piston rod
Ambient temperature ¹⁾	[°C]	0 ... +60
Product weight	[g]	4,630, 4,850

1) Note operating range of proximity sensors.

-  - Note: This product conforms to ISO 1179-1 and to ISO 228-1

Forces [N]		
Piston \varnothing	80	
Stroke	30	40
Permissible impact force on the advanced piston rod	14,600	13,300
Spring force	79 ... 115	101 ... 170

Under "impact force" we understand the maximum of a force-time curve during impact/braking of the moveable mass. It is effective vertical to the movement axis of the piston rod. If one regards the elastic components as linear springs, the permitted impact energy can be calculated from the

permitted impact force. This serves for selecting the correct stopper.

The stopper must not switch under this force. Depending on the mass to be stopped, it may be advisable to provide an elastic buffer in order to cushion the impact, to reduce noise and to optimize the impact energy.

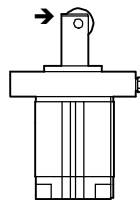

→ = Direction of impact force

Stopper cylinders STAF, roller

Technical data

Permissible mass m as a function of the conveyor speed v

The values in the graph opposite are based on the assumption that the workpiece carrier is fitted with a flexible buffer with a deformation path of 1 mm.

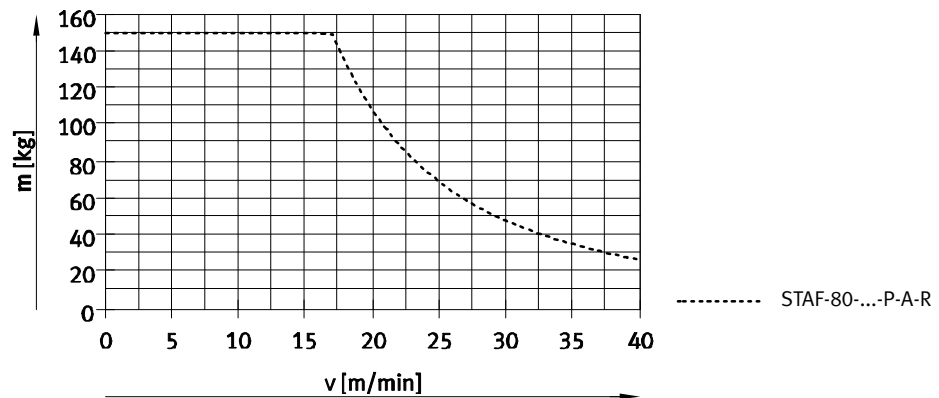

Permissible transverse force F_Q during the switching operation as a function of the pressure p

Under "permitted lateral force" during the switching procedure, we understand the force which still exists vertical to the direction of movement of the piston rod after the impact or braking procedure, e.g. by bands still running or the slope power take-off force of an inclined rolling surface. The force is effective statically. The stopper must not switch under this force. In order that the functioning of the cylinder can be guaranteed, a certain minimum pressure must be applied.

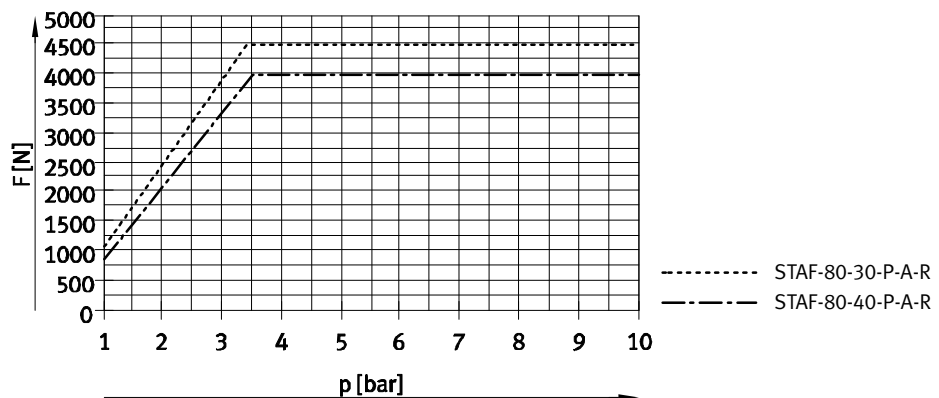

Note
Selection aid → 9

Materials

Sectional view

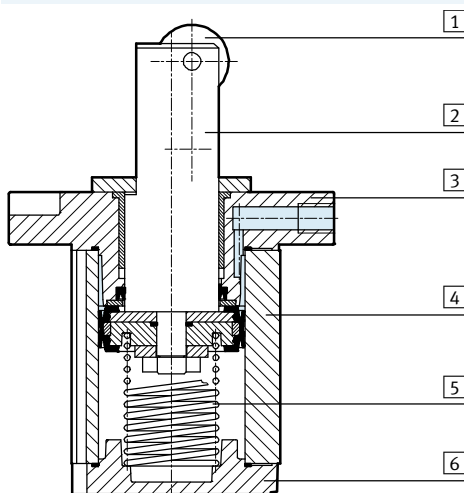

Stopper cylinder		
1	Roller	Steel
2	Piston rod	Stainless steel
3	Flange	Die-cast aluminium
4	Cylinder barrel	Anodised aluminium
5	Springs	Spring steel
6	End cap	Anodised aluminium
-	Seals	NBR
-	Note on materials	Free of copper and PTFE

Stopper cylinders STAF, roller

Technical data

FESTO

Dimensions

Download CAD data → www.festo.com

Flange mounting

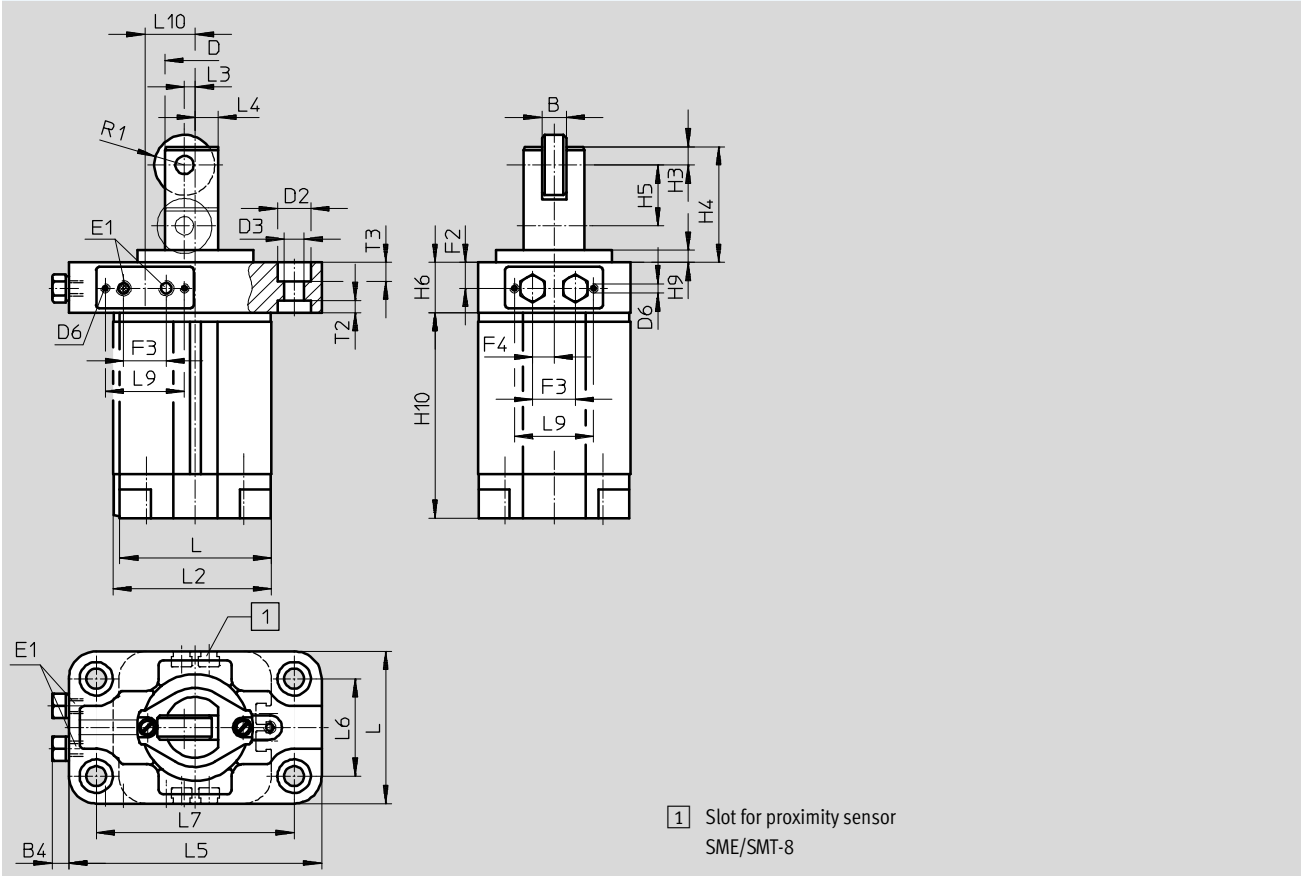

∅	Stroke	B	B4	D	D2	D3	D6	E1	F2	F3	F4	H3	H4	H5	H6
[mm]	[mm]			∅	∅	∅									
80	30	18	4.5	50	18	11	M4	G1/8	11	17	4.5	10	63	30	22
	40												73	40	

∅	Stroke	H9	H10	L	L2	L3	L4	L5	L6	L7	L9	L10	R1	T2	T3
[mm]	[mm]														
80	30	8	119	107	111	11	18	160	63	135	36	18.5	18	6	6
	40		129												

Note: This product conforms to ISO 1179-1 and to ISO 228-1

Ordering data

Piston ∅	Stroke	Part No.	Type
[mm]	[mm]		
80	30	164886	STAF-80-30-P-A-R
	40	164894	STAF-80-40-P-A-R

Stopper cylinders STAF

Technical data

Selection aid

Stopping a workpiece carrier

The stopper cylinder is used to brake an individual workpiece carrier.

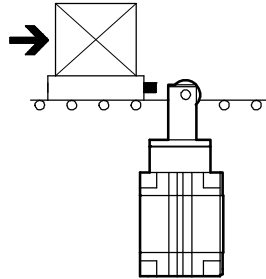

Example

Given:

Friction value $\mu = 0.1$

Delivery speed $v = 10 \text{ m/min}$

Workpiece carrier with workpiece $m = 40 \text{ kg}$

Operating pressure $p = 6 \text{ bar}$

Choice: Stopper cylinder STAF-80-30-P-A-R

1. Checking the permissible mass

The maximum permissible mass at a delivery speed of 10 m/min is 150 kg. This means that the total mass of the workpiece carrier and workpiece of 40 kg is permissible.

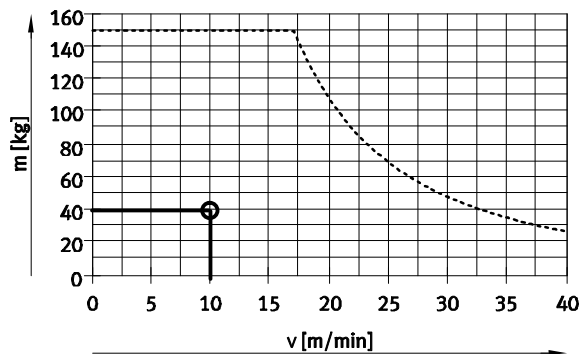

----- STAF-80-...-P-A-R

2. Checking the permissible transverse force during the switching operation

Transverse force $F_Q =$ friction force

F_{Friction}

$$F_{\text{Friction}} = \mu \times m \times g$$

$$= 0.1 \times 40 \text{ kg} \times 9.81 \text{ m/s}^2$$

$$= \text{approx. } 40 \text{ N}$$

The maximum permissible transverse force at an operating pressure of 6 bar is 4,500 N.

This means that the transverse force of 40 N is permissible.

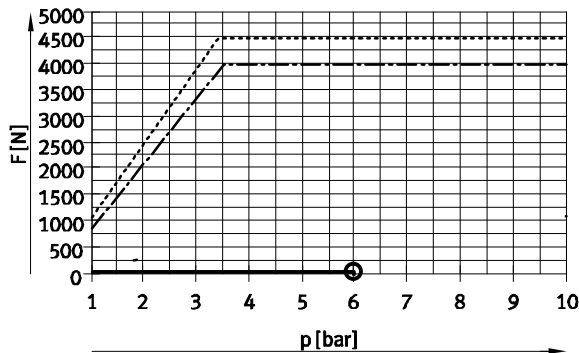

----- STAF-80-30-P-A-R
 ----- STAF-80-40-P-A-R

Stopper cylinders STAF

Technical data

Selection aid

Stopping or separating several workpiece carriers

The stopper cylinder is used to separate workpiece carriers. Further workpiece carriers accumulate behind carriers already at the stopper cylinder. It is vital that a buffer is mounted between the workpiece carriers (e.g. elastomer elements).

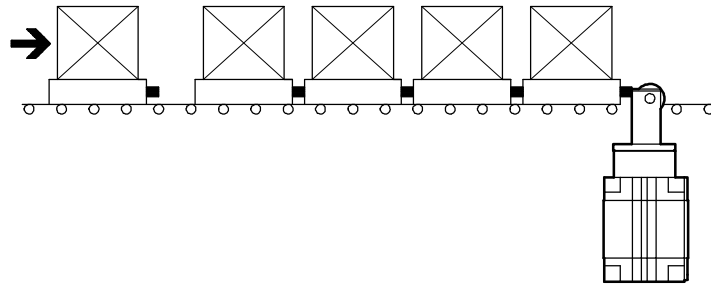

Example

Given:

Friction value $\mu = 0.1$

Delivery speed $v = 10 \text{ m/min}$

Workpiece carrier with workpiece $m = 40 \text{ kg}$

Operating pressure $p = 6 \text{ bar}$

Maximum number of workpiece carriers accumulating simultaneously $n_{\text{Group}} = 1$

Maximum number of all queued workpiece carriers $n_{\text{Queue}} = 5$

Maximum number of all advancing workpiece carriers $n_{\text{Queue-1}} = 4$

Spring travel of the workpiece carrier buffer $s_F = 1 \text{ mm}$

Choice: Stopper cylinder STAF-R

1. Checking the permissible mass of the first workpiece carrier

The maximum permissible mass at a delivery speed of 10 m/min is 150 kg. This means that the total mass of the workpiece carrier and workpiece of 40 kg is permissible.

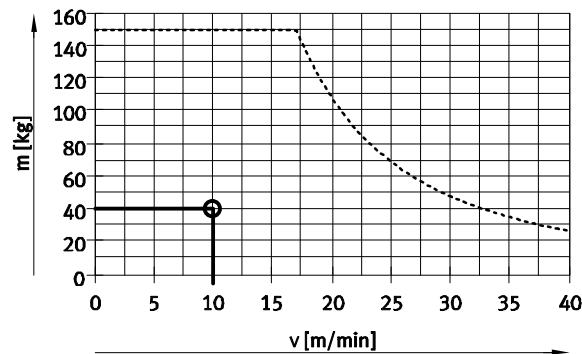

----- STAF-80-...-P-A-R

2a. Calculation of the maximum permissible impact force when workpiece carriers accumulate behind a carrier at the stopper cylinder

With the STAF-80, the maximum permissible impact force is 14,600 N. This means that with a total force of 1,300 N, the number of workpiece carriers is permissible.

Impact force calculation:

$$F_{\text{Impact}} = \frac{(n_{\text{Group}} \times m) \times v^2}{s_F} = \frac{(1 \times 40\text{kg}) \times (10\text{m}/60\text{s})^2}{0.001\text{m}} = \text{ca.}1100\text{N}$$

Friction force:

$$F_{\text{Friction}} = \mu \times (n_{\text{Queue}} \times m) \times g = 0.1 \times (5 \times 40\text{kg}) \times 9.81\text{m/s}^2 = \text{ca.}200\text{N}$$

Max. total force:

$$F_{\text{Total force}} = F_{\text{Impact}} + F_{\text{Friction}} = 1100\text{N} + 200\text{N} = 1300\text{N}$$

Stopper cylinders STAF

Technical data

Selection aid

2b. Checking the permissible transverse force during the switching operation

Transverse force $F_Q =$
friction force F_{Friction}
 $F_{\text{Friction}} = 200 \text{ N}$

The maximum permissible transverse force at an operating pressure of 6 bar is 4,500 N.

This means that the transverse force of 200 N is permissible.

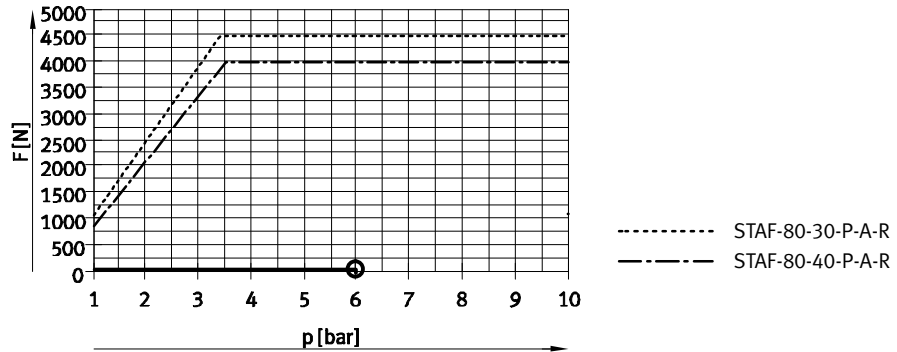

3. Separating and advancing the workpiece carriers

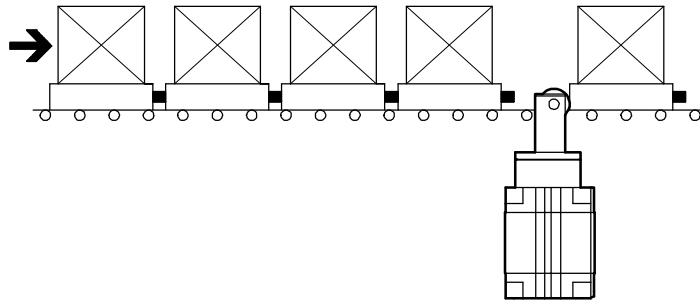

The maximum permissible mass with the STAF-80-30-P-A-R at a delivery speed of 10 m/min is 150 kg.
The total load of the 4 pallets advancing on the stopper cylinder is 160 kg.

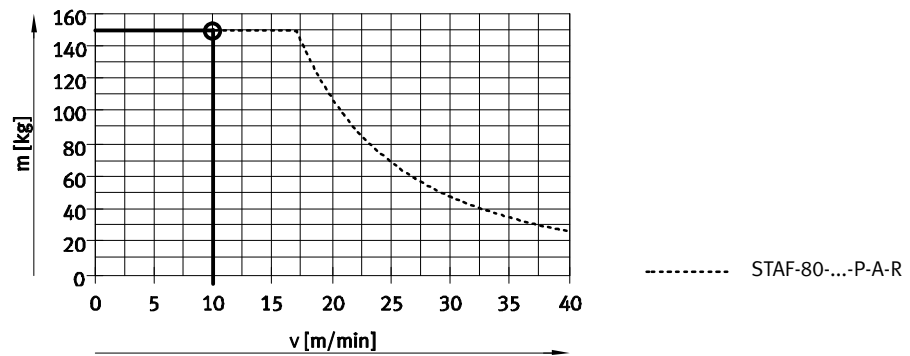

Max. total mass:

$$m_{\text{Total force}} = n_{\text{Queue}-1} \times m = 4 \times 40\text{kg} = 160\text{kg}$$

Result

When using stopper cylinders STAF-80-30-P-A-R, max. 2 advancing pallets may accumulate simultaneously.

Max. total mass:

$$m_{\text{Total force}} = n_{\text{Queue}-1} \times m = 2 \times 40\text{kg} = 80\text{kg}$$

Stopper cylinders STAF

Technical data

FESTO

Application example



Stopper cylinders STAF, toggle lever

Functional sequence

Functional sequence

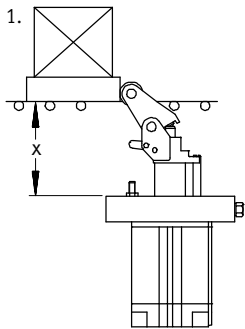

1. Gentle stopping of heavy masses via a hydraulic shock absorber in the piston rod.

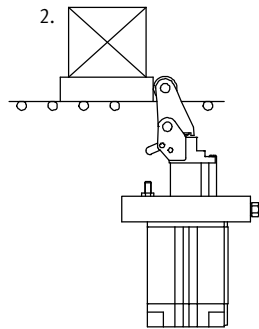

2. The toggle lever is locked into the retracted end position so that the workpiece carrier cannot be pushed back by the shock absorber.

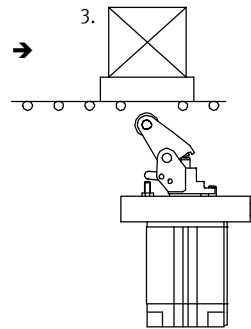

3. The workpiece carrier is released by means of compressed air, and the toggle lever is released simultaneously.

X = 62.8 ... 63.4 mm

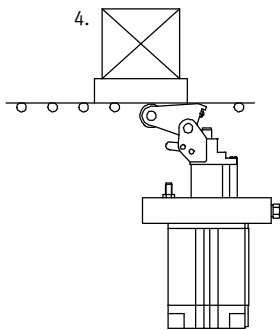

4. The piston is advanced by means of spring force or compressed air. The toggle lever tips back which prevents the workpiece carrier from being pushed up.

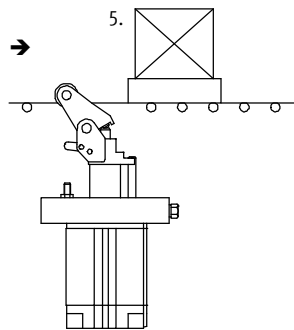

5. The toggle lever is raised by means of spring force and stops the next workpiece carrier.

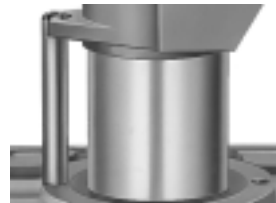

Protection against rotation:
The guide rod always aligns the toggle lever precisely to the approaching workpiece carrier.



Integrated shock absorber: absorbs impact energy and stops the workpiece carrier gently, and with low noise levels.
The impact energy can be adjusted using the regulating screw in the toggle lever.



Detenting roller lever: the workpiece carrier cannot be pushed back by the shock absorber.



Locking mechanism for disabling the stopper function: the workpiece carrier is able to pass the holding point without activating the cylinder.



Note

Roller type stopper cylinders can be mounted in any position.
Stopper cylinders with toggle lever must be mounted in the vertical, upright position.

Stopper cylinders STAF, toggle lever

Key features



Mounting options for solenoid valves and valve functions

An MEH, MEBH, MOEH or MOEBH solenoid valve can be mounted on the stopper cylinder for quick, direct actuation of the cylinder. The valve must be mounted on the flange plate via a valve sub-base ZVA. The position of the piston rod when the solenoid valve is in the normal position depends upon the valve type and the position of the valve on the cylinder.

Application	Piston rod in initial position	Required solenoid valve	Type of mounting for the solenoid valve with sub-base ZVA
	Single-acting 	Normally advanced 173125 MEH-3/2-5,0-B 172999 MEBH-3/2-5,0-B	
		Normally retracted 173429 MOEH-3/2-5,0-B 173002 MOEBH-3/2-5,0-B	
	Double-acting 	Normally advanced 173128 MEH-5/2-5,0-B 173005 MEBH-5/2-5,0-B	
		Normally retracted 173128 MEH-5/2-5,0-B 173005 MEBH-5/2-5,0-B	

Note
 Cylinders are always supplied single-acting with spring. If a double-acting stopper cylinder is required, the filter nipple in the exhaust port must be removed. The exhaust port is then used as a supply port.
 Solenoid valves MEH, MEBH
 → Internet: solenoid valve

Stopper cylinders STAF, toggle lever

Type codes and peripherals overview

STAF		32	20	P	A	K
Type						
Single-acting or double-acting						
STAF	Stopper cylinder with flange mounting					
Piston Ø [mm]						
Stroke [mm]						
Cushioning						
P	Flexible cushioning rings/pads at both ends					
Position sensing						
A	Via proximity sensor					
Version						
K	Toggle lever version					

Peripherals overview

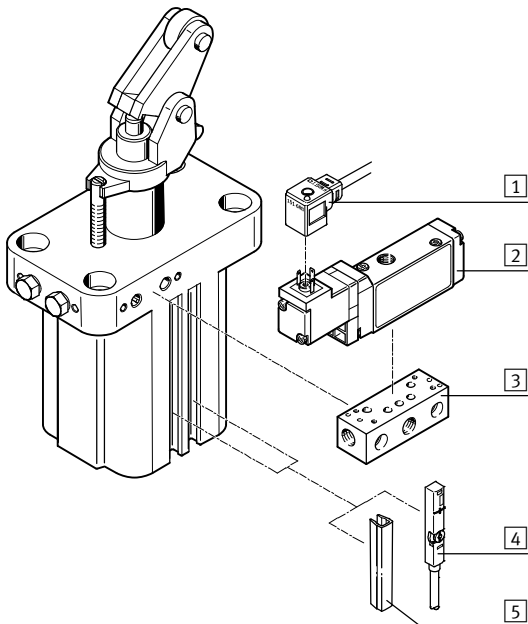

Accessories		
	Brief description	→ Page/Internet
1	Plug socket with cable KMEB	kmeb
2	3/2-way valve MEBH	mebh
3	Sub-base ZVA	19
4	Proximity sensor SME/SMT-8	21
5	Slot cover ABP	21

Stopper cylinders STAF, toggle lever

Technical data

FESTO



Function



-  - Note

Contact with liquids must be avoided during use.



-  - Diameter
32 mm
-  - Stroke length
20 mm
-  - www.festo.com

General technical data		
Pneumatic connection		M5
Stroke	[mm]	20
Piston rod \varnothing	[mm]	20
Operating pressure	[bar]	1.5 ... 10
Operating medium		Compressed air in accordance with ISO 8573-1:2010 [7:--:-]
Constructional design		Piston cylinder with spring return
Cushioning		Flexible cushioning rings/pads at both ends
Position sensing		Via proximity sensor
Type of mounting		Via through-holes
Mounting position		Vertical, upright
Mode of operation		Single-acting or double-acting
Protection against rotation		Guide rod
Ambient temperature ¹⁾	[°C]	0 ... +60
Product weight	[g]	710

1) Note operating range of proximity sensors.

-  - Note: This product conforms to ISO 1179-1 and to ISO 228-1

Forces [N]	
Permissible impact force on the rollers of the toggle lever when the piston rod is advanced and the toggle lever is pushed into its end position	480
Spring force	20 ... 42

Impact force is the basis for the calculation of permissible impact energy. Depending upon the type of load to be stopped, it is advisable to use a flexible buffer to cushion the impact, reduce noise levels and to optimise impact energy.

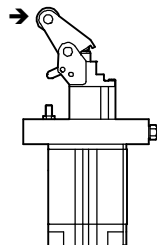

→ = Direction of impact force

Stopper cylinders STAF, toggle lever

Technical data

Permissible mass m as a function of the conveyor speed v

With a friction value of $\mu = 0.1$

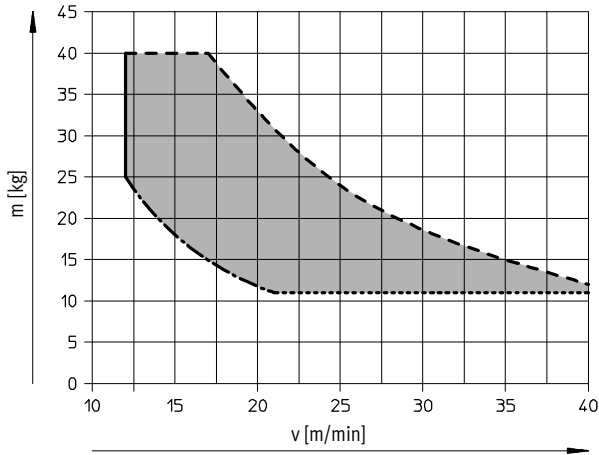

Note

The required mass for reliable pushing into the end position is dependent on the friction pairing between the conveyor and conveyed goods, other friction values on request.

Cushioning time is increased for partial loads.
Energy values valid for ambient temperature $T = 20\text{ }^{\circ}\text{C}$.

- Operating range
- Max. workload
- Recommended minimum workload¹⁾
- Required mass²⁾

- 1) For optimum operation of the damper
- 2) Required mass for reliable pushing of the toggle lever into the end position with this friction value

Materials

Sectional view

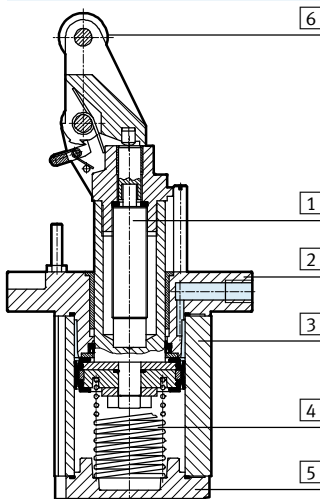

Stopper cylinder

1	Piston rod	Stainless steel
2	Flange	Die-cast aluminium
3	Cylinder barrel	Anodised aluminium
4	Springs	Spring steel
5	End cap	Anodised aluminium
6	Roller	POM
-	Seals	NBR
-	Note on materials	Free of copper and PTFE

Minimum distance to the conveyor

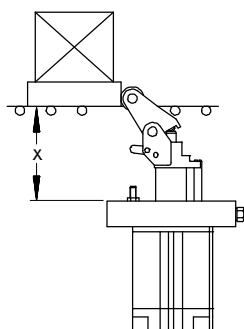

$X = 62.8 \dots 63.4\text{ mm}$

Stopper cylinders STAF, toggle lever

Technical data

FESTO

Dimensions

Download CAD data → www.festo.com

Flange mounting

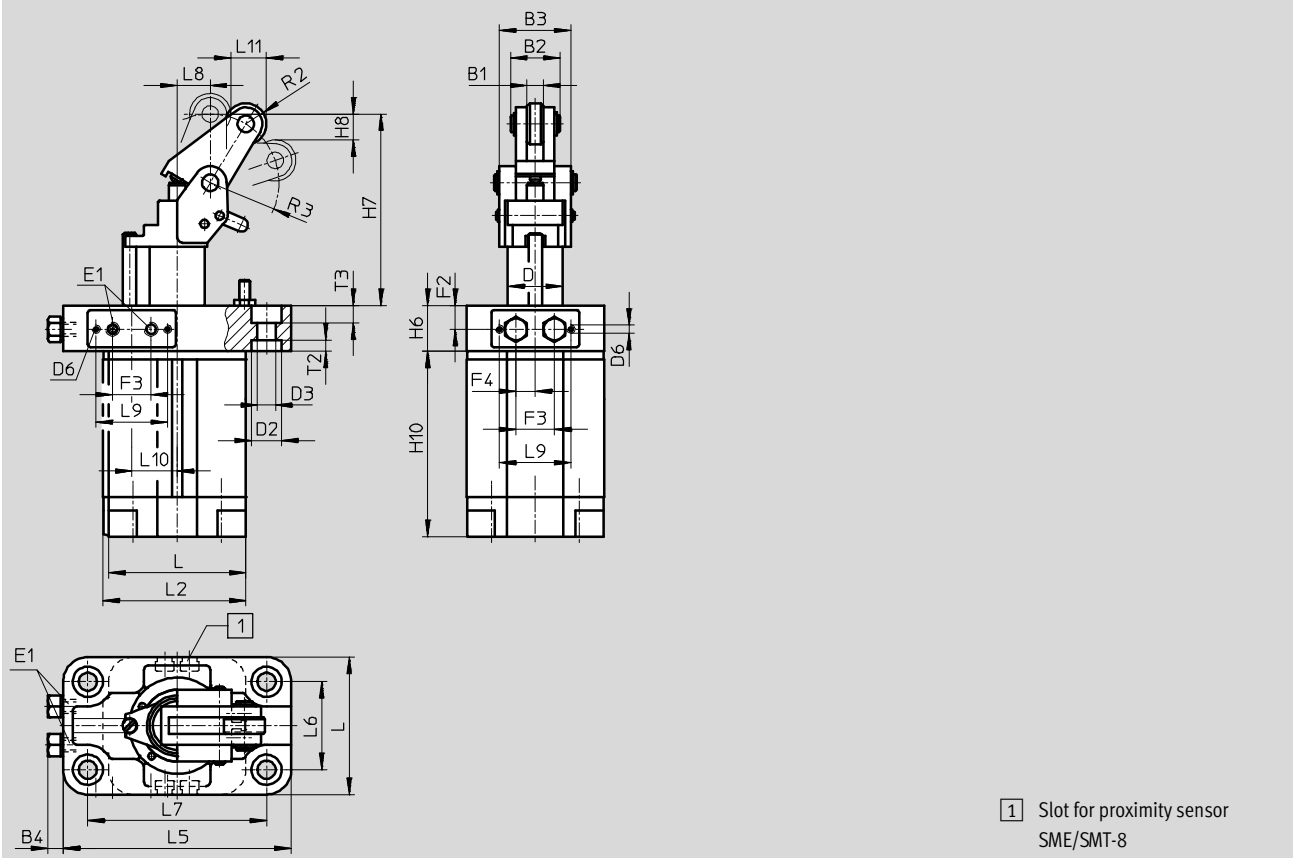

∅	B1	B2	B3	B4	D	D2	D3	D6	E1	F2	F3	F4	H6	H7	H8
[mm]					∅	∅	∅								
32	6	18	26	4.5	20	11	6.6	M3	M5	8.5	14	7	16.5	70	9.5

∅	H10	L	L2	L5	L6	L7	L8	L9	L10	L11	R2	R3	T2	T3
[mm]														
32	67.5	50	52	83	32	65	12	26	16.5	13	7.5	25	4	6.2

– Note: This product conforms to ISO 1179-1 and to ISO 228-1

Ordering data

Piston ∅ [mm]	Stroke [mm]	Part No.	Type
32	20	164880	STAF-32-20-P-A-K

Stopper cylinders STAF

Accessories

Sub-base ZVA

for stopper cylinder with flange

Material:

Wrought aluminium alloy

Free of copper and PTFE

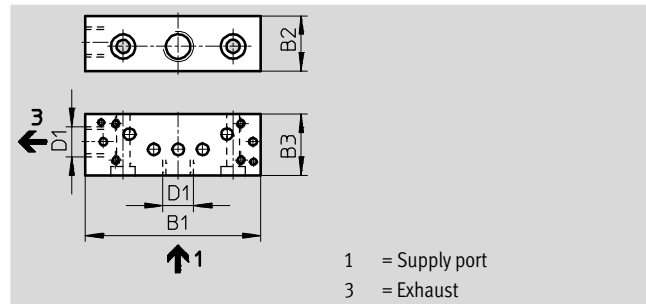
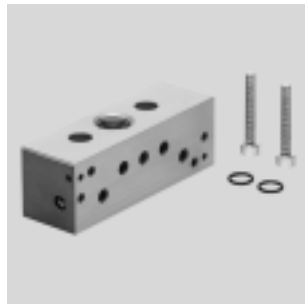

Dimensions and ordering data								
For Ø	B1	B2	B3	D1	CRC ¹⁾	Weight	Part No.	Type
[mm]						[g]		
32	56	18	20	G ¹ / ₈	2	50	164896	ZVA-1
80	57.5	18	20	G ¹ / ₈	2	52	164897	ZVA-2

1) Corrosion resistance class 2 as per Festo standard 940 070
Components subject to moderate corrosion stress. Externally visible parts with primarily decorative surface requirements which are in direct contact with a normal industrial environment or media such as coolants or lubricating agents.

Stopper cylinders STAF

Accessories

FESTO

Dimensions

Download CAD data → www.festo.com

Mounting dimensions for solenoid valves with sub-base ZVA on stopper cylinders

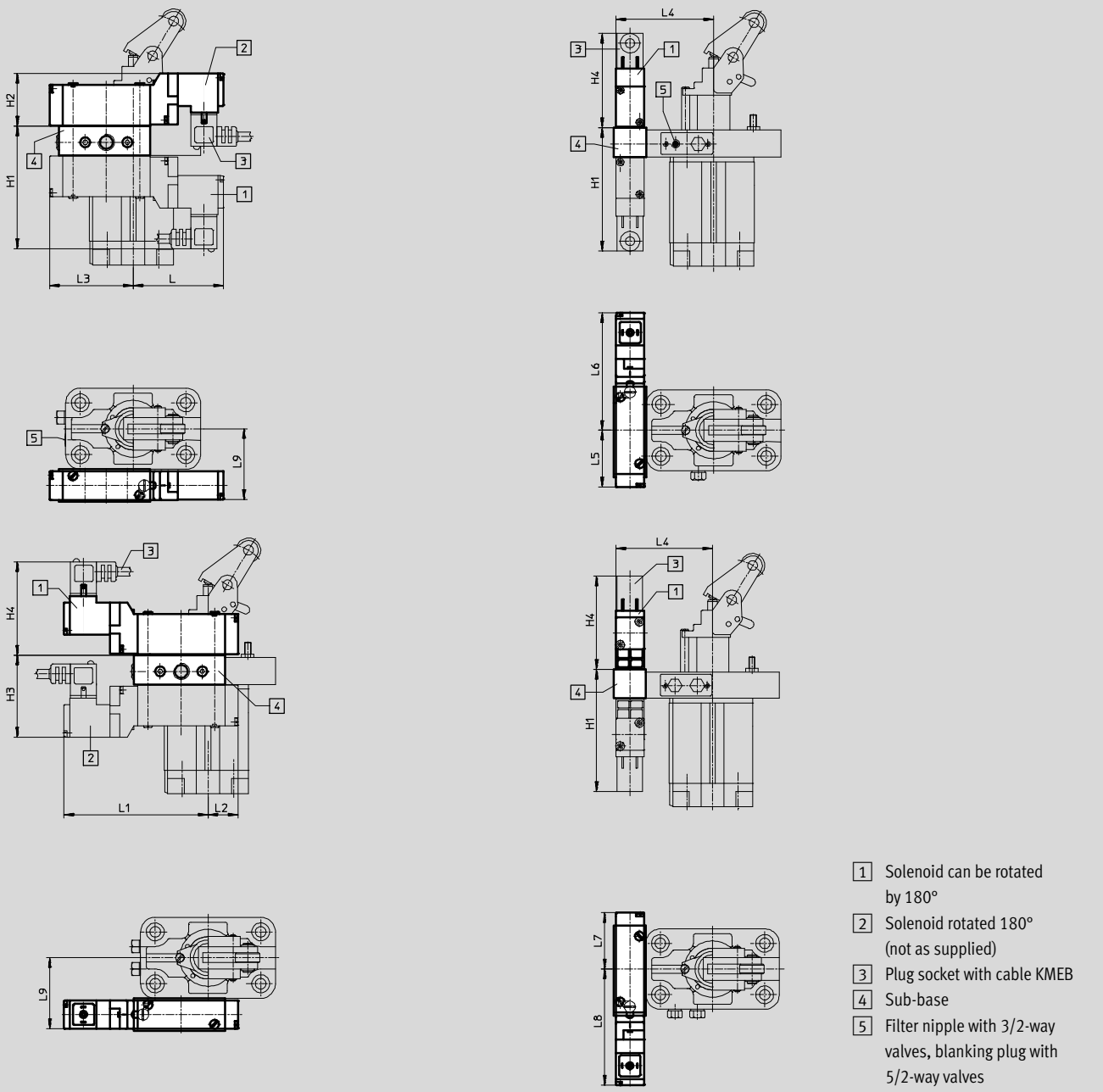

For Ø [mm]	L	L1	L2	L3	L4	L5	L6
32	55.5	88.5	18.5	51.5	59	35	72
80	48.5	95.5	11.5	58.5	98	39	68



For Ø [mm]	L7	L8	L9	H1	H2	H3	H4
32	35	72	42	74.5	33.5	48.5	59.5
80	31	76	71	79	29	53	56

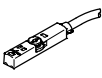
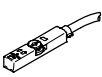

Stopper cylinders STAF

Accessories

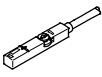
FESTO

Ordering data – Proximity sensors for T-slot, magneto-resistive						Technical data → Internet: smt	
	Type of mounting	Switch output	Electrical connection	Cable length [m]	Part No.	Type	
N/O contact							
	Insertable in the slot from above, flush with cylinder profile, short design	PNP	Cable, 3-wire	2.5	574335	SMT-8M-A-PS-24V-E-2,5-OE	
			Plug M8x1, 3-pin	0.3	574334	SMT-8M-A-PS-24V-E-0,3-M8D	
			Plug M12x1, 3-pin	0.3	574337	SMT-8M-A-PS-24V-E-0,3-M12	
		NPN	Cable, 3-wire	2.5	574338	SMT-8M-A-NS-24V-E-2,5-OE	
			Plug M8x1, 3-pin	0.3	574339	SMT-8M-A-NS-24V-E-0,3-M8D	
N/C contact							
	Insertable in the slot from above, flush with cylinder profile, short design	PNP	Cable, 3-wire	7.5	574340	SMT-8M-A-PO-24V-E-7,5-OE	

Ordering data – Proximity sensors for T-slot, magnetic reed						Technical data → Internet: sme		
	Type of mounting	Switch output	Electrical connection	Cable length [m]	Part No.	Type		
N/O contact								
	Insertable in the slot from above, flush with cylinder profile	Contacting	Cable, 3-wire	2.5	543862	SME-8M-DS-24V-K-2,5-OE		
				5.0	543863	SME-8M-DS-24V-K-5,0-OE		
			Plug M8x1, 3-pin	Cable, 2-wire	2.5	543872	SME-8M-ZS-24V-K-2,5-OE	
				0.3	543861	SME-8M-DS-24V-K-0,3-M8D		
	Insertable in the slot lengthwise, flush with the cylinder profile	Contacting	Cable, 3-wire	2.5	150855	SME-8-K-LED-24		
			Plug M8x1, 3-pin	0.3	150857	SME-8-S-LED-24		
N/C contact								
	Insertable in the slot lengthwise, flush with the cylinder profile	Contacting	Cable, 3-wire	7.5	160251	SME-8-0-K-LED-24		

Ordering data – Connecting cables					Technical data → Internet: nebu	
	Electrical connection, left	Electrical connection, right	Cable length [m]	Part No.	Type	
	Straight socket, M8x1, 3-pin	Cable, open end, 3-wire	2.5	541333	NEBU-M8G3-K-2.5-LE3	
			5	541334	NEBU-M8G3-K-5-LE3	
	Angled socket, M8x1, 3-pin	Cable, open end, 3-wire	2.5	541338	NEBU-M8W3-K-2.5-LE3	
			5	541341	NEBU-M8W3-K-5-LE3	

Ordering data – Slot cover for T-slot					
	Assembly	Length [m]	Part No.	Type	
	Insertable from above	2x 0.5	151680	ABP-5-S	