

Proximity sensors SMT/SME-10, for C-slot



# Proximity sensors SMT/SME

Product range overview

| Design  | Type of mounting  | Measuring principle | Type              | Operating voltage range | Switching output    | Switching element function | → Page/ Internet |
|---|---|---------------------|-------------------|-------------------------|---------------------|----------------------------|------------------|
| <b>For C-slot</b>   | Standard  |                     |                   |                         |                     |                            |                  |
|   | Insertable in slot from above, flush with cylinder profile  | Magneto-resistive   | SMT-10M           | 5 ... 30 V DC           | PNP                 | N/O contact                | 6                |
|   |   |                     |                   |                         | NPN                 |                            |                  |
|   | Insertable in slot length-wise                              | Magnetic reed       | SME-10M           | 5 ... 30 V AC/DC        | Contacting, bipolar | N/O contact                | 11               |
|   |   | Magneto-resistive   | SMT-10G           | 10 ... 30 V DC          | PNP                 | N/O contact                | 21               |
|   | Magnetic reed   | SME-10              | 12 ... 27 V AC/DC | Contacting              | N/O contact         | 17                         |                  |
| <b>For T-slot</b>   | Standard  |                     |                   |                         |                     |                            |                  |
|   | Insertable in slot from above, flush with cylinder profile  | Magneto-resistive   | SMT-8M            | 10 ... 30 V DC          | PNP                 | N/O contact                | t-slot           |
|   |   |                     |                   |                         | NPN                 | N/C contact                |                  |
|   |   | Magnetic reed       | SME-8M            | 5 ... 30 V AC/DC        | Contacting, bipolar | N/O contact                |                  |
|   |   |                     |                   |                         |                     | N/C contact                |                  |
|   | Insertable in slot length-wise, flush with cylinder profile | Magneto-resistive   | SMT-8             | 10 ... 30 V DC          | PNP                 | N/O contact                |                  |
|   |   |                     |                   |                         | NPN                 |                            |                  |
|   | Insertable in slot length-wise, flush with cylinder profile | Magnetic reed       | SME-8             | 12 ... 30 V AC/DC       | Contacting, bipolar | N/O contact                |                  |
|   |   |                     |                   | 3 ... 230 V AC/DC       |                     | N/C contact                |                  |
|   |   |                     |                   | 5 ... 250 V AC/DC       |                     | N/O contact                |                  |
|   | Insertable in slot length-wise                              | Magneto-resistive   | SMT-8G            | 10 ... 30 V DC          | PNP                 | N/O contact                |                  |
|   |   | Magneto-resistive   | SMT-8-SL          | 10 ... 30 V DC          | PNP                 | N/O contact                |                  |
|   |   | Magnetic reed       | SME-8-SL          | 10 ... 30 V AC/DC       | Contacting, bipolar | N/O contact                |                  |
|   | Insertable in slot from above                               | Magnetic reed       | SME-8-FM          | 10 ... 30 V AC/DC       | Contacting, bipolar | N/O contact                |                  |
|   | Via accessories   | Magneto-resistive   | SMT0-8E           | 10 ... 30 V DC          | PNP                 | N/O contact                |                  |
|   |   |                     |                   |                         | NPN                 |                            |                  |
|   |   | Magnetic reed       | SME0-8E           | 12 ... 30 V DC          | Contacting, bipolar | N/O contact                |                  |
|   |   |                     |                   | 3 ... 250 V DC          |                     |                            |                  |
|   |   |                     |                   | 3 ... 230 V AC          |                     |                            |                  |
|   | Corrosion resistant   |                     |                   |                         |                     |                            |                  |
|   | Insertable in slot length-wise, flush with cylinder profile | Magneto-resistive   | CRSMT-8           | 10 ... 30 V DC          | PNP                 | N/O contact                | t-slot           |
|   | Welding field immune  |                     |                   |                         |                     |                            |                  |
|   | Via accessories   | Magneto-inductive   | SMTSO-8E          | 10 ... 30 V DC          | PNP                 | N/O contact                | t-slot           |
|   |   |                     |                   | NPN                     |                     |                            |                  |
| Heat resistant up to 120 °C                                 |   |                     |                   |                         |                     |                            |                  |
| Insertable in slot length-wise, flush with cylinder profile | Magnetic reed   | SME-8-...-S6        | 0 ... 30 V AC/DC  | Contacting, bipolar     | N/O contact         | t-slot                     |                  |
| Via accessories   | Magnetic reed   | SME0-8E-...-S6      | 0 ... 30 V DC     | Contacting              | N/O contact         | t-slot                     |                  |
|   |   |                     | 0 ... 30 V AC     |                         |                     |                            |                  |

# Proximity sensors SMT/SME

Product range overview

## For gears used with T-slot are T-Nut switcher adaptable

Exceptions to

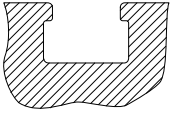

- DFM-B: SMT0-8E, SMTSO-8E, SME0-8E, SMPO-8E not adaptable
- DHDS: SME-8M only for  $\varnothing$  50 adaptable
- DHPS: SME-8M only for  $\varnothing$  20 ... 35 adaptable
- HGDD-63-A: SMT-8M-A not adaptable
- HGPT-B: SMT-8G can only be used from size 40 upwards
- SDBT-BSW- ... -PU/NU can only be used on a limited number of drive series

## For gears used with C-slot are C-slot switcher adaptable

Exceptions to

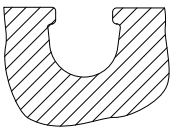

- ADVC  $\varnothing$  100: SMT-10M and SME-10M not adaptable (ADVC within T-slot and C-slot equipped)
- DSM/DSM-B-6/8/10: SME-10M not adaptable
- DSM/DSM-B-10/16: SMT-10M not adaptable
- HGPT-B: SMT-10G can only be used up to size 35

## For drives with sensor rail: these are available with 2 cylinder barrel contours

Only T-slot sensors CRSMT-8M and SMT-8M-A can be used, and only with the profile identified below as being suitable

Example: DSBF

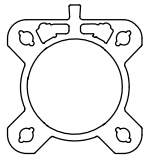

Suitable

Example: CDC

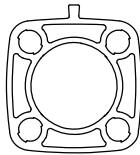

Not suitable

# Proximity sensors SMT/SME-10, for C-slot

Overview of peripherals

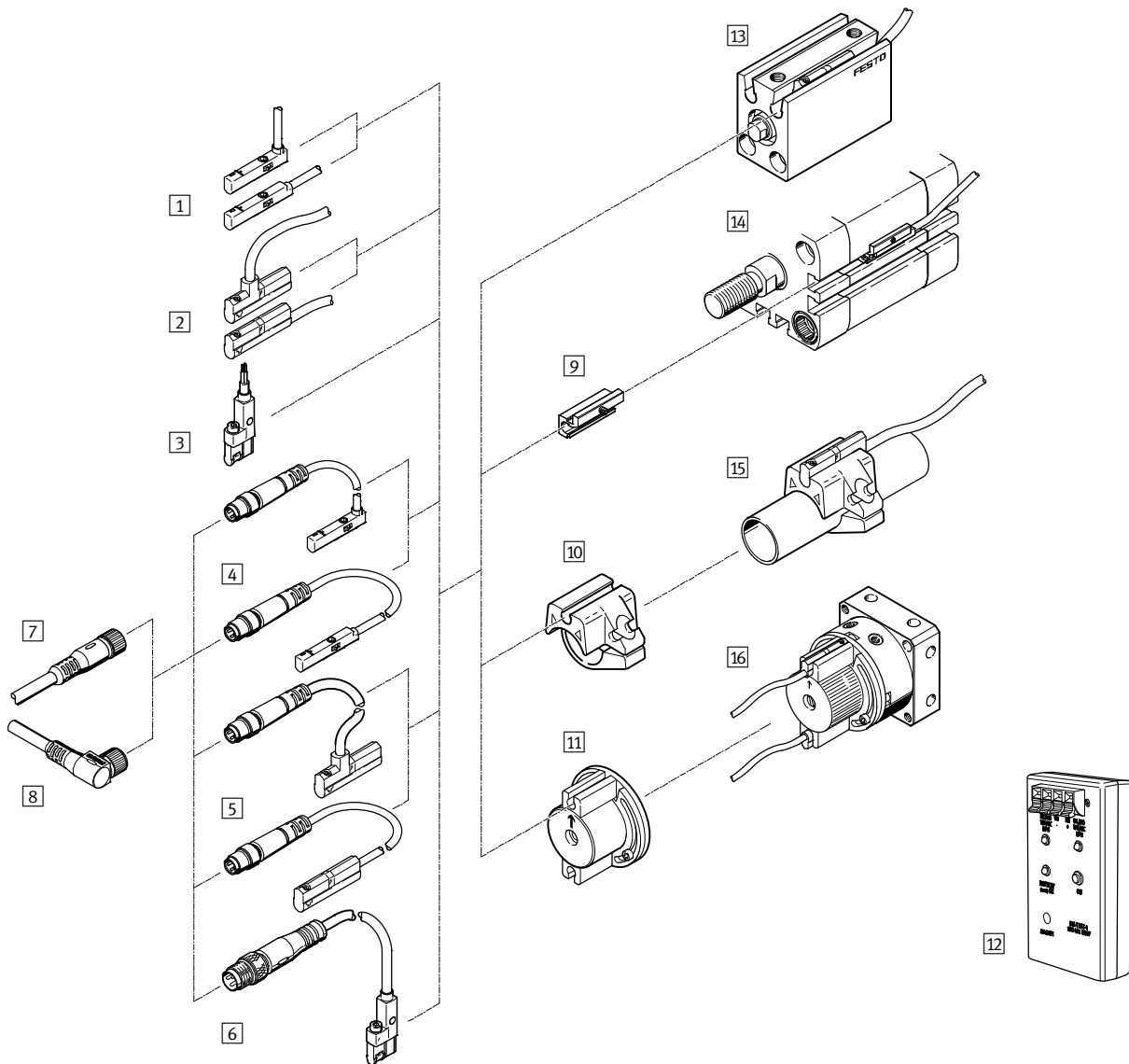

| Mounting attachments and accessories        | → Page/<br>Internet |
|---|---------------------|
| <b>Proximity sensors</b>                    |                     |
| 1 SMT/SME-10M-...-OE, with cable            | 6                   |
| 2 SME-10, with cable                        | 17                  |
| 3 SMT-10G-...-OE, with cable                | 22                  |
| 4 SMT/SME-10M-...-M..., with cable and plug | 6                   |
| 5 SME-10, with cable and plug               | 17                  |
| 6 SMT-10G-...-M..., with cable and plug     | 22                  |
| <b>Connecting cables</b>                    |                     |
| 7 Connecting cable NEBU-M...G...            | 25                  |
| 8 Connecting cable NEBU-M...W...            | 25                  |
| <b>Mounting kits</b>                        |                     |
| 9 Mounting kit SMBN-10                      | 24                  |
| 10 Mounting kit SMBR-10-...                 | 24                  |
| 11 Mounting kit WSM-...-SME-10              | 25                  |

| Mounting attachments and accessories | → Page/<br>Internet |
|--------------------------------------|---------------------|
| <b>Accessories</b>                   |                     |
| 12 Sensor tester SM-TEST-1           | 25                  |
| - Positioning component SMM-10       | 25                  |
| - Clip SMBK-10                       | 25                  |
| - Inscription label ASLR             | 25                  |
| - Safety clip NEAU                   | 25                  |
| <b>Drives</b>                        |                     |
| 13 Drives with C-slot                | -                   |
| 14 Drives with T-slot                | -                   |
| 15 Round cylinder                    | -                   |
| 16 Semi-rotary drive DSM             | -                   |

# Proximity sensors SMT/SME-10M, for C-slot

Type codes

## SMT/SME-10M

SMT - 10M - PS - 24V - E - 2,5 - L - - OE

### Function

|     |                                     |
|-----|-------------------------------------|
| SMT | Proximity sensor, magneto-resistive |
| SME | Proximity sensor, magnetic reed     |

### Design

|     |   |
|-----|---|
| 10M | For C-slot, insertable in slot from above |
|-----|---|

### Switching output, switching element function

|    |                          |
|----|--------------------------|
| PS | PNP, N/O contact, 3-wire |
| NS | NPN, N/O contact, 3-wire |
| ZS | N/O contact, 2-wire      |
| DS | N/O contact, 3-wire      |

### Rated operating voltage

|     |         |
|-----|---------|
| 24V | 24 V DC |
|-----|---------|

### Cable attribute

|   |                                   |
|---|-----------------------------------|
| E | Energy chain + robot applications |
|---|-----------------------------------|

### Cable length [m]

### Cable outlet

|   |         |
|---|---------|
| L | In-line |
| Q | Lateral |

### Cable designation

|   |                                  |
|---|----------------------------------|
| - | With inscription label holder    |
| N | Without inscription label holder |

### Connection technology

|     |   |
|-----|---|
| OE  | Open end                                |
| M8  | Cable with plug M8x1, snap-on flange    |
| M8D | Cable with plug M8x1, rotatable thread  |
| M12 | Cable with plug M12x1, rotatable thread |

# Proximity sensors SMT-10M, for C-slot

Technical data – Magneto-resistive



## Function

E.g. PNP, N/O contact, with cable

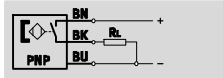

E.g. NPN, N/O contact, with cable

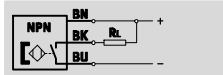

- Magneto-resistive measuring principle
- Insertable in slot from above, does not protrude over the cylinder profile
- Cable clip and holder for inscription labels included in the scope of delivery

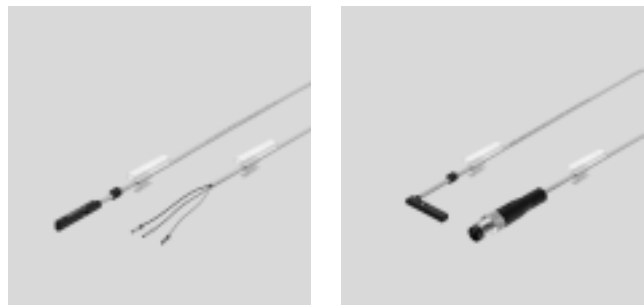

| General technical data                  |                                   |
|---|-----------------------------------|
| Design                                  | For C-slot                        |
| Conforms to                             | EN 60947-5-2                      |
| Certification                           | RCM trademark                     |
| CE mark (see declaration of conformity) | To EU EMC Directive <sup>1)</sup> |
| Special features                        | Oil-resistant                     |
| Note on materials                       | Cable free of halogen             |
|   | Free of copper and PTFE           |
|   | RoHS-compliant                    |

1) For information about the applicability of the component see the manufacturer's EC declaration of conformity at: [www.festo.com/sp](http://www.festo.com/sp) → User documentation.  
If the component is subject to restrictions on usage in residential, office or commercial environments or small businesses, further measures to reduce the emitted interference may be necessary.

| Input signal/measuring element |                   |    |              |
|--------------------------------|-------------------|----|--------------|
| Type SMT-10M                   | PS                | NS | ZS           |
| Measured variable              | Position          |    |              |
| Measuring principle            | Magneto-resistive |    |              |
| Ambient temperature [°C]       | -40 ... +70       |    |              |
| Fused switching field strength |                   |    |              |
| at -40 ... +70 °C [mT]         | 1.6 ... 3.0       |    | 1.95 ... 2.6 |
| at 25 °C [mT]                  | 1.8 ... 2.8       |    | 2.0 ... 2.5  |

| Switching output                                     |             |      |                        |
|--|-------------|------|------------------------|
| Type SMT-10M   | PS          | NS   | ZS                     |
| Switching output                                     | PNP         | NPN  | Non-contacting, 2-wire |
| Switching element function                           | N/O contact |      |                        |
| Repetition accuracy of switching output in ± mm      | 0.1         |      |                        |
| Switch-on time [ms]                                  | ≤1.3        | ≤1.3 | ≤1.0                   |
| Switch-off time [ms]                                 | ≤1.4        | ≤1.4 | ≤1.0                   |
| Max. switching frequency [Hz]                        | 150         |      |                        |
| Max. output current [mA]                             | 100         |      |                        |
| Max. output current in mounting kits [mA]            | 50          |      |                        |
| Max. switching capacity DC [W]                       | 2.8         | 2.8  | 2.4                    |
| Max. switching capacity DC in mounting kits [W]      | 1.5         |      | 1.2                    |
| Voltage drop [V]                                     | ≤1.7        | ≤1.5 | ≤6                     |
| Devices can be switched in parallel                  | 5           | 3    | 5                      |
| Minimum load current [mA]                            | 0           |      | 2.4                    |
| Residual current (at room temperature when new) [µA] | <50         | <150 | <1.5                   |

# Proximity sensors SMT-10M, for C-slot

FESTO

Technical data – Magneto-resistive

| Output, additional data          |     |
|----------------------------------|-----|
| Protection against short circuit | Yes |
| Protection against overloading   | Yes |

| Electronic components       |                                |           |
|-----------------------------|--------------------------------|-----------|
| Rated operating voltage     | [V DC]                         | 24        |
| Operating voltage range     | [V DC]                         | 10 ... 30 |
| Reverse polarity protection | For all electrical connections |           |

| Electromechanical components |  |                          |                        |                           |               |                          |                        |                           |
|------------------------------|--|--------------------------|------------------------|---------------------------|---------------|--------------------------|------------------------|---------------------------|
| Type SMT-10M                 | PS/NS  |                          |                        |                           | ZS            |                          |                        |                           |
| Electrical connection        | OE   | M8D                      | M8                     | M12                       | OE            | M8D                      | M8                     | M12                       |
| Electrical connection        | Cable, 3-wire  | Cable with plug, 3-pin   |                        |                           | Cable, 2-wire | Cable with plug, 2-pin   |                        |                           |
|                              |  | M8x1<br>Rotatable thread | M8x1<br>Snap-on flange | M12x1<br>Rotatable thread |               | M8x1<br>Rotatable thread | M8x1<br>Snap-on flange | M12x1<br>Rotatable thread |
| Connection direction         | In-line<br>Lateral   |                          |                        |                           |               |                          |                        |                           |
| Cable test conditions        | Energy chain: 5 million cycles, bending radius 28 mm<br>Torsional strength: >300,000 cycles, ±270°/0.1 m<br>Resistance to bending: to Festo standard; test conditions on request |                          |                        |                           |               |                          |                        |                           |
| Cable length                 | [m]  | 0.2 ... 30               |                        |                           |               |                          |                        |                           |
| Cable attribute              | Energy chain + robot applications  |                          |                        |                           |               |                          |                        |                           |
| Cable sheath materials       | TPE-U(PUR)   |                          |                        |                           |               |                          |                        |                           |

| Mechanical components  |  |
|------------------------|--|
| Type of mounting       | Screw-clamped in slot, insertable from above |
| Max. tightening torque | [Nm] 0.4                                     |
| Mounting position      | Any  |
| Housing                | PA reinforced<br>High-alloy stainless steel  |

| Display/operation        |            |
|--------------------------|------------|
| Switching status display | Yellow LED |

| Immissions/emissions                                 |                  |
|--|------------------|
| Ambient temperature with flexible cable installation | [°C] -20 ... +70 |
| Protection class                                     | IP65<br>IP68     |

# Proximity sensors SMT-10M, for C-slot

Technical data – Magneto-resistive



| Pin allocation to EN 60947-5-2 |     |             |            | Pin allocation to EN 60947-5-2 |     |             |            |
|--------------------------------|-----|-------------|------------|--------------------------------|-----|-------------|------------|
| M8x1, 2-pin                    |     |             |            | M8x1, 3-pin                    |     |             |            |
| N/O contact                    |     |             |            | N/O contact                    |     |             |            |
|                                | Pin | Wire colour | Allocation |                                | Pin | Wire colour | Allocation |
|                                | 1   | Brown       | +          |                                | 1   | Brown       | +          |
|                                | 4   | Black       | Output     |                                | 3   | Blue        | -          |
|                                |     |             |            |                                | 4   | Black       | Output     |

| Pin allocation to EN 60947-5-2 |     |             |            | Pin allocation to EN 60947-5-2 |     |             |            |
|--------------------------------|-----|-------------|------------|--------------------------------|-----|-------------|------------|
| M12x1, 2-pin                   |     |             |            | M12x1, 3-pin                   |     |             |            |
| N/O contact                    |     |             |            | N/O contact                    |     |             |            |
|                                | Pin | Wire colour | Allocation |                                | Pin | Wire colour | Allocation |
|                                | 1   | Brown       | +          |                                | 1   | Brown       | +          |
|                                | 4   | Black       | Output     |                                | 3   | Blue        | -          |
|                                |     |             |            |                                | 4   | Black       | Output     |

## Dimensions Download CAD data → [www.festo.com](http://www.festo.com)

SMT-10M-...-L, in-line connection

1 Yellow LED                      5 Cable with open end                      7 Plug M8x1, rotatable thread                      L1 Cable length  
2 SMT-10M                              6 Plug M8x1, snap-on flange                      8 Plug M12x1

| Type            | B1  | D1   | D2    | D3  | H1  | L2   | L3   | L4   | L5 | L6 | L7 | ⌀   |
|-----------------|-----|------|-------|-----|-----|------|------|------|----|----|----|-----|
| SMT-10M-...-OE  | 2.9 | 2.15 | -     | -   | 4.6 | 50   | 22.9 | 20.9 | 23 | 50 | 7  | 1.5 |
| SMT-10M-...-M8D |     |      | M8x1  | 8.5 |     | 32.7 |      |      |    |    | -  |     |
| SMT-10M-...-M8  |     |      | M8x1  | 9.6 |     | 41.1 |      |      |    |    | -  |     |
| SMT-10M-...-M12 |     |      | M12x1 | 15  |     | 55.5 |      |      |    |    | -  |     |



# Proximity sensors SMT-10M, for C-slot

Technical data – Magneto-resistive

## Dimensions

Download CAD data → [www.festo.com](http://www.festo.com)

SMT-10M-...-Q, lateral connection

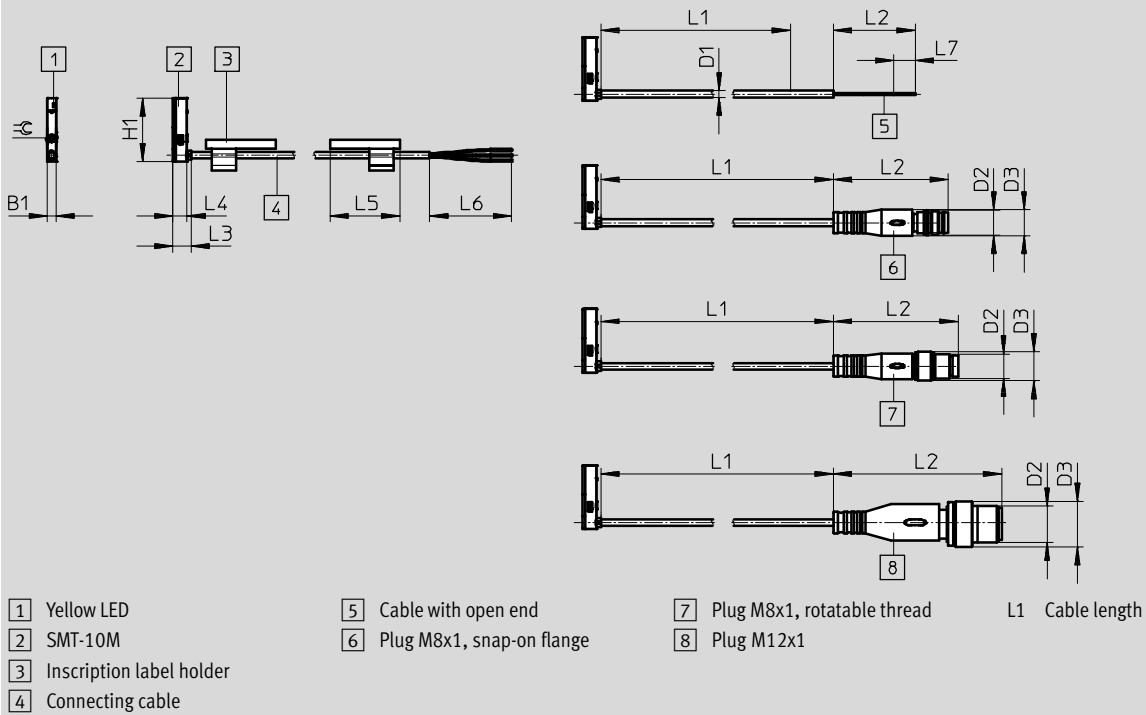

| Type            | B1  | D1   | D2    | D3  | H1   | L2   | L3 | L4  | L5 | L6 | L7 | ≅   |
|-----------------|-----|------|-------|-----|------|------|----|-----|----|----|----|-----|
| SMT-10M-...-OE  | 2.9 | 2.15 | -     | -   | 20.9 | 50   | 6  | 4.6 | 23 | 50 | 7  | 1.5 |
| SMT-10M-...-M8D |     |      | M8x1  | 8.5 |      | 32.7 |    |     |    |    | -  |     |
| SMT-10M-...-M8  |     |      | M8x1  | 9.6 |      | 41.1 |    |     |    |    | -  |     |
| SMT-10M-...-M12 |     |      | M12x1 | 15  |      | 55.5 |    |     |    |    | -  |     |

## Ordering data

|   | Switching output       | Electrical connection |                                   | Cable length [m] | Weight [g] | Part No.                  | Type                       |
|---|------------------------|-----------------------|-----------------------------------|------------------|------------|---------------------------|----------------------------|
|   |                        | Cable                 | Cable with plug, rotatable thread |                  |            |                           |                            |
|   | N/O contact            |                       |                                   |                  |            |                           |                            |
|   | PNP                    | 3-wire                | -                                 | 2.5              | 16.8       | 551373                    | SMT-10M-PS-24V-E-2,5-L-OE  |
|   |                        |                       | -                                 | 0.3              | 6.7        | 551374                    | SMT-10M-PS-24V-E-2,5-Q-OE  |
|   |                        | -                     | M8x1, 3-pin                       | 0.3              | 6.7        | 551375                    | SMT-10M-PS-24V-E-0,3-L-M8D |
|   | NPN                    | 3-wire                | -                                 | 2.5              | 16.8       | 551377                    | SMT-10M-NS-24V-E-2,5-L-OE  |
|   |                        |                       | -                                 | 0.3              | 6.7        | 551378                    | SMT-10M-NS-24V-E-2,5-Q-OE  |
|   |                        | -                     | M8x1, 3-pin                       | 0.3              | 6.7        | 551379                    | SMT-10M-NS-24V-E-0,3-L-M8D |
|   | Non-contacting, 2-wire | 2-wire                | -                                 | 2.5              | 14.6       | 551380                    | SMT-10M-NS-24V-E-0,3-Q-M8D |
| - |                        |                       | 2.5                               | 14.6             | 551382     | SMT-10M-ZS-24V-E-2,5-L-OE |                            |
|   |                        |                       |                                   |                  |            | 551383                    | SMT-10M-ZS-24V-E-2,5-Q-OE  |

# Proximity sensors SMT-10M, for C-slot

Modular product system – Magneto-resistive

| M Mandatory data        |          |                  |                         |                 |                   | O Options    | M                 |                        |
|-------------------------|----------|------------------|-------------------------|-----------------|-------------------|--------------|-------------------|------------------------|
| Module No.              | Function | Switching output | Rated operating voltage | Cable attribute | Cable length in m | Cable outlet | Cable designation | Connection technology  |
| 551372                  | SMT-10M  | PS<br>NS<br>ZS   | 24V                     | E               | 0.2 ... 30        | L<br>Q       | N                 | OE<br>M8D<br>M8<br>M12 |
| <b>Ordering example</b> |          |                  |                         |                 |                   |              |                   |                        |
| 551372                  | SMT-10M  | NS               | 24V                     | E               | 3                 | L            | N                 | M8D                    |

| Ordering table |                                |   |         |            |
|----------------|--------------------------------|---|---------|------------|
| Size           |                                | Condi-tions   | Code    | Enter code |
| M              | Module No.                     | 551372  |         |            |
|                | Function                       | Proximity sensor for C-slot, non-contacting   | SMT-10M | SMT-10M    |
|                | Switching output               | 3-wire PNP N/O contact  | PS      |            |
|                |                                | 3-wire NPN N/O contact  | NS      |            |
|                |                                | 2-wire N/O contact  | ZS      |            |
|                | Rated operating voltage [V DC] | 24  | 24V     | 24V        |
|                | Cable attribute                | Energy chain + robot applications   | E       | E          |
|                | Cable length [m]               | 0.2 ... 30<br>(0.2 ... 5.0 m in 0.1 m increments, 5.0 ... 30 m in 0.5 m increments) | ...     |            |
|                | Cable outlet                   | In-line   | L       |            |
|                |                                | Lateral   | Q       |            |
| O              | Cable designation              | With inscription label holder   |         |            |
|                |                                | Without inscription label holder  | N       |            |
| M              | Connection technology          | Open end  | OE      |            |
|                |                                | M8, rotatable thread  | M8D     |            |
|                |                                | M8, snap-on flange  | M8      |            |
|                |                                | M12, rotatable thread   | M12     |            |

Transfer order code

|        |         |   |  |   |     |   |   |   |  |   |  |   |  |   |  |
|--------|---------|---|--|---|-----|---|---|---|--|---|--|---|--|---|--|
| 551372 | SMT-10M | - |  | - | 24V | - | E | - |  | - |  | - |  | - |  |
|--------|---------|---|--|---|-----|---|---|---|--|---|--|---|--|---|--|

# Proximity sensors SME-10M, for C-slot

Technical data – Magnetic reed

**Function**

E.g. N/O contact, 3-wire, with cable

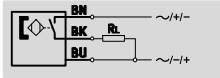

E.g. N/O contact, 3-wire, with plug

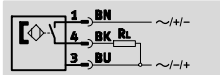

- Magnetic reed measuring principle
- Insertable in slot from above, does not protrude over the cylinder profile
- Cable clip and holder for inscription labels included in the scope of delivery

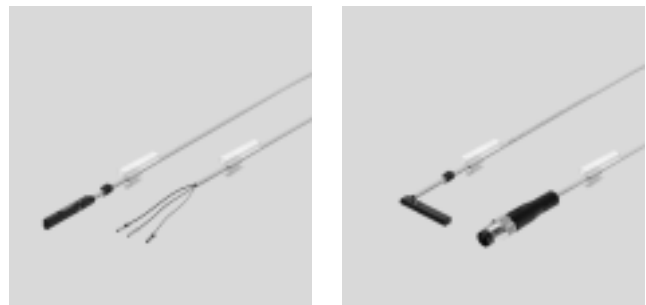

| General technical data                  |                                   |
|---|-----------------------------------|
| Design                                  | For C-slot                        |
| Conforms to                             | EN 60947-5-2                      |
| Certification                           | RCM trademark                     |
| Special features                        | Oil resistant                     |
| CE mark (see declaration of conformity) | To EU EMC Directive <sup>1)</sup> |
| Note on materials                       | Cable free of halogen             |
|   | Free of copper and PTFE           |
|   | RoHS-compliant                    |

1) For information about the applicability of the component see the manufacturer's EC declaration of conformity at: [www.festo.com/sp](http://www.festo.com/sp) → User documentation.  
If the component is subject to restrictions on usage in residential, office or commercial environments or small businesses, further measures to reduce the emitted interference may be necessary.

| Input signal/measuring element |                  |
|--------------------------------|------------------|
| Measured variable              | Position         |
| Measuring principle            | Magnetic reed    |
| Ambient temperature            | [°C] -40 ... +70 |

| Switching output                                |      |                     |           |
|---|------|---------------------|-----------|
| Type SME-10M                                    |      | DS                  | ZS        |
| Switching output                                |      | Contacting, bipolar |           |
| Switching element function                      |      | N/O contact         |           |
| Repetition accuracy of switching output in ± mm | [mm] | 0.1                 |           |
| Switch-on time                                  | [ms] | 0 ... 1.2           |           |
| Switch-off time                                 | [ms] | 0 ... 1             |           |
| Max. switching frequency                        | [Hz] | 50                  |           |
| Max. output current                             | [mA] | 300                 | 100       |
| Max. output current in mounting kits            | [mA] | 50                  | 50        |
| Max. switching capacity AC                      | [VA] | 9                   | 3         |
| Max. switching capacity AC in mounting kits     | [VA] | 1.5                 | 1.5       |
| Max. switching capacity DC                      | [W]  | 9                   | 3         |
| Max. switching capacity DC in mounting kits     | [W]  | 1.5                 | 1.5       |
| Voltage drop                                    | [V]  | 0 ... 0.5           | 0 ... 4.5 |

| Output, additional data          |    |
|----------------------------------|----|
| Protection against short circuit | No |
| Protection against overloading   | No |

# Proximity sensors SME-10M, for C-slot

Technical data – Magnetic reed



| Electronic components       |        |          |
|-----------------------------|--------|----------|
| Rated operating voltage     | [V DC] | 24       |
| Operating voltage range AC  | [V]    | 5 ... 30 |
| Operating voltage range DC  | [V]    | 5 ... 30 |
| Reverse polarity protection |        | No       |

| Electromechanical components |  |                          |                        |                           |               |                          |                        |                           |
|------------------------------|--|--------------------------|------------------------|---------------------------|---------------|--------------------------|------------------------|---------------------------|
| Type SME-10M                 | DS   |                          |                        |                           | ZS            |                          |                        |                           |
| Electrical connection        | OE   | M8D                      | M8                     | M12                       | OE            | M8D                      | M8                     | M12                       |
| Electrical connection        | Cable, 3-wire  | Cable with plug, 3-pin   |                        |                           | Cable, 2-wire | Cable with plug, 2-pin   |                        |                           |
|                              |  | M8x1<br>Rotatable thread | M8x1<br>Snap-on flange | M12x1<br>Rotatable thread |               | M8x1<br>Rotatable thread | M8x1<br>Snap-on flange | M12x1<br>Rotatable thread |
| Connection direction         | In-line<br>Lateral   |                          |                        |                           |               |                          |                        |                           |
| Cable test conditions        | Energy chain: 5 million cycles, bending radius 28 mm                 |                          |                        |                           |               |                          |                        |                           |
|                              | Torsional strength: >300,000 cycles, ±270°/0.1 m                     |                          |                        |                           |               |                          |                        |                           |
|                              | Resistance to bending: to Festo standard; test conditions on request |                          |                        |                           |               |                          |                        |                           |
| Cable length                 | [m]  | 0.2 ... 10               |                        |                           |               |                          |                        |                           |
| Cable attribute              | Energy chain + robot applications                                    |                          |                        |                           |               |                          |                        |                           |
| Cable sheath materials       | TPE-U(PUR)   |                          |                        |                           |               |                          |                        |                           |

| Mechanical components  |  |
|------------------------|--|
| Type of mounting       | Screw-clamped in slot, insertable from above |
| Max. tightening torque | 0.4  |
| Mounting position      | Any  |
| Housing                | PA reinforced                                |
|                        | High-alloy stainless steel                   |

| Display/operation        |            |
|--------------------------|------------|
| Switching status display | Yellow LED |

| Immissions/emissions                                 |                  |
|--|------------------|
| Ambient temperature with flexible cable installation | [°C] –20 ... +70 |
| Protection class                                     | IP65             |
|  | IP68             |

| Pin allocation to EN 60947-5-2 |     |             |            |
|--------------------------------|-----|-------------|------------|
| M8x1, 2-pin                    |     |             |            |
| N/O contact                    |     |             |            |
|                                | Pin | Wire colour | Allocation |
|                                | 1   | Brown       | +          |
|                                | 4   | Black       | Output     |

| Pin allocation to EN 60947-5-2 |     |             |            |
|--------------------------------|-----|-------------|------------|
| M8x1, 3-pin                    |     |             |            |
| N/O contact                    |     |             |            |
|                                | Pin | Wire colour | Allocation |
|                                | 1   | Brown       | +          |
|                                | 3   | Blue        | -          |
|                                | 4   | Black       | Output     |

| Pin allocation to EN 60947-5-2 |     |             |            |
|--------------------------------|-----|-------------|------------|
| M12x1, 2-pin                   |     |             |            |
| N/O contact                    |     |             |            |
|                                | Pin | Wire colour | Allocation |
|                                | 1   | Brown       | +          |
|                                | 4   | Black       | Output     |

| Pin allocation to EN 60947-5-2 |     |             |            |
|--------------------------------|-----|-------------|------------|
| M12x1, 3-pin                   |     |             |            |
| N/O contact                    |     |             |            |
|                                | Pin | Wire colour | Allocation |
|                                | 1   | Brown       | +          |
|                                | 3   | Blue        | -          |
|                                | 4   | Black       | Output     |

# Proximity sensors SME-10M, for C-slot

Technical data – Magnetic reed

## Dimensions

Download CAD data → [www.festo.com](http://www.festo.com)

SME-10M-...-L, in-line connection

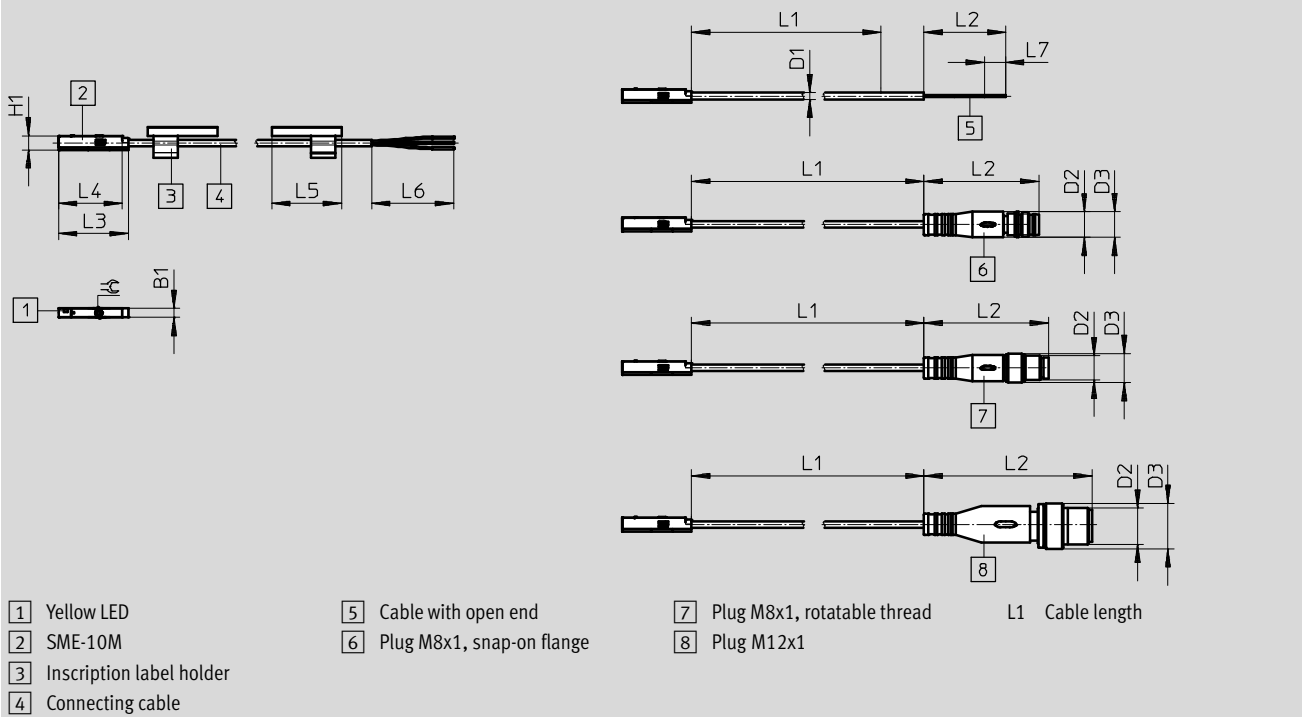

| Type            | B1 | D1   | D2    | D3  | H1  | L2   | L3   | L4   | L5 | L6 | L7 | ≅   |
|-----------------|----|------|-------|-----|-----|------|------|------|----|----|----|-----|
| SME-10M-...-OE  | 3  | 2.15 | -     | -   | 4.6 | 50   | 26.6 | 24.6 | 23 | 50 | 7  | 1.5 |
| SME-10M-...-M8D |    |      | M8x1  | 8.5 |     | 32.7 |      |      |    |    | -  |     |
| SME-10M-...-M8  |    |      | M8x1  | 9.6 |     | 41.1 |      |      |    |    | -  |     |
| SME-10M-...-M12 |    |      | M12x1 | 15  |     | 55.5 |      |      |    |    | -  |     |

# Proximity sensors SME-10M, for C-slot

Technical data – Magnetic reed



## Dimensions

Download CAD data → [www.festo.com](http://www.festo.com)

SME-10M-...-Q, lateral connection

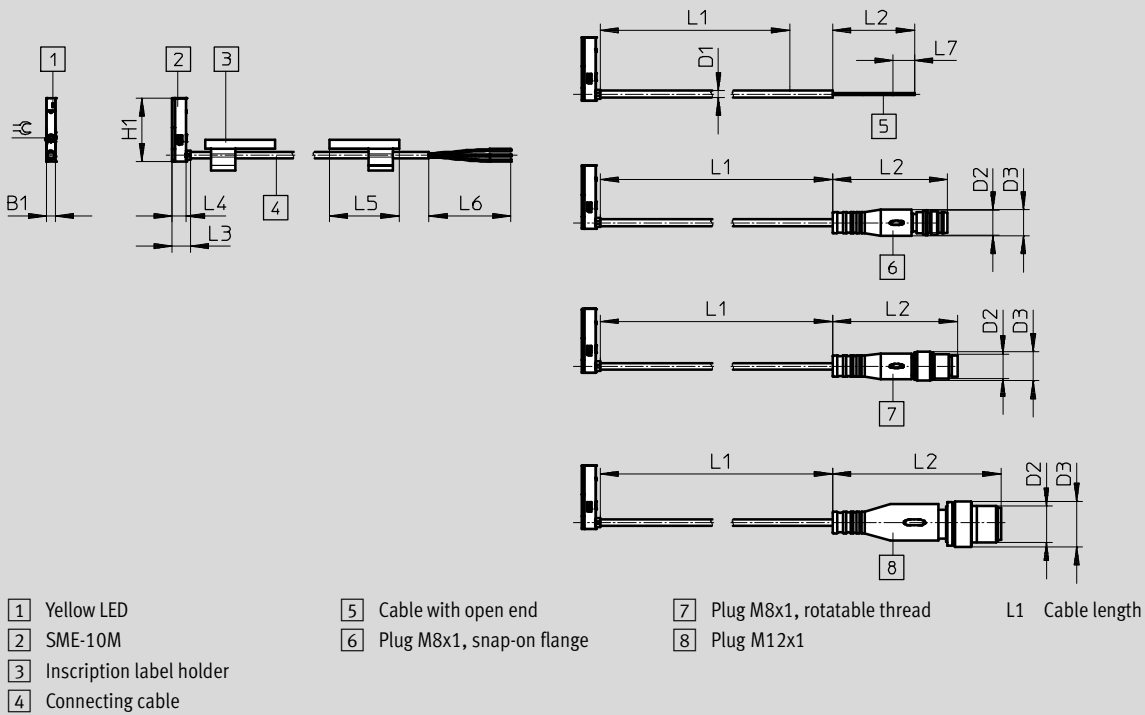

| Type            | B1 | D1   | D2    | D3  | H1   | L2   | L3 | L4  | L5 | L6 | L7 | ⊕   |
|-----------------|----|------|-------|-----|------|------|----|-----|----|----|----|-----|
| SME-10M-...-OE  | 3  | 2.15 | -     | -   | 24.6 | 50   | 6  | 4.6 | 23 | 50 | 7  | 1.5 |
| SME-10M-...-M8D |    |      | M8x1  | 8.5 |      | 32.7 |    |     |    |    | -  |     |
| SME-10M-...-M8  |    |      | M8x1  | 9.6 |      | 41.1 |    |     |    |    | -  |     |
| SME-10M-...-M12 |    |      | M12x1 | 15  |      | 55.5 |    |     |    |    | -  |     |

## Ordering data

|  | Switching output    | Electrical connection |                                   | Cable length [m] | Weight [g] | Part No. | Type                      |                            |
|--|---------------------|-----------------------|-----------------------------------|------------------|------------|----------|---------------------------|----------------------------|
|  |                     | Cable                 | Cable with plug, rotatable thread |                  |            |          |                           |                            |
|  | N/O contact         |                       |                                   |                  |            |          |                           |                            |
|  | Contacting, bipolar | 3-wire                | -                                 | -                | 2.5        | 16.8     | 551365                    | SME-10M-DS-24V-E-2,5-L-OE  |
|  |                     |                       | -                                 | M8x1, 3-pin      | 0.3        | 6.7      | 551366                    | SME-10M-DS-24V-E-2,5-Q-OE  |
|  |                     | 2-wire                | -                                 | -                | 2.5        | 14.6     | 551367                    | SME-10M-DS-24V-E-0,3-L-M8D |
|  |                     |                       | -                                 | -                | -          | 2.5      | 14.6                      | 551368                     |
|  |                     |                       |                                   |                  |            | 551369   | SME-10M-ZS-24V-E-2,5-L-OE |                            |
|  |                     |                       |                                   |                  |            | 551370   | SME-10M-ZS-24V-E-2,5-Q-OE |                            |



# Proximity sensors SME-10, for C-slot

Type codes

| SME-10   |   |
|--|---|
| SME – 10 – KL – LED – 24   |   |
| <b>Function</b>  |   |
| SME  | Proximity sensor, magnetic reed           |
| <b>Design</b>  |   |
| 10   | For C-slot, insertable in slot lengthwise |
| <b>Electrical connection, cable length, connection direction</b> |   |
| KL   | Cable, 2.5 m, in-line                     |
| KQ   | Cable, 2.5 m, lateral                     |
| SL   | Plug M8x1 with cable, 0.3 m, in-line      |
| SQ   | Plug M8x1 with cable, 0.3 m, lateral      |
| <b>Switching status display</b>                                  |   |
| LED  | Yellow LED                                |
| <b>Rated operating voltage</b>                                   |   |
| 24   | 24 V DC                                   |



# Proximity sensors SME-10, for C-slot

Technical data – Magnetic reed

**Function**

NO contact, 3-wire, with cable

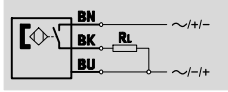

N/O contact, 3-wire, with plug

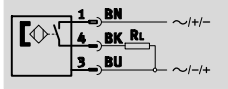

- Magneto-resistive measuring principle
- Insertable in the slot lengthwise

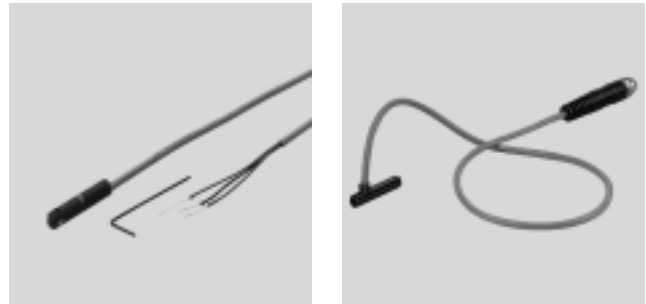

| General technical data                  |                         |
|---|-------------------------|
| Design                                  | For C-slot              |
| Based on standard                       | EN 60947-5-2            |
| CE mark (see declaration of conformity) | To EU EMC Directive     |
| Note on materials                       | Free of copper and PTFE |

| Input signal/measuring element |               |
|--------------------------------|---------------|
| Measuring principle            | Magnetic reed |
| Ambient temperature [°C]       | -20 ... +70   |

| Switching output                        |                     |
|---|---------------------|
| Switching output                        | Contacting, bipolar |
| Switching element function              | N/O contact         |
| Reproducibility of switching value [mm] | ±0.1                |
| Switch-on time [ms]                     | ≤0.6                |
| Switch-off time [ms]                    | ≤0.05               |
| Max. output current [mA]                | 100                 |
| Max. switching frequency [Hz]           | 500                 |
| Max. switching capacity DC [W]          | 1                   |
| Voltage drop [V]                        | 0                   |

| Output, additional data          |    |
|----------------------------------|----|
| Protection against short circuit | No |
| Protection against overloading   | No |

| Electronic components          |           |
|--------------------------------|-----------|
| Operating voltage range DC [V] | 12 ... 27 |
| Operating voltage range AC [V] | 12 ... 27 |
| Reverse polarity protection    | No        |

| Electromechanical components          |                     |                                |
|---------------------------------------|---------------------|--------------------------------|
| Type                                  | SME-10-...-K...-... | SME-10-...-S...-...            |
| Electrical connection                 | Cable, 3-wire       | Cable with plug<br>M8x1, 3-pin |
| Connection direction                  | In-line, lateral    | In-line, lateral               |
| Cable length [m]                      | 2.5                 | 0.3                            |
| Information on cable sheath materials | TPE-U (PUR)         |                                |

# Proximity sensors SME-10, for C-slot

Technical data – Magnetic reed

| Mechanical components            |  |  |
|----------------------------------|--|--|
| Type                             | SME-10-...-K...-...                                  | SME-10-...-S...-...  |
| Type of mounting                 | Clamped in C-slot, insertable in the slot lengthwise |  |
| Tightening torque                | [Nm]   | 0.18   |
| Information on housing materials | PPS,<br>high-alloy stainless steel                   | PPS,<br>TPE-U(PU),<br>high-alloy stainless steel,<br>nickel-plated brass |

| Display/operation        |            |
|--------------------------|------------|
| Switching status display | Yellow LED |

| Immissions/emissions                                 |      |              |
|--|------|--------------|
| Ambient temperature with flexible cable installation | [°C] | -5 ... +70   |
| Protection class                                     |      | IP65<br>IP67 |
| Insulation voltage                                   | [V]  | 50           |
| Surge capacity                                       | [kV] | 0.8          |
| Degree of contamination                              |      | 3            |

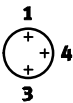
| Pin allocation to EN 60947-5-2  |     |             |            |
|---|-----|-------------|------------|
| Plug, 3-pin   |     |             |            |
| M8x1  | Pin | Wire colour | Allocation |
|  | 1   | Brown       | +          |
|   | 3   | Blue        | -          |
|   | 4   | Black       | Output     |
|   |     |             |            |

# Proximity sensors SME-10, for C-slot

Technical data – Magnetic reed

## Dimensions

Download CAD data → [www.festo.com](http://www.festo.com)

Cable, in-line connection

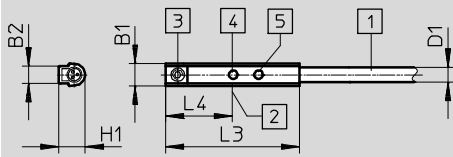

- 1 Connecting cable
- 2 Theoretical switching point
- 3 Threaded pin M2x4
- 4 Yellow LED (positive switching)
- 5 Yellow LED (negative switching)

| Type             | B1  | B2  | D1       | H1  | L3         | L4 |
|------------------|-----|-----|----------|-----|------------|----|
| SME-10-KL-LED-24 | 3.7 | 2.9 | 2.4<br>∅ | 4.3 | +0.4<br>22 | 11 |

## Dimensions

Download CAD data → [www.festo.com](http://www.festo.com)

Cable, lateral connection

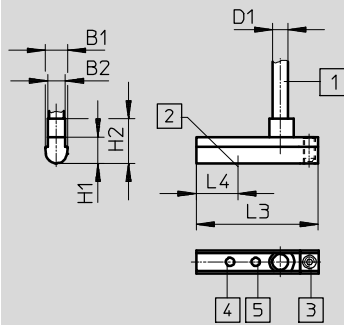

- 1 Plug to fit connecting cable NEBU-M8
- 2 Theoretical switching point
- 3 Threaded pin M2x4
- 4 Yellow LED (positive switching)
- 5 Yellow LED (negative switching)

| Type             | B1  | B2  | D1       | H1  | H2  | L3         | L4  |
|------------------|-----|-----|----------|-----|-----|------------|-----|
| SME-10-KQ-LED-24 | 3.7 | 2.9 | 2.4<br>∅ | 4.3 | 7.3 | +0.4<br>20 | 6.8 |

# Proximity sensors SME-10, for C-slot

Technical data – Magnetic reed



## Dimensions Download CAD data → [www.festo.com](http://www.festo.com)

Cable, in-line connection

- 1 Plug to fit connecting cable NEBU-M8
- 2 Theoretical switching point
- 3 Threaded pin M2x4
- 4 Yellow LED (positive switching)
- 5 Yellow LED (negative switching)

| Type             | B1  | B2  | D1  | D2 | H1  | L1  | L2 | L3   | L4 |
|------------------|-----|-----|-----|----|-----|-----|----|------|----|
| SME-10-SL-LED-24 | 3.7 | 2.9 | 2.4 | M8 | 4.3 | 310 | ±1 | +0.4 | 11 |

## Dimensions Download CAD data → [www.festo.com](http://www.festo.com)

Plug M8x1, lateral connection

- 1 Plug to fit connecting cable NEBU-M8
- 2 Theoretical switching point
- 3 Threaded pin M2x4
- 4 Yellow LED (positive switching)
- 5 Yellow LED (negative switching)

| Type             | B1  | B2  | D2 | H1  | H2  | L1         | L2 | L3   | L4  |
|------------------|-----|-----|----|-----|-----|------------|----|------|-----|
| SME-10-SQ-LED-24 | 3.7 | 2.9 | M8 | 4.3 | 7.3 | -10 ... 30 | ±1 | +0.4 | 6.8 |

## Ordering data

|                           | Switching output    | Electrical connection |                       | Cable length [m] | Part No.                | Type                    |
|---------------------------|---------------------|-----------------------|-----------------------|------------------|-------------------------|-------------------------|
|                           |                     | Cable                 | Cable with plug, M8x1 |                  |                         |                         |
| <b>In-line connection</b> |                     |                       |                       |                  |                         |                         |
|                           | N/O contact         |                       |                       |                  |                         |                         |
|                           | Contacting, bipolar | 3-wire                | –                     | 2.5              | <b>173210</b>           | <b>SME-10-KL-LED-24</b> |
| –                         |                     | 3-pin                 | 0.3                   | <b>173212</b>    | <b>SME-10-SL-LED-24</b> |                         |
| <b>Lateral connection</b> |                     |                       |                       |                  |                         |                         |
|                           | N/O contact         |                       |                       |                  |                         |                         |
|                           | Contacting, bipolar | 3-wire                | –                     | 2.5              | <b>173211</b>           | <b>SME-10-KQ-LED-24</b> |
|                           |                     | –                     | 3-pin                 | 0.3              | <b>173213</b>           | <b>SME-10-SQ-LED-24</b> |

# Proximity sensors SMT-10G, for C-slot

Type codes

## SMT-10G

SMT - 10G - PS - 24V - E - 2,5Q - OE

| Function |                                     |
|----------|-------------------------------------|
| SMT      | Proximity sensor, magneto-resistive |

| Design |   |
|--------|---|
| 10G    | For C-slot, insertable in slot lengthwise |

| Switching output, switching element function |                          |
|--|--------------------------|
| PS   | PNP, N/O contact, 3-wire |

| Rated operating voltage |         |
|-------------------------|---------|
| 24V                     | 24 V DC |

| Cable properties |                                   |
|------------------|-----------------------------------|
| E                | Energy chain + robot applications |

| Cable length [m], connection direction |   |
|--|---|
| 2,5Q                                   | Cable, 2.5 m, lateral <sup>1)</sup>           |
| 0,3Q                                   | Cable with plug, 0.3 m, lateral <sup>2)</sup> |

| Electrical connection |  |
|-----------------------|--|
| OE                    | Open end                               |
| M8D                   | Cable with plug M8x1, rotatable thread |

1) Only with electrical connection OE  
 2) Not with electrical connection OE

# Proximity sensors SMT-10G, for C-slot

Technical data – Magneto-resistive

**Function**

PNP, N/O contact, with cable, 3-wire

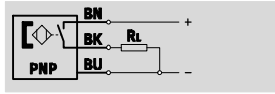

- Magneto-resistive measuring principle
- Insertable in slot lengthwise
- Design ideally matched to gripper sensing

PNP, N/O contact, with plug

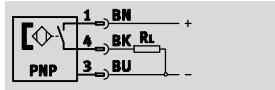

| General technical data                  |   |
|---|---|
| Design                                  | For C-slot                                |
| Based on standard                       | EN 60947-5-2                              |
| Certification                           | c UL us - Listed (OL)                     |
| CE mark (see declaration of conformity) | To EU EMC Directive                       |
| Note on materials                       | Free of copper and PTFE<br>RoHS-compliant |

| Input signal/measuring element |                   |
|--------------------------------|-------------------|
| Measuring principle            | Magneto-resistive |
| Ambient temperature            | [°C] -20 ... +70  |

| Switching output           |             |
|----------------------------|-------------|
| Switching output           | PNP         |
| Switching element function | N/O contact |
| Max. output current        | [mA] 80     |
| Max. switching capacity DC | [W] 2.4     |

| Output, additional data          |        |
|----------------------------------|--------|
| Protection against short circuit | Pulsed |
| Protection against overloading   | Yes    |

| Electronic components       |                                |
|-----------------------------|--------------------------------|
| Operating voltage range     | [V DC] 10 ... 30               |
| Reverse polarity protection | For all electrical connections |

| Electromechanical components |  |   |
|------------------------------|--|---|
| Type                         | SMT-10G-...-OE   | SMT-10G-...-M8D                               |
| Electrical connection        | Cable, 3-wire  | Cable with plug M8x1, 3-pin, rotatable thread |
| Connection direction         | Lateral  |   |
| Cable test conditions        | Energy chain: 5 million cycles, bending radius 28 mm                 |   |
|                              | Torsional strength: > 300,000 cycles, ±270°/0.1 m                    |   |
|                              | Resistance to bending: to Festo standard; test conditions on request |   |
| Cable length                 | [m] 2.5  | 0.3   |
| Cable properties             | Energy chain + robot applications                                    |   |
| Cable sheath material        | Thermoplastic polyurethane elastomer                                 |   |

| Mechanical components |  |
|-----------------------|--|
| Type of mounting      | Clamped in C-slot<br>Insertable in slot lengthwise |
| Housing material      | Reinforced polyamide                               |



# Proximity sensors SMT/SME-10, for C-slot

Accessories



## Mounting SMBN-10

for mounting proximity sensors  
SME/SMT-10 on drives with T-slot

Materials:

Rail: Anodised wrought aluminium alloy

Screws: High-alloy stainless steel

Note on materials:

Free of copper and PTFE

RoHS-compliant

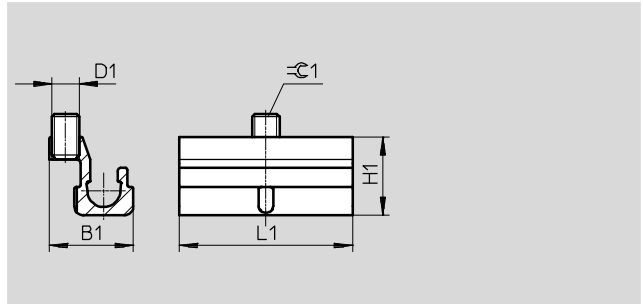

| Dimensions and ordering data |    |     |     |    |                 |          |         |
|------------------------------|----|-----|-----|----|-----------------|----------|---------|
| For piston $\varnothing$     | D1 | B1  | H1  | L1 | $\varnothing$ 1 | Part No. | Type    |
| 125 ... 320                  | M3 | 9.3 | 8.6 | 19 | 1.5             | 537809   | SMBN-10 |

## Mounting kit SMBR

Material:

Polyacetal

RoHS-compliant

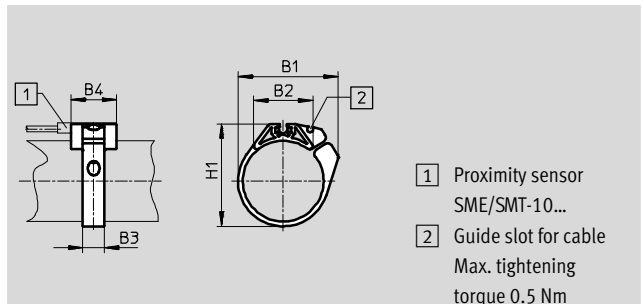

- 1 Proximity sensor SME/SMT-10...
- 2 Guide slot for cable  
Max. tightening torque 0.5 Nm

| Dimensions and ordering data |      |      |                 |                 |      |          |            |
|------------------------------|------|------|-----------------|-----------------|------|----------|------------|
| For piston $\varnothing$     | B1   | B2   | B3<br>$\pm 0.1$ | B4<br>$\pm 0.1$ | H1   | Part No. | Type       |
| 6                            | 15.6 | 9.4  | 7               | 19              | 13.5 | 173226   | SMBR-10-6  |
| 8                            | 18.9 | 12.3 | 7               | 19              | 17.5 | 175101   | SMBR-10-8  |
| 10                           | 20.4 | 13.7 | 7               | 19              | 19.9 | 173227   | SMBR-10-10 |
| 12                           | 22.7 | 14.3 | 7               | 19              | 21.9 | 175102   | SMBR-10-12 |
| 16                           | 26.1 | 17   | 7               | 19              | 25.7 | 173228   | SMBR-10-16 |
| 20                           | 33.2 | 20.8 | 9               | 19              | 30.4 | 175103   | SMBR-10-20 |
| 25                           | 36.5 | 22.6 | 9               | 19              | 35.6 | 175104   | SMBR-10-25 |
| 32                           | 41.7 | 24.5 | 9               | 19              | 42.7 | 175105   | SMBR-10-32 |
| 40                           | 47   | 26.5 | 9               | 19              | 50.7 | 175106   | SMBR-10-40 |
| 50                           | 56.4 | 28.6 | 9               | 19              | 61.5 | 175107   | SMBR-10-50 |
| 63                           | 69.4 | 32   | 9               | 19              | 74.5 | 175108   | SMBR-10-63 |



# Proximity sensors SMT/SME-10, for C-slot

Accessories

## Positioning component SMM

Insertable in slot lengthwise

Ambient temperature: -40 ... +120 °C

Materials:

Housing: Anodised wrought aluminium alloy

Screws: High-alloy stainless steel

Note on materials:

RoHS-compliant

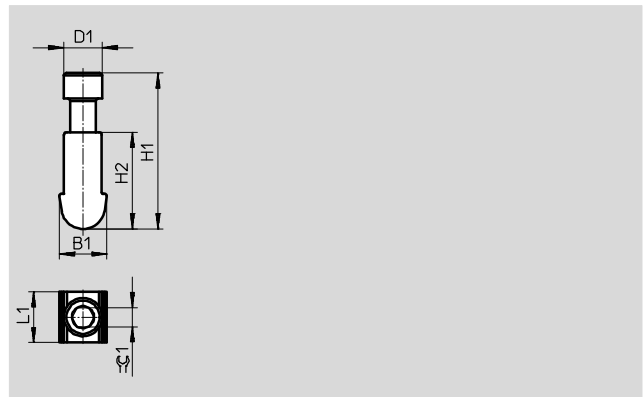

| Dimensions and ordering data |     |       |     |     |     |                   |        | Part No. | Type | PU <sup>2)</sup> |
|------------------------------|-----|-------|-----|-----|-----|-------------------|--------|----------|------|------------------|
| B1                           | D1  | H1    | H2  | L1  | ∅1  | CRC <sup>1)</sup> |        |          |      |                  |
| 3.75                         | 3.0 | 12.23 | 7.6 | 4.0 | 1.5 | 3                 | 547942 | SMM-10   | 10   |                  |

1) Corrosion resistance class 4 according to Festo standard 940 070

Components subject to particularly high corrosion stress. Parts used with aggressive media, e.g. in the food or chemical industry. These applications should be supported with special tests with the media if required.

2) Packaging unit

| Ordering data – Connecting cables |                   |                  |          | Technical data → Internet: nebu |                     |  |
|-----------------------------------|-------------------|------------------|----------|---------------------------------|---------------------|--|
| Type                              | Number of wires   | Cable length [m] | Part No. | Type                            |                     |  |
| Socket M8x1, 3-pin                |                   |                  |          |                                 |                     |  |
|                                   | For SMT/SME-10... | 3                | 2.5      | 541333                          | NEBU-M8G3-K-2.5-LE3 |  |
|                                   |                   |                  | 5        | 541334                          | NEBU-M8G3-K-5-LE3   |  |
|                                   | For SMT/SME-10... | 3                | 2.5      | 541338                          | NEBU-M8W3-K-2.5-LE3 |  |
|                                   |                   |                  | 5        | 541341                          | NEBU-M8W3-K-5-LE3   |  |

| Ordering data – Mounting attachments |       |          |               |
|--------------------------------------|-------|----------|---------------|
|                                      | For ∅ | Part No. | Type          |
|                                      | 6     | 173205   | WSM-6-SME-10  |
|                                      | 8     | 173206   | WSM-8-SME-10  |
|                                      | 10    | 173207   | WSM-10-SME-10 |
|                                      | -     | 534255   | SMBK-10       |

| Ordering data – Sensor tester |        |           |
|-------------------------------|--------|-----------|
| Part No.                      | Type   |           |
|                               | 158481 | SM-TEST-1 |

| Ordering data             |         |          |             |                  |
|---------------------------|---------|----------|-------------|------------------|
|                           | Size    | Part No. | Type        | PU <sup>1)</sup> |
| <b>Inscription labels</b> |         |          |             |                  |
|                           | 23x4 mm | 541598   | ASLR-L-423  | 34               |
| <b>Safety clips</b>       |         |          |             |                  |
|                           | M8      | 548067   | NEAU-M8-GD  | 1                |
|                           | M12     | 548068   | NEAU-M12-GD | 1                |

1) Packaging unit per frame