

Mini slides SLTE, electric



# Mini slides SLTE, electric

Key features

FESTO

## Range of applications

The electric mini slide SLTE is ideal for use in automation applications where controlled end-position cushioning (gentle stopping), constant travel speed and positioning capability are important factors.

The SLTE has the same interfaces on the yoke, slide and underneath the housing as the pneumatic SLT. It is also fully compatible with the modular handling and assembly system and SLT adapter kits.

## Special features

- Precise and rigid guide
- Freely positionable
- Fast positioning times
- Through-holes from above and below
- Sensors can be integrated
- Gentle starting and stopping
- Working loads up to 4 kg
- Constant travel speeds of 2 ... 200 mm/s

## Everything from a single source

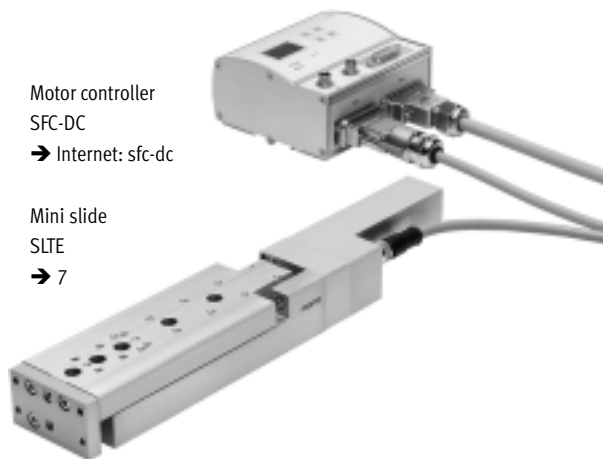

The mini slide SLTE and motor controller SFC form one unit.

- Thanks to the protection class IP54, the SFC can be mounted close to the SLTE, either:
  - with centre supports
  - on an H-rail
- Only one cable required between SLTE and SFC
- Motor controller SFC available with or without control panel
- Easy control with
  - I/O interface
  - Profibus
  - CANopen
  - DeviceNet

Parameterisation possible via

- Control panel:
  - Suitable for simple position sequences
- Configuration package FCT (Festo configuration tool):
  - Parameterisation via RS 232 interface
  - Windows-based PC user interface (Festo configuration tool)



## The technology in detail

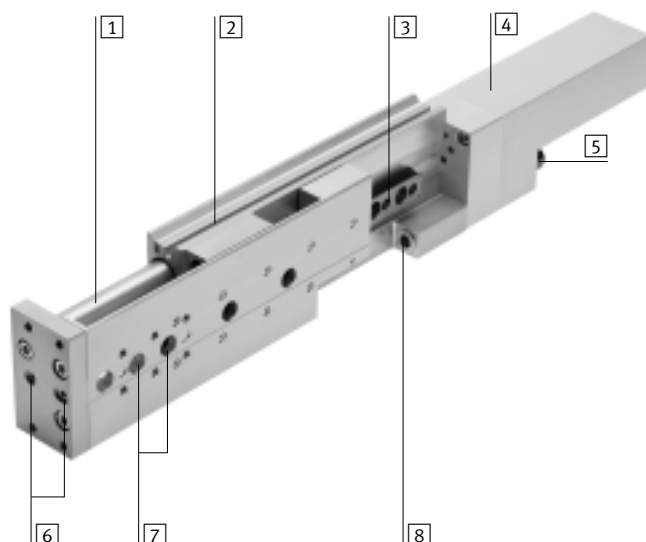

- 1 Drive rod
- 2 Slot for reference switch
- 3 Roller bearing guide
- 4 Drive assembly consisting of DC motor with displacement encoder
- 5 Electrical connection
- 6 Threaded holes and through-holes with centring hole for attaching the working load
- 7 Threaded holes and through-holes with centring hole for attaching the SLTE
- 8 Fixed stop with integrated rubber buffer

PROFIBUS®, DeviceNet®, CANopen® is a registered trademark of its respective trademark holder in certain countries.

# Mini slides SLTE, electric

Key features

## Comparison between electric mini slide SLTE and pneumatic mini slide SLT

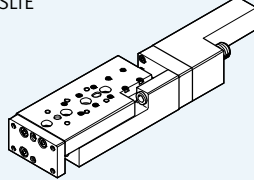
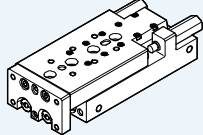
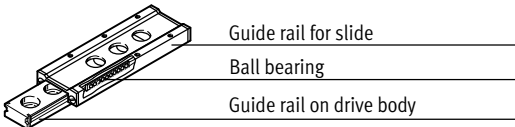
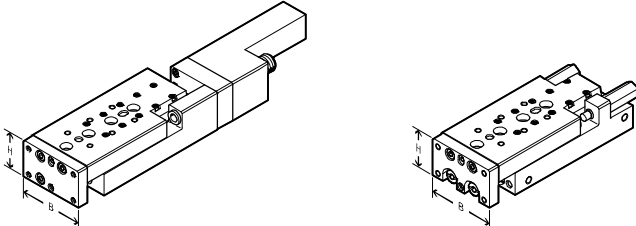
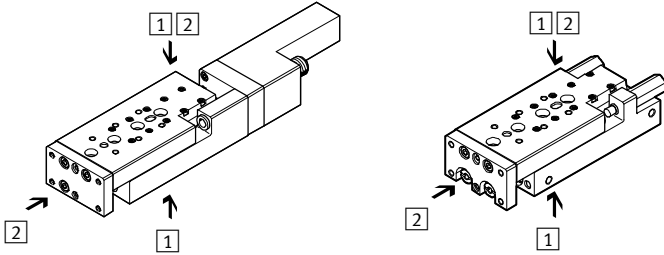
	<p>Electrical: SLTE</p> 	<p>Pneumatic: SLT</p> 												
<p><b>Advantages</b></p>														
	<ul style="list-style-type: none"> <li>• Gentle starting and stopping</li> <li>• Constant and precise speed (2 ... 200 mm/s)</li> <li>• Flexible positioning without mechanical devices</li> <li>• Programmable drive profile</li> </ul>	<ul style="list-style-type: none"> <li>• High feed force</li> <li>• High speed</li> <li>• Fast positioning time</li> <li>• Compact length</li> </ul>												
<p><b>Guide</b></p>														
<ul style="list-style-type: none"> <li>• Preloaded, backlash-free, precise and rigid ball bearing cage guide</li> <li>• High torque and load absorption</li> </ul>	 <p>Guide rail for slide</p> <p>Ball bearing</p> <p>Guide rail on drive body</p>													
<p><b>Dimensions</b></p>														
<ul style="list-style-type: none"> <li>• Identical width and height dimensions</li> </ul> <table border="1" data-bbox="156 1099 464 1189"> <thead> <tr> <th>Type</th> <th>Width (W)</th> <th>x</th> <th>Height (H)</th> </tr> </thead> <tbody> <tr> <td>SLT(E)-10</td> <td>50</td> <td>x</td> <td>30 mm</td> </tr> <tr> <td>SLT(E)-16</td> <td>66</td> <td>x</td> <td>40 mm</td> </tr> </tbody> </table>	Type	Width (W)	x	Height (H)	SLT(E)-10	50	x	30 mm	SLT(E)-16	66	x	40 mm		
Type	Width (W)	x	Height (H)											
SLT(E)-10	50	x	30 mm											
SLT(E)-16	66	x	40 mm											
<p><b>Interfaces</b></p>														
<ul style="list-style-type: none"> <li>• Identical mounting and attachment options</li> </ul> <p>1 Attachment surfaces: Direct mounting using threaded holes and through-holes</p> <p>2 Mounting surfaces: Direct mounting of loads and devices (e.g. SLT: semi-rotary drives and grippers) via threaded holes in the slide and the yoke plate</p>														
<p><b>Technical data</b></p>														
<p>Piston Ø</p>	<p>[mm] 10, 16</p>	<p>6 ... 25</p>												
<p>Stroke</p>	<p>[mm] 50 ... 150</p>	<p>10 ... 200</p>												
<p>Max. speed</p>	<p>[m/s] 0.2</p>	<p>0.8</p>												
<p>Repetition accuracy at end positions</p>	<p>[mm] ±0.1</p>	<p>±0.02</p>												
<p>Intermediate positions</p>	<p>Any</p>	<p>None</p>												

# Mini slides SLTE, electric

Key features

System product for handling and assembly technology

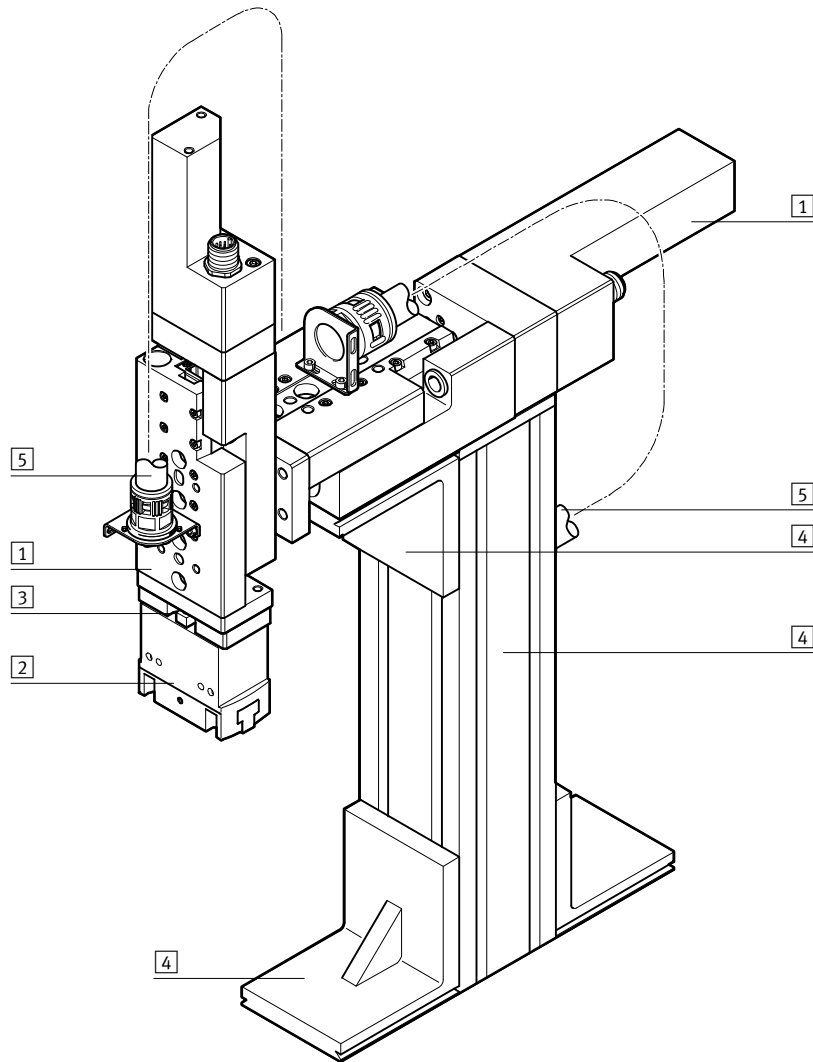

System elements and accessories		
	Brief description	→ Page/Internet
1	Axes	Wide range of combinations possible within handling and assembly technology axes
2	Grippers	Wide range of variations possible within handling and assembly technology gripper
3	Adapters	For drive/drive and drive/gripper combinations adapter kit
4	Basic mounting components	Profiles and profile connectors as well as profile/drive connectors basic component
5	Installation components	For manageable and secure guidance of electrical cables and tubing installation component
-	Drive units	Wide range of combinations possible within handling and assembly technology drive

# Mini slides SLTE, electric

Peripherals overview

Size 10/16

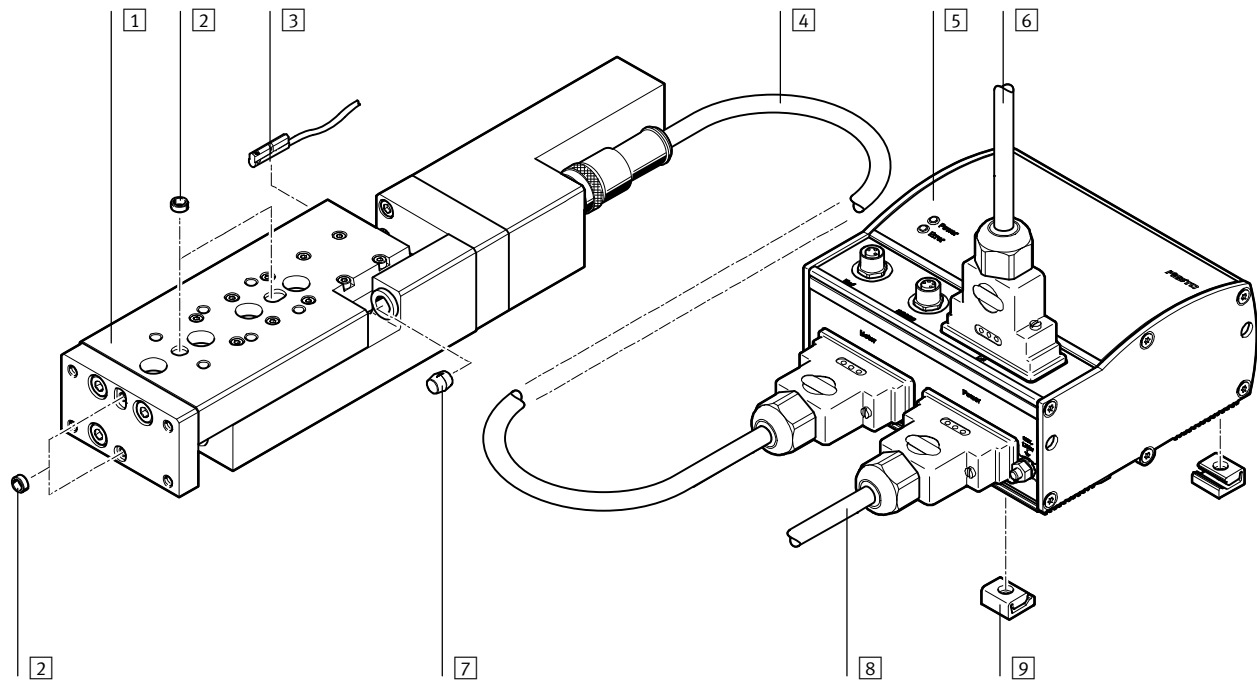

Accessories		Brief description	→ Page/Internet
1	Mini slide SLTE	Electromechanical linear axis with lead screw spindle	7
2	Centring pin/sleeve ZBS/ZBH	– For centring loads and attachment components – Centring sleeves included in scope of delivery	15
3	Proximity sensor SME/SMT-10	For referencing mini slide or for sensing slide position	15
4	Motor cable KMTR	Connecting cable between motor and motor controller	kmtr
5	Motor controller SFC	For parameterising and positioning mini slide	sfc-dc
6	Control cable KES	For I/O connection to any controller	kes
6	Plug FBS, FBA	For fieldbus interface	plug
7	Buffer	Buffer included in scope of delivery	–
8	Supply cable KPWR	Power supply cable; load and logic power supplies are isolated	kpwr
9	Centre supports MUP	– For mounting motor controller – Motor controller can also be mounted on H-rail	mup

# Mini slides SLTE, electric

Type codes

SLTE – 16 – 80 – LS – G04

**Type**

SLTE	Mini slide
------	------------

**Size**

**Stroke [mm]**

**Drive spindle/pitch**

LS	Lead screw
----	------------

**Gearing type**

G04	Gear unit ratio $i = 4.4$
-----	---------------------------

# Mini slides SLTE, electric

Technical data

Function

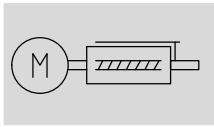

- - Size  
10 and 16
- - Stroke length  
50 ... 150 mm



General technical data		
Size	10	16
Constructional design	Electromechanical linear axis with lead screw	
Guide	With ball bearings	
Type of mounting	Via through-holes	
	Via female thread	
	Via female thread and centring sleeve	
Stroke [mm]	50, 80	50, 80, 100, 150
Stroke reserve with rubber buffer at both ends [mm]	0.5	0.6
position with rubber buffer at one end [mm]	1.2	1.25
Assembly position	Any	
Lead screw pitch [mm]	5	7.5
Min. travel speed [mm/s]	2	
Max. acceleration [m/s <sup>2</sup> ]	2.5	
Repetition accuracy [mm]	±0.1	
Reversing backlash [mm]	< 0.1	

Electrical data for motor		
Size	10	16
System resolution of encoder	512 (pulses per rotation)	1,000 (pulses per rotation)
Nominal operating voltage [V DC]	24	
Output [W]	4.5	18

Operating and environmental conditions		
Size	10	16
Ambient temperature [°C]	0 ... +40	
Protection class	IP40	
Fast transients	To EN61000-4-4	
Max. noise level <sup>1)</sup> [dB A]	< 50	< 55
CE symbol (declaration of conformity)	In accordance with EU EMC directive	
Certification	C-Tick	

1) At maximum permissible speed

Weight [g]							
Size	10			16			
	50	80		50	80	100	150
Product weight	574	737		1,185	1,465	1,714	2,196
Moving load	163	235		296	415	519	729

# Mini slides SLTE, electric

Technical data

## Materials

Sectional view

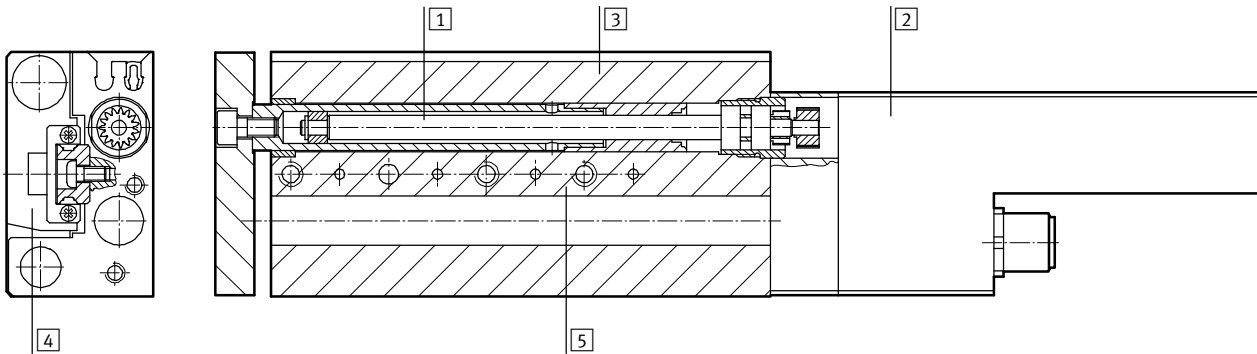

## Mini slide

1	Lead screw	High-alloy steel
2	Motor housing	Wrought aluminium alloy, anodised
3	Housing	Wrought aluminium alloy, anodised
4	Slide	Wrought aluminium alloy, anodised
5	Guide	Tempered steel
-	Seals	Thermoplastic rubber, nitrile rubber

## Travel speed $v$ as a function of applied load $m$

Horizontal mounting position

SLTE-10

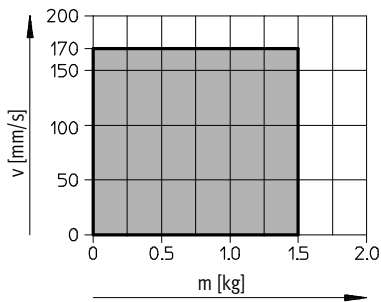

SLTE-16

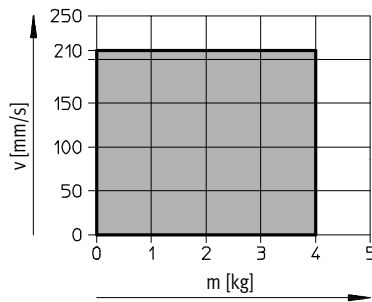

Vertical mounting position

SLTE-10

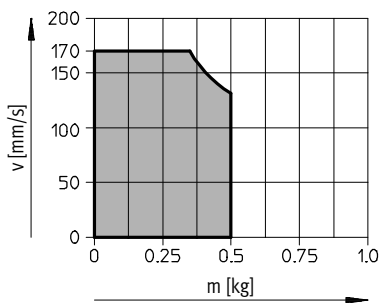

SLTE-16

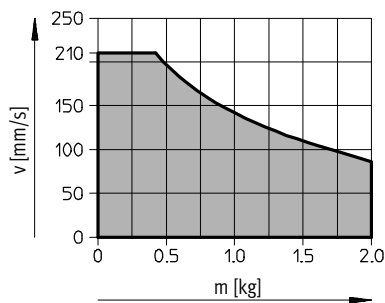

█ Permissible operating range



# Mini slides SLTE, electric

Technical data

## Positioning time $t$ as a function of stroke $l$

SLTE-10

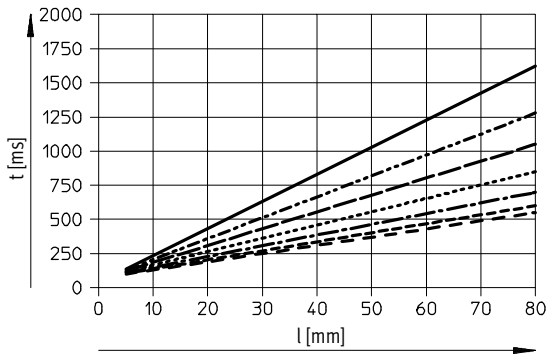

- $v = 50$  mm/s
- - -  $v = 65$  mm/s
- · -  $v = 80$  mm/s
- · ·  $v = 100$  mm/s
- - -  $v = 125$  mm/s
- · -  $v = 150$  mm/s
- · -  $v = 170$  mm/s

SLTE-16

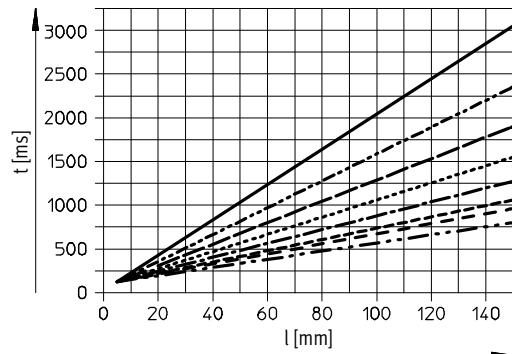

- $v = 50$  mm/s
- - -  $v = 65$  mm/s
- · -  $v = 80$  mm/s
- · ·  $v = 100$  mm/s
- - -  $v = 125$  mm/s
- · -  $v = 150$  mm/s
- · -  $v = 170$  mm/s
- · -  $v = 210$  mm/s

## Reference travel

to fixed stop

- Positive fixed stop
  - To front stop bush (extended)
- Negative fixed stop
  - To rear stop bush (retracted)

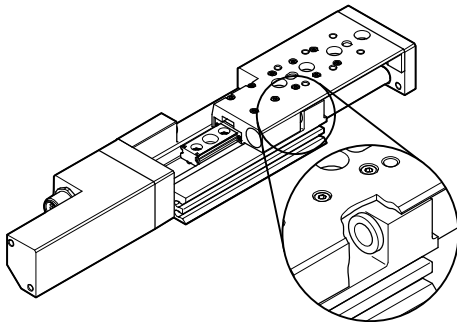

to proximity sensor

- Position freely selectable

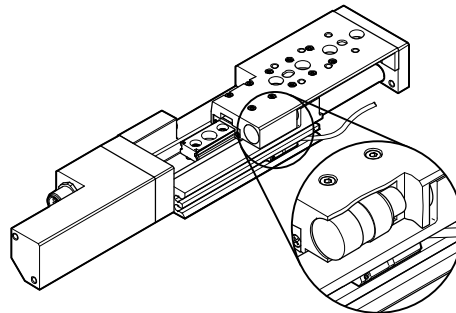

## The following applies for reference travel to a fixed stop:

Positive fixed stop

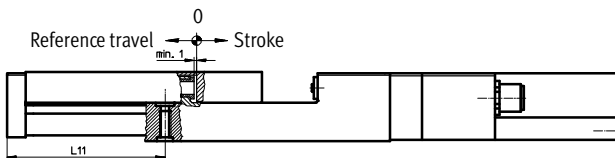

Negative fixed stop

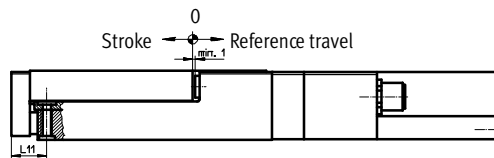

Size	Stroke	L11	
		Positive fixed stop	Negative fixed stop
10	50	67.4 <sup>+1.1</sup>	15.6 <sup>-1.1</sup>
	80	97.0 <sup>+1.1</sup>	15.2 <sup>-1.1</sup>
16	50	74.9 <sup>+1.1</sup>	23.1 <sup>-1.1</sup>
	80	104.1 <sup>+1.1</sup>	22.3 <sup>-1.1</sup>
	100	124.6 <sup>+1.1</sup>	22.8 <sup>-1.1</sup>
	150	173.3 <sup>+1.1</sup>	21.5 <sup>-1.1</sup>

# Mini slides SLTE, electric

Technical data

## Dynamic characteristic load values

Torques are indicated with reference to the centre of the guide.

They must not be exceeded in the dynamic range. Special attention must be paid to the cushioning phase.

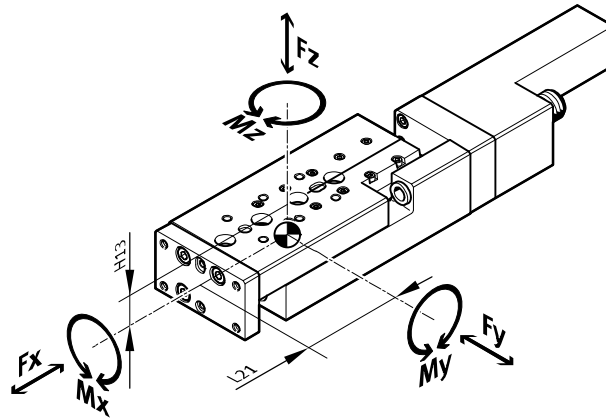

If the drive is subjected to more than two of the indicated forces and torques simultaneously, the following equation must be satisfied in addition to the indicated maximum loads:

$$\frac{|F_y|}{F_{y_{max}}} + \frac{|F_z|}{F_{z_{max}}} + \frac{|M_x|}{M_{x_{max}}} + \frac{|M_y|}{M_{y_{max}}} + \frac{|M_z|}{M_{z_{max}}} \leq 1$$

## Position of the guide centre

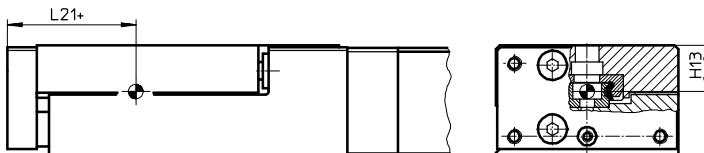

+ plus stroke length

Permissible forces and torques						Geometric characteristics	
Size	Stroke	F <sub>y</sub> max [N]	F <sub>z</sub> max [N]	M <sub>x</sub> max, M <sub>y</sub> max [Nm]	M <sub>z</sub> max [Nm]	H13 [mm]	L21 [mm]
10							
	50	390	390	3.1	1.4	13	33.5
	80	410	410	4.3	1.5		41
16							
	50	510	510	4.6	2.8	16	35
	80	520	520	6.0	2.8		41.5
	100	600	600	9.1	3.2		51.5
	150	660	960	12.6	3.5		66.5

-  - Note  
 Sizing software  
 PositioningDrives  
 → [www.festo.com](http://www.festo.com)

# Mini slides SLTE, electric

Technical data

## Calculation example

Given

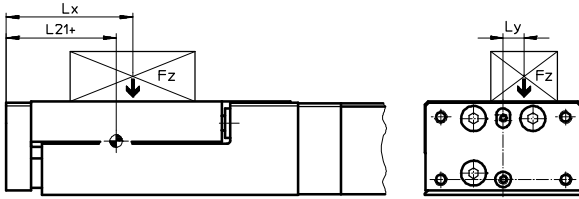

Mini slide = SLTE-10  
 Stroke length = 80 mm  
 Lever arm  $L_x$  = 50 mm  
 Lever arm  $L_y$  = 30 mm  
 Weight  $F_z$  = 0.8 kg  
 Acceleration  $a$  = 0 m/s<sup>2</sup>

To be found

$F_y, F_z, M_x, M_y, M_z$   
 and verification of function with  
 combined load

Solution:

$L_{21} = 41$  mm from table

$F_y = 0$  N

$F_z = m \times g$   
 $= 0.8 \text{ kg} \times 9.81 \text{ m/s}^2 = 7.848 \text{ N}$

$M_x = m \times g \times L_y$   
 $= 0.8 \text{ kg} \times 9.81 \text{ m/s}^2 \times 30 \text{ mm} = 0.236 \text{ Nm}$

$M_y = m \times g \times [(L_{21} + \text{stroke}) - L_x]$   
 $= 0.8 \text{ kg} \times 9.81 \text{ m/s}^2 [(41 \text{ mm} + 80 \text{ mm}) - 50 \text{ mm}] = 0.557 \text{ Nm}$

$M_z = 0$  Nm

Combined load:

$$\frac{|F_y|}{F_{y\max.}} + \frac{|F_z|}{F_{z\max.}} + \frac{|M_x|}{M_{x\max.}} + \frac{|M_y|}{M_{y\max.}} + \frac{|M_z|}{M_{z\max.}}$$

$$= 0 + \frac{7.848\text{N}}{410\text{N}} + \frac{0.2366\text{Nm}}{4.3\text{Nm}} + \frac{0.557\text{Nm}}{1.5\text{Nm}} + 0 = 0.445 \leq 1$$

## Pin allocation of connection plug

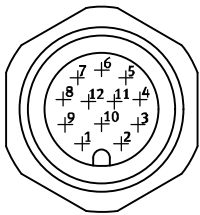

Plug M12		
Pin	Connection	Function
1	Motor +	Motor conductor
2	Motor -	Motor conductor
3	A	Encoder signal RS 485
4	A/	Encoder signal RS 485
5	B	Encoder signal RS 485
6	B/	Encoder signal RS 485
7	I	Encoder signal RS 485
8	I/	Encoder signal RS 485
9	+5 V DC	Signal supply
10	0 V	Signal ground
11	-	-
12	-	-

# Mini slides SLTE, electric

Technical data



## Dimensions

Download CAD data → [www.festo.com](http://www.festo.com)

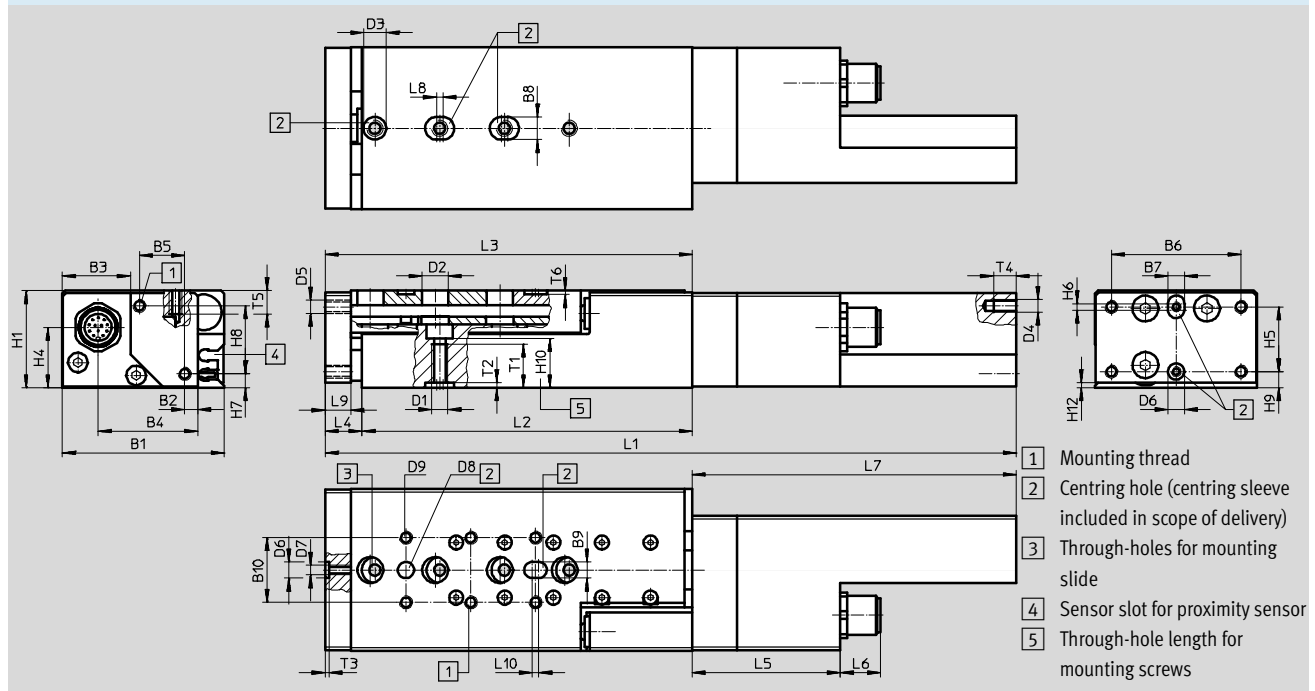

Size	B1	B2	B3	B4	B5	B6	B7	B8	B9	B10	D1	D2	D3	D4
		±0.3	±0.3				H7	H7	H7			∅	∅	
10	50	30.8	20.8	4	14	40	5	5	5	20	M5	8	7	M4
16	66	45.7	24.3	4.2	25	55	7	9	5	20	M6	10	9	M4

Size	D5	D6	D7	D8	D9	H1	H4	H5	H6	H7	H8	H9	H10	H12
		∅ H7		∅ H7										
10	M4	5	M3	5	M4	30	18.4	20	2	4	21	5	15	1.5
16	M5	7	M4	5	M5	40	25.8	20	2	4.5	30	13	20	1.5

Size	Stroke [mm]	L1 ±1.5		L2	L3 ±1		L4 ±1	
		1)	2)		1)	2)	1)	2)
10	50	212	213	102	112	113	10	11.1
	80	262	263	152	162	163	9.6	10.7
16	50	262.5	263.5	100	112.5	113.5	12.5	13.5
	80	307.5	308.5	146	158	159	11.7	12.7
	100	349	350	187	199.5	200.5	12.2	13.2
	150	430.5	431.5	270	281	282	11	12

Size	L5	L6	L7	L8	L9	L10	T1	T2	T3	T4	T5	T6
	±0.5											
10	45.8	12.5	100	2	8	2	12	1.5	1.2	7	8	1.2
16	56.3	12.5	149.7	2	10	1	16	2.1	1.5	7	7	1.2

- 1) End position at fixed stop  
 2) End position at rubber buffer

# Mini slides SLTE, electric

Technical data

## Hole pattern for mounting thread and centring holes

SLTE-10-50

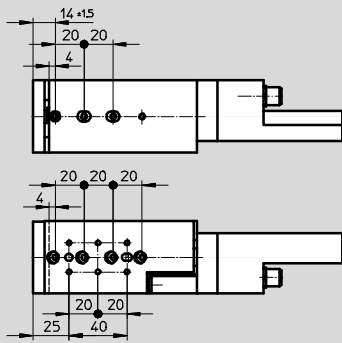

SLTE-10-80

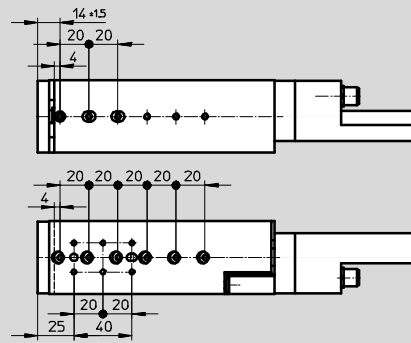

SLTE-16-50

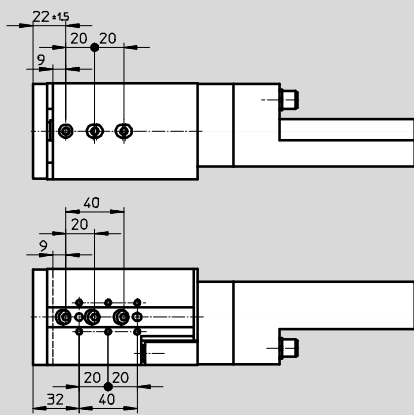

SLTE-16-80

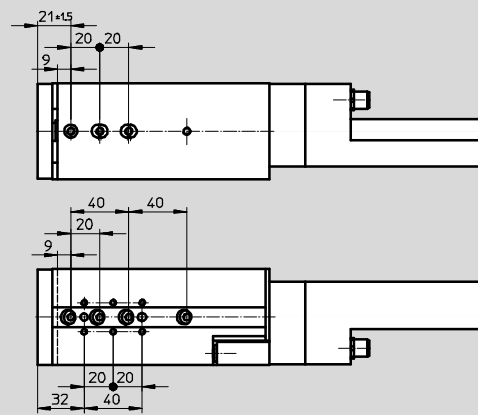

SLTE-16-100

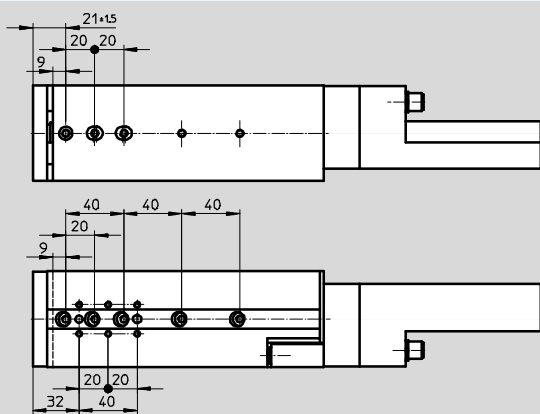

SLTE-16-150

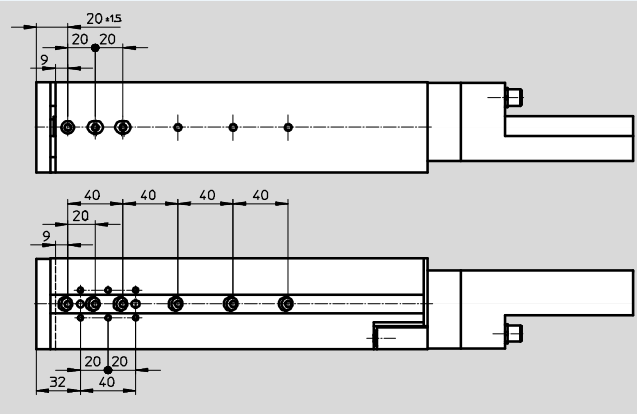

# Mini slides SLTE, electric

Technical data

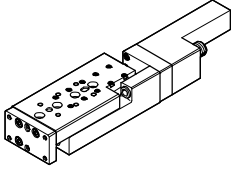
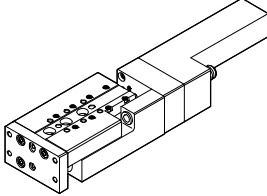
Ordering data			
Size	Brief description	Part No.	Type
10			
	Mini slide	537 447	SLTE-10-50-LS-G04
		537 449	SLTE-10-80-LS-G04
16			
	Mini slide	537 459	SLTE-16-50-LS-G04
		537 461	SLTE-16-80-LS-G04
		537 463	SLTE-16-100-LS-G04
		537 465	SLTE-16-150-LS-G04



# Mini slides SLTE, electric



Accessories



**FESTO**

Ordering data – Centring sleeves <sup>1)</sup>				Technical data → Internet: zbh	
Size	10		16		
	Part No.	Type	Part No.	Type	
	Housing	<b>186 717</b>	<b>ZBH-7</b>	<b>150 927</b>	<b>ZBH-9</b>
	Slide	<b>189 652</b>	<b>ZBH-5</b>	<b>189 652</b>	<b>ZBH-5</b>
	Yoke	<b>189 652</b>	<b>ZBH-5</b>	<b>186 717</b>	<b>ZBH-7</b>

1) Scope of delivery: 10 per pack

Ordering data – Proximity sensors for C-slot, magneto-resistive					Technical data → Internet: smt	
	Type of mounting	Switch output	Electrical connection, connection direction	Cable length [m]	Part No.	Type
N/O contact						
	Insertable in the slot from above	PNP	Cable, 3-wire, in-line	2.5	<b>551 373</b>	<b>SMT-10M-PS-24V-E-2,5-L-OE</b>
			Plug M8x1, 3-pin, in-line	0.3	<b>551 375</b>	<b>SMT-10M-PS-24V-E-0,3-L-M8D</b>
			Plug M8x1, 3-pin, lateral	0.3	<b>551 376</b>	<b>SMT-10M-PS-24V-E-0,3-Q-M8D</b>
	Insertable in the slot lengthwise	PNP	Plug M8x1, 3-pin, in-line	0.3	<b>173 220</b>	<b>SMT-10-PS-SL-LED-24</b>
			Cable, 3-wire, in-line	2.5	<b>173 218</b>	<b>SMT-10-PS-KL-LED-24</b>

Ordering data – Proximity sensors for C-slot, magnetic reed					Technical data → Internet: sme	
	Type of mounting	Switch output	Electrical connection, connection direction	Cable length [m]	Part No.	Type
N/O contact						
	Insertable in the slot from above	Contacting	Plug M8x1, 3-pin, in-line	0.3	<b>551 367</b>	<b>SME-10M-DS-24V-E-0,3-L-M8D</b>
			Cable, 3-wire, in-line	2.5	<b>551 365</b>	<b>SME-10M-DS-24V-E-2,5-L-OE</b>
			Cable, 2-wire, in-line	2.5	<b>551 369</b>	<b>SME-10M-ZS-24V-E-2,5-L-OE</b>
	Insertable in the slot lengthwise	Contacting	Plug M8x1, 3-pin, in-line	0.3	<b>173 212</b>	<b>SME-10-SL-LED-24</b>
			Cable, 3-wire, in-line	2.5	<b>173 210</b>	<b>SME-10-KL-LED-24</b>

Ordering data – Connecting cables				Technical data → Internet: nebu	
	Electrical connection, left	Electrical connection, right	Cable length [m]	Part No.	Type
	Straight socket, M8x1, 3-pin	Cable, open end, 3-wire	2.5	<b>541 333</b>	<b>NEBU-M8G3-K-2.5-LE3</b>
			5	<b>541 334</b>	<b>NEBU-M8G3-K-5-LE3</b>
	Angled socket, M8x1, 3-pin	Cable, open end, 3-wire	2.5	<b>541 338</b>	<b>NEBU-M8W3-K-2.5-LE3</b>
			5	<b>541 341</b>	<b>NEBU-M8W3-K-5-LE3</b>

# Mini slides SLTE, electric

Accessories



**Adapter kit**  
**HAPS, HMSV**

Material:  
Wrought aluminium alloy  
Free of copper and PTFE  
RoHS-compliant

 Note  
The kit includes the individual mounting interface as well as the necessary mounting material.

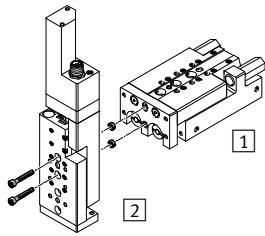
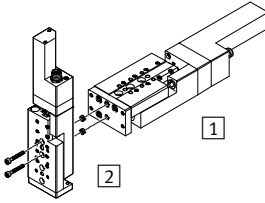
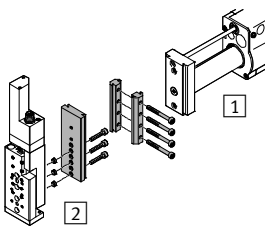
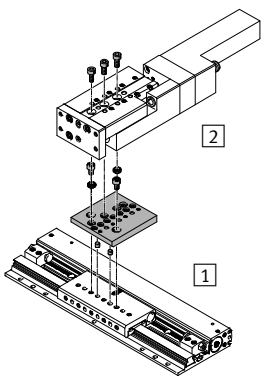
Permissible drive/drive combinations with adapter kit							Download CAD data → <a href="http://www.festo.com">www.festo.com</a>	
Combination	1	2	Adapter kit					
	Drive	Drive	CRC <sup>1)</sup>	Part No.	Type	Required quantity	PU <sup>2)</sup>	
SLT/SLTE	SLT	SLTE						
	16	10	2	-	M4x25 DIN 912 <sup>3)</sup>	2	-	
				186717	ZBH-7 <sup>4)</sup>	2	10	
	20	16		-	M5x30 DIN 912 <sup>3)</sup>	2	-	
				150927	ZBH-9 <sup>4)</sup>	2	10	
SLTE/SLTE	SLTE	SLTE						
	16	10	2	-	M4x25 DIN 912 <sup>3)</sup>	2	-	
				186717	ZBH-7 <sup>4)</sup>	2	10	
HMP/SLTE	HMP	SLTE	HMSV					
	16, 20	10	2	178330	HMSV-35	1	1	
	16, 20, 25	16		178331	HMSV-36	1	1	
SLG/SLTE	SLG	SLTE	HAPS					
	12	10	2	189533	HAPS-11	1	1	
	18	10, 16		189534	HAPS-12	1	1	

- 1) Corrosion resistance class CRC 2 to Festo standard FN 940070  
Moderate corrosion stress. Indoor applications in which condensation may occur. External visible parts with primarily decorative requirements for the surface and which are in direct contact with the ambient atmosphere typical for industrial applications.
- 2) Packaging unit quantity
- 3) The screws listed are not included in the scope of delivery of the drives
- 4) The centring sleeves are included in the scope of delivery of the drives



# Mini slides SLTE, electric

Accessories

**Adapter kit  
HMSV**

Material:  
Wrought aluminium alloy  
Free of copper and PTFE  
RoHS-compliant

 Note  
The kit includes the individual mounting interface as well as the necessary mounting material.

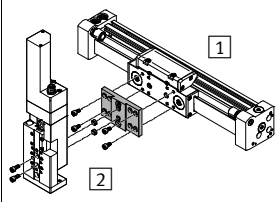
Permissible drive/drive combinations with adapter kit			Download CAD data → <a href="http://www.festo.com">www.festo.com</a>				
Combination	1 Drive	2 Drive	Adapter kit				
	Size	Size	CRC <sup>1)</sup>	Part No.	Type	Required quantity	PU <sup>2)</sup>
DGC/SLTE	DGC	SLTE	HMSV				
	18	10	2	<b>189656</b>	<b>HMSV-40</b>	1	1
	18	16		<b>189657</b>	<b>HMSV-41</b>	1	1
	25	16		<b>189658</b>	<b>HMSV-42</b>	1	1

- 1) Corrosion resistance class CRC 2 to Festo standard FN 940070  
Moderate corrosion stress. Indoor applications in which condensation may occur. External visible parts with primarily decorative requirements for the surface and which are in direct contact with the ambient atmosphere typical for industrial applications.
- 2) Packaging unit quantity