

Motor controllers SFC-DC



Motor controllers SFC-DC

Key features



Hardware

- The motor controller SFC-DC serves as a positioning controller and closed loop position controller
- Available with or without control panel
- Thanks to IP54 protection, the motor controller can be mounted close to the drive

Parameter assignment via:

- Control panel:
 - suitable for simple position sequences
- FCT (Festo Configuration Tool) configuration package:
 - with RS 232 interface
 - Windows-based PC user interface, Festo Configuration Tool

- Easy actuation via:
 - I/O interface (only in combination with mini slide SLTE)
 - Profibus
 - CANopen
 - DeviceNet



For controlling

Mini slide SLTE

Parallel gripper HGPLE

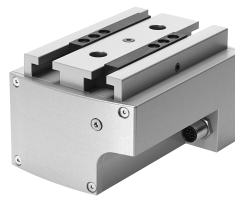

FHPP – Festo Handling and Positioning Profile

Optimised data profile

Festo has developed an optimised data profile, the “Festo Handling and Positioning Profile (FHPP)”, that is tailored to the target applications for handling and positioning tasks.

The FHPP data profile permits the actuation of Festo motor controllers, using a fieldbus interface, via standardised control and status bytes.

The following are defined, among others:

- Operating modes
- I/O data structure
- Parameter objects
- Sequence control

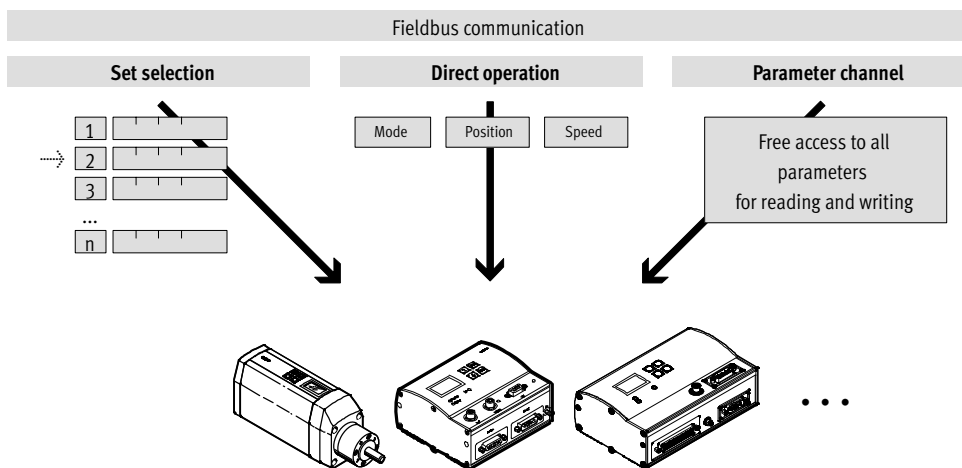
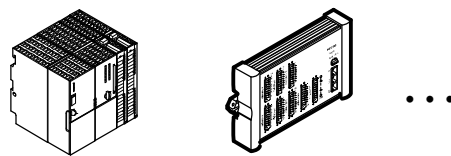

PROFIBUS®, DeviceNet®, CANopen® is a registered trademark of its respective trademark holder in certain countries.

Motor controllers SFC-DC

Key features



FCT software – Festo Configuration Tool

Software platform for electrical drives from Festo

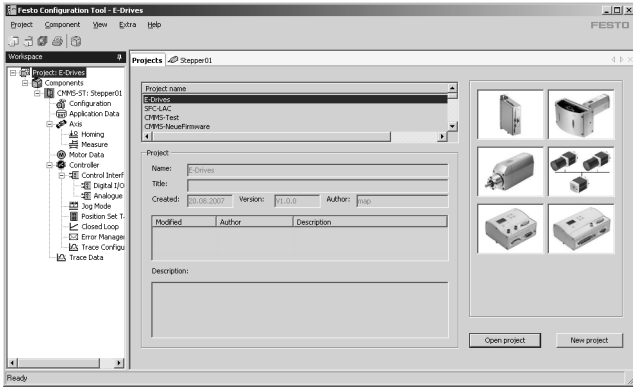

- All the drives in a system can be managed and archived in a common project
- Project and data management for all supported device types
- Simple to use thanks to graphically supported parameter entry
- Universal mode of operation for all drives
- Working offline at your desk or online at the machine

Mechanical reference positions and limit positions

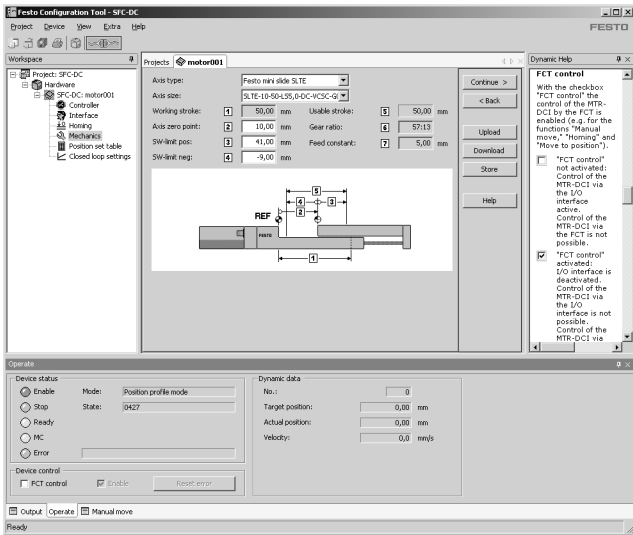

- Reference positions can be either edited or taught in
- Flexible adaptation to installation conditions
- Settings are displayed clearly

Position set table

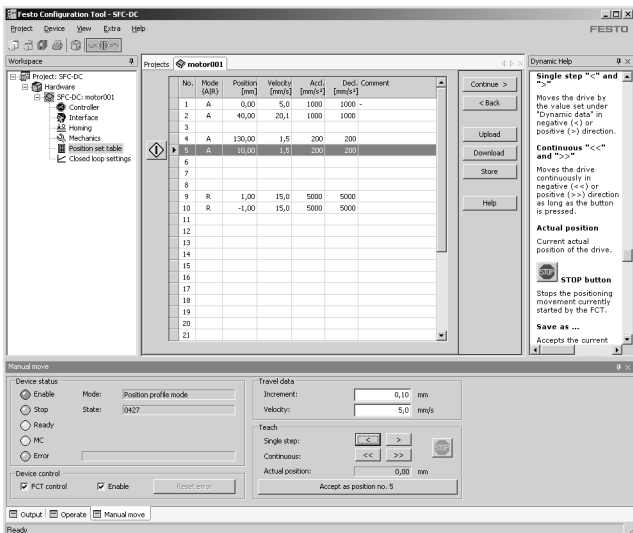

- 31 position sets ensure flexibility in positioning
- Absolute or relative positioning values can be used
- The following parameters can be set flexibly for each application:
 - Position
 - Speed
 - Acceleration
 - Braking ramps
- Complete function test

Motor controllers SFC-DC

Type codes

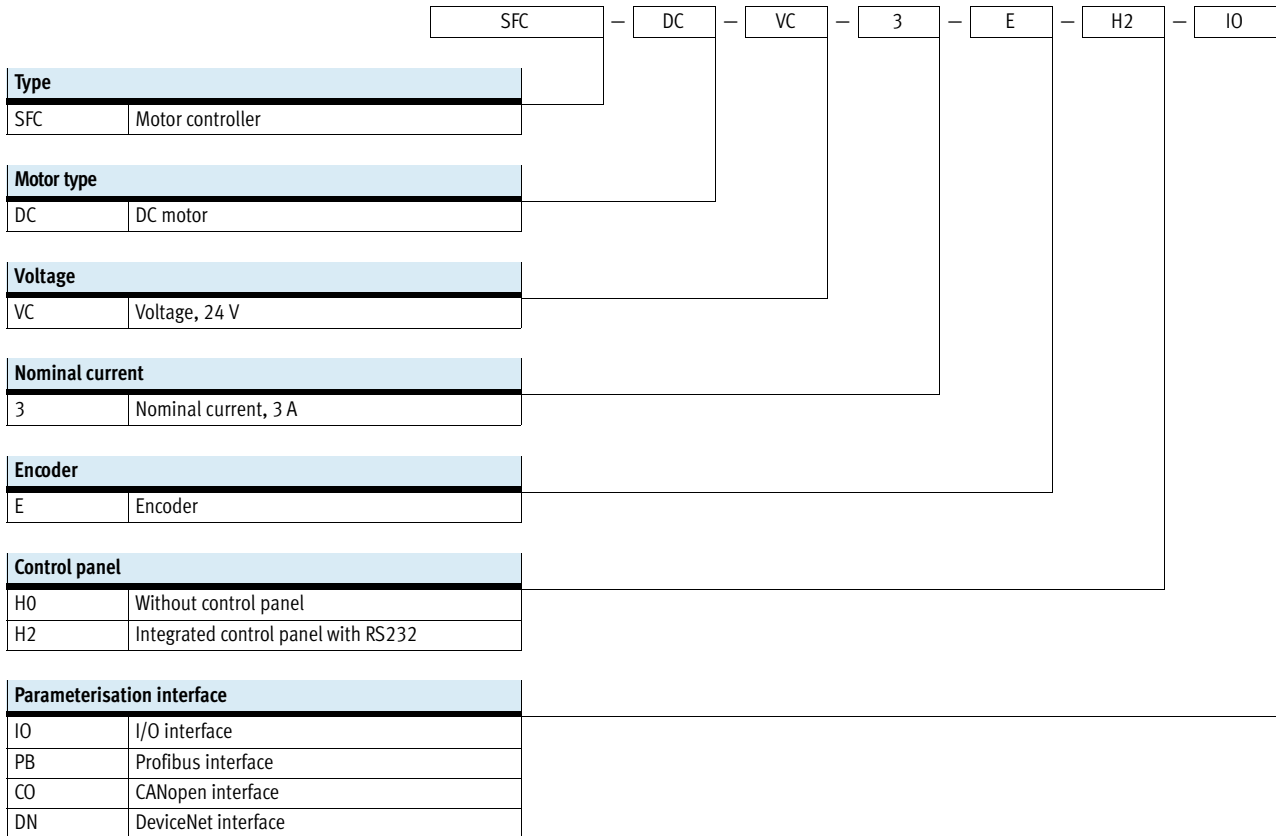

Motor controllers SFC-DC

Technical data

Fieldbus interfaces



General technical data				
Type	SFC-...-IO	SFC-...-PB	SFC-...-CO	SFC-...-DN
Operating mode	Cascade closed-loop controller with – P current regulator		– PI closed-loop speed controller – P position regulator	
Position sensor	Encoder			
Encoder input	RS485/RS422, A/B signal with index pulse			
Display (optional)	Four-key interface with full-text display via graphic LCD display (128 x 64 pixels)			
Control elements (optional)	4 keys			
Interface	I/O interface for 31 position sets and homing	Profibus DP	CANopen	DeviceNet
Number of digital logic inputs	8	–	–	–
Number of digital logic outputs	4	–	–	–
Bus terminating resistor ¹⁾	–	Not integrated in the device		
Communication profile	–	DP-V0/V1 / FHPP	DS301; / FHPP	FHPP
	–	Step7 functional modules	DS301; DSP402	Device Type 0C _h
Max. fieldbus baud rate	[Mbit/s]	–	12	1
Type of mounting	H-rail, wall or surface bracket			
Product weight	[g]	600		

1) Details of bus terminating resistor → 9

Electrical data		
General		
Rated output	[W]	75
Parameterisation interface	RS232; 9600 baud	
Load supply		
Nominal voltage	[V DC]	24 ±10%
Nominal current	[A]	3
Peak current	[A]	5
Logic supply		
Nominal voltage	[V DC]	24 ±10%
Nominal current	[A]	0.1
Peak current	[A]	0.8
Max. current per output (digital logic outputs)	[A]	0.5

Motor controllers SFC-DC

Technical data



Operating and environmental conditions				
Type	SFC-...-IO	SFC-...-PB	SFC-...-CO	SFC-...-DN
Digital logic outputs	Electrically isolated	-	-	-
Logic inputs	Electrically isolated	-	-	-
Specification, logic input	IEC 61131	-	-	-
Protection class	IP54			
Vibration resistance	To DIN EN 60068-2-6			
Shock resistance	To DIN EN 60068-2-27			
Protective function	I ² t monitoring			
	Current monitoring			
	Voltage failure detection			
	Lag error monitoring			
	Software end position detection			
CE mark (see declaration of conformity)	In accordance with EU EMC directive			
Ambient temperature	[°C]	0 ... +40		
Storage temperature	[°C]	-25 ... +60		
Relative air humidity	[%]	0 ... 95 (non-condensing)		
Certification	C-Tick			

Pin allocation

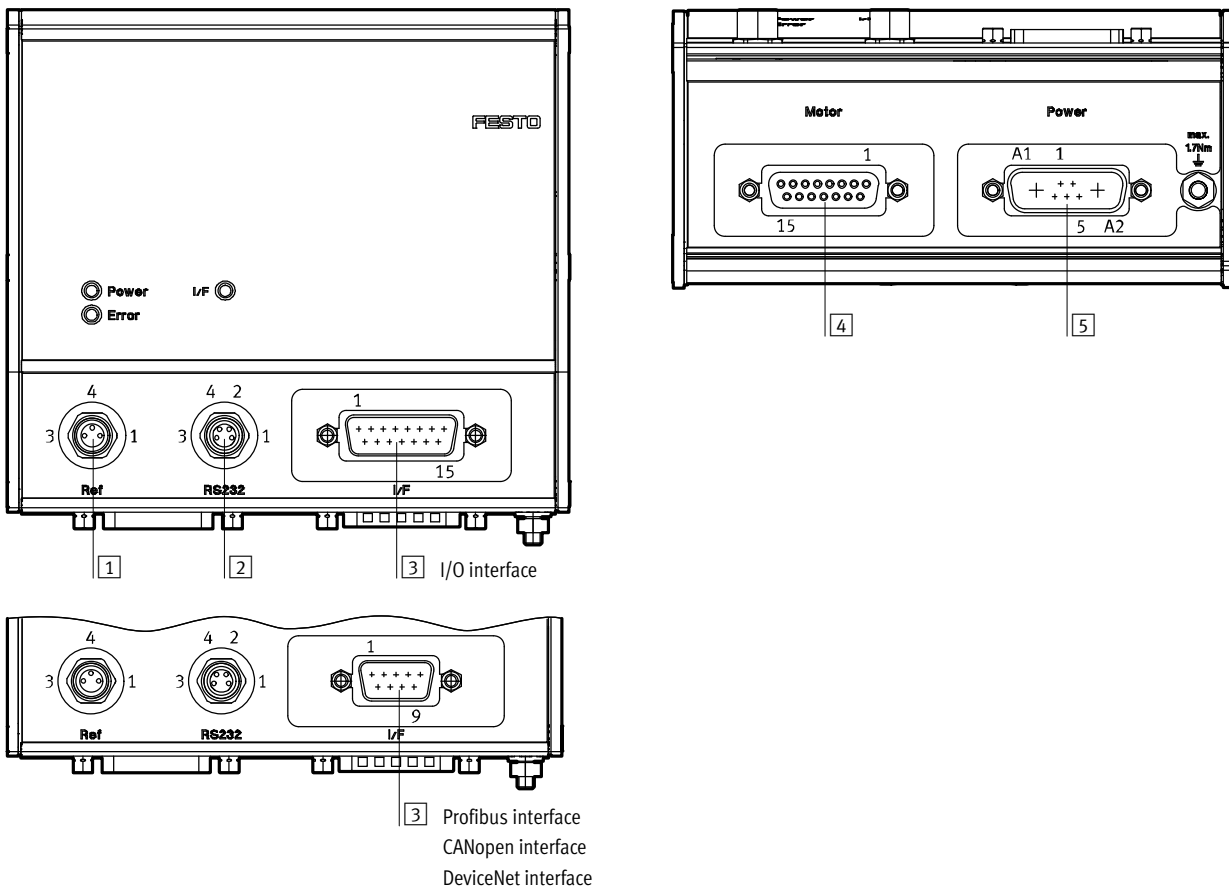

1 Reference switch, 3-pin M8 socket	
Pin	Function
1	24 V
4	Reference input
3	0 V
-	

2 RS 232 interface, 4-pin M8 socket	
Pin	Function
1	0 V
2	Transmitted Data (TxD)
3	Received Data (RxD)
4	-

Motor controllers SFC-DC

Technical data

3 I/O interface, 15-pin Sub-D plug	
Pin	Function
1	24 V (supply for output)
2	Position set coding, bit 1
3	Position set coding, bit 2
4	Position set coding, bit 3
5	Position set coding, bit 4
6	Position set coding, bit 5
7	Stop bit
8	0 V
9	Enable bit
10	Start bit
11	MC
12	Ready
13	Acknowledge
14	Error
15	0 V

3 Profibus interface, 9-pin Sub-D socket	
Pin	Function
1	–
2	–
3	RxD/TxD-P
4	CNTR-P
5	DGND
6	VP
7	–
8	RxD/TxD-N
9	–

3 CANopen interface, 9-pin Sub-D plug	
Pin	Function
1	–
2	CAN_L
3	CAN_GND
4	–
5	CAN_SHLD
6	CAN_V–
7	CAN_H
8	–
9	CAN_V+

3 DeviceNet interface, 9-pin Sub-D plug	
Pin	Function
1	–
2	CAN_L
3	CAN_GND
4	–
5	CAN_SHLD
6	CAN_V–
7	CAN_H
8	–
9	CAN_V+

4 Motor interface, 15-pin Sub-D socket	
Pin	Function
1	VCC logic
2	Encoder channel A
3	Encoder channel A/
4	Encoder channel B
5	Encoder channel B/
6	Encoder channel C
7	Encoder channel C/
8	Logic 0 V
9	0 V
10	0 V
11	0 V
12	Motor +
13	Motor–
14	0 V
15	0 V

5 Power supply, 7-pin plug	
Pin	Function
A1	24 V (load)
A2	0 V (load)
1	24 V (logic)
2	0 V (logic)
3	–
4	PE
5	–

Motor controllers SFC-DC

Technical data

FESTO

Dimensions

Download CAD data → www.festo.com

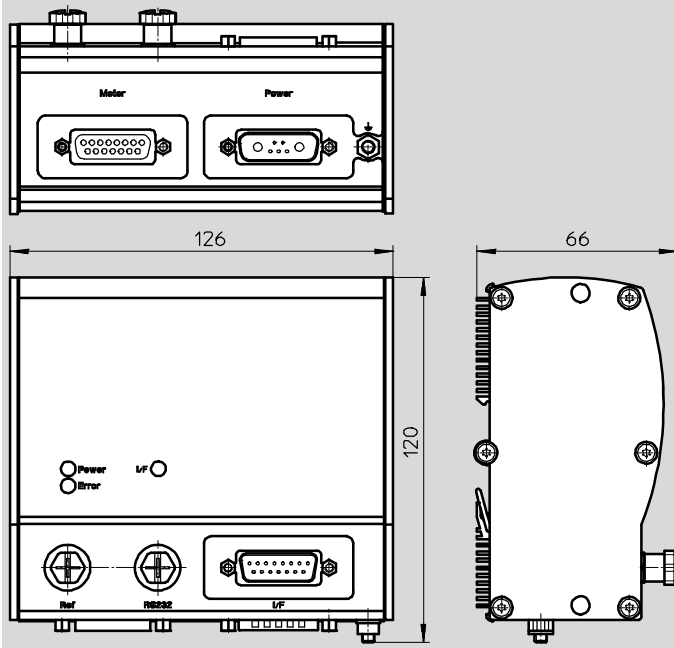

Ordering data

	Brief description	Part No.	Type
	Motor controller with I/O interface		
	Without control panel	538 912	SFC-DC-VC-3-E-H0-IO
	With control panel	538 913	SFC-DC-VC-3-E-H2-IO
	Motor controller with Profibus interface		
	Without control panel	540 366	SFC-DC-VC-3-E-H0-PB
	With control panel	540 367	SFC-DC-VC-3-E-H2-PB
	Motor controller with CANopen interface		
	Without control panel	540 364	SFC-DC-VC-3-E-H0-CO
	With control panel	540 365	SFC-DC-VC-3-E-H2-CO
	Motor controller with DeviceNet interface		
	Without control panel	540 368	SFC-DC-VC-3-E-H0-DN
	With control panel	540 369	SFC-DC-VC-3-E-H2-DN

Motor controllers SFC-DC

Accessories

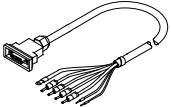
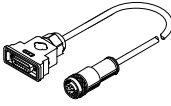
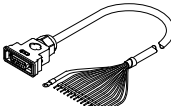
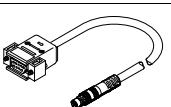
Ordering data – Cables				
	Brief description	Cable length [m]	Part No.	Type
	Supply cable, for connecting load and logic supply	2.5	538 914	KPWR-MC-1-SUB-15HC-2,5
		5	538 915	KPWR-MC-1-SUB-15HC-5
		10	538 916	KPWR-MC-1-SUB-15HC-10
	Motor cable, for connecting motor and controller	2.5	538 917	KMTR-DC-SUB-15-M12-2,5
		5	538 918	KMTR-DC-SUB-15-M12-5
		10	539 316	KMTR-DC-SUB-15-M12-10
	Control cable, for I/O interface to any controller	2.5	538 919	KES-MC-1-SUB-15-2,5
		5	538 920	KES-MC-1-SUB-15-5
		10	538 921	KES-MC-1-SUB-15-10
	Programming cable, for parameterisation and commissioning via RS232 interface using FCT software	2.5	537 926	KDI-MC-M8-SUB-9-2,5

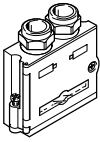
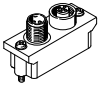
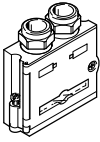
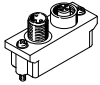
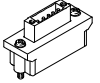
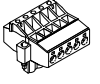
Ordering data – Plugs			
	Brief description	Part No.	Type
Plug for Profibus			
	<ul style="list-style-type: none"> – 9-pin Sub-D connection – Bus terminating resistor integrated – Position of DIL switch can be read externally – IP65 	532 216	FBS-SUB-9-GS-DP-B
Bus connection adapter for Profibus			
	<ul style="list-style-type: none"> – 9-pin Sub-D plug to 5-pin round plug/socket M12 – Bus terminating resistor must be connected externally 	533 118	FBA-2-M12-5POL-RK
Plug for CANopen and DeviceNet			
	<ul style="list-style-type: none"> – 9-pin Sub-D connection – Bus terminating resistor integrated – Position of DIL switch can be read externally – IP65 	532 219	FBS-SUB-9-BU-2x5POL-B
Bus connection adapter for CANopen and DeviceNet			
	<ul style="list-style-type: none"> – 9-pin Sub-D plug to 5-pin round plug/socket M12 – Bus terminating resistor must be connected externally 	525 632	FBA-2-M12-5POL
	<ul style="list-style-type: none"> – 9-pin Sub-D plug on 5-pin strip – Bus terminating resistor must be connected externally 	525 634	FBA-1-SL-5POL
	– 5-pin terminal strip for connecting the fieldbus cable to the bus connection adapter FBA-1-SL-5POL	525 635	FBSD-KL-2x5PIN

Motor controllers SFC-DC

Accessories

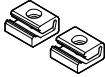

Ordering data – Central supports			
	Brief description	Part No.	Type
	Centre supports for mounting controller	160 909	MUP-8/12

Ordering data – Software			
	Brief description	Part No.	Type
	Operating package contains: – CD-ROM – with user documentation for SFC-DC, in the languages de, en, es, fr, it, sv – with configuration software FCT (Festo Configuration Tool) – Brief description This operating package is included in the scope of delivery.	550 140	P.BP-SFC-DC

Ordering data – Documentation ¹⁾					
	Language	Part No.	Type	Part No.	Type
			For I/O interface		For Profibus interface
	DE	540 417	P.BE-SFC-DC-IO-DE	540 411	P.BE-SFC-DC-PB-DE
	EN	540 418	P.BE-SFC-DC-IO-EN	540 412	P.BE-SFC-DC-PB-EN
	ES	540 419	P.BE-SFC-DC-IO-ES	540 413	P.BE-SFC-DC-PB-ES
	FR	540 420	P.BE-SFC-DC-IO-FR	540 414	P.BE-SFC-DC-PB-FR
	IT	540 421	P.BE-SFC-DC-IO-IT	540 415	P.BE-SFC-DC-PB-IT
			For CANopen interface		For DeviceNet interface
	DE	540 423	P.BE-SFC-DC-CO-DE	555 879	P.BE-SFC-DC-DN-DE
	EN	540 424	P.BE-SFC-DC-CO-EN	555 880	P.BE-SFC-DC-DN-EN
	ES	540 425	P.BE-SFC-DC-CO-ES	555 881	P.BE-SFC-DC-DN-ES
	FR	540 426	P.BE-SFC-DC-CO-FR	555 882	P.BE-SFC-DC-DN-FR
	IT	540 427	P.BE-SFC-DC-CO-IT	555 883	P.BE-SFC-DC-DN-IT

1) User documentation in paper form is not included in the scope of delivery