

Pressure sensors SDE1, with display



Pressure sensors SDE1, with display

Product range overview

Method of measurement	Operating voltage [V DC]	Measured variable	Pressure measuring range [bar]	Pneumatic connection	Type of mounting	Electrical output	
						Digital	Analogue
Piezoresistive pressure sensor with display	15 ... 30	Relative pressure Differential and relative pressure	-1 ... 0, -1 ... +1, 0 ... 2, 0 ... 6, 0 ... 10	Male thread R $\frac{1}{8}$, R $\frac{1}{4}$ Female thread G $\frac{1}{8}$ Push-in fitting for tubing O.D. 4 mm	On service unit, via H-rail, via wall/surface bracket, front panel mounting	PNP	-
						2x PNP	-
						PNP	0 ... 10 V
						PNP	4 ... 20 mA
						2x PNP	4 ... 20 mA
						NPN	-
						2x NPN	-
						NPN	0 ... 10 V
NPN	4 ... 20 mA						

Variants

- LCD display with backlighting (optimised operation)
- Illuminated LCD display (optimised reading)
- Electrical output PNP, 2x PNP, NPN, 2x NPN, 0 ... 10 V analogue, 4 ... 20 mA analogue and combinations thereof
- Electrical connection with plug M8x1 or M12x1
- Connecting cable

Pressure sensors SDE1, with display

Peripherals overview

FESTO

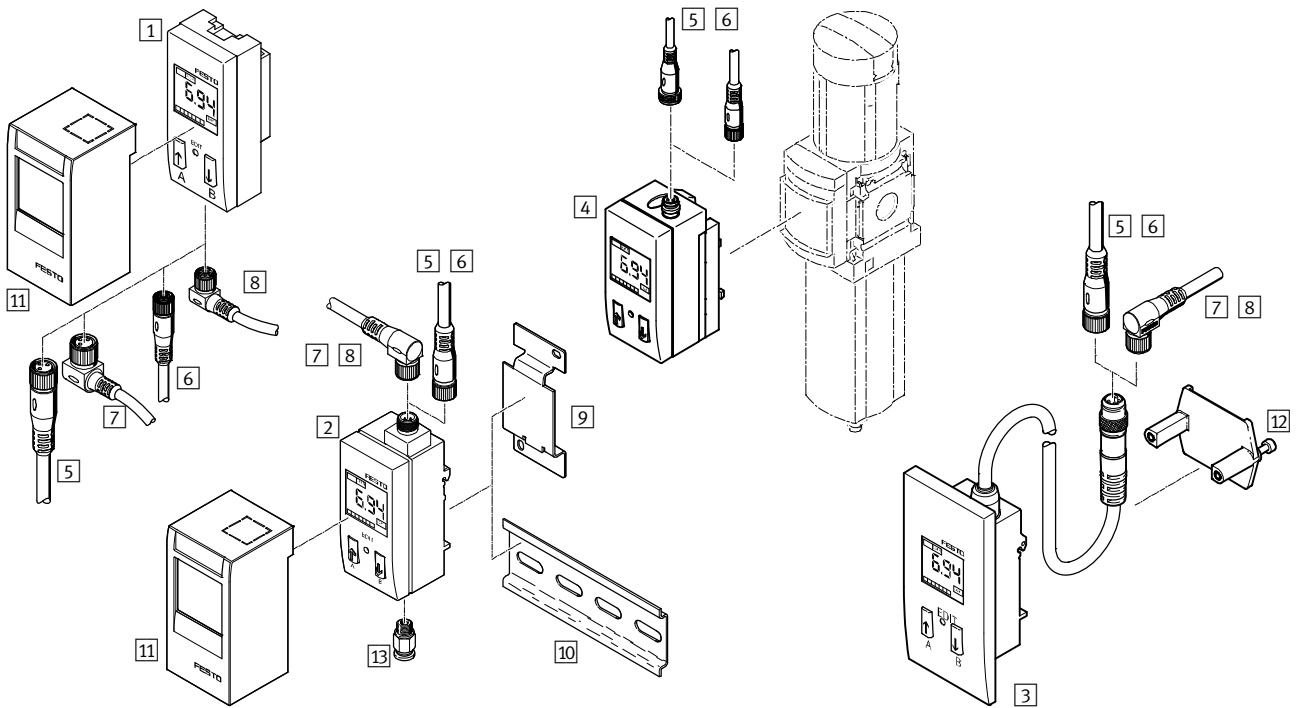

Mounting attachments and accessories	→ Page/Internet
1 Pressure sensor SDE1-...-R18, SDE1-...-R14	5
2 Pressure sensor SDE1-...-H18, SDE1-...-W18	5
3 Pressure sensor SDE1-...-FQ4	5
4 Pressure sensor SDE1-...-MS...	5
5 Connecting cable NEBU-M12G...	14
6 Connecting cable, straight socket NEBU-M8G...	14
7 Connecting cable, angled socket NEBU-M12W...	14

Mounting attachments and accessories	→ Page/Internet
8 Connecting cable NEBU-M8W... with angled socket	14
9 Adapter plate SDE1-...-W-...	14
10 Mounting rail to DIN EN 60715	nrh
11 Protective cover SDE1-SH	14
12 Clamping plate (included in the scope of delivery with SDE1-...-FQ4)	-
13 Push-in fitting QS-1/8	14

Pressure sensors SDE1, with display

Type codes

SDE1 - D10 - G2 - W18 - L - P1 - M12 - G5

Function	
SDE1	Pressure sensor with display

Pressure measuring range	
V1	-1 ... 0 bar
B2	-1 ... +1 bar
D2	0 ... 2 bar
D6	0 ... 6 bar
D10	0 ... 10 bar

Absolute accuracy	
G2	Accuracy 2%

Pneumatic connection and mounting	
Measured variable: relative pressure	
R18	Male thread R $\frac{1}{8}$, mounting on service unit
R14	Male thread R $\frac{1}{4}$, mounting on service unit
MS4	Direct connection to MS4 series service units
MS6	Direct connection to MS6 series service units
H18	Female thread G $\frac{1}{8}$, H-rail mounting
W18	Female thread G $\frac{1}{8}$, wall or surface mounting
Measured variable: differential pressure and relative pressure	
FQ4	Push-in connector QS-4, front panel mounting
HQ4	Push-in connector QS-4, DIN H-rail mounting
WQ4	Push-in connector QS-4, wall or surface mounting

Display and setting	
C	LCD display with backlighting (optimised operation)
L	Illuminated LCD display (optimised reading)

Electrical output	
P1	1 switching output PNP
P2	2 switching outputs PNP
PU	1 switching output PNP and 0 ... 10 V analogue
PI	1 switching output PNP and 4 ... 20 mA analogue
2I	2 switching outputs PNP and 4 ... 20 mA analogue
N1	1 switching output NPN
N2	2 switching outputs NPN
NU	1 switching output NPN and 0 ... 10 V analogue
NI	1 switching output NPN and 4 ... 20 mA analogue

Electrical connection	
M8	Plug M8x1
M12	Plug M12x1

Electric accessories	
Connecting cable, straight plug socket	
G	2.5 m long
G5	5 m long
Connecting cable, angled plug socket	
W	2.5 m long
W5	5 m long

Pressure sensors SDE1, with display

Technical data

Function¹⁾

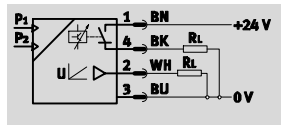

1) e.g. with 1 switching output PNP and 0 ... 10 V analogue

- - Voltage
15 ... 30 V DC

- - Pressure
-1 ... +10 bar

- - Temperature range
0 ... 50 °C



General technical data					
SDE1-...	-R...	-MS...	-H...	-W...	-F...
Certification	cULus recognized (OL) RCM trademark				-
CE mark (see declaration of conformity) ¹⁾	To EU EMC Directive				
Note on materials	Free of copper and PTFE RoHS-compliant				

1) For information about the applicability of the component see the manufacturer's EC declaration of conformity at: www.festo.com/sp → User documentation.
If the component is subject to restrictions on usage in residential, office or commercial environments or small businesses, further measures to reduce the emitted interference may be necessary.

Input signal/measuring element					
SDE1	-B2	-V1	-D2	-D6	-D10
Measured variable	Relative pressure Differential pressure ²⁾				
Method of measurement	Piezoresistive pressure sensor with display				
Operating medium	Compressed air in accordance with ISO 8573-1:2010 [7:4:4]				
Note on operating/pilot medium	Operation with lubricated medium possible (in which case lubricated operation will always be required)				
Pressure measuring range [bar]	-1 ... +1	0 ... -1	0 ... 2	0 ... 6	0 ... 10
Temperature of medium [°C]	0 ... 50				
Ambient temperature [°C]	0 ... 50				

2) Versions with push-in connector QS-4

Output, general		
Accuracy FS ³⁾	[%]	2

3) % FS = % of the measuring range (full scale)

Switching output	
Switching output	PNP NPN
Switching function	Freely programmable
Switching element function	Switchable
Reproducibility of switching value [%]	0.3
Max. output current [mA]	150

Analogue output	
Analogue output	[V] [mA]
	0 ... 10 4 ... 20

Output, additional data	
Protection against short circuit	Pulsed

Pressure sensors SDE1, with display

Technical data

Electronic components		
Operating voltage range DC	[V]	15 ... 30
Reverse polarity protection		For all electrical connections

Electromechanical components		
SDE1-...	-M8	-M12
Electrical connection	Plug M8x1, 3-pin	Plug M12x1, 3-pin
	Plug M8x1, 4-pin	Plug M12x1, 4-pin
	–	Plug M12x1, 5-pin
	Round design	
	To EN 60947-5-2	

Mechanical components	
Type of mounting	Via H-rail
	Via wall/surface bracket
	On service unit
	Front panel mounting
Pneumatic connection	R $\frac{1}{8}$
	R $\frac{1}{4}$
	G $\frac{1}{8}$
	QS-4
Housing materials	PA, POM-reinforced

- || - Note: This product conforms to ISO 1179-1 and to ISO 228-1

Display/operation	
Display type	Back illuminated LCD
	Illuminated LCD
Setting options	Teach-in
Threshold value setting range	[%] 2 ... 99.8
Hysteresis setting range	[%] 0 ... 90

Immissions/emissions	
Protection class	IP65
Corrosion resistance class CRC ⁴⁾	2

4) Corrosion resistance class 2 according to Festo standard 940 070
Components subject to moderate corrosion stress. Externally visible parts with primarily decorative surface requirements which are in direct contact with a normal industrial environment or media such as coolants or lubricating agents.

Pressure sensors SDE1, with display

Technical data

FESTO

Electrical outputs ¹⁾		Pin allocations	
1 switching output PNP			
Variant P1 with plug M8		1 = +24 V 3 = 0 V 4 = Output A	
Variant P1 with plug M12		1 = +24 V 3 = 0 V 4 = Output A	
2 switching outputs PNP			
Variant P2 with plug M8		1 = +24 V 2 = Output B 3 = 0 V 4 = Output A	
Variant P2 with plug M12		1 = +24 V 2 = Output A 3 = 0 V 4 = Output B	
1 switching output PNP and 0 ... 10 V analogue			
Variant PU with plug M8		1 = +24 V 2 = Output B (0 ... 10 V analogue) 3 = 0 V 4 = Output A	
Variant PU with plug M12		1 = +24 V 2 = Output A 3 = 0 V 4 = Output B (0 ... 10 V analogue)	
1 switching output PNP and 4 ... 20 mA analogue			
Variant PI with plug M8		1 = +24 V 2 = Output B (4 ... 20 mA analogue) 3 = 0 V 4 = Output A	
Variant PI with plug M12		1 = +24 V 2 = Output A 3 = 0 V 4 = Output B (4 ... 20 mA analogue)	
2 switching outputs PNP and 4 ... 20 mA analogue			
Variant 2I with plug M12		1 = +24 V 2 = Output B 3 = 0 V 4 = Output A 5 = Output C (4 ... 20 mA analogue)	

1) Core colours indicated apply when using connecting cable NEBU.

Pressure sensors SDE1, with display

Technical data

Electrical outputs¹⁾ 1 switching output NPN

Variant N1 with plug M8

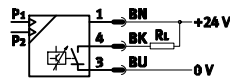

1 = +24 V
3 = 0 V
4 = Output A



Variant N1 with plug M12

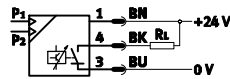

1 = +24 V
3 = 0 V
4 = Output A



2 switching outputs NPN

Variant N2 with plug M8

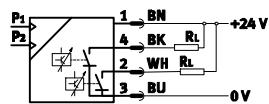

1 = +24 V
2 = Output B
3 = 0 V
4 = Output A



Variant N2 with plug M12

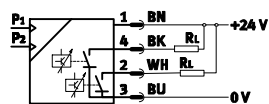

1 = +24 V
2 = Output A
3 = 0 V
4 = Output B



1 switching output NPN and 0 ... 10 V analogue

Variant NU with plug M8

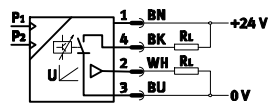

1 = +24 V
2 = Output B (0 ... 10 V analogue)
3 = 0 V
4 = Output A



Variant NU with plug M12

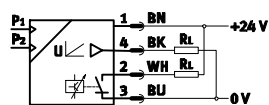

1 = +24 V
2 = Output A
3 = 0 V
4 = Output B (0 ... 10 V analogue)



1 switching output NPN and 4 ... 20 mA analogue

Variant NI with plug M8

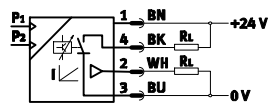

1 = +24 V
2 = Output B (4 ... 20 mA analogue)
3 = 0 V
4 = Output A



Variant NI with plug M12

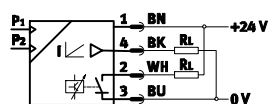

1 = +24 V
2 = Output A
3 = 0 V
4 = Output B (4 ... 20 mA analogue)



1) Core colours indicated apply when using connecting cable NEBU.

Pressure sensors SDE1, with display

Technical data

Dimensions – Mounting via male thread R $\frac{1}{8}$ or R $\frac{1}{4}$

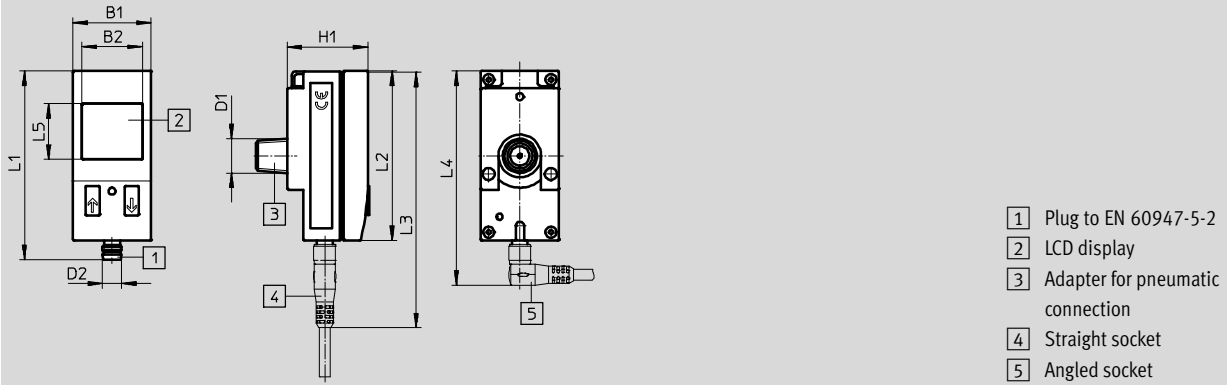

Type	B1	B2	D1	D2	H1	L1	L2	L3	L4	L5
SDE1-...-R18-M8	32.3	25	R $\frac{1}{8}$	M8	33	78	70	107	89	23
SDE1-...-R14-M8			R $\frac{1}{4}$							
SDE1-...-R18-M12	32.3	25	R $\frac{1}{8}$	M12	33	87	70	125	103	23
SDE1-...-R14-M12			R $\frac{1}{4}$							

Dimensions – Direct connection to MS4/6 series service units

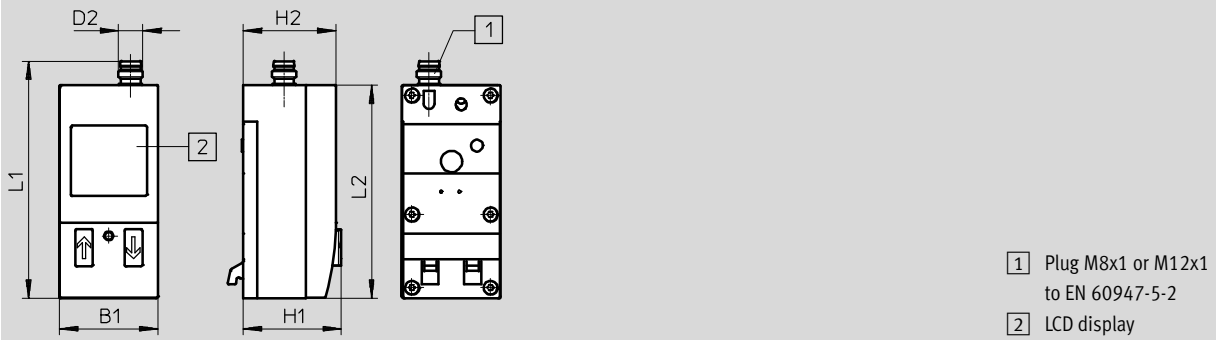

Type	B1	D2	H1	H2	L1	L2
SDE1-...-MS-...-M8	32.3	M8	32.1	30.4	78	70
SDE1-...-MS-...-M12		M12		32.3		

Pressure sensors SDE1, with display

Technical data

FESTO

Dimensions – H-rail, wall or surface mounting

Pneumatic connection G $\frac{1}{8}$

Pneumatic connection QS-4

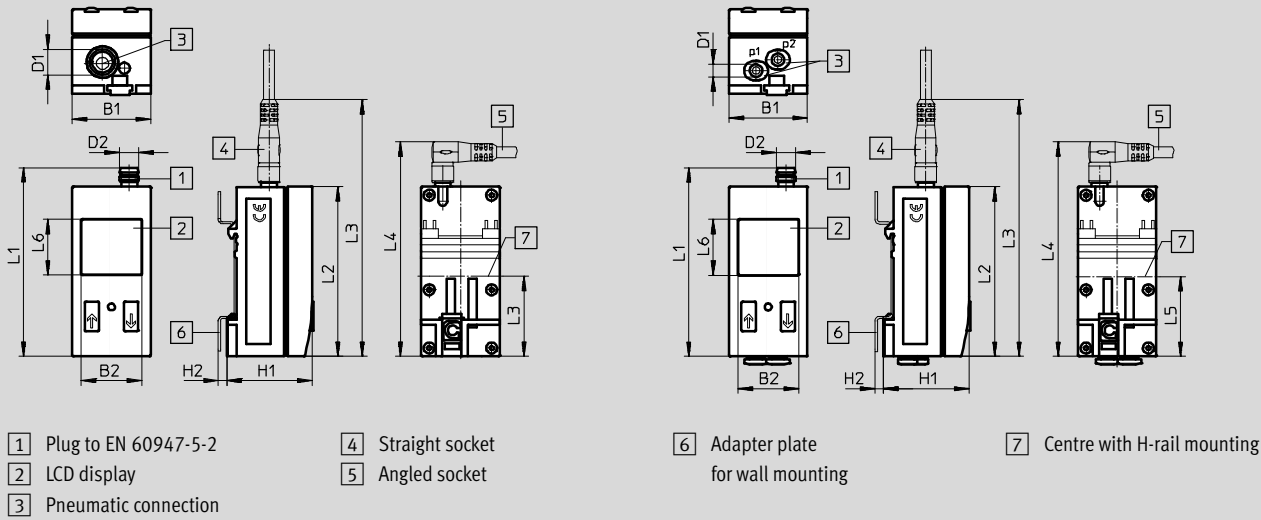

Type	B1	B2	D1	D2	H1	H2	L1	L2	L3	L4	L5	L6
SDE1-...-H18-...-M8	32.3	25	G $\frac{1}{8}$	M8	35.2	3.6	78	70	107	89	33	23
SDE1-...-W18-...-M8												
SDE1-...-H18-...-M12	32.3	25	G $\frac{1}{8}$	M12	35.2	3.6	87	70	125	103	33	23
SDE1-...-W18-...-M12												
SDE1-...-HQ4-...-M8	32.3	25	QS-4	M8	35.2	3.6	78	70	107	89	33	23
SDE1-...-WQ4-...-M8												

Dimensions – Panel mounting

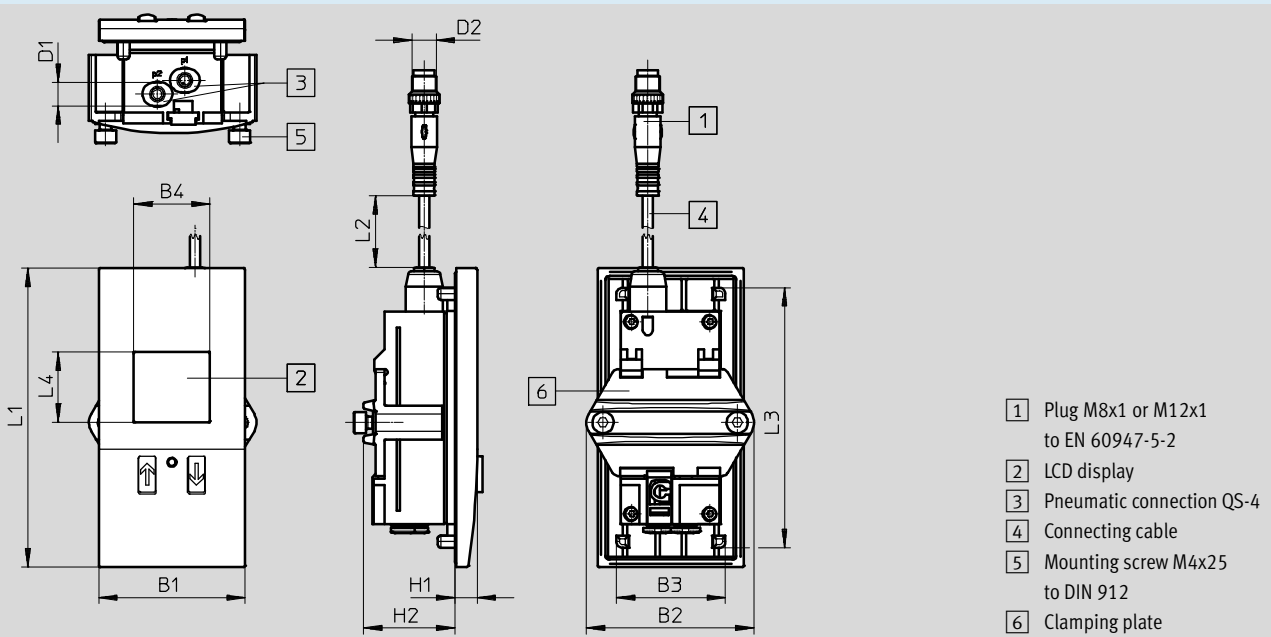

Type	B1	B2	B3	B4	D1	D2	H1	H2	L1	L2	L3	L4
SDE1-...-FQ4-M8	48	55	35.8	25	QS-4	M8x1	8	30	98	320	85.3	23
SDE1-...-FQ4-M12						M12x1						

Pressure sensors SDE1, with display

Technical data

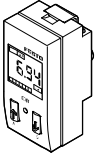
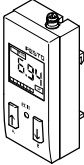
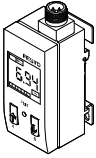
Ordering data – Measured variable: relative pressure									
Version	Pressure measuring range [bar]	Switching output	Analogue output	Electrical connection	Display type	Part No.	Type		
	Male thread R $\frac{1}{8}$, mounting on D series service unit								
	0 ... 10	PNP	–	Plug M8x1, 3-pin	LCD ¹⁾	192026	SDE1-D10-G2-R18-C-P1-M8		
					Illuminated LCD	529970	SDE1-D10-G2-R18-L-P1-M8		
				Plug M12x1, 3-pin	Illuminated LCD	534064	SDE1-D10-G2-R18-L-P1-M12		
		2x PNP	–	Plug M8x1, 4-pin	LCD ¹⁾	192027	SDE1-D10-G2-R18-C-P2-M8		
					Plug M8x1, 4-pin	LCD ¹⁾	529958	SDE1-D10-G2-R18-C-PU-M8	
						Illuminated LCD	529972	SDE1-D10-G2-R18-L-PU-M8	
	Male thread R $\frac{1}{4}$, mounting on D series service unit								
	0 ... 10	PNP	–	Plug M8x1, 3-pin	LCD ¹⁾	192028	SDE1-D10-G2-R14-C-P1-M8		
					Illuminated LCD	529967	SDE1-D10-G2-R14-L-P1-M8		
				Plug M12x1, 3-pin	Illuminated LCD	534157	SDE1-D10-G2-R14-L-P1-M12		
		2x PNP	–	Plug M8x1, 4-pin	LCD ¹⁾	192029	SDE1-D10-G2-R14-C-P2-M8		
					Plug M8x1, 4-pin	Illuminated LCD	529968	SDE1-D10-G2-R14-L-P2-M8	
						Plug M8x1, 4-pin	LCD ¹⁾	529957	SDE1-D10-G2-R14-C-PU-M8
Illuminated LCD		529969	SDE1-D10-G2-R14-L-PU-M8						
			Female thread G $\frac{1}{8}$, H-rail mounting						
0 ... -1			PNP	–	Plug M8x1, 3-pin	LCD ¹⁾	192034	SDE1-V1-G2-H18-C-P1-M8	
	Illuminated LCD					529973	SDE1-V1-G2-H18-L-P1-M8		
	2x PNP				–	Plug M8x1, 4-pin	LCD ¹⁾	192035	SDE1-V1-G2-H18-C-P2-M8
			Plug M8x1, 4-pin	Illuminated LCD			529974	SDE1-V1-G2-H18-L-P2-M8	
				Plug M8x1, 4-pin			LCD ¹⁾	529959	SDE1-V1-G2-H18-C-PU-M8
	Illuminated LCD		529975		SDE1-V1-G2-H18-L-PU-M8				
0 ... 10			PNP	–	Plug M8x1, 3-pin	LCD ¹⁾	192030	SDE1-D10-G2-H18-C-P1-M8	
	Illuminated LCD					529961	SDE1-D10-G2-H18-L-P1-M8		
	2x PNP				–	Plug M8x1, 4-pin	LCD ¹⁾	192031	SDE1-D10-G2-H18-C-P2-M8
			Plug M8x1, 4-pin	Illuminated LCD			529962	SDE1-D10-G2-H18-L-P2-M8	
				Plug M8x1, 4-pin			LCD ¹⁾	529955	SDE1-D10-G2-H18-C-PU-M8
	Illuminated LCD	529963	SDE1-D10-G2-H18-L-PU-M8						
		Female thread G $\frac{1}{8}$, for wall or surface mounting ²⁾							
	0 ... -1	PNP	–	Plug M12x1, 3-pin	Illuminated LCD	534065	SDE1-V1-G2-W18-L-P1-M12		
						4 ... 20 mA	Plug M8x1, 4-pin	537022	SDE1-V1-G2-W18-L-PI-M8
								Plug M12x1, 4-pin	537023
	0 ... 2	PNP	–	Plug M8x1, 3-pin	Illuminated LCD	537024	SDE1-D2-G2-W18-L-P1-M8		
						537025	SDE1-D2-G2-W18-L-P2-M8		
	0 ... 6	PNP	–	Plug M8x1, 3-pin	Illuminated LCD	537026	SDE1-D6-G2-W18-L-P1-M8		
						537027	SDE1-D6-G2-W18-L-P2-M8		
	0 ... 10	PNP	–	Plug M12x1, 3-pin	Illuminated LCD	534063	SDE1-D10-G2-W18-L-P1-M12		
						0 ... 10 V	Plug M8x1, 4-pin	530900	SDE1-D10-G2-W18-L-PU-M8
				2x PNP				4 ... 20 mA	Plug M12x1, 5-pin
		4 ... 20 mA	Plug M8x1, 4-pin		537020	SDE1-D10-G2-W18-L-PI-M8			
					537021	SDE1-D10-G2-W18-L-PI-M12			

1) Back illuminated

2) Adapter plate SDE1-...-W... included in the scope of delivery.

 Note
Additional variants and accessories can be configured and ordered through the SDE1 modular system → 13.

Pressure sensors SDE1, with display

Technical data

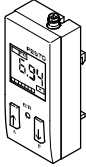
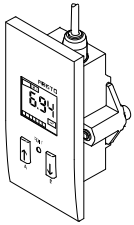
Ordering data – Measured variable: differential pressure and relative pressure						
Version	Pressure measuring range [bar]	Switching output	Analogue output	Electrical connection	Display type	Part No. Type
	Push-in connector QS-4, for H-rail mounting					
	0 ... -1	PNP	–	Plug M8x1, 3-pin	LCD ¹⁾	192036 SDE1-V1-G2-HQ4-C-P1-M8
					Illuminated LCD	529976 SDE1-V1-G2-HQ4-L-P1-M8
		2x PNP	–	Plug M8x1, 4-pin	LCD ¹⁾	192037 SDE1-V1-G2-HQ4-C-P2-M8
					Illuminated LCD	529977 SDE1-V1-G2-HQ4-L-P2-M8
	0 ... 10	PNP	–	Plug M8x1, 3-pin	LCD ¹⁾	192032 SDE1-D10-G2-HQ4-C-P1-M8
					Illuminated LCD	529964 SDE1-D10-G2-HQ4-L-P1-M8
		2x PNP	–	Plug M8x1, 4-pin	LCD ¹⁾	192033 SDE1-D10-G2-HQ4-C-P2-M8
					Illuminated LCD	529965 SDE1-D10-G2-HQ4-L-P2-M8
		PNP	0 ... 10 V	Plug M8x1, 4-pin	LCD ¹⁾	529956 SDE1-D10-G2-HQ4-C-PU-M8
	Push-in connector QS-4, for H-rail, wall or surface mounting					
	0 ... 2	2x PNP	–	Plug M8x1, 4-pin	LCD ¹⁾	535581 SDE1-D2-G2-WQ4-C-P2-M8
	Push-in connector QS-4, for front panel mounting					
	0 ... 10	PNP	–	Plug M8x1, 3-pin	Illuminated LCD	537028 SDE1-D10-G2-FQ4-L-P1-M8
				Plug M12x1, 3-pin		537030 SDE1-D10-G2-FQ4-L-P1-M12
		2x PNP	–	Plug M8x1, 4-pin	Illuminated LCD	537029 SDE1-D10-G2-FQ4-L-P2-M8
				Plug M12x1, 4-pin		537031 SDE1-D10-G2-FQ4-L-P2-M12

1) Back illuminated

 Note
 Additional variants and accessories can be configured and ordered through the SDE1 modular system
 → 13.

Pressure sensors SDE1, with display

Modular product system

FESTO

M Mandatory data								O Options
Module No.	Function	Pressure range	Absolute accuracy	Pneumatic connection and mounting	Display and setting	Electrical output	Electrical connection	Accessories: plug socket
192766	SDE1	B2, V1, D2, D6, D10	G2	R18, R14, MS4, MS6, H18, W18, HQ4, WQ4, FQ4	C, L	P1, P2, PU, PI, N1, N2, NU, NI	M8, M12	G, W, G5, W5
Ordering example								
192766	SDE1	-D6	-G2	-W18	-L	-P2	-M12	-W5

Ordering table		Condi- tions	Code	Enter code
M	Module No.	192766		192766
	Function	Pressure sensor	SDE1	SDE1
	Pressure range	Pressure range -1 ... 1 bar	-B2	
		Pressure range 0 ... -1 bar	-V1	
		Pressure range 0 ... 2 bar	-D2	
		Pressure range 0 ... 6 bar	-D6	
		Pressure range 0 ... 10 bar	-D10	
	Absolute accuracy	Accuracy 2%	-G2	-G2
	Pneumatic connection and mounting	Mounting R $\frac{1}{8}$ (service units)	-R18	
		Mounting R $\frac{1}{4}$ (service units)	-R14	
		Direct connection on MS4 series service units	-MS4	
		Direct connection on MS6 series service units	-MS6	
		Relative pressure with G $\frac{1}{8}$ connection for H-rail mounting	-H18	
		Relative pressure with G $\frac{1}{8}$ connection for wall/surface mounting	-W18	
		H-rail mounting, 4 mm push-in connector	-HQ4	
		Wall mounting, 4 mm push-in connector	-WQ4	
		Front panel mounting, 4 mm push-in connector	-FQ4	
	Display and setting	LCD display (optimised operation)	-C	
		Illuminated LCD (optimised reading)	-L	
	Electrical output	1 switch (PNP)	-P1	
		2 switches (PNP)	-P2	
		1 switch (PNP) and 0 ... 10 V analogue	-PU	
		1 switch (PNP) and 4 ... 20 mA analogue	-PI	
		1 switch (NPN)	-N1	
		2 switches (NPN)	-N2	
		1 switch (NPN) and 0 ... 10 V analogue	-NU	
		1 switch (NPN) and 4 ... 20 mA analogue	-NI	
	Electrical connection	Plug M8	-M8	
		Plug M12	-M12	
O	Accessories		-	-
	Electric accessories	Connecting cable, straight plug socket, 2.5 m	¹ G	
		Connecting cable, angled plug socket, 2.5 m	¹ W	
		Connecting cable, straight plug socket, 5 m	G5	
		Connecting cable, angled plug socket, 5 m	W5	

¹ G, W Not with electrical connection M12 in combination with electrical output P2, PU, PI, N2, NU, NI.



Transfer order code



192766 SDE1 - [] - G2 - [] - [] - [] - [] - []



Pressure sensors SDE1, with display

Accessories

FESTO

Ordering data – Connecting cables				Technical data → Internet: nebu	
	Number of wires	Cable length [m]	Part No.	Type	
M8x1, straight socket					
	3	2.5	541333	NEBU-M8G3-K-2.5-LE3	
		5	541334	NEBU-M8G3-K-5-LE3	
	4	2.5	541342	NEBU-M8G4-K-2.5-LE4	
		5	541343	NEBU-M8G4-K-5-LE4	
M8x1, angled socket					
	3	2.5	541338	NEBU-M8W3-K-2.5-LE3	
		5	541341	NEBU-M8W3-K-5-LE3	
	4	2.5	541344	NEBU-M8W4-K-2.5-LE4	
		5	541345	NEBU-M8W4-K-5-LE4	

Ordering data – Connecting cables				Technical data → Internet: nebu	
	Number of wires	Cable length [m]	Part No.	Type	
M12x1, straight socket					
	3	2.5	541363	NEBU-M12G5-K-2.5-LE3	
		5	541364	NEBU-M12G5-K-5-LE3	
	4	2.5	550326	NEBU-M12G5-K-2.5-LE4	
		5	541328	NEBU-M12G5-K-5-LE4	
	5	2.5	541330	NEBU-M12G5-K-2.5-LE5	
		5	541331	NEBU-M12G5-K-5-LE5	
M12x1, angled socket					
	3	2.5	541367	NEBU-M12W5-K-2.5-LE3	
		5	541370	NEBU-M12W5-K-5-LE3	
	4	2.5	550325	NEBU-M12W5-K-2.5-LE4	
		5	541329	NEBU-M12W5-K-5-LE4	

Ordering data – Accessories		
	Part No.	Type
Adapter plate		
	194297	SDE1-...-W-...
Protective cover		
	537074	SDE1-SH

Ordering data – Push-in fittings				Technical data → Internet: quick star	
	For tubing O.D. [mm]	Part No.	Type		
	4	186095	QS-G $\frac{1}{8}$ -4		
	6	186096	QS-G $\frac{1}{8}$ -6		
	8	186098	QS-G $\frac{1}{8}$ -8		