

Universal plug connectors, for self-assembly



Universal plug connectors, for self-assembly

Product range overview

FESTO

Function	Design	Type	Connection technology	Connection cross section [mm ²]	Protection class	Bus protocol/actuation	→ Page/Internet
Plug	Round plug connector M8						
	3-pin	NECU-S-M8G3-HX	Harax® quick connection	0.1 ... 0.14 0.14 ... 0.34	IP65, IP67	–	4
	4-pin	NECU-S-M8G4-HX	Harax® quick connection	0.14 ... 0.34	IP65, IP67	–	6
		NECU-S-M8G4-C2	Screw terminal	0.14 ... 0.5	IP67	–	6
	Round plug connector M12, A-coded						
	3-pin	NECU-S-M12G3-HX	Harax® quick connection	0.14 ... 0.34 0.34 ... 0.75	IP65, IP67	–	8
	4-pin	NECU-M-S-A12G4	Spring-loaded terminal	0.14 ... 0.5	IP65, IP67	–	10
		NECU-S-M12G4-HX	Harax® quick connection	0.14 ... 0.34 0.34 ... 0.75	IP65, IP67	–	10
		NECU-S-M12G4-...-IS	Screw terminal	0.14 ... 0.5 0.75	IP65, IP67	–	10
	5-pin	NECU-M-S-B12G5	Screw terminal	0.14 ... 0.75	IP67	PROFIBUS	14
	Round plug connector M12, D-coded						
	4-pin	NECU-M-S-D12G4	Screw terminal, can be screened	0.14 ... 0.75	IP67	Ethernet	10
	Square plug connector						
	4-pin	NECU-S-ECG4	Insulation displacement connector	0.14	IP40	–	16
	7-pin	NECU-L3G7-C1	Spring-loaded terminal	0.2 ... 2.5	–	–	18
	8-pin	NECU-L3G8-C1	Spring-loaded terminal	0.2 ... 2.5	–	–	19
		NECU-L3G8-C2	Screw terminal	0.2 ... 2.5	–	–	19
	Sub-D plug connector						
	9-pin	NECU-S1W9-C2-APB	IDC terminal	0.08 ... 0.5	IP20	PROFIBUS	21

Harax® is a registered trademark of its respective trademark holder in certain countries.

Universal plug connectors, for self-assembly

Product range overview

Function	Design	Type	Connection technology	Connection cross section [mm ²]	Protection class	Bus protocol/actuation	→ Page/Internet
Socket	Round plug connector M8						
	4-pin	NECU-M8G4	Screw terminal	0.14 ... 0.5	IP67	–	23
	Round plug connector M12						
	4-pin	SIE	Screw terminal	0.25 ... 0.75	IP67	–	25
	5-pin	NECU-M-B12G5	Screw terminal	0.14 ... 0.75	IP67	–	27
	Round plug connector 7/8"						
	4-pin	NECU-G78G4	Screw terminal	Max. 1.5	IP67	–	29
	5-pin	NECU-G78G5	Screw terminal	Max. 1.5	IP67	–	31
	AIDA push-pull plug connector						
	5-pin	NECU-M-PPG5	Spring-loaded terminal	0.75 ... 2.5	IP65, IP67	–	33
	Sub-D plug connector						
	9-pin	NECU-S1W9-C2-ACO	Screw terminal, can be screened	0.14 ... 0.5	IP20	CANopen	35

Plug, M8, 3-pin

Technical data

FESTO

Plug
NECU-S-M8G3

- Plug
- 3-pin
- Can be assembled with any cable lengths



General technical data		
Type	NECU-S-M8G3-HX-Q3	NECU-S-M8G3-HX
Electrical connection	Straight plug, M8x1	
	3-pin	
	Insulation displacement connector	
Operating voltage range	[V DC]	0 ... 32
	[V AC]	0 ... 32
Surge resistance	[kV]	0.8
Acceptable current load at 40 °C	[A]	2
		4
Based on standard	EN 61076-2-104	EN 61076-2-104
	EN 61984	EN 61984
Permissible cable Ø	[mm]	2.1 ... 3.5
Permissible individual wire Ø	[mm]	≥ 0.05
Connection cross section	[mm ²]	0.1 ... 0.14
Permissible wire Ø	[mm]	0.6 ... 1
Permissible wire insulation	PP	PP
	PVC	PVC
	–	TPE-E
Connection frequency		3
Max. tightening torque of locking clip	[Nm]	0.3
Protection class		IP65
		IP67

Materials	
Housing	Polyamide
	Nickel-plated die-cast zinc
Seals	Fluoro elastomer
	Polyurethane
Pin contact	Gold-plated
Note on materials	Free of copper and PTFE
	RoHS-compliant

Operating and environmental conditions		
Ambient temperature	[°C]	–25 ... +85
Corrosion resistance class CRC ¹⁾		1
Degree of contamination		3
Certification		cULus recognized (OL)

1) Corrosion resistance class 1 according to Festo standard 940 070
Components subject to low corrosion stress. Transport and storage protection. Parts that do not have primarily decorative surface requirements, e.g. in internal areas that are not visible or behind covers.

Plug, M8, 3-pin

Technical data

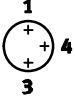
Pin allocation		
M8x1		
3-pin	Pin	Wire colour
	1	Brown
	3	Blue
	4	Black

Dimensions Download CAD data → www.festo.com

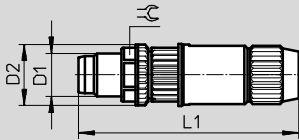

Type	D1	D2	L1	⌀
NECU-S-M8G	M8x1	11.5	40.8	9

Ordering data				
Electrical connection	Connection cross section [mm ²]	Weight [g]	Part No.	Type
Plug M8x1, 3-pin, straight, insulation displacement connector	0.1 ... 0.14	7.8	564945	NECU-S-M8G3-HX-Q3
	0.14 ... 0.34	7.8	562024	NECU-S-M8G3-HX

Plug, M8, 4-pin

Technical data

FESTO

Plug
NECU-S-M8G4

- Plug
- 4-pin
- Can be assembled with any cable lengths



General technical data		
Type	NECU-S-M8G4-HX	NECU-S-M8G4-C2
Electrical connection	Straight plug, M8x1	
	4-pin	
	Insulation displacement connector	Screw terminal
Plug coding	–	
Operating voltage range	[V DC]	0 ... 32
	[V AC]	0 ... 32
Surge resistance	[kV]	0.8
Acceptable current load at 40 °C	[A]	4
Based on standard	EN 61076-2-104	EN 61076-2-101
	EN 61984	EN 61984
Transmission characteristics	–	
Permissible cable Ø	[mm]	2.5 ... 5.1
Permissible individual wire Ø	[mm]	≥ 0.1
Connection cross section	[mm ²]	0.14 ... 0.34
Permissible wire Ø	[mm]	0.9 ... 1.6
Permissible wire insulation	PP	–
	PVC	–
	TPE-E	–
Connection frequency		3
Max. tightening torque of locking clip	[Nm]	0.3
Protection class	IP65	–
	IP67	IP67

Materials		
Type	NECU-S-M8G4-HX	NECU-S-M8G4-C2
Housing	Polyamide	–
	Nickel-plated die-cast zinc	–
Seals	Fluoro elastomer	–
	Polyurethane	–
Pin contact	Gold-plated	Gold-plated brass
Union nut	–	Nickel-plated brass
Note on materials	Free of copper and PTFE	–
	RoHS-compliant	RoHS-compliant

Plug, M8, 4-pin

Technical data

Operating and environmental conditions		
Type	NECU-S-M8G4-HX	NECU-S-M8G4-C2
Ambient temperature [°C]	-25 ... +85	-25 ... +85
Corrosion resistance class CRC ¹⁾	1	1
Degree of contamination	3	3
Certification	cULus recognized (OL)	-

1) Corrosion resistance class 1 according to Festo standard 940 070
Components subject to low corrosion stress. Transport and storage protection. Parts that do not have primarily decorative surface requirements, e.g. in internal areas that are not visible or behind covers.

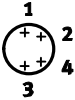
Pin allocation		
M8x1		
4-pin	Pin	Wire colour
	1	Brown
	2	White
	3	Blue
	4	Black

Dimensions Download CAD data → www.festo.com

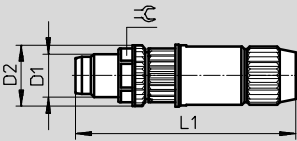

Type	D1	D2	L1	⌀
NECU-S-M8G4-HX	M8x1	11.5	40.8	9
NECU-S-M8G4-C2	M8x1	12	49.6	9

Ordering data					
Electrical connection		Connection cross section [mm ²]	Weight [g]	Part No.	Type
Plug M8x1, 4-pin, straight	Insulation displacement connector	0.14 ... 0.34	7.8	562025	NECU-S-M8G4-HX
	Screw terminal	0.14 ... 0.5	10.9	1068198	NECU-S-M8G4-C2

Plug, M12, 3-pin

Technical data

FESTO

Plug
NECU-S-M12G3

- Plug
- 3-pin
- Can be assembled with any cable lengths



General technical data			
Type	NECU-S-M12G3-HX		NECU-S-M12G3-HX-Q7
Electrical connection	Straight plug, M12x1		
	3-pin		
	Insulation displacement connector		
Plug coding	A-coded		
Operating voltage range	[V DC]	0 ... 32	0 ... 48
	[V AC]	0 ... 32	0 ... 48
Surge resistance	[kV]	0.8	0.8
Acceptable current load at 40 °C	[A]	4	6
Based on standard	EN 61076-2-101		EN 61076-2-101
	EN 61984		EN 61984
Permissible cable Ø	[mm]	2.9 ... 5.1	4.7 ... 6.0
Permissible individual wire Ø	[mm]	≥ 0.1	≥ 0.1
Connection cross section	[mm ²]	0.14 ... 0.34	0.34 ... 0.75
Permissible wire Ø	[mm]	0.9 ... 1.6	1.6 ... 2.0
Permissible wire insulation	PP		–
	PVC		PVC
	TPE-E		–
Connection frequency		3	3
Max. tightening torque of locking clip	[Nm]	0.5	0.5
Protection class	IP65		IP65
	IP67		IP67

Materials	
Housing	Polyamide
	Nickel-plated die-cast zinc
Seals	Fluoro elastomer
	Polyurethane
Pin contact	Gold-plated
Note on materials	Free of copper and PTFE
	RoHS-compliant

Plug, M12, 3-pin

Technical data

Operating and environmental conditions	
Ambient temperature [°C]	-25 ... +85
Corrosion resistance class CRC ¹⁾	1
Degree of contamination	3
Certification	cULus recognized (OL)

1) Corrosion resistance class 1 according to Festo standard 940 070
Components subject to low corrosion stress. Transport and storage protection. Parts that do not have primarily decorative surface requirements, e.g. in internal areas that are not visible or behind covers.

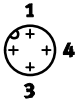
Pin allocation		
M12x1		
3-pin	Pin	Wire colour
	1	Brown
	3	Blue
	4	Black

Dimensions Download CAD data → www.festo.com

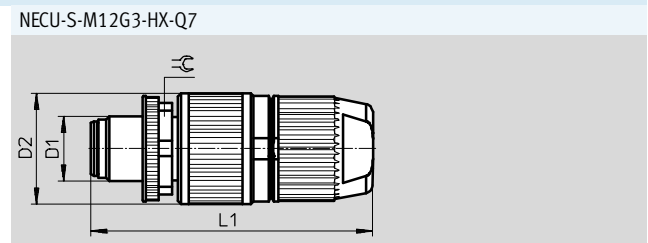
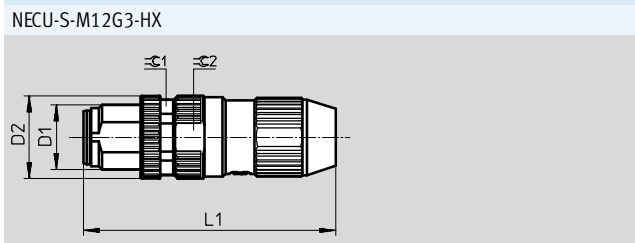

Type	D1	D2	L1	G	G1	G2
NECU-S-M12G3-HX	M12x1	15.3	46.75	-	13	14
NECU-S-M12G3-HX-Q7	M12x1	20.5	52.2	17	-	-

Ordering data						
Electrical connection		Connection cross section [mm ²]	Weight [g]	Part No.	Type	
Plug M12x1, 3-pin, straight	Insulation displacement connector	0.14 ... 0.34	17.5	562027	NECU-S-M12G3-HX	
		0.34 ... 0.75	32.8	564946	NECU-S-M12G3-HX-Q7	

Plug, M12, 4-pin

Technical data

FESTO

Plug

NECU-M-S-A12G4

NECU-S-M12G4

NECU-M-S-D12G4

- Plug
- 4-pin
- Can be assembled with any cable lengths



General technical data				
Type		NECU-M-S-A12G4-IS	NECU-S-M12G4-HX	NECU-S-M12G4-HX-Q7
Electrical connection		Straight plug, M12x1		
		4-pin		
		Spring-loaded terminal	Insulation displacement connector	
Plug coding		A-coded	A-coded	
Operating voltage range	[V DC]	0 ... 30	0 ... 32	0 ... 48
	[V AC]	–	0 ... 32	0 ... 48
Surge resistance	[kV]	–	0.8	0.8
Acceptable current load at 40 °C	[A]	4	4	6
Based on standard		EN 61076-2-101	EN 61076-2-101	EN 61076-2-101
		–	EN 61984	EN 61984
Permissible cable Ø	[mm]	4.0 ... 8.0	2.9 ... 5.1	4.7 ... 6.0
Permissible individual wire Ø	[mm]	–	≥ 0.1	≥ 0.1
Connection cross section	[mm ²]	0.14 ... 0.5	0.14 ... 0.34	0.34 ... 0.75
Permissible wire Ø	[mm]	–	0.9 ... 1.6	1.6 ... 2.0
Permissible wire insulation		–	PP, PVC, TPE-E	PVC
Connection frequency		100	3	3
Max. tightening torque of locking clip	[Nm]	0.8	0.5	0.5
Protection class		IP65	IP65	IP65
		IP67	IP67	IP67

Materials				
Type		NECU-M-S-A12G4-IS	NECU-S-M12G4-HX	NECU-S-M12G4-HX-Q7
Housing		–	Polyamide	Polyamide
		Nickel-plated die-cast zinc	Nickel-plated die-cast zinc	Nickel-plated die-cast zinc
Seals		–	Fluoro elastomer, polyurethane	Fluoro elastomer, polyurethane
Pin contact		Gold-plated bronze	Gold-plated	Gold-plated
Note on materials		–	Free of copper and PTFE	Free of copper and PTFE
		RoHS-compliant	RoHS-compliant	RoHS-compliant

Operating and environmental conditions				
Type		NECU-M-S-A12G4-IS	NECU-S-M12G4-HX	NECU-S-M12G4-HX-Q7
Ambient temperature	[°C]	–40 ... +85	–25 ... +85	–25 ... +85
Corrosion resistance class CRC ¹⁾		–	1	1
Degree of contamination		3	3	3
Certification		–	cULus recognized (OL)	cULus recognized (OL)

1) Corrosion resistance class 1 according to Festo standard 940 070
Components subject to low corrosion stress. Transport and storage protection. Parts that do not have primarily decorative surface requirements, e.g. in internal areas that are not visible or behind covers.

Plug, M12, 4-pin

Technical data

FESTO

General technical data						
Type	NECU-S-M12G4-P1-Q6-IS	NECU-S-M12G4-D-IS	NECU-S-M12G4-P1-IS	NECU-S-M12G4-P2-IS	NECU-M-S-D12G4-C2-ET	
Electrical connection	Straight plug, M12x1					
	4-pin					
	Screw terminal				Screw terminal, can be screened	
Plug coding	A-coded				D-coded	
Operating voltage range	[V DC]	0 ... 30				0 ... 250
	[V AC]	–				0 ... 250
Surge resistance	[kV]	2.5				2.5
Acceptable current load at 40 °C	[A]	4				–
Based on standard	EN 61076-2-101				EN 61076-2-101	
	EN 61984				EN 61984	
Transmission characteristics	–				DIN EN 50173/CAT 5	
Permissible cable Ø	[mm]	2.5 ... 2.9	2x 3.0 or 2x 5.0	4.0 ... 6.0	6.0 ... 8.0	
Connection cross section	[mm ²]	0.14 ... 0.5	0.75	0.75	0.14 ... 0.75	
Connection frequency		50				–
Max. tightening torque of locking clip	[Nm]	0.5				–
Protection class	IP65				–	
	IP67				IP67	

Materials		
Type	NECU-S-M12G4-...-IS	NECU-M-S-D12G4-C2-ET
Housing	Polyamide	Nickel-plated die-cast zinc
Pin contact	Brass	Gold-plated brass
	Coated white bronze	–
Note on materials	–	Free of copper and PTFE
	RoHS-compliant	RoHS-compliant

Operating and environmental conditions			
Type	NECU-S-M12G4-...-IS	NECU-M-S-D12G4-C2-ET	
Ambient temperature	[°C]	–25 ... +85	–25 ... +85
Corrosion resistance class CRC ¹⁾		–	1
Degree of contamination		3	3
CE marking (see declaration of conformity)		–	To EU Low Voltage Directive

- 1) Corrosion resistance class 1 according to Festo standard 940 070
Components subject to low corrosion stress. Transport and storage protection. Parts that do not have primarily decorative surface requirements, e.g. in internal areas that are not visible or behind covers.

Plug, M12, 4-pin

Technical data

FESTO

Pin allocation			M12x1, A-coded			M12x1, D-coded			
4-pin			Pin	Wire colour	4-pin			Pin	Wire colour
			1	Brown				1	-
			2	White				2	-
			3	Blue				3	-
			4	Black				4	-

Dimensions Download CAD data → www.festo.com

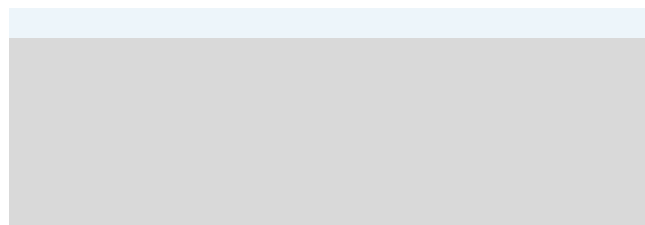
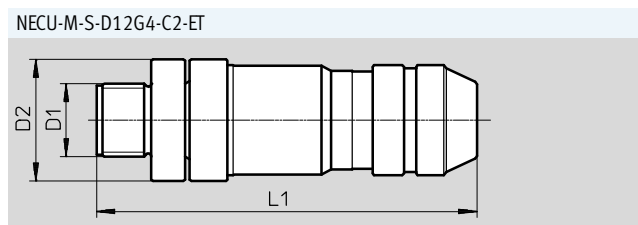
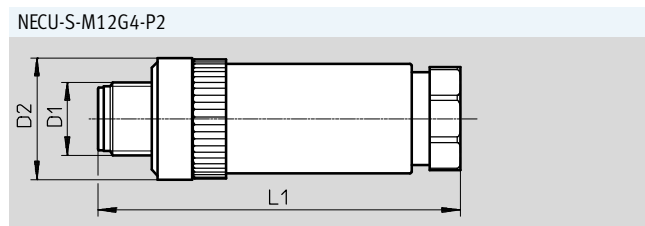
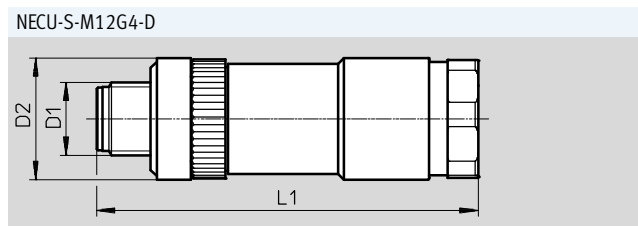
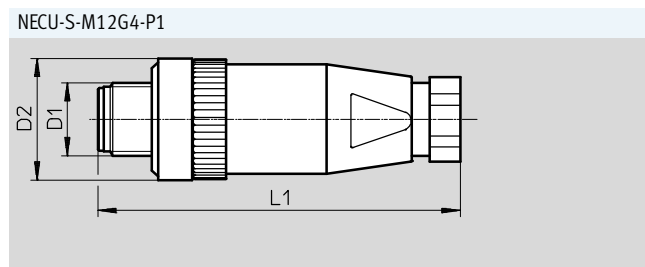
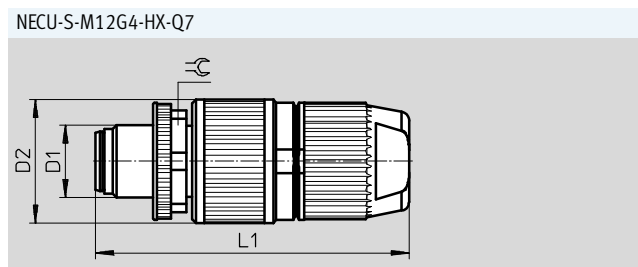
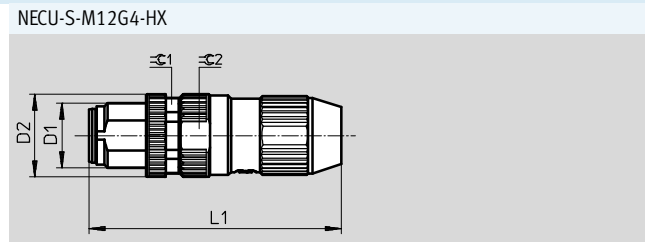
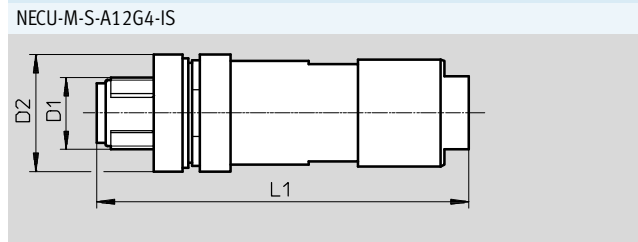

Type	D1	D2	L1	~C	~C1	~C2
NECU-M-S-A12G4-IS	M12x1	19.2	61.1	-	-	-
NECU-S-M12G4-HX	M12x1	15.3	46.75	-	13	14
NECU-S-M12G4-HX-Q7	M12x1	20.5	52.2	17	-	-
NECU-S-M12G4-P1	M12x1	20	59.6	-	-	-
NECU-S-M12G4-D	M12x1	20	62.6	-	-	-
NECU-S-M12G4-P2	M12x1	20	59.6	-	-	-
NECU-M-S-D12G4-C2-ET	M12x1	20	62.5	-	-	-

Plug, M12, 4-pin

Technical data

Ordering data					
Electrical connection		Connection cross section [mm ²]	Weight [g]	Part No.	Type
Plug M12x1, 4-pin, straight, A-coded	Spring-loaded terminal	0.14 ... 0.5	38	575719	NECU-M-S-A12G4-IS
	Insulation displacement connector	0.14 ... 0.34	17.5	562028	NECU-S-M12G4-HX
		0.34 ... 0.75	33.3	564947	NECU-S-M12G4-HX-Q7
	Screw terminal	0.14 ... 0.5	18	570955	NECU-S-M12G4-P1-Q6-IS
		0.75	24	570956	NECU-S-M12G4-D-IS
		0.75	17	570953	NECU-S-M12G4-P1-IS
		0.75	18	570954	NECU-S-M12G4-P2-IS
Plug M12x1, 4-pin, straight, D-coded	Screw terminal, can be screened	0.14 ... 0.75	45.3	543109	NECU-M-S-D12G4-C2-ET

Plug, M12, 5-pin

Technical data

FESTO

Plug
NECU-M-S-B12G5

- Plug
- 5-pin
- B-coded for PROFIBUS
- Can be assembled with any cable lengths



General technical data	
Electrical connection	Straight plug, M12x1 5-pin Screw terminal, can be screened
Plug coding	B-coded
Operating voltage range	[V DC] 0 ... 60 [V AC] 0 ... 60
Surge resistance	[kV] 1.5
Acceptable current load at 40 °C	[A] 4
Based on standard	EN 61076-2-101 EN 61984
Transmission characteristics	DIN EN 50173/CAT 5
Permissible cable Ø	[mm] 6 ... 8
Connection cross section	[mm ²] 0.14 ... 0.75
Protection class	IP67

Materials	
Housing	Nickel-plated die-cast zinc
Pin contact	Gold-plated brass
Note on materials	Free of copper and PTFE RoHS-compliant

Operating and environmental conditions	
Ambient temperature	[°C] -25 ... +85
Corrosion resistance class CRC ¹⁾	1
Degree of contamination	3
CE marking (see declaration of conformity)	To EU Low Voltage Directive

1) Corrosion resistance class 1 according to Festo standard 940 070
Components subject to low corrosion stress. Transport and storage protection. Parts that do not have primarily decorative surface requirements, e.g. in internal areas that are not visible or behind covers.

Plug, M12, 5-pin

Technical data

Dimensions

NECU-M-S-B12G5

Download CAD data → www.festo.com

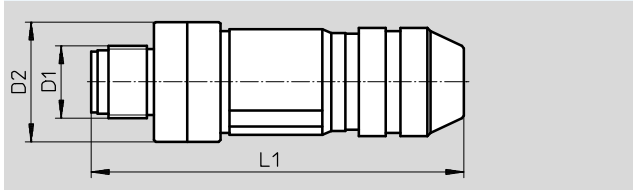

Pin allocation

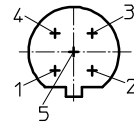

Type	D1	D2	L1
NECU-M-S-B12G5	M12	20	62.5

Ordering data

Electrical connection	Connection cross section [mm ²]	Weight [g]	Part No.	Type
Plug M12x1, 5-pin, straight	Screw terminal, can be screened 0.14 ... 0.75	46	1066354	NECU-M-S-B12G5-C2-PB

Plug, square, 4-pin

Technical data

FESTO

Plug
NECU-S-ECG4

- Plug
- 4-pin
- Insulation displacement connector
- Can be assembled with any cable lengths



General technical data		
Electrical connection		Straight plug, square design
		4-pin
		Insulation displacement connector
Operating voltage range	[V DC]	0 ... 30
Surge resistance	[kV]	0.8
Acceptable current load at 40 °C	[A]	3
Permissible individual wire Ø	[mm]	≥ 0.07
Connection cross section	[mm ²]	0.14
Permissible wire Ø	[mm]	0.8 ... 1.0
Permissible wire insulation		PP
		PVC
		TPE-E
Connection frequency		1
Type of mounting		Engaging
Protection class		IP40

Materials	
Housing	Polybutylene terephthalate
	Polycarbonate
Pin contact	Gold-plated
Note on materials	RoHS-compliant

Operating and environmental conditions	
Ambient temperature	[°C] -20 ... +60
Corrosion resistance class CRC ¹⁾	1
Degree of contamination	2
Certification	cULus recognized (OL)

1) Corrosion resistance class 1 according to Festo standard 940 070
Components subject to low corrosion stress. Transport and storage protection. Parts that do not have primarily decorative surface requirements, e.g. in internal areas that are not visible or behind covers.

Plug, square, 4-pin

Technical data

Dimensions

Download CAD data → www.festo.com

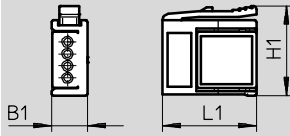

Type	B1	H1	L1
NECU-S-ECG4	5.9	14.9	15.6

Ordering data

Electrical connection		Connection cross section [mm ²]	Weight [g]	Part No.	Type
Straight plug, square design, 4-pin	Insulation displacement connector	0.14	3.6	570922	NECU-S-ECG4-HX-Q3

Plug, terminal strip, 7-pin

Technical data

FESTO

Terminal strip
NECU-L3G7

- Plug
- 7-pin
- Can be assembled with any cable lengths

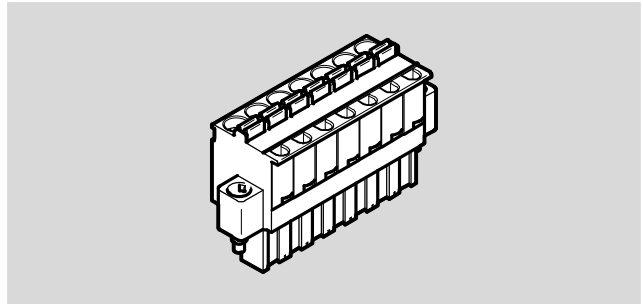

General technical data		
Electrical connection		Straight plug
		7-pin
		Spring-loaded terminal
Operating voltage range	[V DC]	0 ... 30
Surge resistance	[kV]	4
Acceptable current load at 40 °C	[A]	12
Connection cross section	[mm ²]	0.2 ... 2.5
Connection frequency		100

Materials	
Housing	Polyamide
Pin contact	Tin-plated copper alloy
Note on materials	RoHS-compliant

Operating and environmental conditions	
Ambient temperature	[°C] -40 ... +85
Corrosion resistance class CRC ¹⁾	2
Degree of contamination	3
Certification	cULus listed (OL)

1) Corrosion resistance class 2 according to Festo standard 940 070
Components subject to moderate corrosion stress. Externally visible parts with primarily decorative surface requirements which are in direct contact with a normal industrial environment or media such as coolants or lubricating agents.

Ordering data				
Electrical connection		Housing colour	Part No.	Type
Plug, 7-pin, straight	Spring-loaded terminal	Black	576319	NECU-L3G7-C1

Plug, terminal strip, 8-pin

Technical data

Terminal strip
NECU-L3G8

- Plug
- 8-pin
- Can be assembled with any cable lengths
- The plugs meet the requirements of IEC 60079-11 with regard to air, leakage paths and separation distances for the maximum intrinsically safe operating voltage of 30 V DC

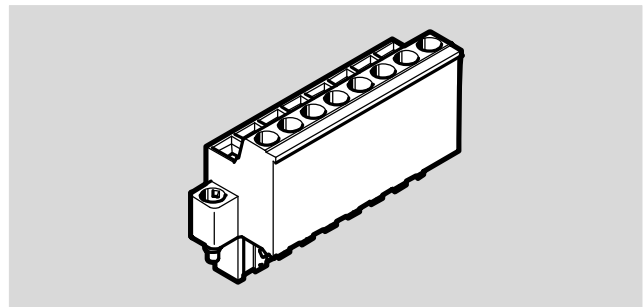

General technical data			
Type	NECU-L3G8-C1		NECU-L3G8-C2
Electrical connection	Straight plug		
	8-pin		
	Spring-loaded terminal		Screw terminal
Operating voltage range	[V DC]	0 ... 30	0 ... 30
Surge resistance	[kV]	4	0.8
Acceptable current load at 40 °C	[A]	12	12
Connection cross section	[mm ²]	0.2 ... 2.5	0.2 ... 2.5
Connection frequency		100	100
Max. tightening torque of locking clip	[Nm]	–	0.6
Product weight	[g]	20	20

Materials	
Housing	Polyamide
Pin contact	Tin-plated copper alloy
Note on materials	RoHS-compliant

Operating and environmental conditions	
Ambient temperature	[°C] –40 ... +85
Corrosion resistance class CRC ¹⁾	2
Degree of contamination	3

1) Corrosion resistance class 2 according to Festo standard 940 070
Components subject to moderate corrosion stress. Externally visible parts with primarily decorative surface requirements which are in direct contact with a normal industrial environment or media such as coolants or lubricating agents.

Plug, terminal strip, 8-pin

Technical data

FESTO

Dimensions

Download CAD data → www.festo.com

NECU-L3G8-C1

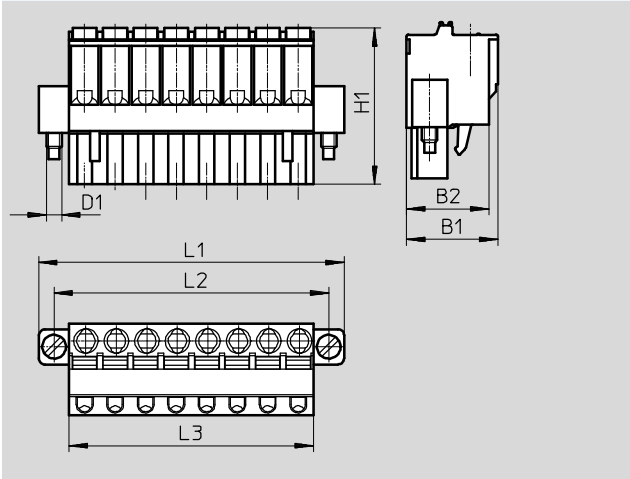

NECU-L3G8-C2

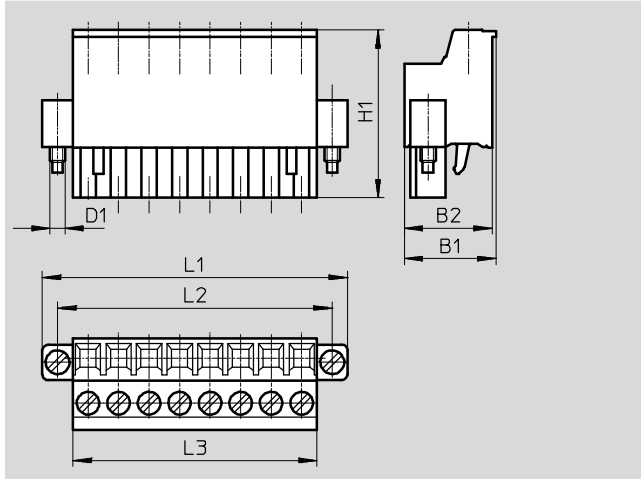

Type	B1	B2	D1	H1	L1	L2	L3
NECU-L3G8-C1	15	13.5	M2.5	25.6	50	45	40
NECU-L3G8-C2	15	14.4	M2.5	27.5	50	45	40

Ordering data

Electrical connection	Housing colour	Part No.	Type
Plug, 8-pin, straight	Spring-loaded terminal	Black	565712 NECU-L3G8-C1
		Gentian blue	565711 NECU-L3G8-C1-IS
	Screw terminal	Black	565710 NECU-L3G8-C2
		Gentian blue	565709 NECU-L3G8-C2-IS

Plug, Sub-D, 9-pin

Technical data

Plug
NECU-S1W9

- Plug
- 9-pin
- Can be assembled with any cable lengths
- Plug for PROFIBUS with terminating resistor and programming interface

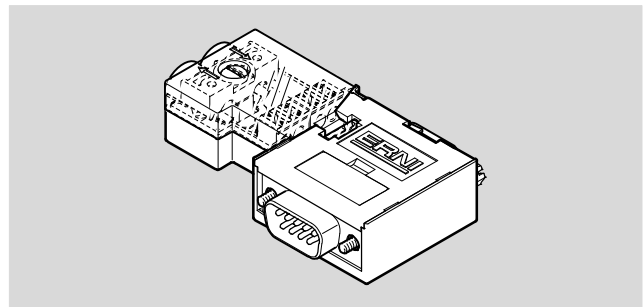

General technical data		
Electrical connection		Sub-D plug
		9-pin
		IDC terminal
Programming interface		Sub-D socket
		9-pin
Baud rate	[Mbps]	12
Permissible cable Ø	[mm]	8
Connection cross section	[mm ²]	0.08 ... 0.5
Type of mounting		4-40UNC
Protection class		IP20

Materials	
Housing	Reinforced polycarbonate
Note on materials	RoHS-compliant

Operating and environmental conditions		
Ambient temperature	[°C]	-20 ... +70
Corrosion resistance class CRC ¹⁾		1
Relative air humidity	[%]	75 at 25 °C

1) Corrosion resistance class 1 according to Festo standard 940 070
Components subject to low corrosion stress. Transport and storage protection. Parts that do not have primarily decorative surface requirements, e.g. in internal areas that are not visible or behind covers.

Plug, Sub-D, 9-pin

Technical data

FESTO

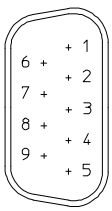
Pin allocation				
Sub-D				
9-pin	Pin	Wire colour	Signal	Terminal
Sub-D plug				
	1	-	-	-
	2	-	-	-
	3	Red	RxD/TxD-P	B
	4	-	-	-
	5	-	GND	-
	6	-	VP (supply voltage)	-
	7	-	-	-
	8	Green	RxD/TxD-N	A
	9	-	-	-
	Housing	-	-	-

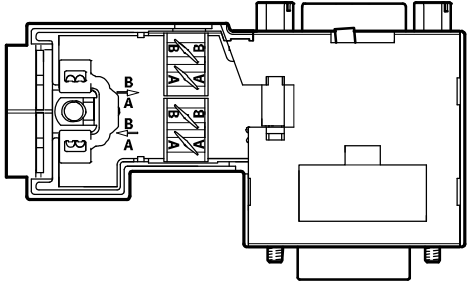

Dimensions

Download CAD data → www.festo.com

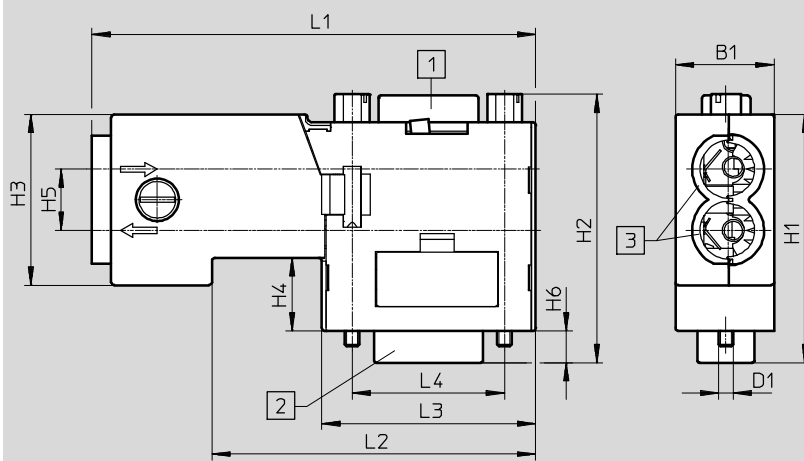

Type	B1	D1	H1	H2	H3	H4	H5	H6	L1	L2	L3	L4
NECU-S1W9-C2-APB	16.2	4-40UNC	40.7	44.2	28	12	10	5.2	72.8	53.1	35.1	25

Ordering data

Electrical connection	Connection cross section [mm]	Part No.	Type
Sub-D plug, 9-pin	IDC terminal	574589	NECU-S1W9-C2-APB

Socket, M8, 4-pin

Technical data

Socket
NECU-M8G4

- Socket
- 4-pin
- Can be assembled with any cable lengths



General technical data		
Electrical connection		Straight socket, M8x1 4-pin
Operating voltage range	[V DC]	0 ... 30
	[V AC]	0 ... 30
Surge resistance	[kV]	0.8
Acceptable current load at 40 °C	[A]	3
Based on standard		EN 61984
Permissible cable Ø	[mm]	3.5 ... 5.0
Connection cross section	[mm ²]	0.14 ... 0.5
Connection frequency		500
Max. tightening torque of locking clip	[Nm]	0.3
Protection class		IP67

Materials	
Housing	Polybutylene terephthalate
	Nickel-plated brass
Housing colour	Black
Pin contact	Gold-plated brass
Union nut	Nickel-plated brass
Note on materials	RoHS-compliant

Operating and environmental conditions		
Ambient temperature	[°C]	-40 ... +80
Storage temperature	[°C]	-40 ... +80
Corrosion resistance class CRC ¹⁾		2
Degree of contamination		3

1) Corrosion resistance class 2 according to Festo standard 940 070
Components subject to moderate corrosion stress. Externally visible parts with primarily decorative surface requirements which are in direct contact with a normal industrial environment or media such as coolants or lubricating agents.

Socket, M8, 4-pin

Technical data

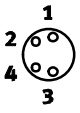
Pin allocation		
M8x1		
4-pin	Pin	Wire colour
	1	Brown
	2	White
	3	Blue
	4	Black

Dimensions Download CAD data → www.festo.com

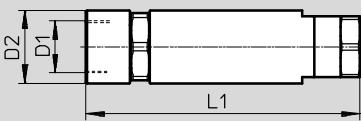

Type	D1	D2	L1
NECU-M8G	M8x1	12	45

Ordering data					
Electrical connection		Connection cross section [mm ²]	Weight [g]	Part No.	Type
Socket M8x1, 4-pin, straight	Screw terminal	0.14 ... 0.5	9.5	544392	NECU-M8G4

Socket, M12, 4-pin

Technical data

Socket

SIE-GD

SIE-WD-TR

- Socket
- 4-pin
- Can be assembled with any cable lengths



General technical data		
Type	SIE-GD	SIE-WD-TR
Electrical connection	Straight socket, M12x1 4-pin	Angled socket, M12x1 4-pin
Operating voltage range	[V DC]	0 ... 250
	[V AC]	0 ... 250
Surge resistance	[kV]	2.5
Acceptable current load at 40 °C	[A]	4
Based on standard	EN 61076-2-101	EN 61076-2-101
	EN 61984	EN 61984
Permissible cable Ø	[mm]	4 ... 6
Connection cross section	[mm ²]	0.25 ... 0.75
Max. tightening torque of locking clip	[Nm]	0.5
Protection class	IP67	IP67

Materials	
Housing	Polyamide
Union nut	Polyamide
Note on materials	RoHS-compliant

Operating and environmental conditions		
Ambient temperature	[°C]	-25 ... +85
Corrosion resistance class CRC ¹⁾		4
Degree of contamination		3
CE marking (see declaration of conformity)		To EU Low Voltage Directive

1) Corrosion resistance class 4 to Festo standard 940 070
Components subject to high corrosion stress. Parts used with aggressive media, e.g. in the food or chemical industry. These applications should be supported with special tests with the media if required.

Socket, M12, 4-pin

Technical data

FESTO

Dimensions

Download CAD data → www.festo.com

SIE-GD

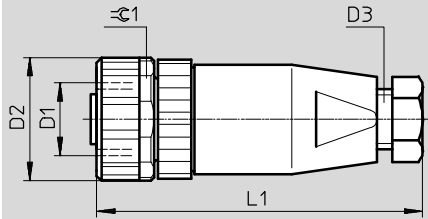

SIE-WD-TR

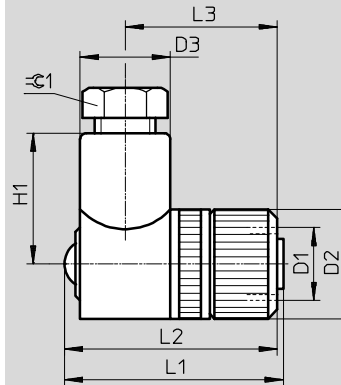

Type	D1	D2	D3	H1	L1	L2	L3	≈C1
SIE-GD	M12x1	20.2	Pg7	–	54	–	–	18
SIE-WD-TR	M12x1	18	14.8	20.5	36	35	25	13

Ordering data

Electrical connection	Connection cross section [mm ²]	Part No.	Type
Socket M12x1, 4-pin	Straight	0.25 ... 0.75	18494 SIE-GD
	Angled	0.25 ... 0.75	12956 SIE-WD-TR

Socket, M12, 5-pin

Technical data

FESTO

Socket
NECU-M-B12G5

- Socket
- 5-pin
- Can be assembled with any cable lengths



General technical data	
Electrical connection	Straight socket, M12x1 5-pin Screw terminal, can be screened
Plug coding	B-coded
Operating voltage range	[V DC] 0 ... 125 [V AC] 0 ... 125
Surge resistance	[kV] 1.25
Acceptable current load at 40 °C	[A] 4
Based on standard	EN 61076-2-101 EN 61984
Transmission characteristics	DIN EN 50173/CAT 5
Permissible cable Ø	[mm] 6 ... 8
Connection cross section	[mm ²] 0.14 ... 0.75
Protection class	IP67

Materials	
Housing	Nickel-plated die-cast zinc
Pin contact	Gold-plated brass
Note on materials	RoHS-compliant

Operating and environmental conditions	
Ambient temperature	[°C] -25 ... +85
Corrosion resistance class CRC ¹⁾	1
Degree of contamination	3
CE marking (see declaration of conformity)	To EU Low Voltage Directive

1) Corrosion resistance class 1 according to Festo standard 940 070
Components subject to low corrosion stress. Transport and storage protection. Parts that do not have primarily decorative surface requirements, e.g. in internal areas that are not visible or behind covers.

Socket, M12, 5-pin

Technical data

Dimensions

NECU-M-B12G5

Download CAD data → www.festo.com

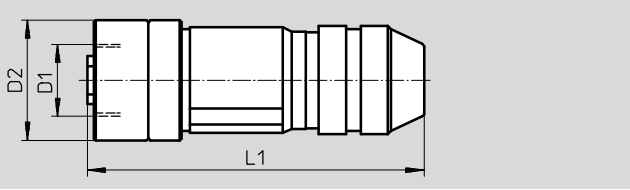

Pin allocation

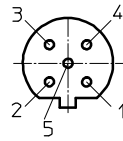

Type	D1	D2	L1
NECU-M-B12G5	M12	20	56

Ordering data

Electrical connection	Connection cross section [mm ²]	Part No.	Type
Socket M12x1, 5-pin, straight	Screw terminal	0.14 ... 0.75	1067905 NECU-M-B12G5-C2-PB

Socket, 7/8", 4-pin

Technical data

Socket
NECU-G78G4

- Socket
- 4-pin
- Can be assembled with any cable lengths



General technical data	
Electrical connection	Straight socket, 7/8" 4-pin Screw terminal
Plug coding	ODVA AutoSIG
Operating voltage range	[V DC] 0 ... 250 [V AC] 0 ... 250
Surge resistance	[kV] 2.5
Acceptable current load at 40 °C	[A] 10
Based on standard	EN 61984
Permissible cable Ø	[mm] 6 ... 12
Connection cross section	[mm ²] Max. 1.5
Protection class	IP67

Materials	
Housing	Polyamide
Housing colour	Black
Seals	Fluoro elastomer Nitrile rubber
Pin contact	Gold-plated copper alloy
Union nut	Nickel-plated die-cast zinc
Note on materials	Free of copper and PTFE RoHS-compliant

Operating and environmental conditions	
Ambient temperature	[°C] -25 ... +80
Corrosion resistance class CRC ¹⁾	1
Degree of contamination	3
CE marking (see declaration of conformity)	To EU Low Voltage Directive
Certification	c CSA us (OL)

1) Corrosion resistance class 1 according to Festo standard 940 070
Components subject to low corrosion stress. Transport and storage protection. Parts that do not have primarily decorative surface requirements, e.g. in internal areas that are not visible or behind covers.

Socket, 7/8", 4-pin

Technical data

FESTO

Dimensions

Download CAD data → www.festo.com

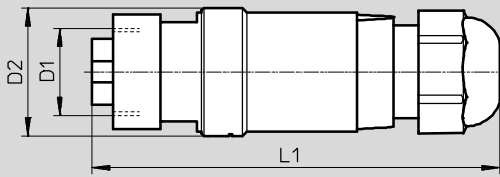

Type	D1	D2	L1
NECU-G78G4-C2	7/8"	28	89

Ordering data

Electrical connection	Connection cross section [mm ²]	Part No.	Type
Socket 7/8", 4-pin, straight	Max. 1.5	543108	NECU-G78G4-C2

Socket, 7/8", 5-pin

Technical data

Socket
NECU-G78G5

- Socket
- 5-pin
- Can be assembled with any cable lengths



General technical data	
Electrical connection	Straight socket, 7/8" 5-pin Screw terminal
Plug coding	NFPA/T3.5.29 R1-2003
Operating voltage range	[V DC] 0 ... 250 [V AC] 0 ... 250
Surge resistance	[kV] 2.5
Acceptable current load at 40 °C	[A] 8
Based on standard	EN 61984
Permissible cable Ø	[mm] 6 ... 12
Connection cross section	[mm ²] Max. 1.5
Protection class	IP67

Materials	
Housing	Polyamide
Housing colour	Black
Seals	Fluoro elastomer Nitrile rubber
Pin contact	Gold-plated copper alloy
Union nut	Nickel-plated die-cast zinc
Note on materials	Free of copper and PTFE RoHS-compliant

Operating and environmental conditions	
Ambient temperature	[°C] -25 ... +80
Corrosion resistance class CRC ¹⁾	1
Degree of contamination	3
CE marking (see declaration of conformity)	To EU Low Voltage Directive
Certification	c CSA us (OL)

1) Corrosion resistance class 1 according to Festo standard 940 070
Components subject to low corrosion stress. Transport and storage protection. Parts that do not have primarily decorative surface requirements, e.g. in internal areas that are not visible or behind covers.

Socket, 7/8", 5-pin

Technical data

FESTO

Dimensions

Download CAD data → www.festo.com

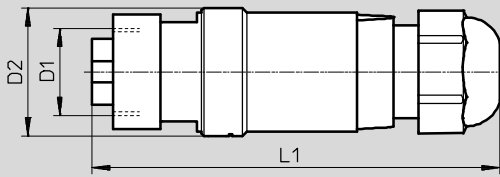

Type	D1	D2	L1
NECU-G78G5-C2	7/8"	28	89

Ordering data

Electrical connection	Connection cross section [mm ²]	Weight [g]	Part No.	Type
Socket 7/8", 5-pin, straight	Max. 1.5	10.9	543107	NECU-G78G5-C2

Socket, AIDA push-pull, 5-pin

Technical data

Plug
NECU-M-PPG5

- Socket
- 5-pin
- Can be assembled with any cable lengths



General technical data	
Electrical connection	Straight socket, AIDA push-pull 5-pin Spring-loaded terminal
Plug coding	On contact 2 and 5
Operating voltage range [V DC]	0 ... 24
Surge resistance [kV]	2.5
Acceptable current load at 40 °C [A]	16
Based on standard	EN 61984
Permissible cable Ø [mm]	9 ... 13
Connection cross section [mm ²]	0.75 ... 2.5
Protection class	IP65 IP67

Materials	
Housing	Nickel-plated die-cast zinc
Housing colour	Silver
Seals	Nitrile rubber Thermoplastic elastomer
Pin contact	Nickel-plated and gold-plated copper alloy
Note on materials	RoHS-compliant

Operating and environmental conditions	
Ambient temperature [°C]	-40 ... +100
Corrosion resistance class CRC ¹⁾	1
Degree of contamination	3

1) Corrosion resistance class CRC 1 to Festo standard FN 940070
Low corrosion stress. For dry indoor applications or transport and storage protection. Also applies to parts behind covers, in the non-visible interior area, and parts which are covered in the application (e.g. drive trunnions).

Socket, AIDA push-pull, 5-pin

Technical data

Dimensions

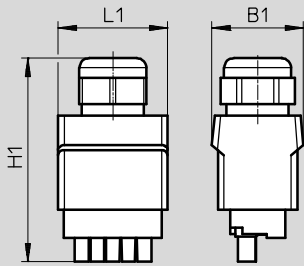

Type	B1	H1	L1
NECU-M-PPG5-C1	30	66.9	36

Ordering data

Electrical connection		Connection cross section [mm ²]	Part No.	Type
AIDA push-pull socket, 5-pin, straight	Spring-loaded terminal	0.75 ... 2.5	563059	NECU-M-PPG5-C1

Socket, Sub-D, 9-pin

Technical data

Socket
NECU-S1W9

- Socket
- 9-pin
- Can be assembled with any cable lengths
- Socket for CANopen with terminating resistor and programming interface

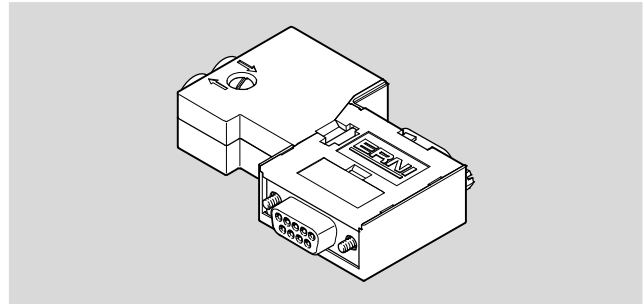

General technical data		
Electrical connection		Sub-D socket
		9-pin
		Screw terminal, can be screened
Programming interface		Sub-D plug
		9-pin
Baud rate	[Mbps]	1
Permissible cable Ø	[mm]	8
Connection cross section	[mm ²]	0.14 ... 0.5
Type of mounting		4-40UNC
Protection class		IP20

Materials	
Housing	Reinforced polycarbonate
Note on materials	RoHS-compliant

Operating and environmental conditions		
Ambient temperature	[°C]	-20 ... +70
Corrosion resistance class CRC ¹⁾		1
Relative air humidity	[%]	75 at 25 °C

1) Corrosion resistance class 1 according to Festo standard 940 070
Components subject to low corrosion stress. Transport and storage protection. Parts that do not have primarily decorative surface requirements, e.g. in internal areas that are not visible or behind covers.

Socket, Sub-D, 9-pin

Technical data

FESTO

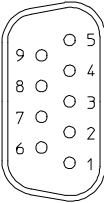
Pin allocation				
Sub-D				
9-pin	Pin	Wire colour	Signal	Terminal
Sub-D plug				
	1	–	–	–
	2	White	Received/transmitted data low	C-L
	3	Screening	0 V CAN interface	GND
	4	–	–	–
	5	–	–	–
	6	Optional	Optional screened connection	V–
	7	Brown	Received/transmitted data high	C-H
	8	–	–	–
	9	Optional	24 V DC supply CAN interface	V+
	Housing	–	–	–

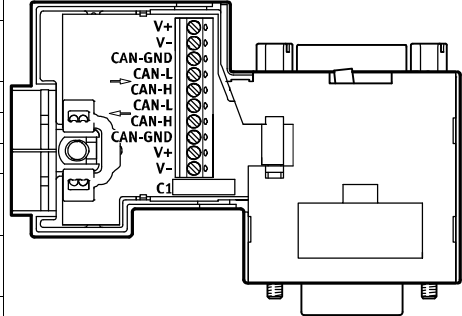

Dimensions

Download CAD data → www.festo.com

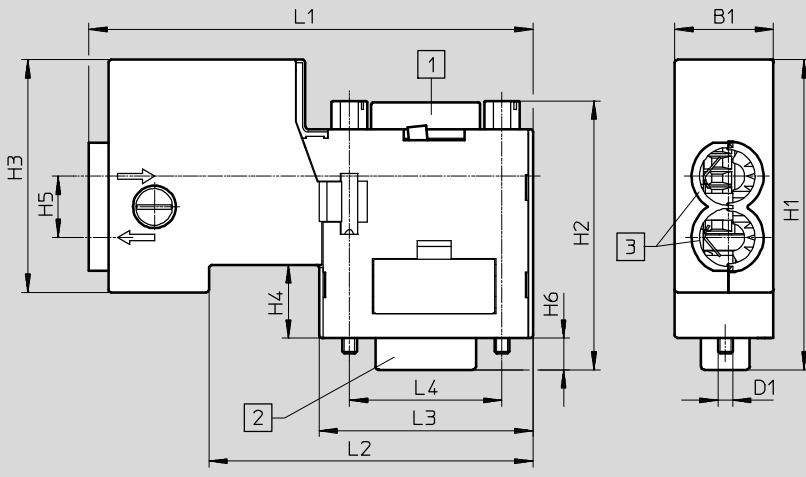

Type	B1	D1	H1	H2	H3	H4	H5	H6	L1	L2	L3	L4
NECU-S1W9-C2-ACO	16.2	4-40UNC	50.8	43.8	38.1	12	10	5.2	72.8	53.1	35.1	25

Ordering data

Electrical connection	Connection cross section [mm]	Part No.	Type
Sub-D socket, 9-pin	Screw terminal, can be screened 0.14 ... 0.5	574588	NECU-S1W9-C2-ACO

Universal plug connectors SIE, for self-assembly

Accessories

Operational status indicator SIE-LP-LED-GR

Used to indicate the ready status of a proximity sensor SIE connected via the angled socket SIE-WD-TR. It does this by illuminating a green LED.



Ordering data		Part No.	Type
Operating voltage range [V DC]	Ambient temperature [°C]		
10 ... 30	-25 ... +70	12957	SIE-LP-LED-GR