

Solenoid valves MH2/MH3/MH4, fast-switching valves

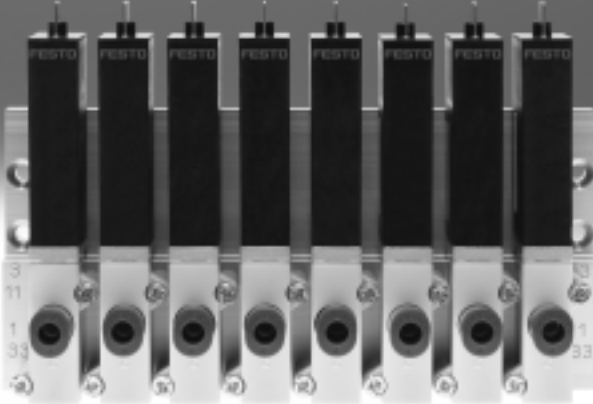

Fast-switching valves from Festo: it's not just the switching that's fast

The fast-switching professionals with response times down to 2 milliseconds

Speed, dynamic response and precision are in demand more than ever in modern automation. The solution lies in pneumatic components. The result: shorter cycle times in return for comparatively low investment costs for the components. Maximum process reliability, sturdiness and service life are guaranteed.

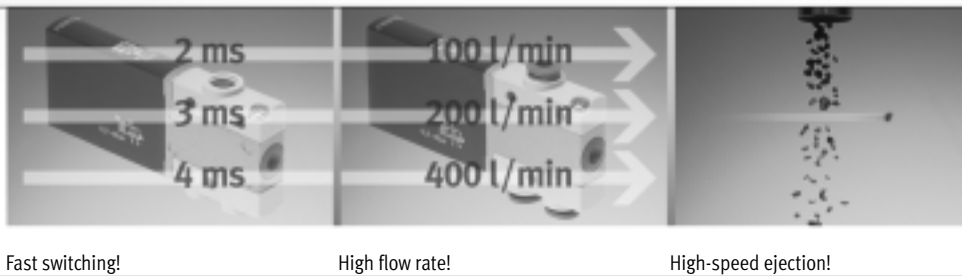

High speed in production

Fast-switching valves are a true technological gem when it comes to high-speed applications. With response times ≤ 2 ms and a repetition accuracy ≤ 0.2 ms, they represent the pinnacle of what is technologically achievable worldwide – even in 24-hour continuous operation with over 500 million cycles.

Fast-switching valves are easy to retrofit into existing systems or can be used as a pacesetter for newly designed systems. They have a compact design that provides high component density. Indispensable for sorting parts using an air ejector, in flap control systems, for gluing, dispensing, packaging and, of course, also suitable for pick & place vacuum applications, for example (continuous holding not possible).

Faster switching

The extremely short response times facilitate short cycle times. Extremely precise switching makes it possible to control the timing of process sequences accurately.

High output and very good machine utilisation are also guaranteed. Excellent repetition accuracy of response times ensures consistent processes, improves process and part quality and reduces rejects and rework.

Faster installation

Thanks to the various connection options such as threads or integrated tubing push-in connectors and the different mounting options for individual valves or manifold assembly, the installation can be optimised to suit local conditions and space requirements can be reduced to a minimum. Fast-switching valves can be used directly in the application without additional protective measures. As a result, very short pneumatic lines offer short signal paths and fast response times.

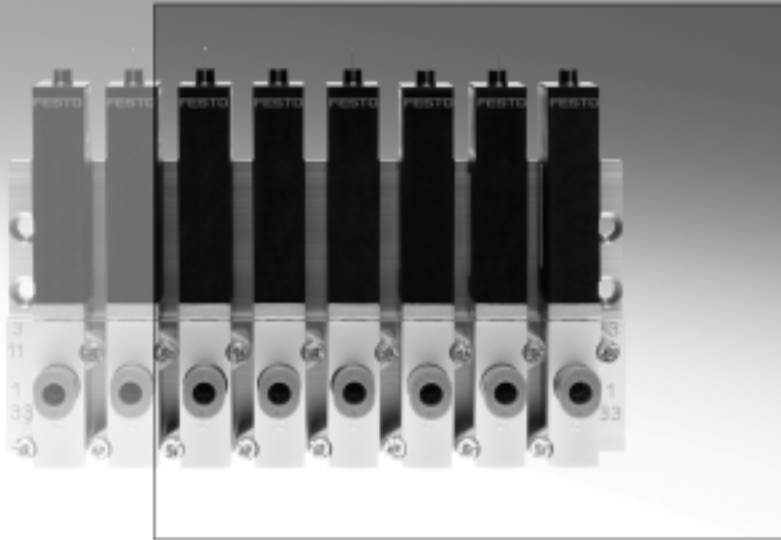

- Variants with and without fast-switching electronics as 3/2-way and 5/2-way valves
- Shortest possible response times with maximum repetition accuracy and outstanding service life
- Directly actuated poppet valve with degree of protection IP65

Advantages for designers

- Very high cycle rates
- Extremely short cycle times
- Maximum repetition accuracy
- Vacuum-compatible thanks to directly actuated poppet valve (time-restricted)
- Flexible design principle
- Direct activation via standard PLC possible
- Direct mounting in the application with degree of protection IP65

Advantages for purchasers

- Everything from a single source
- Low ordering costs
- No additional mounting components
- No costs for additional power outputs
- Use of standard PLCs
- Increased system productivity

Advantages for installation

- Easy installation
- Direct pneumatic connection via integrated tubing connections
- Reduced assembly costs with pre-assembled cables
- No additional protection required thanks to IP65



Fast and precise – sturdy and economical

High performance, process stability and extremely easy handling

MH fast-switching valves increase cycle rates and improve process and part quality with their excellent repetition accuracy.

2 ms, 100 l/min, IP 65



Accurate high-performance switching ...

... for fast and precision-pulsed operation

Integrated: the fast-switching electronics

- All 3/2- and 5/2-way valves are available with built-in fast-switching electronics
- This enables a constant dynamic response independent of temperature or supply voltage fluctuations
- With Festo plug & work, installation is easy, and no additional electronics or pneumatics know-how is necessary

Optimised: systems and processes

- On-site assembly thanks to IP65 – insensitive to dust and humidity
- Direct activation with 24 V DC/1 A – use of PLC standard outputs
- With an extremely long service life of 500 million cycles, and continuous three-shift operation with no need for maintenance, optimum efficiency comes as standard!

Key features

- Repetition accuracy ≤ 0.2 ms for accurate dispensing/bonding, for example
- Response time ≤ 3 ms for short cycle times and very quick response characteristics
- 10 mm width enables compact assembly
- Can be connected as an individual valve, semi in-line or sub-base variant, allowing for need-optimised installation
- Degree of protection IP65 enables direct mounting in the application without additional safeguarding
- Easy installation via direct activation from the standard PLC with 24 V DC/1 A

Fast valves and an optimised control chain – two guarantees for success

To generate speed in pneumatics, the combination of valve and cylinder must be perfectly harmonised. With the right combination, efficiency can be improved by 30%. Cylinders with small diameters and short strokes need fast valves.

Short-stroke cylinder ADN-32-5 – 30% faster with a fast-switching valve

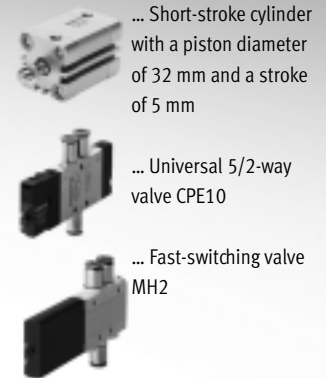
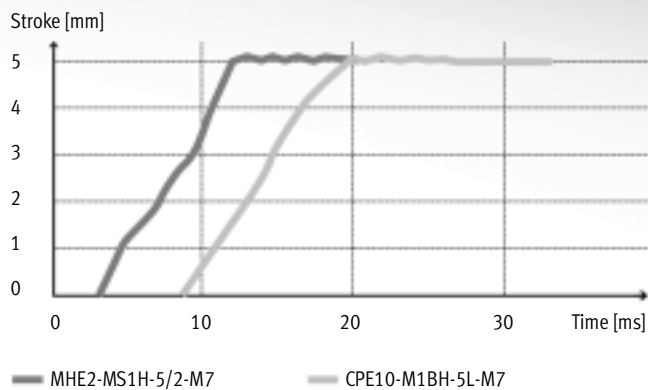

Valve type		CPE10	MH2-5/2
Flow rate	[l/min]	350	100
Valve response time	[ms]	16	1.7
Cycle time	[ms]	20	14
	[%]	100	70
Result			30% faster

Small and fast – a good combination

With a small cylinder volume, particularly in the case of short-stroke cylinders, the response time is crucial. In the example shown here, the combination with a fast-switching valve is 30% faster. In concrete terms, this means that a cylinder activated using a fast-switching valve is already in the end position before the cylinder in combination with a universal valve even begins to move.

This generates a significant increase in both the efficiency and the economy of the system – not forgetting that the two valves have comparable space requirements and weight, and the fast-switching valve uses less air and lasts 10 times as long!

Length means losses – Focus on tubing

Short tubing is a key factor when it comes to pneumatic efficiency. Reducing the tubing length from 1 m to 0.5 m, for example, improves the max. possible flow rate by 20%. A tube length greater than 2 m results in losses of up to 50%. Use of the next largest tube is recommended in this case.

Small and local – The clever alternative

Short tubing with a small diameter is ideal for mounting of valves close to the cylinder. The small and light fast-switching valves are suitable for direct mounting in the application – thanks also to their degree of protection IP65. By using them together with smaller and lighter fittings, the weight is reduced, too – resulting in an improvement in the efficiency of moving systems, in particular.

Solenoid valves MH2, fast-switching valves

Product range overview

Function	Circuit symbol	Design	Switching time [ms]				Operating voltage [V DC]	Free of copper and PTFE	→ Page/ Internet
			Off ²⁾	On ²⁾	Off	On			
3/2-way valve ¹⁾	Standard nominal flow rate 100 l/min								
		Individual valve	2	1.7	3.5	7	24	■	10
		Semi in-line valve	2	1.7	3.5	7	24	■	21
		Sub-base valve	2	1.7	3.5	7	24	■	36

- 1) Can be used as a 2/2-way valve by sealing port 3 or 33
 2) With integrated fast-switching electronics

Function	Circuit symbol	Design	Switching time [ms]		Operating voltage [V DC]	Free of copper and PTFE	→ Page/ Internet
			Off	On			
5/2-way valve	Standard nominal flow rate 100 l/min						
		Individual valve	1.7	1.9	24	■	16
		Semi in-line valve	1.7	1.9	24	■	29
Sub-base valve		1.7	1.9	24	■	44	

Mounting options							
Design	Individual valve		Semi in-line valve		Sub-base valve		
Valve function	3/2-way	5/2-way	3/2-way	5/2-way	3/2-way	5/2-way	
Plug vane							
	Direct mounting	■	■	-	-	-	-
	Individual sub-base	-	-	■	■	■	■
	Manifold assembly	-	-	■	■	■	■
Moulded-in cable							
	Direct mounting	■	■	-	-	-	-
	Individual sub-base	-	-	-	-	■	■
	Manifold assembly	-	-	-	-	■	■

Solenoid valves MH3, fast-switching valves

Product range overview

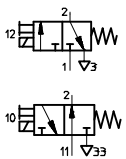
Function	Circuit symbol	Design	Switching time [ms]				Operating voltage [V DC]	Free of copper and PTFE	→ Page/ Internet
			Off ²⁾	On ²⁾	Off	On			
3/2-way valve ¹⁾	Standard nominal flow rate 200 l/min								
		Individual valve	2.8	2.3	4.5	8.3	24	■	53
		Semi in-line valve	2.8	2.3	4.5	8.3	24	■	60
Sub-base valve		2.8	2.3	4.5	8.3	24	■	68	

1) Can be used as a 2/2-way valve by sealing port 3 or 33

2) With integrated fast-switching electronics

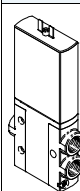
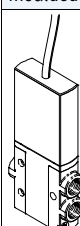
Mounting options				
Design	Individual valve	Semi in-line valve	Sub-base valve	
Plug vane				
	Direct mounting	■	-	-
	Individual sub-base	-	■	■
	Manifold assembly	-	■	■
Moulded-in cable				
	Direct mounting	■	-	-
	Individual sub-base	-	■	■
	Manifold assembly	-	■	■

Solenoid valves MH4, fast-switching valves

Product range overview

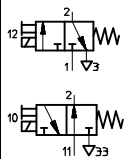
Function	Circuit symbol	Design	Switching time [ms]				Operating voltage [V DC]	Free of copper and PTFE	→ Page/ Internet
			Off ²⁾	On ²⁾	Off	On			
3/2-way valve ¹⁾	Standard nominal flow rate 400 l/min								
		Individual valve	3.5	3.5	5	10.5	24	■	78
		Semi in-line valve	3.5	3.5	5	10.5	24	■	83
Sub-base valve		3.5	3.5	5	10.5	24	■	92	

1) Can be used as a 2/2-way valve by sealing port 3 or 33

2) With integrated fast-switching electronics

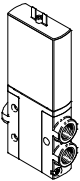
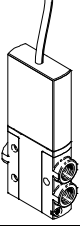
Mounting options				
Design		Individual valve	Semi in-line valve	Sub-base valve
Plug vane				
	Direct mounting	■	-	-
	Individual sub-base	-	■	■
	Manifold assembly	-	■	■
Moulded-in cable				
	Direct mounting	■	-	-
	Individual sub-base	-	■	■
	Manifold assembly	-	■	■

Solenoid valves MH2, fast-switching valves

Type codes

MH E 2 - M S 1 H - 3/2 - 0 - M7 - K

Valve series

MH	Fast-switching valves
----	-----------------------

Design

E	Individual valve
P	Semi in-line valve
A	Sub-base valve

Size

2	Flow rates 90 to 100 l/min
---	----------------------------

Drive system

M	Solenoid, switching
---	---------------------

Switching time

-	7 ms
S	2 ms

Operating voltage

1	24 V DC
---	---------

Manual override

H	Non-detenting
---	---------------

Valve function

3/2	3/2-way valve
5/2	5/2-way valve

Normal position

-	5/2-way valve
G	Closed
0	Open

Pneumatic connection

2	Sub-base, nominal width 2 mm
M5	Thread M5
M7	Thread M7
QS-4	Push-in connector For tubing O.D. 4 mm

Electrical connection

-	Plug vanes for plug socket KMYZ
K	Moulded-in cable, 2.5 m long

Solenoid valves MHE2, fast-switching valves

Peripherals overview – Individual valve, 3/2-way valve

Connection with plug vanes – Connection with moulded-in cable

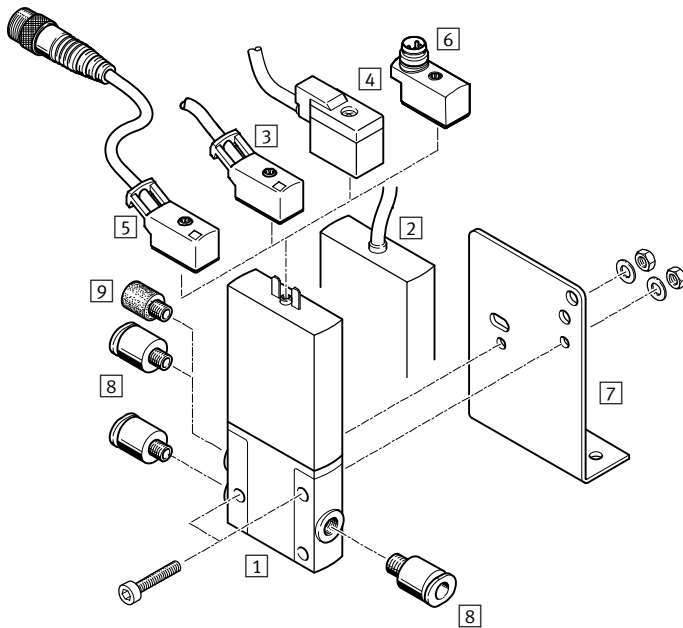

Designation	Brief description	→ Page/Internet
1 Individual valve MHE2	With plug vanes	14
2 Individual valve MHE2-...-K	With moulded-in cable, IP65	14
3 Connecting cable KMYZ-3	PUR cable, signal status display with LED, IP65	15
4 Plug socket with cable KMYZ-4	PVC cable, without signal status display, IP50	15
5 Connecting cable KMYZ-3-24-M8	PUR cable, signal status display with LED, plug M8x1 3-pin, IP65	15
6 Adapter VAVE-C8	For connecting the valves via connecting cable M8 3-pin or 4-pin, IP65	15
7 Mounting bracket MHE2-BG-L	For wall mounting	15
8 Push-in fittings QS	For connecting compressed air tubing with standard O.D.	15
9 Silencer UC	For mounting in exhaust ports	15

Solenoid valves MHE2, fast-switching valves

Technical data – Individual valve, 3/2-way valve

Function

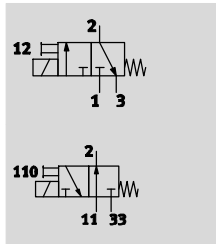

- - Voltage
24 V DC
- - Pressure
-0.9 ... +8 bar
- - Temperature range
-5 ... +60 °C



General technical data	
Valve function	3/2 way, single solenoid ¹⁾
Design	Pressure-relieved poppet valve
Sealing principle	Soft
Reset method	Mechanical spring
Actuation type	Electric
Type of control	Direct
Direction of flow	Reversible with restrictions ²⁾
Exhaust air function	With flow control
Manual override	Non-detenting
Mounting position	Any
Width	[mm] 10
Grid dimension	[mm] 14 (minimum distance 4 mm)
Nominal width	[mm] 2
Standard nominal flow rate	[l/min] 100
Type of mounting	Via through-hole
Pneumatic connection	Connecting thread M7
	Push-in connector for tubing O.D. 4 mm
Product weight	[g] 60

- 1) Can be used as a 2/2-way valve by sealing port 3 or 33
- 2) Slight leakage can occur in the pressure range -0.8 bar to +0.5 bar.

Operating and environmental conditions		With fast-switching electronics	Without fast-switching electronics
Operating medium		Compressed air to ISO 8573-1:2010 [7:4:4]	
Note on operating/pilot medium		Lubricated operation possible (in which case lubricated operation will always be required)	
Operating pressure	[bar]	-0.9 ... +8	
Ambient temperature	Normally open	-5 ... +60	
	Normally closed	-5 ... +40	
Temperature of medium	[°C]	-5 ... +60	
Restricted ambient and media temperature		As a function of switching frequency (see diagram)	
Corrosion resistance class CRC ¹⁾		2	
CE marking (see declaration of conformity)		To EU EMC Directive ²⁾	-
Certification		c UL us Recognized (OL)	c UL us Recognized (OL)
		C-Tick	-

- 1) Corrosion resistance class 2 according to Festo standard 940 070
Components subject to moderate corrosion stress. Externally visible parts with primarily decorative surface requirements which are in direct contact with a normal industrial environment or media such as coolants or lubricating agents.
- 2) For information about the applicability of the component see the manufacturer's EC declaration of conformity at: www.festo.com/sp → User documentation.
If the component is subject to restrictions on usage in residential, office or commercial environments or small businesses, further measures to reduce the emitted interference may be necessary.

Solenoid valves MHE2, fast-switching valves

Technical data – Individual valve, 3/2-way valve

Electrical data		With fast-switching electronics	Without fast-switching electronics
Electrical connection		Pug, 2-pin or moulded-in cable	
Operating voltage	[V DC]	24 ±10%	
Power consumption	[W]	5 for approx. 3 ms (high-current phase, pick-up current 1 A)	2.88
	[W]	1.25 (low-current phase)	–
Protection against incorrect polarity		Bipolar	–
Additional functions		Spark arresting	–
		Holding current reduction	–
		Protective circuit	–
Degree of protection to EN 60529	With moulded-in cable	IP65	IP65
	With connecting cable KMYZ-3	IP65	IP65
	With plug socket with cable KMYZ-4	IP50	IP50
	With adapter VAVE-C8	IP65	IP65

Response times and switching frequencies				With fast-switching electronics	Without fast-switching electronics
Switching time	On	[ms]	1.7 +10% ... -30%	7	
	Off	[ms]	2 +10% ... -30%	3.5	
Switching time variation at 1 Hz and above		[ms]	0.2	–	
Maximum switching frequency		[Hz]	330 ¹⁾	130	

1) The ambient temperature must be limited with frequencies in excess of 125 Hz.

Current curve for valves with fast-switching electronics (MHE2-MS1H)

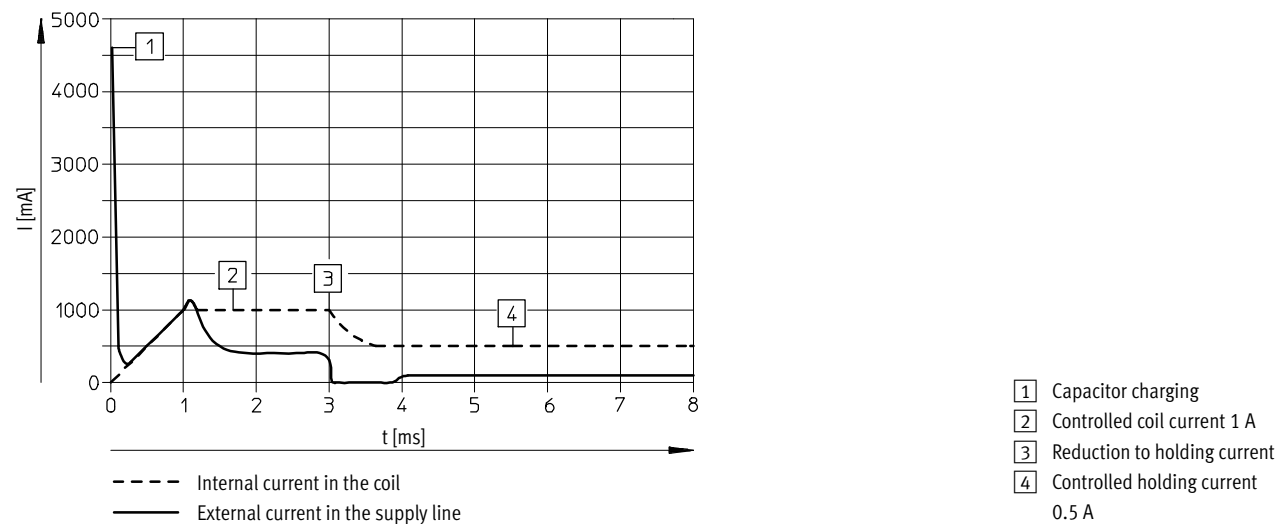

Solenoid valves MHE2, fast-switching valves

Technical data – Individual valve, 3/2-way valve

Materials

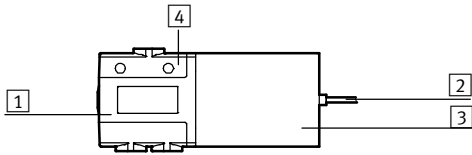

1	Housing	Die-cast zinc, coated
2	Cable sheath	PUR
3	Coil housing	PA
4	Manifold rail	PA
-	Screws	Galvanised steel
-	Seals	HNBR, NBR
Note on materials		Free of copper and PTFE RoHS-compliant ¹⁾

1) Not RoHS-compliant: MHE2-MS1H-3/2G-M7, MHE2-MS1H-3/2G-QS4, MHE2-MS1H-3/2G-M7-K, MHE2-MS1H-3/2O-QS4-K, MHE2-MS1H-3/2G-QS4-K, MHE2-M1H-3/2O-M7-K

Dimensions

Download CAD data → www.festo.com

Valve with plug vanes or moulded-in cable

MHE2-...-3/0...-M7

MHE2-...-3/0...-QS4

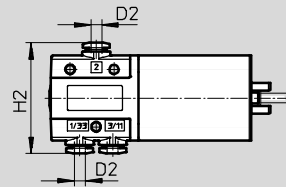
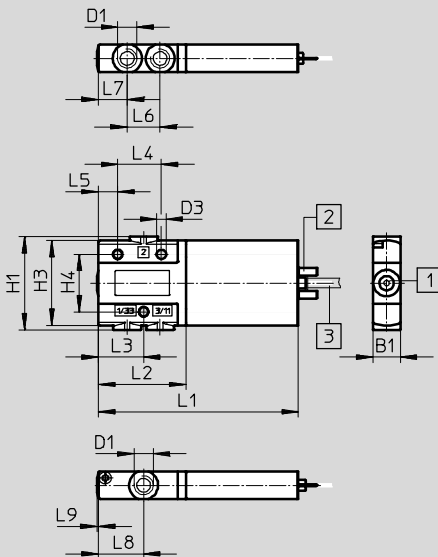

- 1 Manual override, non-detenting
- 2 Plug vanes
- 3 Cable 2.5 m

Mounting bracket MHE2-BG-L

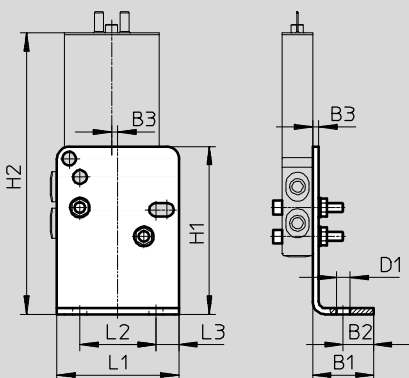

Type	B1	B2	B3	D1	D2 ∅	D3 ∅	H1	H2	H3	H4	L1	L2	L3	L4	L5	L6	L7	L8	L9
MHE2-...-3/0...-M7	10	-	-	M7	-	3.4	34	-	31	21	73	32	16.5	16	7	12	10.5	16.5	0.5
MHE2-...-3/0...-QS4	10	-	-	-	4	3.4	34	40.4	31	21	73	32	16.5	16	7	12	10.5	16.5	0.5
MHE2-BG-L	20	10	2	4.5	-	-	55	92.3	-	-	40	25	7.5	-	-	-	-	-	-

Solenoid valves MHE2, fast-switching valves



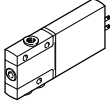
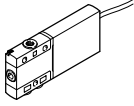

Technical data – Individual valve, 3/2-way valve

Ordering data					Part No.	Type
Valves						
	Electrical connection: plug vanes	With fast-switching electronics, switching time 2 ms	Pneumatic connection: thread M7	Normally open	196151	MHE2-MS1H-3/20-M7
				Normally closed	196131	MHE2-MS1H-3/2G-M7¹⁾
			Pneumatic connection: push-in connector for tubing O.D. 4 mm	Normally open	196155	MHE2-MS1H-3/20-QS4
				Normally closed	196135	MHE2-MS1H-3/2G-QS4¹⁾
		Without fast-switching electronics, switching time 7 ms	Pneumatic connection: thread M7	Normally open	196150	MHE2-M1H-3/20-M7
				Normally closed	196130	MHE2-M1H-3/2G-M7
			Pneumatic connection: push-in connector for tubing O.D. 4 mm	Normally open	196154	MHE2-M1H-3/20-QS4
				Normally closed	196134	MHE2-M1H-3/2G-QS4
	Electrical connection: cable	With fast-switching electronics, switching time 2 ms	Pneumatic connection: thread M7	Normally open	196153	MHE2-MS1H-3/20-M7-K
				Normally closed	196133	MHE2-MS1H-3/2G-M7-K¹⁾
			Pneumatic connection: push-in connector for tubing O.D. 4 mm	Normally open	196157	MHE2-MS1H-3/20-QS4-K¹⁾
				Normally closed	196137	MHE2-MS1H-3/2G-QS4-K¹⁾
		Without fast-switching electronics, switching time 7 ms	Pneumatic connection: thread M7	Normally open	196152	MHE2-M1H-3/20-M7-K¹⁾
				Normally closed	196132	MHE2-M1H-3/2G-M7-K
			Pneumatic connection: push-in connector for tubing O.D. 4 mm	Normally open	196156	MHE2-M1H-3/20-QS4-K
				Normally closed	196136	MHE2-M1H-3/2G-QS4-K

1) Not RoHS-compliant

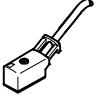
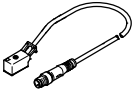
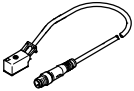
Solenoid valves MHE2, fast-switching valves

Technical data – Individual valve, 3/2-way valve

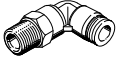
Ordering data					Part No.	Type
Connecting cable (for valves with plug vanes)						
	2-pin socket, open cable end 2-wire	PUR cable, degree of protection IP65	Signal status display with LED	2.5 m long	193693	KMYZ-3-24-2,5-LED-PUR-B
				5 m long	193695	KMYZ-3-24-5-LED-PUR-B
				10 m long	196066	KMYZ-3-24-10-LED-PUR-B
	2-pin socket, plug M8x1 3-pin	PVC cable, degree of protection IP50	Without signal status display	0.5 m long	193690	KMYZ-4-24-0,5-B
				2.5 m long	193691	KMYZ-4-24-2,5-B
	2-pin socket, plug M8x1 3-pin	PUR cable, degree of protection IP65	Signal status display with LED	0.5 m long	525654	KMYZ-3-24-M8-0,5-LED-PUR
				2.5 m long	525655	KMYZ-3-24-M8-2,5-LED-PUR
Adapter (for valves with plug vanes)						
	2-pin socket	Signal status display with LED	Plug M8, 3-pin	571686	VAVE-C8-1R8	
			Plug M8, 4-pin	573194	VAVE-C8-1R1	
Wall mounting						
	Mounting bracket				196165	MHE2-BG-L
Silencer Technical data → Internet: uc						
	Push-in sleeve with O.D. 4 mm			1 piece	165006	UC-QS-4H
	With M7 threaded connection			1 piece	161418	UC-M7
				50 pieces	534218	UC-M7-50
Push-in fitting Technical data → Internet: qs						
	Male thread M7 with internal hex for tubing O.D.	4 mm	10 pieces	153319	QSM-M7-4-I	
			100 pieces	133006	QSM-M7-4-I-100	
	Male thread M7 with external hex, push-in L-fitting rotatable through 360° for tubing O.D.	4 mm	10 pieces	153321	QSM-M7-6-I	
			100 pieces	186352	QSML-M7-4	
			100 pieces	130773	QSML-M7-4-100	
		6 mm	10 pieces	186353	QSML-M7-6	
			100 pieces	130774	QSML-M7-6-100	

Solenoid valves MHE2, fast-switching valves

Peripherals overview – Individual valve, 5/2-way valve

Connection with plug vanes – Connection with moulded-in cable

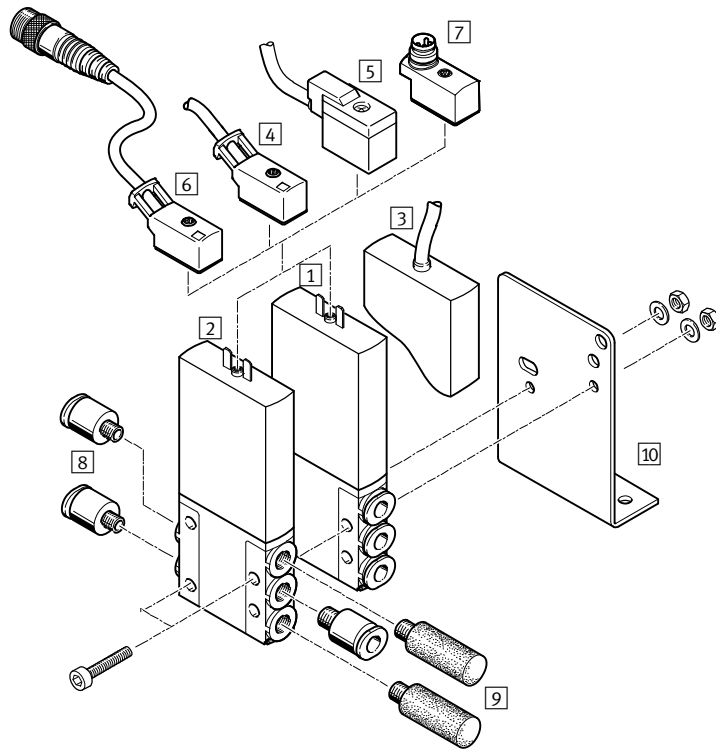

Designation	Brief description	→ Page/Internet
1 Individual valve MHE2-...QS-4	With plug vanes and connection QS-4	20
2 Individual valve MHE2-...M7	With plug vanes and connection M7	20
3 Individual valve MHE2-...K	With moulded-in cable, IP65	20
4 Connecting cable KMYZ-3	PUR cable, signal status display with LED, IP65	20
5 Plug socket with cable KMYZ-4	PVC cable, without signal status display, IP50	20
6 Connecting cable KMYZ-3-24-M8	PUR cable, signal status display with LED, plug M8x1 3-pin, IP65	20
7 Adapter VAVE-C8	For connecting the valves via connecting cable M8 3-pin or 4-pin, IP65	20
8 Push-in fittings QS	For connecting compressed air tubing with standard O.D.	20
9 Silencer UC	For installation in exhaust ports	20
10 Mounting bracket MHE2-BG-L	For wall mounting	20

Solenoid valves MHE2, fast-switching valves

Technical data – Individual valve, 5/2-way valve

Function

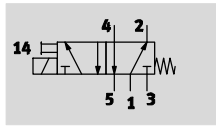

Voltage
24 V DC



Pressure
-0.9 ... +8 bar



Temperature range
-5 ... +60 °C



General technical data		
Valve function		5/2-way, single solenoid
Design		Pressure-relieved poppet valve
Sealing principle		Soft
Reset method		Mechanical spring
Actuation type		Electric
Type of control		Direct
Direction of flow		Non-reversible
Exhaust function		With flow control
Manual override		Non-detenting
Mounting position		Any
Width	[mm]	10
Grid dimension	[mm]	14
Nominal width	[mm]	2
Standard nominal flow rate	[l/min]	90
Type of mounting		Via through-hole
Pneumatic connection		Connecting thread M7
		Push-in connector for tubing O.D. 4 mm
Tightening torque for fitting	[Nm]	Max. 2
Product weight	[g]	70

Operating and environmental conditions		
Operating medium		Compressed air to ISO 8573-1:2010 [7:4:4]
Note on operating/pilot medium		Lubricated operation possible (in which case lubricated operation will always be required)
Operating pressure	[bar]	-0.9 ... +8
Ambient temperature	[°C]	-5 ... +60
Temperature of medium	[°C]	-5 ... +60
Restricted ambient and media temperature		As a function of switching frequency (see diagram)
Corrosion resistance class CRC ¹⁾		2
CE marking (see declaration of conformity)		To EU EMC Directive ²⁾
Approval certificate		cULus Recognized (OL)
		C-Tick

- 1) Corrosion resistance class 2 according to Festo standard 940 070
Components subject to moderate corrosion stress. Externally visible parts with primarily decorative surface requirements which are in direct contact with a normal industrial environment or media such as coolants or lubricating agents.
- 2) For information about the applicability of the component see the manufacturer's EC declaration of conformity at: www.festo.com/sp → User documentation.
If the component is subject to restrictions on usage in residential, office or commercial environments or small businesses, further measures to reduce the emitted interference may be necessary.

Solenoid valves MHE2, fast-switching valves

Technical data – Individual valve, 5/2-way valve

Electrical data			
Electrical connection		2-pin plug or moulded-in cable	
Operating voltage		[V DC]	24 ±10%
Power consumption	Low-current phase	[W]	1.625
	High-current phase	[W]	6.5
Protection against incorrect polarity		Bipolar	
Additional functions		Spark arresting	
		Holding current reduction	
		Protective circuit	
Degree of protection to EN 60529	With moulded-in cable	IP65	
	With connecting cable KMYZ-3	IP65	
	With plug socket with cable KMYZ-4	IP50	
	With adapter VAVE-C8	IP65	

Response times and switching frequencies			
Switching time	On	[ms]	1.9 +10% ... -30%
	Off	[ms]	1.7 +10% ... -30%
Switching time variation at 1 Hz and above		[ms]	0.2
Maximum switching frequency		[Hz]	300 ¹⁾

1) The ambient temperature must be limited with frequencies in excess of 100 Hz.

Current curve for valves with fast-switching electronics (MHE2-MS1H)

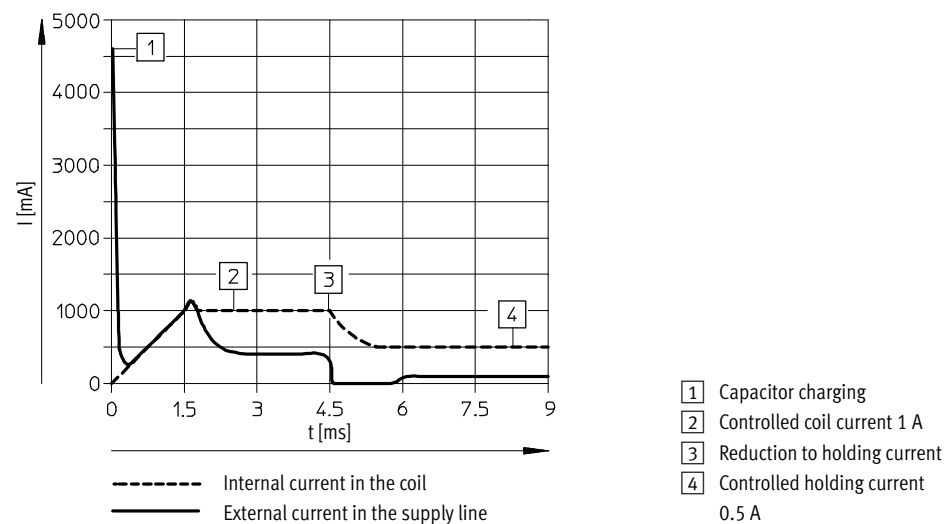

Solenoid valves MHE2, fast-switching valves

Technical data – Individual valve, 5/2-way valve

Materials

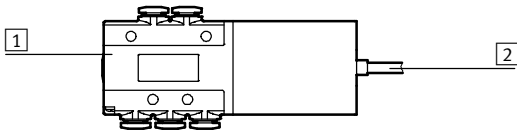

1	Housing	Die-cast zinc, coated
2	Cable sheath	PUR
-	Seals	HNBR, NBR
-	Screws	Galvanised steel
Note on materials		Free of copper and PTFE
		RoHS-compliant

Dimensions

Download CAD data → www.festo.com

Valve with plug vanes or moulded-in cable

MHE2-...-5/2-M7

MHE2-...-5/2-QS4

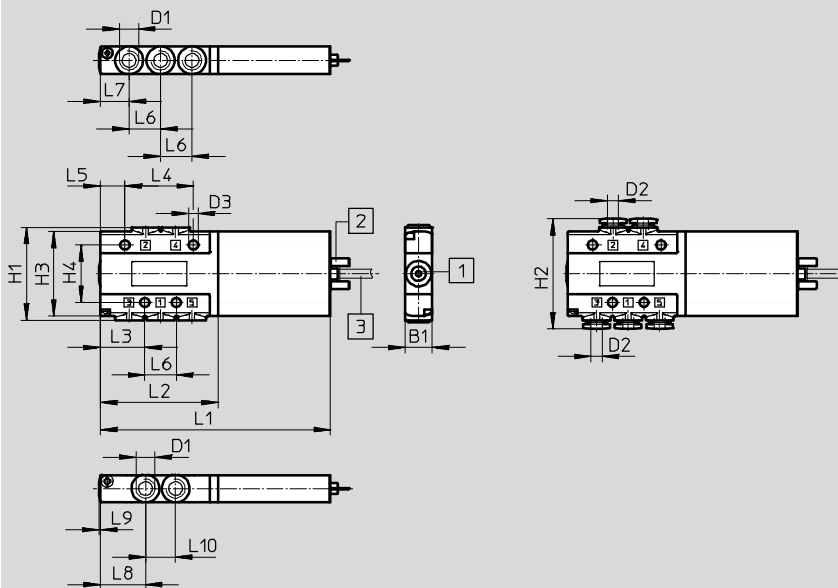

- 1 Manual override, non-detenting
- 2 Plug vanes
- 3 Cable 2.5 m

Mounting bracket MHE2-BG-L

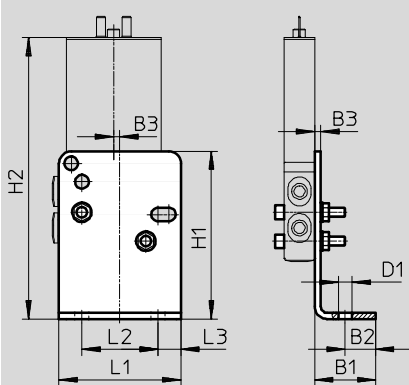





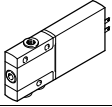
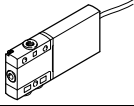
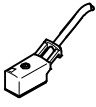
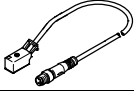

Type	B1	B2	B3	D1	D2 ∅	D3 ∅	H1	H2	H3	H4	L1	L2	L3	L4	L5	L6	L7	L8	L9	L10
MHE2-...-5/2-M7	10	-	-	M7	-	3.4	34	-	31	21	84	43	16.3	25	9	11.5	10.5	16.5	0.5	11
MHE2-...-5/2-QS4	10	-	-	-	4	3.4	34	40.4	31	21	84	43	16.3	25	9	11.5	10.5	16.5	0.5	11
MHE2-BG-L	20	10	2	4.5	-	-	55	92.3	-	-	40	25	7.5	-	-	-	-	-	-	-

Solenoid valves MHE2, fast-switching valves

FESTO

Technical data – Individual valve, 5/2-way valve

Ordering data					Part No.	Type	
Valves							
	Electrical connection: plug vanes	With fast-switching electronics, switching time 2 ms	Pneumatic connection: thread M7		525113	MHE2-MS1H-5/2-M7	
			Pneumatic connection: push-in connector for tubing O.D. 4 mm		525117	MHE2-MS1H-5/2-QS-4	
	Electrical connection: cable	With fast-switching electronics, switching time 2 ms	Pneumatic connection: thread M7		525115	MHE2-MS1H-5/2-M7-K	
			Pneumatic connection: push-in connector for tubing O.D. 4 mm		525119	MHE2-MS1H-5/2-QS-4-K	
Connecting cable (for valves with plug vanes)							
	2-pin socket, open cable end 2-wire	PUR cable, degree of protection IP65	Signal status display with LED	2.5 m long	193693	KMYZ-3-24-2,5-LED-PUR-B	
				5 m long	193695	KMYZ-3-24-5-LED-PUR-B	
				10 m long	196066	KMYZ-3-24-10-LED-PUR-B	
	2-pin socket, plug M8x1 3-pin	PVC cable, degree of protection IP50	Without signal status display	0.5 m long	193690	KMYZ-4-24-0,5-B	
				2.5 m long	193691	KMYZ-4-24-2,5-B	
				0.5 m long	525654	KMYZ-3-24-M8-0,5-LED-PUR	
				2.5 m long	525655	KMYZ-3-24-M8-2,5-LED-PUR	
Adapter (for valves with plug vanes)							
	2-pin socket	Signal status display with LED	Plug M8, 3-pin		571686	VAVE-C8-1R8	
			Plug M8, 4-pin		573194	VAVE-C8-1R1	
Wall mounting							
	Mounting bracket				196165	MHE2-BG-L	
Silencer					Technical data → Internet: uc		
	Push-in sleeve with O.D. 4 mm		1 piece	165006	UC-QS-4H		
	With M7 threaded connection		1 piece	161418	UC-M7		
			50 pieces	534218	UC-M7-50		
Push-in fitting					Technical data → Internet: qs		
	Male thread M7 with internal hex for tubing O.D.		4 mm	10 pieces	153319	QSM-M7-4-I	
				100 pieces	133006	QSM-M7-4-I-100	
			6 mm	10 pieces	153321	QSM-M7-6-I	
	Male thread M7 with external hex, push-in L-fitting rotatable through 360° for tubing O.D.		4 mm	10 pieces	186352	QSML-M7-4	
				100 pieces	130773	QSML-M7-4-100	
			6 mm	10 pieces	186353	QSML-M7-6	
				100 pieces	130774	QSML-M7-6-100	

Solenoid valves MHP2, fast-switching valves

Peripherals overview – Semi in-line valve, 3/2-way valve

Connection via plug vanes

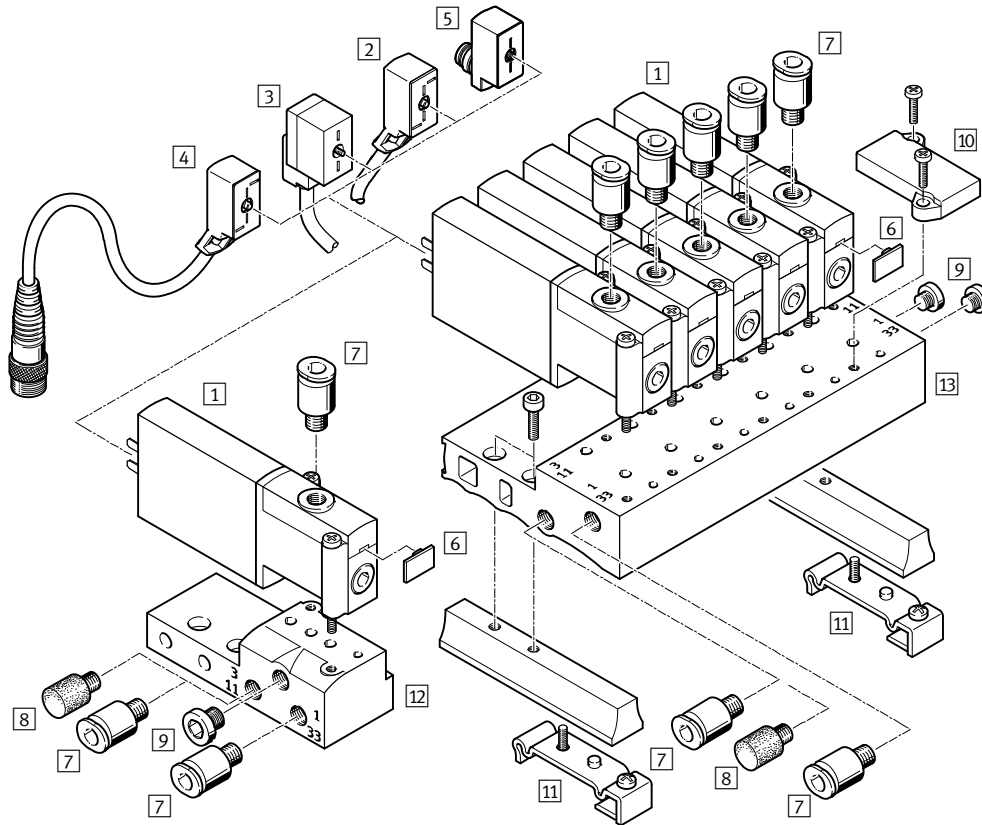

Designation	Brief description	→ Page/Internet
1 Semi in-line valve MHP2	With plug vanes	27
2 Connecting cable KMYZ-3	PUR cable, signal status display with LED, IP65	27
3 Plug socket with cable KMYZ-4	PVC cable, without signal status display, IP50	27
4 Connecting cable KMYZ-3-24-M8	PUR cable, signal status display with LED, plug M8x1 3-pin, IP65	27
5 Adapter VAVE-C8	For connecting the valves via connecting cable M8 3-pin or 4-pin, IP65	27
6 Inscription label MH-BZ-80X	For identifying the valves	28
7 Push-in fittings QS	For connecting compressed air tubing with standard O.D.	28
8 Silencer UC	For mounting in exhaust ports	28
9 Blanking plug B	For sealing unused ports	28
10 Cover plate MHAP2-BP-3	For sealing vacant positions	27
11 H-rail mounting MHAP2-BG-NRH-35	For mounting the manifold block on H-rails according to EN 60715	27
12 Individual sub-base MHA2-AS-3-M5	For semi in-line valves, the individual sub-base is also used for sub-base valves and must be sealed with a blanking plug here	27
13 Manifold block MHP2-PR...-3	For semi in-line valves	27

Solenoid valves MHP2, fast-switching valves

Technical data – Semi in-line valve, 3/2-way valve

FESTO

Function

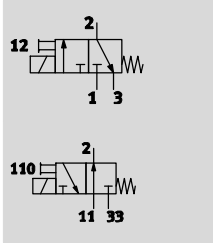

-  - Voltage
24 V DC

-  - Pressure
-0.9 ... +8 bar

-  - Temperature range
-5 ... +40 °C

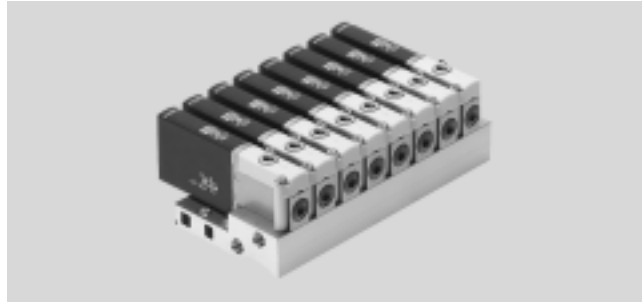

General technical data		
Valve function		3/2 way, single solenoid ¹⁾
Design		Pressure-relieved poppet valve
Sealing principle		Soft
Reset method		Mechanical spring
Actuation type		Electric
Type of control		Direct
Direction of flow		Reversible with restrictions ²⁾
Exhaust air function		With flow control
Manual override		Non-detenting
Mounting position		Any
Width	[mm]	10
Grid dimension	[mm]	14
Nominal width	[mm]	2
Standard nominal flow rate	[l/min]	100
Type of mounting		On PR rail
Pneumatic connection	2 1, 3, 11, 33	Connecting thread M5 Sub-base
Product weight	[g]	60

1) Can be used as a 2/2-way valve by sealing port 3 or 33.

2) Slight leakage can occur in the pressure range -0.8 bar to +0.5 bar.

Operating and environmental conditions	With fast-switching electronics	Without fast-switching electronics
	Operating medium	
Note on operating/pilot medium	Compressed air to ISO 8573-1:2010 [7:4:4]	
Operating pressure	Lubricated operation possible (in which case lubricated operation will always be required)	
Ambient temperature	[bar]	-0.9 ... +8
Temperature of medium	[°C]	-5 ... +40
Restricted ambient and media temperature	[°C]	-5 ... +40
Corrosion resistance class CRC ¹⁾	As a function of switching frequency (see diagram)	
CE marking (see declaration of conformity)	2	
Certification	To EU EMC Directive ²⁾	-
	c UL us Recognized (OL)	c UL us Recognized (OL)
	C-Tick	-

1) Corrosion resistance class 2 according to Festo standard 940 070

Components subject to moderate corrosion stress. Externally visible parts with primarily decorative surface requirements which are in direct contact with a normal industrial environment or media such as coolants or lubricating agents.

2) For information about the applicability of the component see the manufacturer's EC declaration of conformity at: www.festo.com/sp → User documentation.

If the component is subject to restrictions on usage in residential, office or commercial environments or small businesses, further measures to reduce the emitted interference may be necessary.

Solenoid valves MHP2, fast-switching valves

Technical data – Semi in-line valve, 3/2-way valve

Electrical data		With fast-switching electronics	Without fast-switching electronics
Electrical connection		2-pin plug or moulded-in cable	
Operating voltage	[V DC]	24 ±10%	
Power consumption	[W]	5 for approx. 3 ms (high-current phase, pick-up current 1 A)	2.88
	[W]	1.25 (low-current phase)	–
Protection against incorrect polarity		Bipolar	–
Additional functions		Spark arresting	–
		Holding current reduction	–
		Protective circuit	–
Degree of protection to EN 60529	With moulded-in cable	IP65	IP65
	With connecting cable KMYZ-3	IP65	IP65
	With plug socket with cable KMYZ-4	IP50	IP50
	With adapter VAVE-C8	IP65	IP65

Response times and switching frequencies			With fast-switching electronics	Without fast-switching electronics
Switching time	On	[ms]	1.7 +10% ... -30%	7
	Off	[ms]	2 +10% ... -30%	3.5
Switching time variation at 1 Hz and above		[ms]	0.2	–
Maximum switching frequency		[Hz]	330 ¹⁾	130

1) The ambient temperature must be limited with frequencies in excess of 100 Hz.

Current curve for valves with fast-switching electronics (MHP2-MS1H)

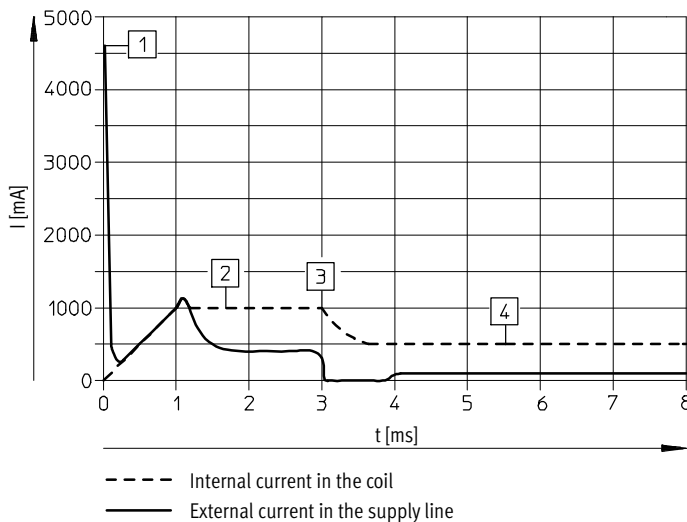

- 1 Capacitor charging
- 2 Controlled coil current 1 A
- 3 Reduction to holding current
- 4 Controlled holding current 0.5 A

Solenoid valves MHP2, fast-switching valves

Technical data – Semi in-line valve, 3/2-way valve

Materials

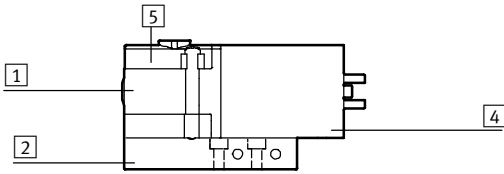

1	Housing	Die-cast zinc, coated
2	Sub-base	Aluminium in the case of the manifold, die-cast zinc in the case of the individual sub-base
4	Coil housing	PA
5	Manifold rail	PA
-	Seals	HNBR, NBR
-	Screws	Galvanised steel
	Note on materials	Free of copper and PTFE

Dimensions

Download CAD data → www.festo.com

Valve with plug vanes, MHP2...-3/2...-M5

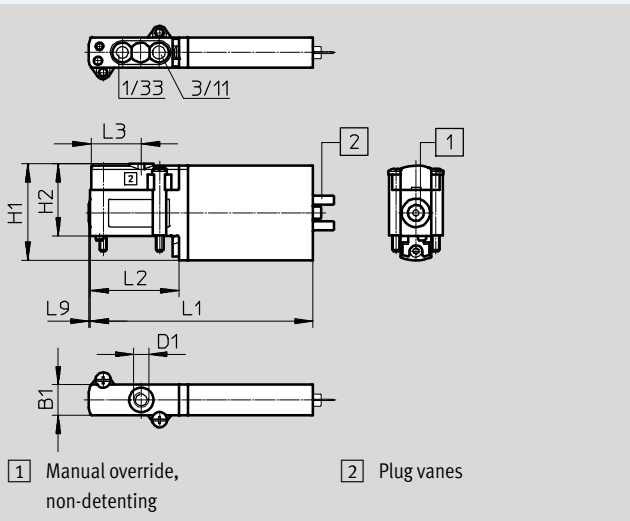

Hole pattern on sub-bases

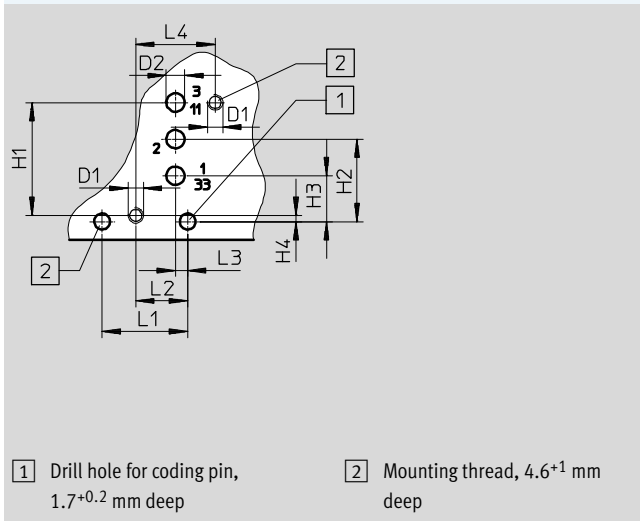

Type	B1	D1	D2 Ø	H1	H2	H3	H4	L1	L2	L3	L4	L9
MHP2...-3/2...-M5	10	M5	-	31.6	23.6	-	-	73	29	16.5	-	0.5
Hole pattern	-	M2.5	3	18.5	13.5	7.5	1	14	8.5	2	13	-

Solenoid valves MHP2, fast-switching valves

Technical data – Semi in-line valve, 3/2-way valve

Dimensions

Download CAD data → www.festo.com

Individual sub-base, MHA2-AS-3-M5

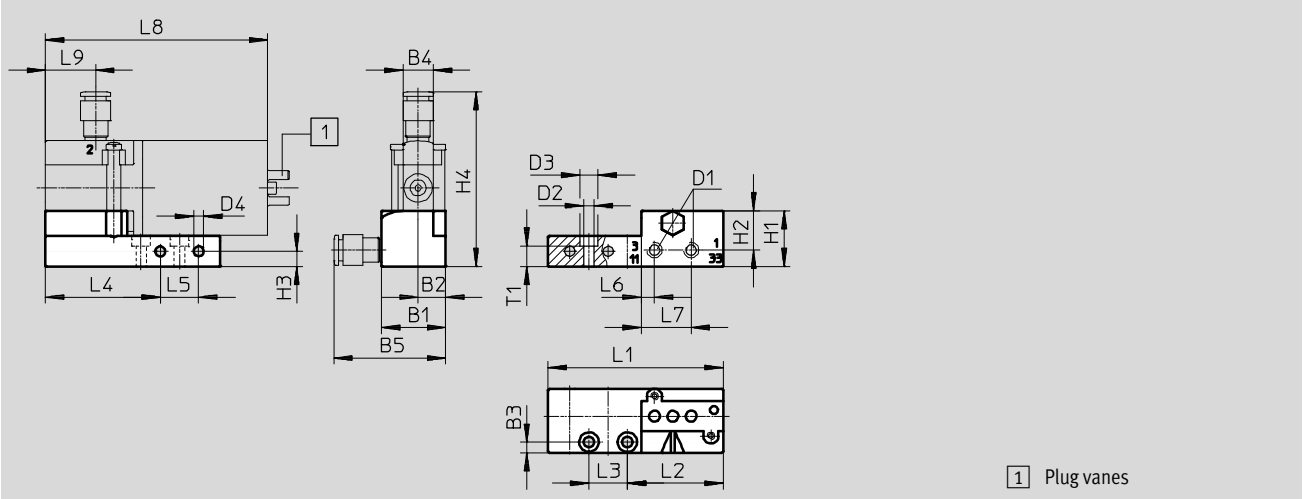

H-rail mounting MHAP2-BG-NRH-35

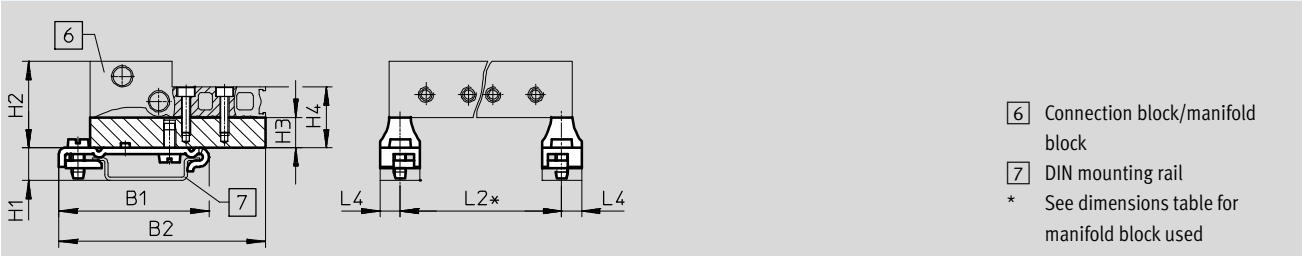

Type	B1	B2	B3	B4	B5	D1	D2	D3	D4	H1	H2	H3	H4	L1	L2	L3	L4	L5	L6	L7	L8	L9	T1
MHA2-AS-3-M5	21	9	3.5	10	36.6	M5	3.4	6	3.3	18.3	12.9	5	57.4	57.4	31.4	12.6	37.7	12.6	4.3	16.3	73	16.5	6.8
MHAP2-BG-NRH-35	49.1	67.6	-	-	-	-	-	-	-	10.7	28.3	10	20	-	*	-	6.5	-	-	-	-	-	-

* See dimensions table for manifold block used

Solenoid valves MHP2, fast-switching valves

Technical data – Semi in-line valve, 3/2-way valve



Dimensions

Download CAD data → www.festo.com

Manifold assembly, MHP2-PR...-3

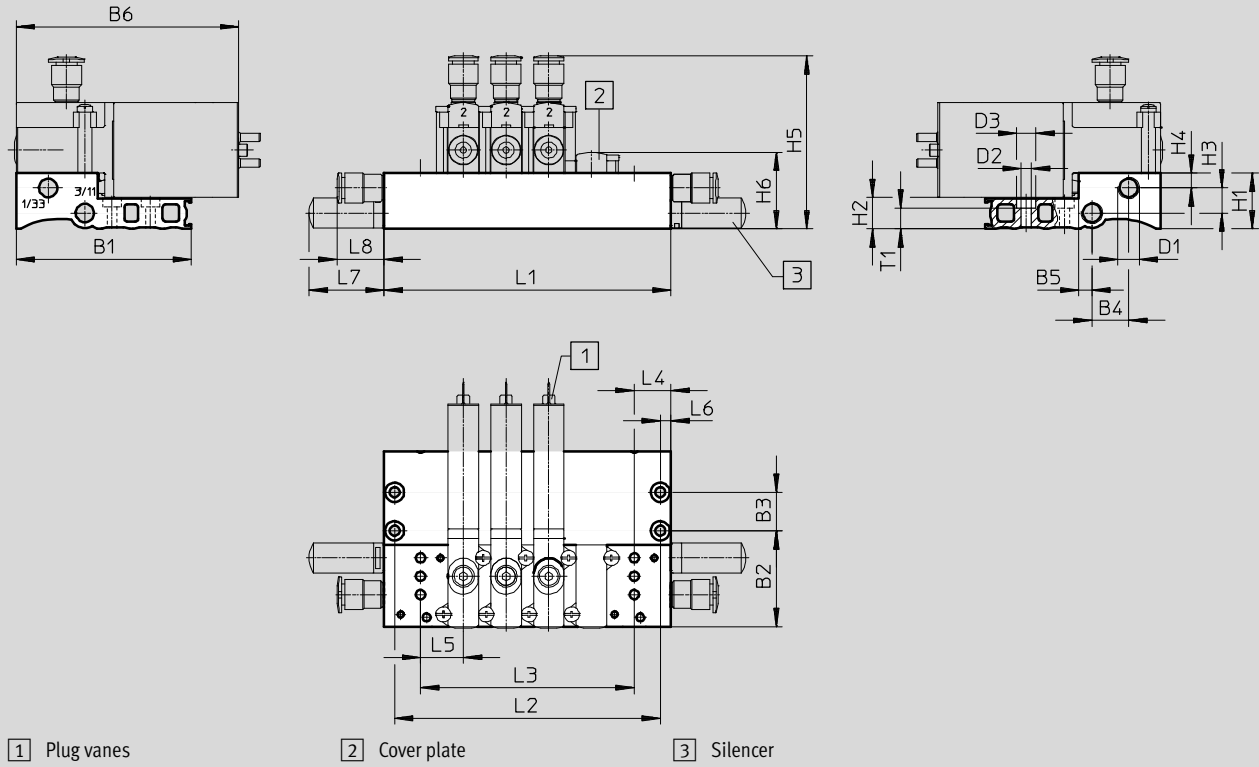

Type	B1	B2	B3	B4	B5	B6	D1	D2	D3	H1	H2	H3	H4	H5	H6	L4	L5	L6	L7	L8	T1
MHP2-PR...-3	57.4	31.4	12.6	12	4.3	73	M7	3.3	6.3	18.3	10	8.2	4.9	56.7	25.1	12	14	3.5	24.5	15.4	6.8







Type		Number of valve positions				
		2	4	6	8	10
MHP2-PR...-3	L1	38	66	94	122	150
	L2	31	59	87	115	143
	L3	14	42	70	98	126

- - Note

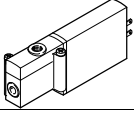
Valve types 3/2G and 3/2O must not be mixed on one manifold block.

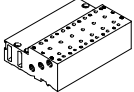
Solenoid valves MHP2, fast-switching valves

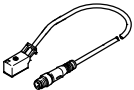
Technical data – Semi in-line valve, 3/2-way valve

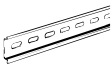



Ordering data					Part No.	Type
Valves						
	With fast-switching electronics	Switching time on 1.7 ms	Normally open	196143	MHP2-MS1H-3/2O-M5	
			Normally closed	196123	MHP2-MS1H-3/2G-M5	
	Without fast-switching electronics	Switching time on 7 ms	Normally open	196142	MHP2-M1H-3/2O-M5	
			Normally closed	196122	MHP2-M1H-3/2G-M5	
Manifold rail						
	Individual sub-base ¹⁾ Pneumatic connection: thread M5		1 valve position	197438	MHA2-AS-3-M5	
	Manifold block Pneumatic connection: thread M7		2 valve positions	197442	MHP2-PR2-3	
			4 valve positions	197443	MHP2-PR4-3	
			6 valve positions	197444	MHP2-PR6-3	
			8 valve positions	197445	MHP2-PR8-3	
			10 valve positions	197446	MHP2-PR10-3	
Blanking plate						
	Vacant valve positions must be sealed with a cover plate			197470	MHAP2-BP-3	
Connecting cable						
	2-pin socket, open cable end 2-wire	PUR cable, degree of protection IP65	Signal status display with LED	2.5 m long	193693	KMYZ-3-24-2,5-LED-PUR-B
				5 m long	193695	KMYZ-3-24-5-LED-PUR-B
				10 m long	196066	KMYZ-3-24-10-LED-PUR-B
		PVC cable, degree of protection IP50	Without signal status display	0.5 m long	193690	KMYZ-4-24-0,5-B
				2.5 m long	193691	KMYZ-4-24-2,5-B
	2-pin socket, plug M8x1 3-pin	PUR cable, degree of protection IP65	Signal status display with LED	0.5 m long	525654	KMYZ-3-24-M8-0,5-LED-PUR
				2.5 m long	525655	KMYZ-3-24-M8-2,5-LED-PUR
Adapter (for valves with plug vanes)						
	2-pin socket	Signal status display with LED	Plug M8, 3-pin	571686	VAVE-C8-1R8	
			Plug M8, 4-pin	573194	VAVE-C8-1R1	
H-rail mounting						
	For 3/2-way solenoid valves			525053	MHAP2-BG-NRH-35	
H-rail						
	To EN 60715		2 m	35430	NRH-35-2000	

1) Seal ports 2 and 4 on the individual sub-base with blanking plugs. These ports have no function when using semi in-line valves.

Solenoid valves MHP2, fast-switching valves

FESTO

Technical data – Semi in-line valve, 3/2-way valve

Ordering data				Part No.	Type
Silencer				Technical data → Internet: uc	
	With threaded connection	M5	1 piece	165003	UC-M5
			50 pieces	534217	UC-M5-50
		M7	1 piece	161418	UC-M7
			50 pieces	534218	UC-M7-50
Push-in fitting				Technical data → Internet: qs	
	Male thread M5 with internal hex for tubing O.D.	4 mm	10 pieces	153315	QSM-M5-4-I
		6 mm	10 pieces	153317	QSM-M5-6-I
	Male thread M7 with internal hex for tubing O.D.	4 mm	10 pieces	153319	QSM-M7-4-I
		6 mm	10 pieces	153321	QSM-M7-6-I
	Male thread M5 with external hex, push-in L-fitting rotatable through 360° for tubing O.D.	4 mm	10 pieces	153333	QSML-M5-4
			100 pieces	130771	QSML-M5-4-100
		6 mm	10 pieces	153335	QSML-M5-6
			100 pieces	130772	QSML-M5-6-100
	Male thread M7 with external hex, push-in L-fitting rotatable through 360° for tubing O.D.	4 mm	10 pieces	186352	QSML-M7-4
			100 pieces	130773	QSML-M7-4-100
		6 mm	10 pieces	186353	QSML-M7-6
			100 pieces	130774	QSML-M7-6-100
Blanking plug					
	For thread M5		10 pieces	3843	B-M5
	For thread M7		10 pieces	174309	B-M7
Inscription label					
	For solenoid valve		80 pieces in frame	197259	MH-BZ-80X

Solenoid valves MHP2, fast-switching valves

Peripherals overview – Semi in-line valve, 5/2-way valve

Connection via plug vanes

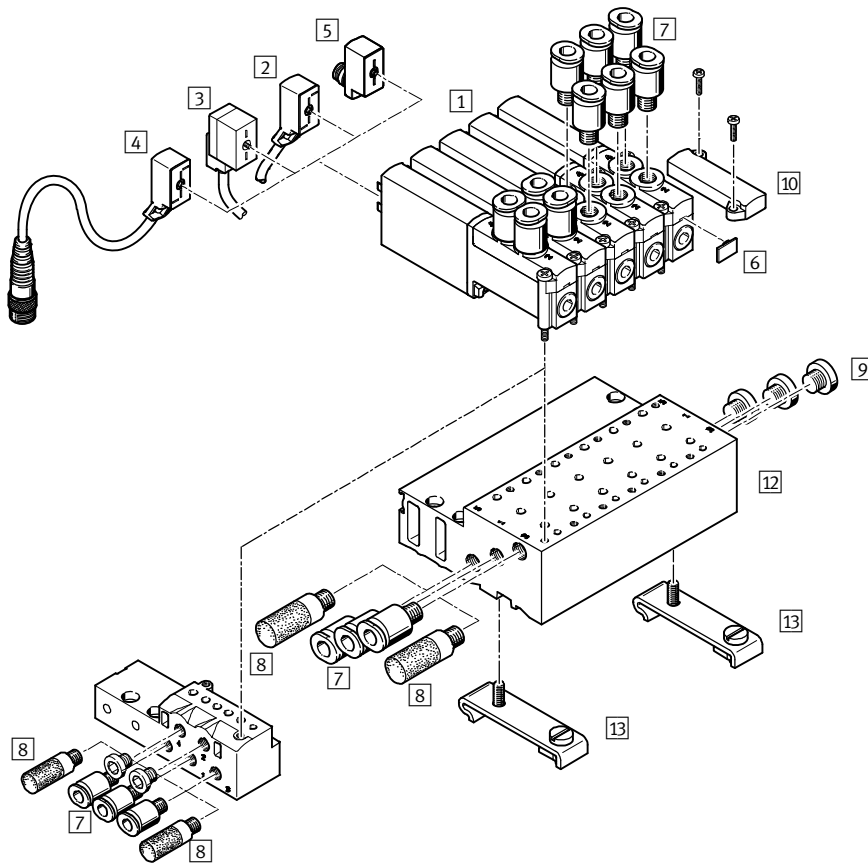

Designation	Brief description	→ Page/Internet
1 Semi in-line valve MHP2	With plug vanes	34
2 Connecting cable KMYZ-3	PUR cable, signal status display with LED, IP65	34
3 Plug socket with cable KMYZ-4	PVC cable, without signal status display, IP50	34
4 Connecting cable KMYZ-3-24-M8	PUR cable, signal status display with LED, plug M8x1 3-pin, IP65	34
5 Adapter VAVE-C8	For connecting the valves via connecting cable M8 3-pin or 4-pin, IP65	34
6 Inscription label MH-BZ-80X	For identifying the valves	35
7 Push-in fittings QS	For connecting compressed air tubing with standard O.D.	35
8 Silencer UC	For mounting in exhaust ports	35
9 Blanking plug B	For sealing unused ports	35
10 Cover plate MHAP2-BP-5	For sealing vacant positions	34
11 Individual sub-base MHA2-AS-5-M5	For semi in-line valves, the individual sub-base is also used for sub-base valves and must be sealed with a blanking plug here	34
12 Manifold block MHP2-PR...-5	For semi in-line valves	34
13 H-rail mounting CPV10/14-VI-BG-NRH-35	For mounting the manifold block on H-rails according to EN 60715	34

Solenoid valves MHP2, fast-switching valves

Technical data – Semi in-line valve, 5/2-way valves

FESTO

Function

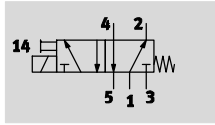

-  - Voltage
24 V DC

-  - Pressure
-0.9 ... +8 bar

-  - Temperature range
-5 ... +40 °C



General technical data		
Valve function		5/2-way, single solenoid
Design		Pressure-relieved poppet valve
Sealing principle		Soft
Reset method		Mechanical spring
Actuation type		Electric
Type of control		Direct
Direction of flow		Non-reversible
Exhaust function		With flow control
Manual override		Non-detenting
Mounting position		Any
Width	[mm]	10
Grid dimension	[mm]	14
Nominal width	[mm]	2
Standard nominal flow rate	[l/min]	90
Type of mounting		On PR rail
Tightening torque, valve mounting	[Nm]	Max. 0.4
Pneumatic connection	1, 3, 5	Sub-base
	2, 4	Connecting thread M5
Tightening torque for fitting	[Nm]	Max. 1.5
Product weight	[g]	70

Operating and environmental conditions		
Operating medium		Compressed air to ISO 8573-1:2010 [7:4:4]
Note on operating/pilot medium		Lubricated operation possible (in which case lubricated operation will always be required)
Operating pressure	[bar]	-0.9 ... +8
Ambient temperature	[°C]	-5 ... +40
Temperature of medium	[°C]	-5 ... +40
Restricted ambient and media temperature		As a function of switching frequency (see diagram)
Corrosion resistance class CRC ¹⁾		2
CE marking (see declaration of conformity)		To EU EMC Directive ²⁾
Approval certificate		cULus Recognized (OL)
		C-Tick

- 1) Corrosion resistance class 2 according to Festo standard 940 070
Components subject to moderate corrosion stress. Externally visible parts with primarily decorative surface requirements which are in direct contact with a normal industrial environment or media such as coolants or lubricating agents.
- 2) For information about the applicability of the component see the manufacturer's EC declaration of conformity at: www.festo.com/sp → User documentation.
If the component is subject to restrictions on usage in residential, office or commercial environments or small businesses, further measures to reduce the emitted interference may be necessary.

Solenoid valves MHP2, fast-switching valves

Technical data – Semi in-line valve, 5/2-way valves

Electrical data			
Electrical connection		Plug, 2-pin	
Operating voltage		[V DC]	24 ±10%
Power consumption	Low-current phase	[W]	1.625
	High-current phase	[W]	6.5
Protection against incorrect polarity		Bipolar	
Additional functions		Spark arresting	
		Holding current reduction	
		Protective circuit	
Degree of protection to EN 60529	With connecting cable KMYZ-3		IP65
	With plug socket with cable KMYZ-4		IP50
	With adapter VAVE-C8		IP65

Response times and switching frequencies			
Switching time	On	[ms]	1.9 +10% ... -30%
	Off	[ms]	1.7 +10% ... -30%
Maximum switching frequency		[Hz]	300 ¹⁾
Switching time variation at 1 Hz and above		[ms]	0.2

1) The ambient temperature must be limited with frequencies in excess of 75 Hz.

Current curve for valves with fast-switching electronics (MHP2-MS1H)

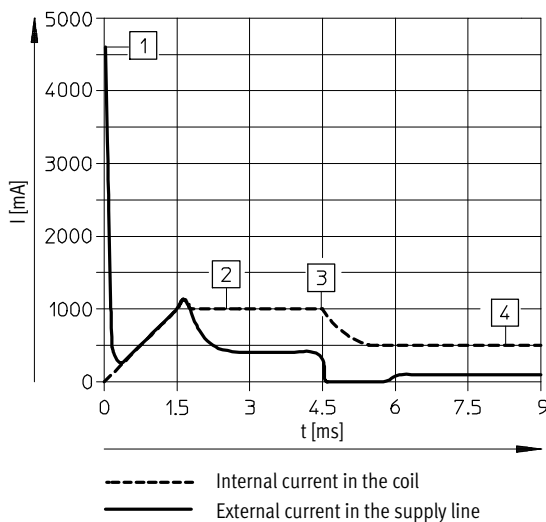

- 1) Capacitor charging
- 2) Controlled coil current 1 A
- 3) Reduction to holding current
- 4) Controlled holding current 0.5 A

Materials

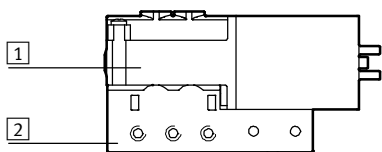

1	Housing	Die-cast zinc, coated
2	Sub-base	Die-cast zinc
-	Seals	HNBR, NBR
-	Screws	Galvanised steel
Note on materials		Free of copper and PTFE
		RoHS-compliant

Solenoid valves MHP2, fast-switching valves

Technical data – Semi in-line valve, 5/2-way valves

Dimensions

Download CAD data → www.festo.com

Valve with plug vanes, MHP2-...-5/2...-M5

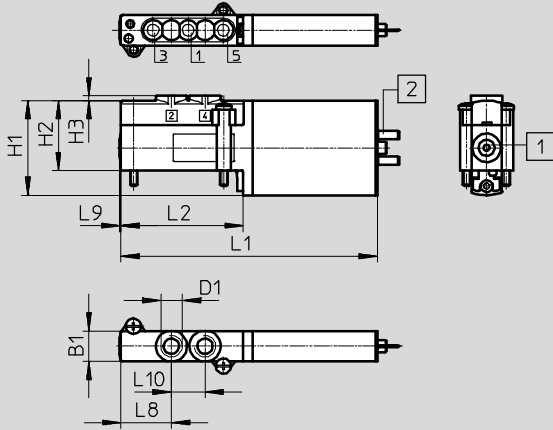

- 1 Manual override, non-detenting
- 2 Plug vanes

Hole pattern on sub-bases

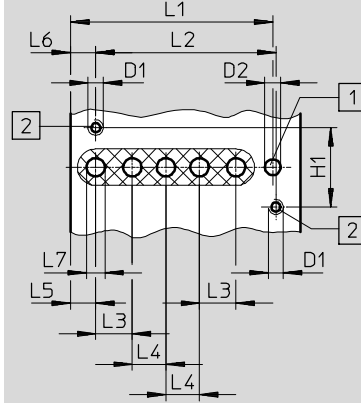

- 1 Drill hole for coding pin, 1.7^{+0.2} mm deep
- 2 Mounting thread, 4.6⁺¹ mm deep

Type	B1	D1	D2 ∅	H1	H2	H3	H4	L1	L2	L3	L4	L5	L6	L7	L8	L9	L10
MHP2-...-5/2...-M5	10	M5	-	31	23	1.5	-	84	40	-	-	-	-	-	16.5	0.5	11
Hole pattern	-	M2.5	2.6	13	-	-	-	33.1	29.5	6	5.5	4.1	4.1	3	-	-	-

- - Note
Semi in-line valves have no ports 2 and 4.

Individual sub-base, MHA2-AS-5-M5

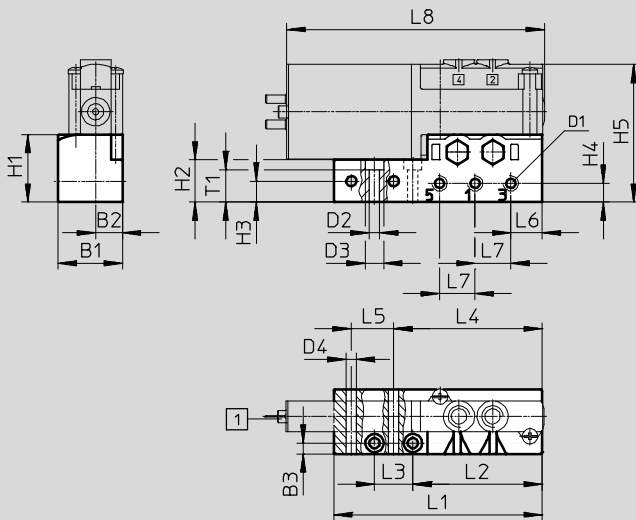

- 1 Plug vanes

Type	B1	B2	B3	D1	D2 ∅	D3 ∅	D4 ∅	H1	H2	H3	H4	H5	L1	L2	L3	L4	L5	L6	L7	L8	T1
MHA2-AS-5-M5	21	8.8	3.5	M5	3.4	6	3.3	22.2	13.9	6.9	6.2	45.2	68.4	42.4	12.6	48.7	13.9	10.3	11.7	84.5	10.7

Solenoid valves MHP2, fast-switching valves

Technical data – Semi in-line valve, 5/2-way valves

Dimensions

Download CAD data → www.festo.com

Manifold assembly, MHP2-PR...-5

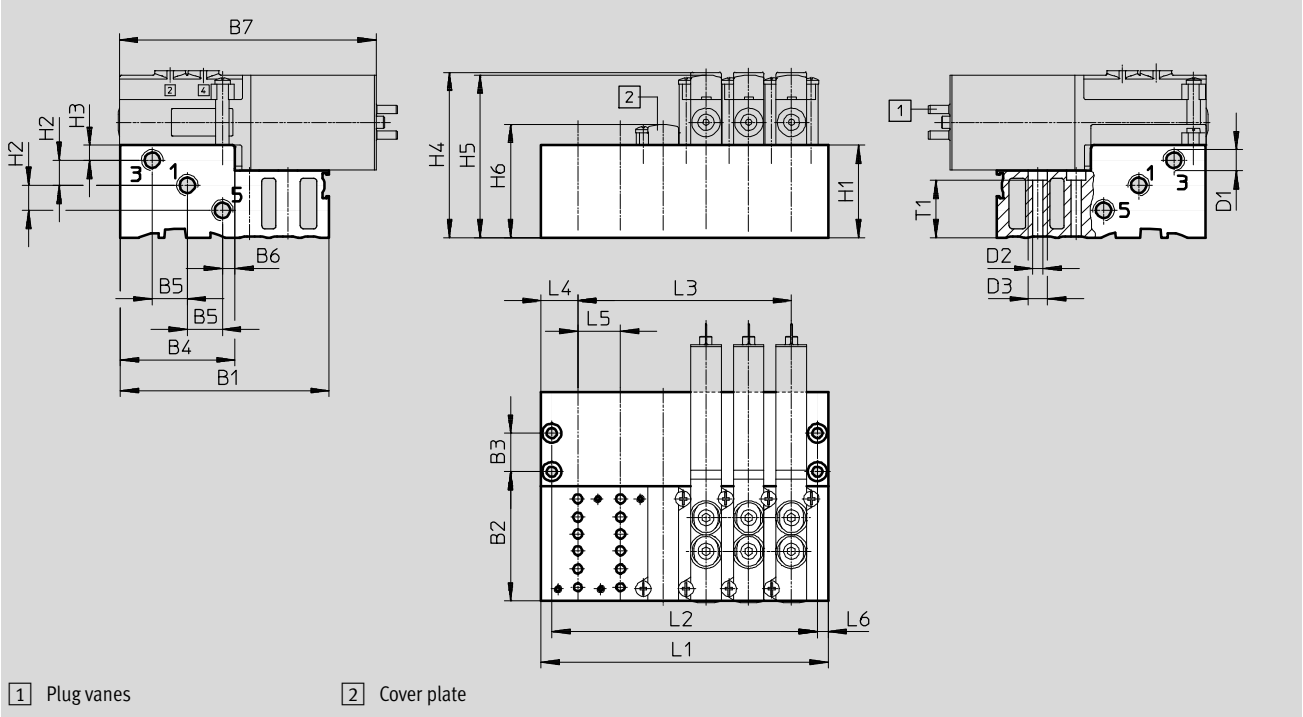







Type	B1	B2	B3	B4	B5	B6	B7	D1	D2	D3	H1	H2	H3	H4	H5	H6	L4	L5	L6	T1
MHP2-PR...-5	68.4	42.4	12.6	37.6	11.5	4.1	84	M7	3.3	6.3	30.3	8.2	4.9	54.8	53.3	37.1	12	14	3.5	18.8

Type	Number of valve positions										
	2		4		6	8		10			
MHP2-PR...-5	L1	38		66		94		122		150	
	L2	31		59		87		115		143	
	L3	14		42		70		98		126	

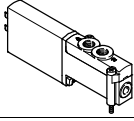
Solenoid valves MHP2, fast-switching valves

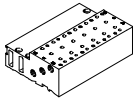
FESTO

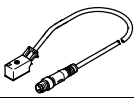

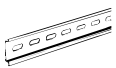

Technical data – Semi in-line valve, 5/2-way valve

Ordering data					Part No.	Type
Valves						
	With fast-switching electronics	Switching time on 1.9 ms			525105	MHP2-MS1H-5/2-M5
Manifold rail						
	Individual sub-base ¹⁾ Pneumatic connection: thread M5	1 valve position			525120	MHA2-AS-5-M5
	Manifold block Pneumatic connection 1, 3, 5: thread M7	2 valve positions			525122	MHP2-PR2-5
		4 valve positions			525123	MHP2-PR4-5
		6 valve positions			525124	MHP2-PR6-5
		8 valve positions			525125	MHP2-PR8-5
		10 valve positions			525126	MHP2-PR10-5
Cover plate						
	Vacant valve positions must be sealed with a cover plate				525132	MHAP2-BP-5
Connecting cable						
	2-pin socket, open cable end 2-wire	PUR cable, degree of protection IP65	Signal status display with LED	2.5 m long	193693	KMYZ-3-24-2,5-LED-PUR-B
				5 m long	193695	KMYZ-3-24-5-LED-PUR-B
				10 m long	196066	KMYZ-3-24-10-LED-PUR-B
		PVC cable, degree of protection IP50	Without signal status display	0.5 m long	193690	KMYZ-4-24-0,5-B
				2.5 m long	193691	KMYZ-4-24-2,5-B
	2-pin socket, plug M8x1 3-pin	PUR, degree of protection IP65	Signal status display with LED	0.5 m long	525654	KMYZ-3-24-M8-0,5-LED-PUR
				2.5 m long	525655	KMYZ-3-24-M8-2,5-LED-PUR
Adapter (for valves with plug vanes)						
	2-pin socket	Signal status display with LED	Plug M8, 3-pin	571686	VAVE-C8-1R8	
			Plug M8, 4-pin	573194	VAVE-C8-1R1	
H-rail mounting						
	For 5/2-way solenoid valves				162556	CPV10/14-VI-BG-NRH-35
H-rail						
	To EN 60715			2 m	35430	NRH-35-2000

1) Seal ports 2 and 4 on the individual sub-base with blanking plugs. These ports have no function when using semi in-line valves.

Solenoid valves MHP2, fast-switching valves

Technical data – Semi in-line valve, 5/2-way valve

Ordering data					
				Part No.	Type
Silencer Technical data → Internet: uc					
	With threaded connection	M5	1 piece	165003	UC-M5
			50 pieces	534217	UC-M5-50
		M7	1 piece	161418	UC-M7
			50 pieces	534218	UC-M7-50
Push-in fitting Technical data → Internet: qs					
	Male thread M5 with internal hex for tubing O.D.	4 mm	10 pieces	153315	QSM-M5-4-I
		6 mm	10 pieces	153317	QSM-M5-6-I
	Male thread M7 with internal hex for tubing O.D.	4 mm	10 pieces	153319	QSM-M7-4-I
			100 pieces	133006	QSM-M7-4-I-100
	Male thread M5 with external hex, push-in L-fitting rotatable through 360° for tubing O.D.	4 mm	10 pieces	153333	QSML-M5-4
			100 pieces	130771	QSML-M5-4-100
		6 mm	10 pieces	153335	QSML-M5-6
			100 pieces	130772	QSML-M5-6-100
	Male thread M7 with external hex, push-in L-fitting rotatable through 360° for tubing O.D.	4 mm	10 pieces	186352	QSML-M7-4
			100 pieces	130773	QSML-M7-4-100
		6 mm	10 pieces	186353	QSML-M7-6
			100 pieces	130774	QSML-M7-6-100
Blanking plug					
	For thread M5		10 pieces	3843	B-M5
	For thread M7		10 pieces	174309	B-M7
Inscription label					
	For solenoid valve		80 pieces in frame	197259	MH-BZ-80X

Solenoid valves MHA2, fast-switching valves

Peripherals overview – Sub-base valve, 3/2-way valve

Connection with plug vanes – Connection with moulded-in cable

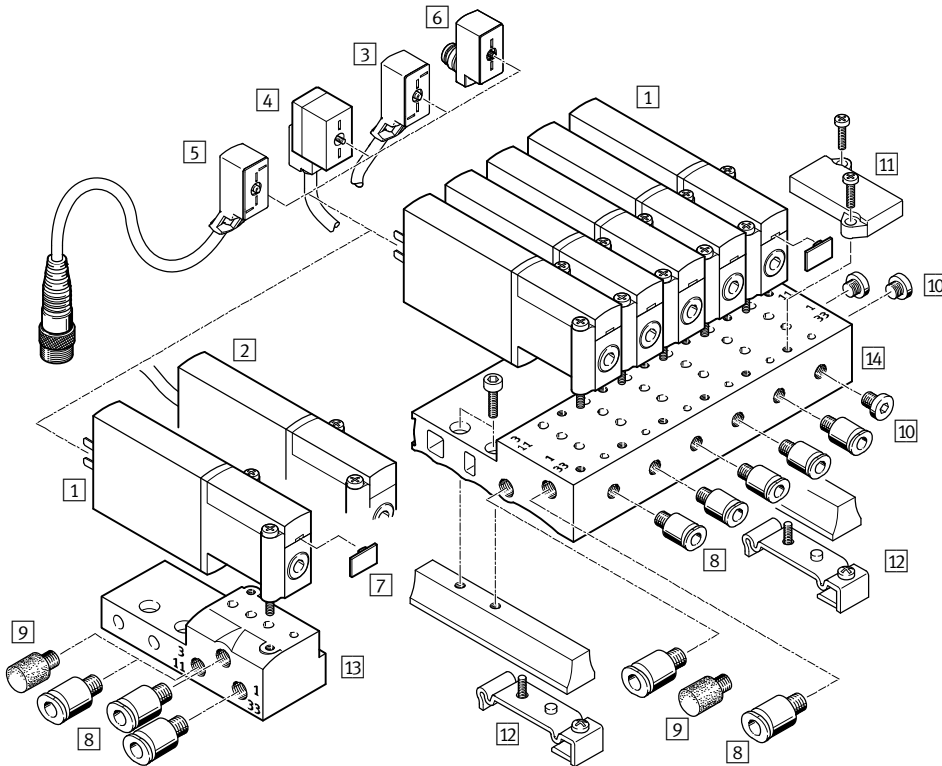

Designation	Brief description	→ Page/Internet
1 Sub-base valve MHA2	With plug vanes	42
2 Sub-base valve MHA2-...-K	With moulded-in cable	42
3 Connecting cable KMYZ-3	PUR cable, signal status display with LED, IP65	42
4 Plug socket with cable KMYZ-4	PVC cable, without signal status display, IP50	42
5 Connecting cable KMYZ-3-24-M8	PUR cable, signal status display with LED, plug M8x1 3-pin, IP65	42
6 Adapter VAVE-C8	For connecting the valves via connecting cable M8 3-pin or 4-pin, IP65	43
7 Inscription label MH-BZ-80X	For identifying the valves	43
8 Push-in fittings QS	For connecting compressed air tubing with standard O.D.	43
9 Silencer UC	For mounting in exhaust ports	43
10 Blanking plug B	For sealing unused ports	43
11 Cover plate MHAP2-BP-3	For sealing vacant positions	42
12 H-rail mounting MHAP2-BG-NRH-35	For mounting the manifold block on H-rails according to EN 60715	43
13 Individual sub-base MHA2-AS-3-M5	For sub-base valve	42
14 Manifold block MHA2-PR-...-3-M5	For sub-base valve	42

Solenoid valves MHA2, fast-switching valves

FESTO

Technical data – Sub-base valve, 3/2-way valve

Function

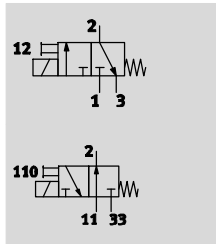

Voltage
24 V DC



Pressure
-0.9 ... +8 bar



Temperature range
-5 ... +40 °C

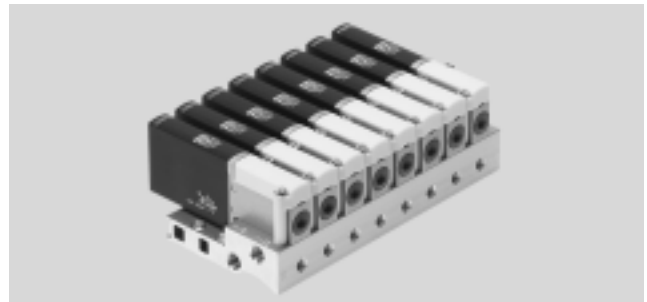

General technical data		
Valve function		3/2 way, single solenoid ¹⁾
Design		Pressure-relieved poppet valve
Sealing principle		Soft
Reset method		Mechanical spring
Actuation type		Electric
Type of control		Direct
Direction of flow		Non-reversible
Exhaust function		With flow control
Manual override		Non-detenting
Mounting position		Any
Width	[mm]	10
Grid dimension	[mm]	14
Nominal width	[mm]	2
Standard nominal flow rate	[l/min]	100
Type of mounting		On sub-base
Pneumatic connection		Sub-base
Product weight	[g]	60

1) Can be used as a 2/2-way valve by sealing port 3 or 33

Operating and environmental conditions		
	With fast-switching electronics	Without fast-switching electronics
Operating medium	Compressed air to ISO 8573-1:2010 [7:4:4]	
Note on operating/pilot medium	Lubricated operation possible (in which case lubricated operation will always be required)	
Operating pressure	[bar]	-0.9 ... +8
Ambient temperature	[°C]	-5 ... +40
Temperature of medium	[°C]	-5 ... +40
Restricted ambient and media temperature	As a function of switching frequency (see diagram)	
Corrosion resistance class CRC ¹⁾	2	
CE marking (see declaration of conformity)	To EU EMC Directive ²⁾	–
Certification	c UL us Recognized (OL)	c UL us Recognized (OL)
	C-Tick	–

- 1) Corrosion resistance class 2 according to Festo standard 940 070
Components subject to moderate corrosion stress. Externally visible parts with primarily decorative surface requirements which are in direct contact with a normal industrial environment or media such as coolants or lubricating agents.
- 2) For information about the applicability of the component see the manufacturer's EC declaration of conformity at: www.festo.com/sp → User documentation.
If the component is subject to restrictions on usage in residential, office or commercial environments or small businesses, further measures to reduce the emitted interference may be necessary.

Solenoid valves MHA2, fast-switching valves

Technical data – Sub-base valve, 3/2-way valve

Electrical data		With fast-switching electronics	Without fast-switching electronics
Electrical connection		2-pin plug or moulded-in cable	
Operating voltage	[V DC]	24 ±10%	
Power consumption	[W]	5 for approx. 3 ms (high-current phase, pick-up current 1 A)	2.88
	[W]	1.25 (low-current phase)	–
Protection against incorrect polarity		Bipolar	–
Additional functions		Spark arresting	–
		Holding current reduction	–
		Protective circuit	–
Degree of protection to EN 60529	With moulded-in cable	IP65	IP65
	With connecting cable KMYZ-3	IP65	IP65
	With plug socket with cable KMYZ-4	IP50	IP50
	With adapter VAVE-C8	IP65	IP65

Response times and switching frequencies			
		With fast-switching electronics	Without fast-switching electronics
Switching time	On [ms]	1.7 +10% ... -30%	7
	Off [ms]	2 +10% ... -30%	3.5
Switching time variation at 1 Hz and above	[ms]	0.2	–
Maximum switching frequency	[Hz]	330 ¹⁾	130

1) The ambient temperature must be limited with frequencies in excess of 100 Hz.

Current curve for valves with fast-switching electronics (MHA2-MS1H)

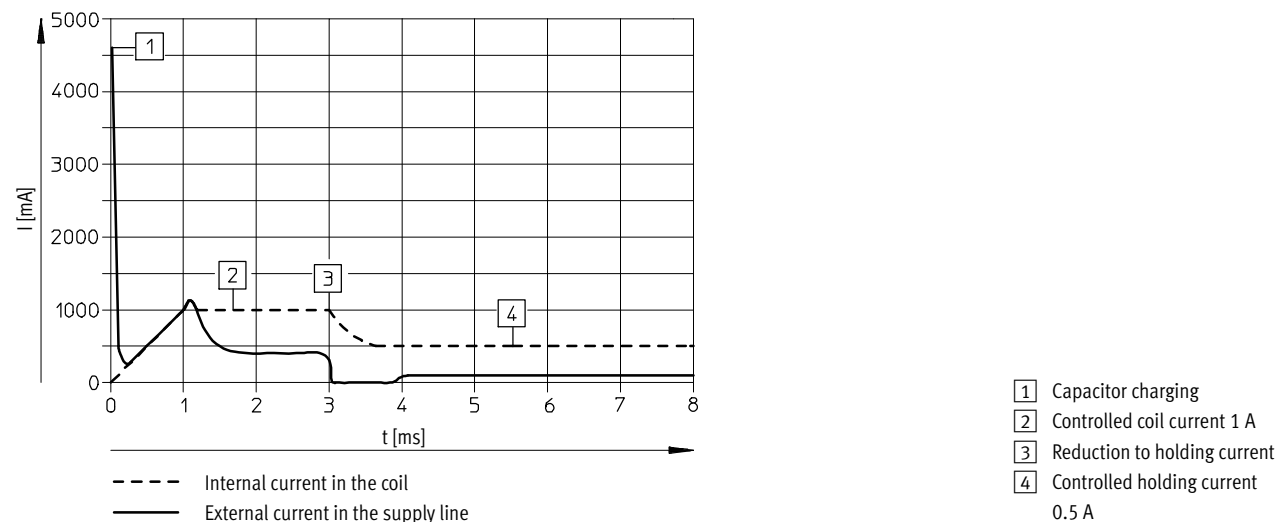

Solenoid valves MHA2, fast-switching valves

Technical data – Sub-base valve, 3/2-way valve

Materials

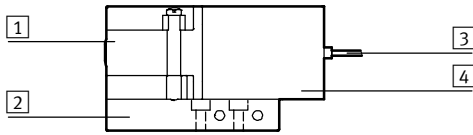

1	Housing	Die-cast zinc, coated
2	Sub-base	Aluminium in the case of the manifold, die-cast zinc in the case of the individual sub-base
3	Cable sheath	PUR
4	Coil housing	PA
-	Seals	HNBR, NBR
-	Screws	Galvanised steel
Note on materials		Free of copper and PTFE RoHS-compliant ¹⁾

1) Not RoHS-compliant: MHA2-MS1H-3/2G-2, MHA2-MS1H-3/2G-2-K, MHA2-M1H-3/2O-2-K

Dimensions

Download CAD data → www.festo.com

Valve with plug vanes or moulded-in cable, MHA2-...-3/2...

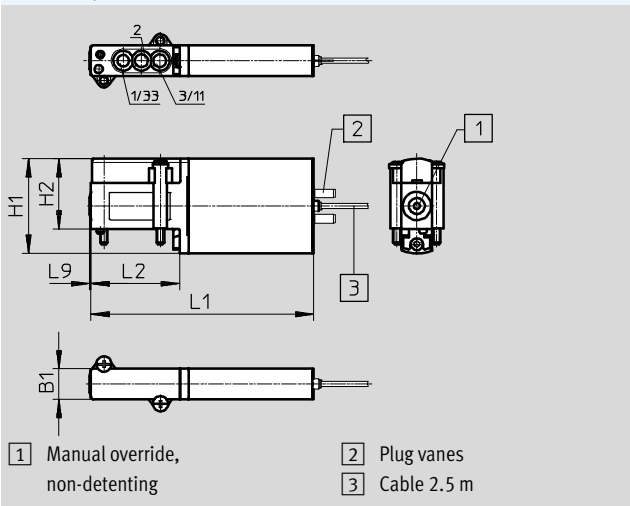

Hole pattern on sub-bases

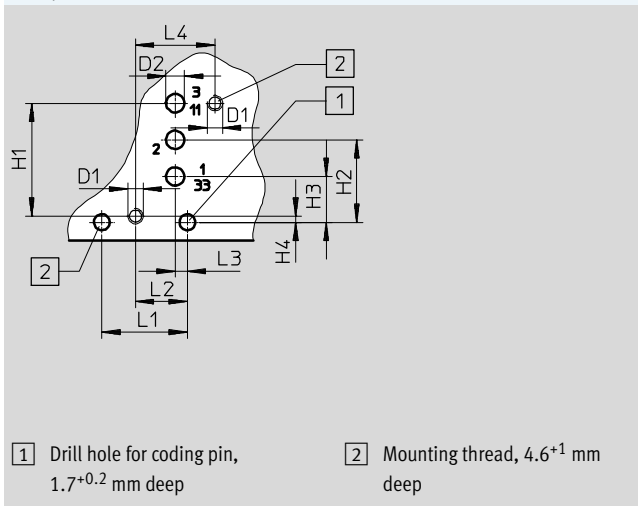

Type	B1	D1	D2 ∅	H1	H2	H3	H4	L1	L2	L3	L4	L9
MHA2-...-3/2...	10	-	-	31	23	-	-	73	29	-	-	0.5
Hole pattern	-	M2.5	3	18.5	13.5	7.5	1	14	8.5	2	13	-

Solenoid valves MHA2, fast-switching valves

Technical data – Sub-base valve, 3/2-way valve

Dimensions

Download CAD data → www.festo.com

Individual sub-base, MHA2-AS-3-M5

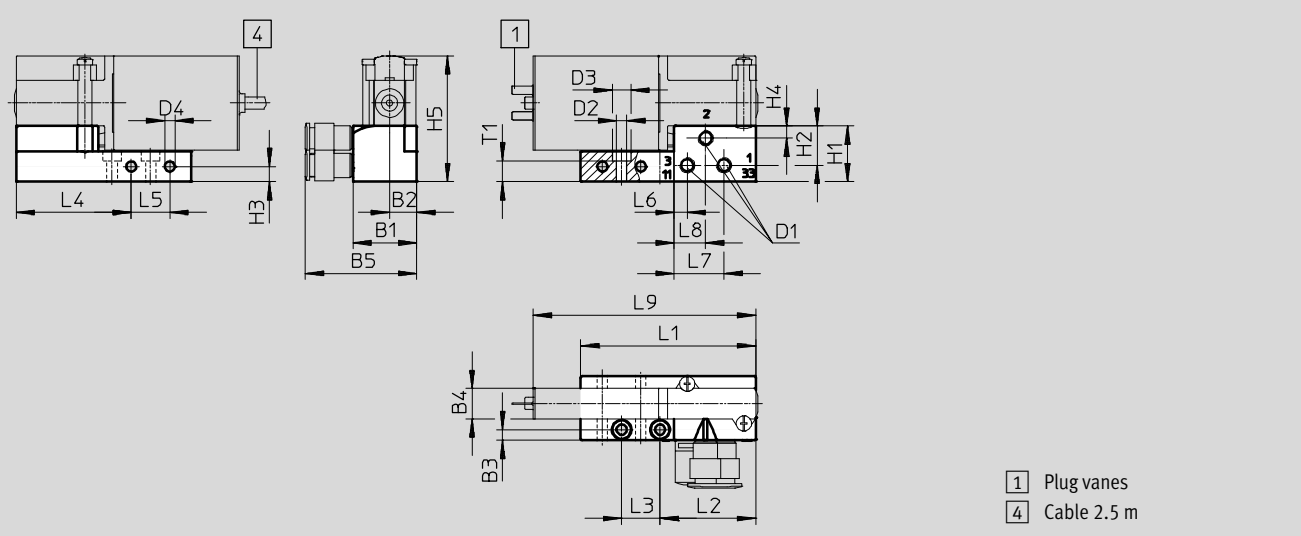

- 1 Plug vanes
- 4 Cable 2.5 m

H-rail mounting MHAP2-BG-NRH-35

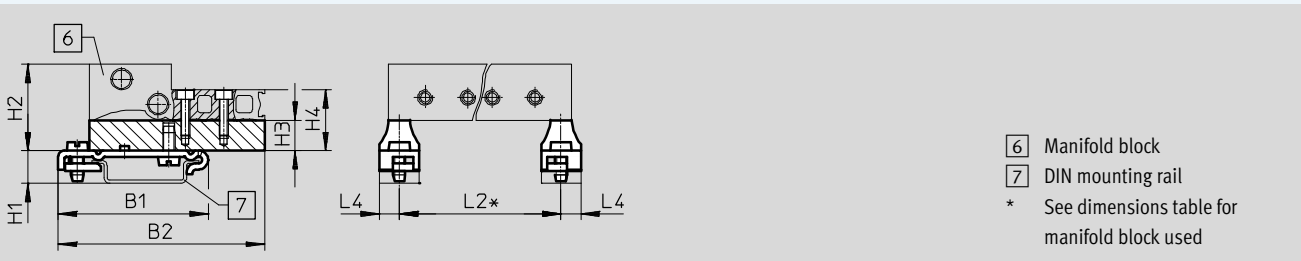

- 6 Manifold block
- 7 DIN mounting rail
- * See dimensions table for manifold block used

Type	B1	B2	B3	B4	B5	D1	D2	D3	D4	H1	H2	H3	H4	H5
MHA2-AS-3-M5	21	9	3.5	10	36.6	M5	3.4	6	3.3	18.3	12.9	5	4	41.3
MHAP2-BG-NRH-35	49.1	67.6	-	-	-	-	-	-	-	10.7	28.3	10	20	20

Type	L1	L2	L3	L4	L5	L6	L7	L8	L9	T1
MHA2-AS-3-M5	57.4	31.4	12.6	37.7	12.6	4.3	16.3	10.3	73	6.8
MHAP2-BG-NRH-35	-	*	-	6.5	-	-	-	-	-	-

* See dimensions table for manifold block used

Solenoid valves MHA2, fast-switching valves

Technical data – Sub-base valve, 3/2-way valve

Dimensions

Download CAD data → www.festo.com

Manifold assembly, MHA2-PR...-3-M5

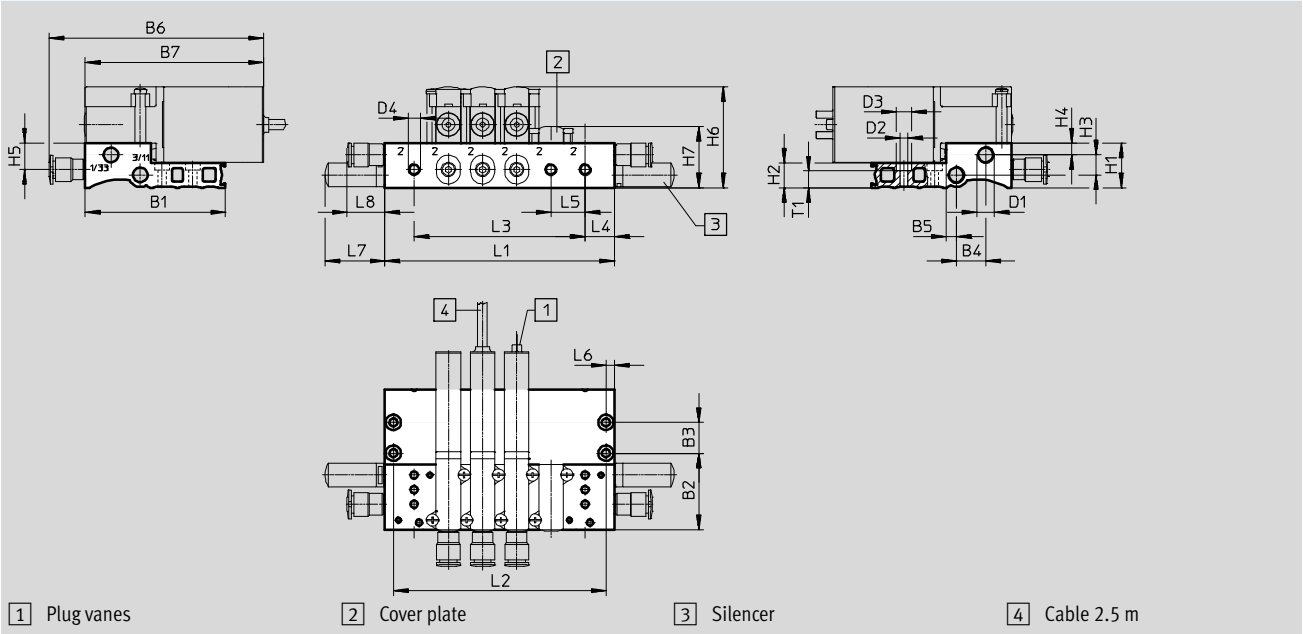

Type	B1	B2	B3	B4	B5	B6	B7	D1	D2 ∅	D3 ∅	D4 ∅	H1	H2	H3	H4	H5	H6	H7
MHP2-PR...-3-M5	57.4	31.4	12.6	12	4.3	87.9	73	M7	3.3	6.3	M5	18.3	10	8.2	4.9	10.9	41.3	25.1

Type	L4	L5	L6	L7	L8	T1
MHP2-PR...-3-M5	12	14	3.5	24.5	15.4	6.8

Type	Number of valve positions					
		2	4	6	8	10
MHP2-PR...-3-M5	L1	38	66	94	122	150
	L2	31	59	87	115	143
	L3	14	42	70	98	126





-  - Note

Valve types 3/2G and 3/2O must not be mixed on one manifold block.

Solenoid valves MHA2, fast-switching valves

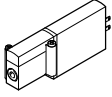
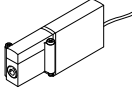
FESTO

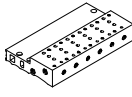
Technical data – Sub-base valve, 3/2-way valve

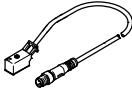



Ordering data				Part No.	Type	
Valves						
	Electrical connection: plug vanes	With fast-switching electronics, switching time 2 ms	Normally open	196139	MHA2-MS1H-3/20-2	
			Normally closed	196119	MHA2-MS1H-3/2G-2¹⁾	
		Without fast-switching electronics, switching time 7 ms	Normally open	196138	MHA2-M1H-3/20-2	
			Normally closed	196118	MHA2-M1H-3/2G-2	
	Electrical connection: cable	With fast-switching electronics, switching time 2 ms	Normally open	196141	MHA2-MS1H-3/20-2-K	
			Normally closed	196121	MHA2-MS1H-3/2G-2-K¹⁾	
		Without fast-switching electronics, switching time 7 ms	Normally open	196140	MHA2-M1H-3/20-2-K¹⁾	
			Normally closed	196120	MHA2-M1H-3/2G-2-K	
Manifold rail						
	Individual sub-base Pneumatic connection: thread M5		1 valve position	197438	MHA2-AS-3-M5	
	Manifold block Pneumatic connection 1, 11, 3, 33: thread M7 Pneumatic connection 2: thread M5		2 valve positions	197447	MHA2-PR2-3-M5	
			4 valve positions	197448	MHA2-PR4-3-M5	
			6 valve positions	197449	MHA2-PR6-3-M5	
			8 valve positions	197450	MHA2-PR8-3-M5	
			10 valve positions	197451	MHA2-PR10-3-M5	
Cover plate						
	Vacant valve positions must be sealed with a cover plate			197470	MHAP2-BP-3	
Connecting cable						
	2-pin socket, open cable end 2-wire	PUR cable, degree of protection IP65	Signal status display with LED	2.5 m long	193693	KMYZ-3-24-2,5-LED-PUR-B
				5 m long	193695	KMYZ-3-24-5-LED-PUR-B
		PVC cable, degree of protection IP50	Without signal status display	10 m long	196066	KMYZ-3-24-10-LED-PUR-B
				0.5 m long	193690	KMYZ-4-24-0,5-B
				2.5 m long	193691	KMYZ-4-24-2,5-B
	2-pin socket, plug M8x1 3-pin	PUR cable, degree of protection IP65	Signal status display with LED	0.5 m long	525654	KMYZ-3-24-M8-0,5-LED-PUR
				2.5 m long	525655	KMYZ-3-24-M8-2,5-LED-PUR

1) Not RoHS-compliant

-  - Note
Valve types 3/2G and 3/2O must not be mixed on one manifold block.

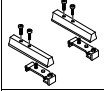
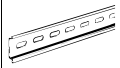
Solenoid valves MHA2, fast-switching valves

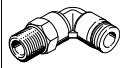
Technical data – Sub-base valve, 3/2-way valve

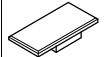
Ordering data					Part No.	Type
Adapter (for valves with plug vanes)						
	2-pin socket	Signal status display with LED	Plug M8, 3-pin	571686	VAVE-C8-1R8	
			Plug M8, 4-pin	573194	VAVE-C8-1R1	
H-rail mounting						
	For 3/2-way solenoid valves			525053	MHAP2-BG-NRH-35	
H-rail						
	To EN 60715		2 m	35430	NRH-35-2000	
Silencer Technical data → Internet: uc						
	With threaded connection	M5	1 piece	165003	UC-M5	
			50 pieces	534217	UC-M5-50	
		M7	1 piece	161418	UC-M7	
			50 pieces	534218	UC-M7-50	
Push-in fitting Technical data → Internet: qs						
	Male thread M5 with internal hex for tubing O.D.	4 mm	10 pieces	153315	QSM-M5-4-I	
		6 mm	10 pieces	153317	QSM-M5-6-I	
	Male thread M7 with internal hex for tubing O.D.	4 mm	10 pieces	153319	QSM-M7-4-I	
			100 pieces	133006	QSM-M7-4-I-100	
	Male thread M5 with external hex, push-in L-fitting rotatable through 360° for tubing O.D.	4 mm	10 pieces	153333	QSML-M5-4	
			100 pieces	130771	QSML-M5-4-100	
	6 mm	10 pieces	153335	QSML-M5-6		
		100 pieces	130772	QSML-M5-6-100		
	Male thread M7 with external hex, push-in L-fitting rotatable through 360° for tubing O.D.	4 mm	10 pieces	186352	QSML-M7-4	
			100 pieces	130773	QSML-M7-4-100	
6 mm	10 pieces	186353	QSML-M7-6			
	100 pieces	130774	QSML-M7-6-100			
Blanking plug						
	For thread M5		10 pieces	3843	B-M5	
	For thread M7		10 pieces	174309	B-M7	
Inscription label						
	For solenoid valve		80 pieces in frame	197259	MH-BZ-80X	

Solenoid valves MHA2, fast-switching valves

Peripherals overview – Sub-base valve, 5/2-way valve

Connection with plug vanes – Connection with moulded-in cable

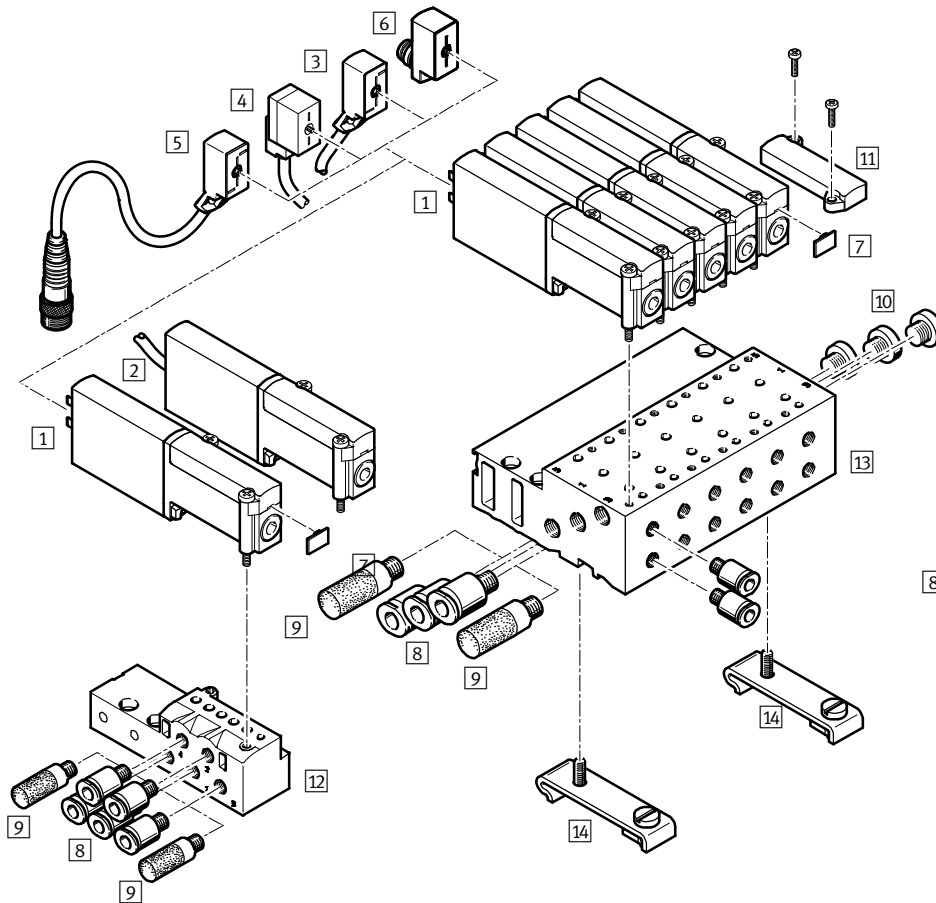

Designation	Brief description	→ Page/Internet
1 Sub-base valve MHA2	With plug vanes	50
2 Sub-base valve MHA2...-K	With moulded-in cable	50
3 Connecting cable KMYZ-3	PUR cable, signal status display with LED, IP65	50
4 Plug socket with cable KMYZ-4	PVC cable, signal switching status display, IP50	50
5 Connecting cable KMYZ-3-24-M8	PUR cable, signal status display with LED, plug M8x1 3-pin, IP65	50
6 Adapter VAVE-C8	For connecting the valves via connecting cable M8 3-pin or 4-pin, IP65	51
7 Inscription label MH-BZ-80X	For identifying the valves	51
8 Push-in fittings QS	For connecting compressed air tubing with standard O.D.	51
9 Silencer UC	For mounting in exhaust ports	51
10 Blanking plug B	For sealing unused ports	51
11 Cover plate MHAP2-BP-5	For sealing vacant positions	50
12 Individual sub-base MHA2-AS-5-M5	For sub-base valve	50
13 Manifold block MHA2-PR...-5-M5	For sub-base valve	50
14 H-rail mounting CPV10/14-VI-BG-NRH-35	For mounting the manifold block on H-rails according to EN 60715	51

Solenoid valves MHA2, fast-switching valves

Technical data – Sub-base valve, 5/2-way valve

Function

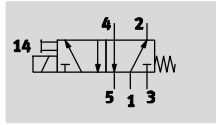

Voltage
24 V DC



Pressure
-0.9 ... +8 bar



Temperature range
-5 ... +40 °C



General technical data		
Valve function		5/2-way, single solenoid
Design		Pressure-relieved poppet valve
Sealing principle		Soft
Reset method		Mechanical spring
Actuation type		Electric
Type of control		Direct
Direction of flow		Reversible with restrictions ¹⁾
Exhaust air function		With flow control
Manual override		Non-detenting
Mounting position		Any
Width	[mm]	10
Grid dimension	[mm]	14
Nominal width	[mm]	2
Standard nominal flow rate	[l/min]	90
Type of mounting		On PR rail
Max. Tightening torque of valve mounting	[Nm]	0.4
Pneumatic connection		Sub-base
Product weight	[g]	70

1) Slight leakage can occur in the pressure range -0.8 bar to +0.5 bar.

Operating and environmental conditions		
Operating medium		Compressed air to ISO 8573-1:2010 [7:4:4]
Note on operating/pilot medium		Lubricated operation possible (in which case lubricated operation will always be required)
Operating pressure	[bar]	-0.9 ... +8
Ambient temperature	[°C]	-5 ... +40
Temperature of medium	[°C]	-5 ... +40
Restricted ambient and media temperature		As a function of switching frequency (see diagram)
Corrosion resistance class CRC ¹⁾		2
CE marking (see declaration of conformity)		To EU EMC Directive ²⁾
Approval certificate		cULus Recognized (OL) C-Tick

- 1) Corrosion resistance class 2 according to Festo standard 940 070
Components subject to moderate corrosion stress. Externally visible parts with primarily decorative surface requirements which are in direct contact with a normal industrial environment or media such as coolants or lubricating agents.
- 2) For information about the applicability of the component see the manufacturer's EC declaration of conformity at: www.festo.com/sp → User documentation.
If the component is subject to restrictions on usage in residential, office or commercial environments or small businesses, further measures to reduce the emitted interference may be necessary.

Solenoid valves MHA2, fast-switching valves

Technical data – Sub-base valve, 5/2-way valve

FESTO

Electrical data			
Electrical connection		2-pin plug or moulded-in cable	
Operating voltage		[V DC]	24 ±10%
Power consumption	Low-current phase	[W]	1.625
	High-current phase	[W]	6.5
Protection against incorrect polarity		Bipolar	
Additional functions		Spark arresting	
		Holding current reduction	
		Protective circuit	
Degree of protection to EN 60529	With moulded-in cable	IP65	
	With connecting cable KMYZ-3	IP65	
	With plug socket with cable KMYZ-4	IP50	
	With adapter VAVE-C8	IP65	

Response times and switching frequencies			
Switching time	On	[ms]	1.9 +10% ... -30%
	Off	[ms]	1.7 +10% ... -30%
Maximum switching frequency		[Hz]	300 ¹⁾
Switching time variation at 1 Hz and above		[ms]	0.2

1) The ambient temperature must be limited with frequencies in excess of 125 Hz.

Current curve for valves with fast-switching electronics (MHA2-MS1H)

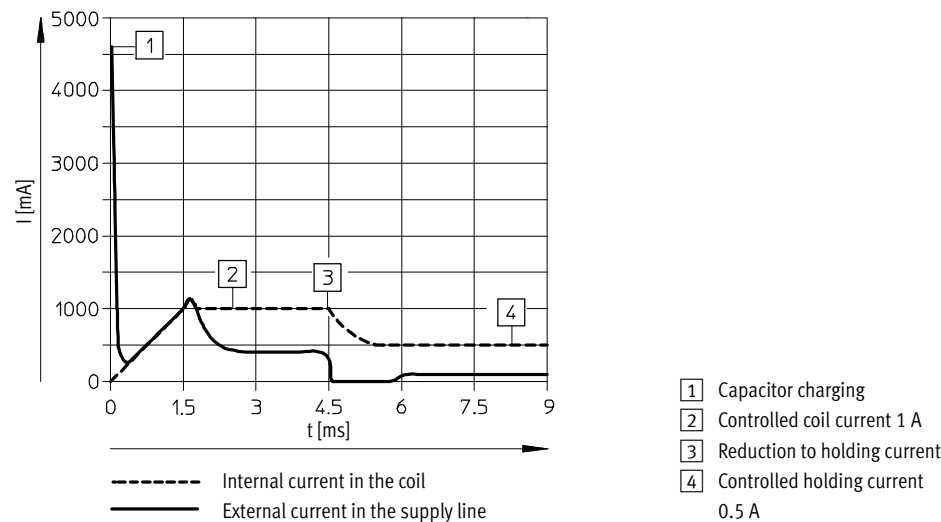

Solenoid valves MHA2, fast-switching valves

Technical data – Sub-base valve, 5/2-way valve

Materials

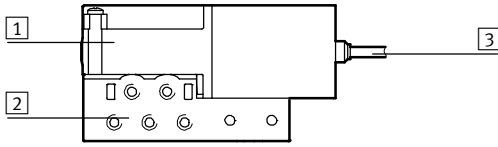

1	Housing	Die-cast zinc, coated
2	Sub-base	Die-cast zinc
3	Cable sheath	PUR
-	Seals	HNBR, NBR
-	Screws	Galvanised steel
Note on materials		Free of copper and PTFE RoHS-compliant

Dimensions

Download CAD data → www.festo.com

Valve with plug vanes or moulded-in cable, MHA2...-5/2...

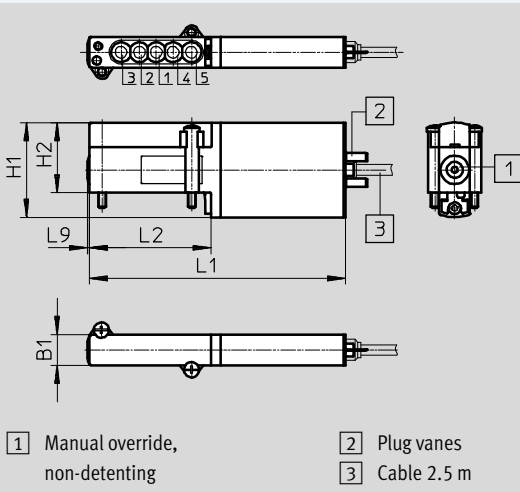

Hole pattern on sub-bases

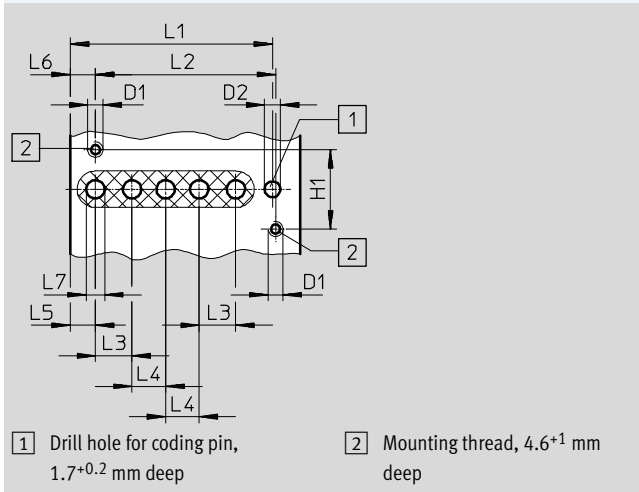

Type	B1	D1	D2 ∅	H1	H2	L1	L2	L3	L4	L5	L6	L7	L9
MHA2...-5/2...	10	-	-	31	23	84	40	-	-	-	-	-	0.5
Hole pattern	-	M2.5	2.6	13	-	33.1	29.5	6	5.5	4.1	4.1	3	-

Solenoid valves MHA2, fast-switching valves

Technical data – Sub-base valve, 5/2-way valve

Dimensions

Download CAD data → www.festo.com

Individual sub-base, MHA2-AS-5-M5

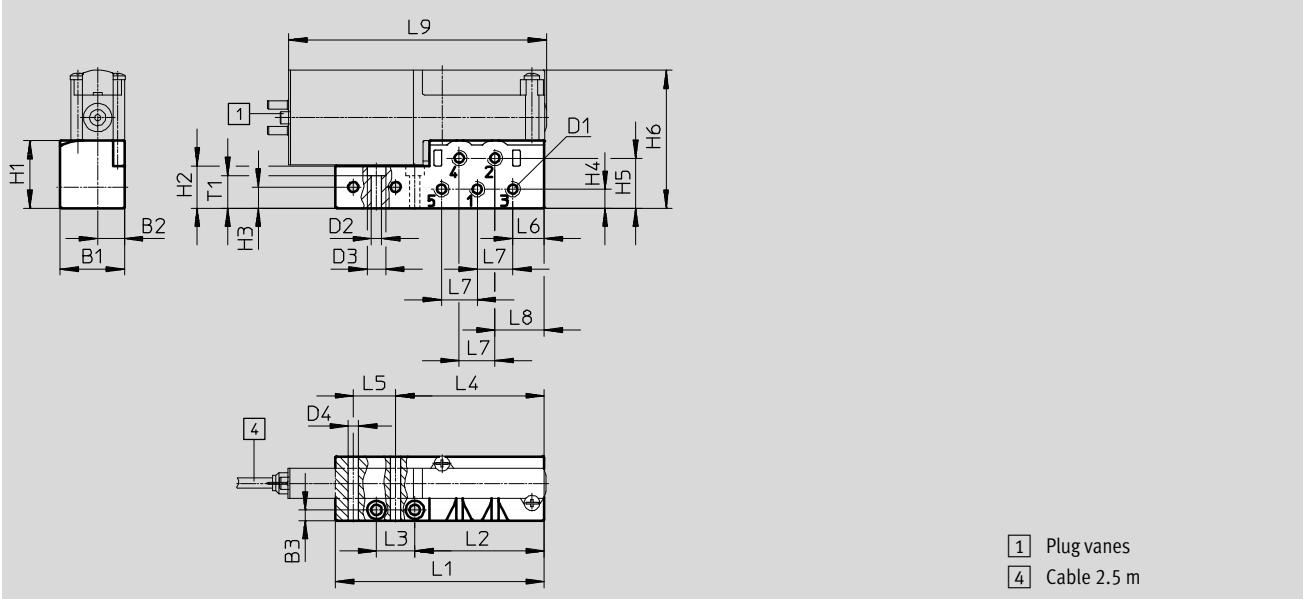

Type	B1	B2	B3	D1	D2	D3	D4	H1	H2	H3	H4	H5	H6
MHA2-AS-5-M5	21	8.8	3.5	M5	3.4	6	3.3	22.2	13.9	6.9	6.2	16.4	45.2

Type	L1	L2	L3	L4	L5	L6	L7	L8	L9	T1
MHA2-AS-5-M5	68.4	42.4	12.6	48.7	13.9	10.3	11.7	16.2	84.5	10.7

Solenoid valves MHA2, fast-switching valves

Technical data – Sub-base valve, 5/2-way valves

Dimensions

Download CAD data → www.festo.com

Manifold assembly, MHA2-PR...-5-M5

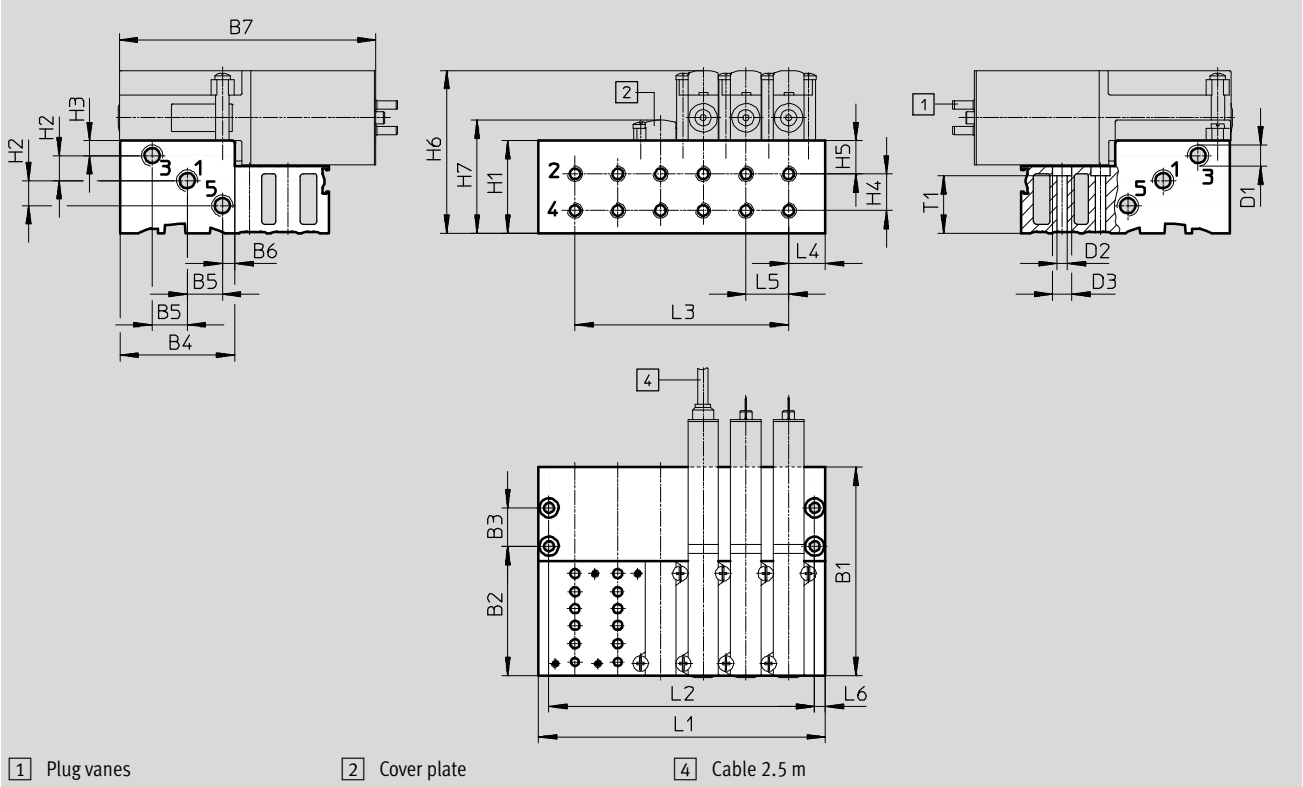





Type	B1	B2	B3	B4	B5	B6	B7	D1	D2	D3	H1	H2	H3	H4	H5	H6	H7	L4	L5	L6	T1
MHA2-PR...-5-M5	68.4	42.4	12.6	37.6	11.5	4.1	84	M7	3.3	6.3	30.3	8.2	4.9	12	10.9	53.3	37.1	12	14	3.5	18.8

Type		Number of valve positions				
		2	4	6	8	10
MHA2-PR...-5-M5	L1	38	66	94	122	150
	L2	31	59	87	115	143
	L3	14	42	70	98	126

Solenoid valves MHA2, fast-switching valves

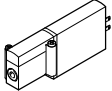
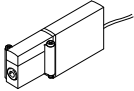

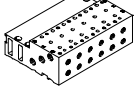

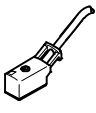
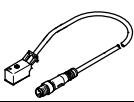

FESTO

Technical data – Sub-base valve, 5/2-way valve

Ordering data					Part No.	Type
Valves						
	Electrical connection: plug vanes	With fast-switching electronics, switching time 2 ms			525101	MHA2-MS1H-5/2-2
	Electrical connection: cable	With fast-switching electronics, switching time 2 ms			525103	MHA2-MS1H-5/2-2-K
Manifold rail						
	Individual sub-base Pneumatic connection: thread M5	1 valve position	525120	MHA2-AS-5-M5		
	Manifold block Pneumatic connection 1, 3, 5: thread M7 Pneumatic connection 2, 4: thread M5	2 valve positions	525127	MHA2-PR2-5-M5		
		4 valve positions	525128	MHA2-PR4-5-M5		
		6 valve positions	525129	MHA2-PR6-5-M5		
		8 valve positions	525130	MHA2-PR8-5-M5		
		10 valve positions	525131	MHA2-PR10-5-M5		
Cover plate						
	Vacant valve positions must be sealed with a cover plate				197470	MHAP2-BP-3
Connecting cable						
	2-pin socket, open cable end 2-wire	PUR cable, degree of protection IP65	Signal status display with LED	2.5 m long	193693	KMYZ-3-24-2,5-LED-PUR-B
				5 m long	193695	KMYZ-3-24-5-LED-PUR-B
				10 m long	196066	KMYZ-3-24-10-LED-PUR-B
		PVC cable, degree of protection IP50	Without signal status display	0.5 m long	193690	KMYZ-4-24-0,5-B
2.5 m long	193691			KMYZ-4-24-2,5-B		
	2-pin socket, plug M8x1 3-pin	PUR cable, degree of protection IP65	Signal status display with LED	0.5 m long	525654	KMYZ-3-24-M8-0,5-LED-PUR
				2.5 m long	525655	KMYZ-3-24-M8-2,5-LED-PUR

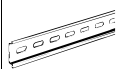
Solenoid valves MHA2, fast-switching valves

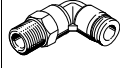
Technical data – Sub-base valve, 5/2-way valve

Ordering data				Part No.	Type
Adapter (for valves with plug vanes)					
	2-pin socket	Signal status display with LED	Plug M8, 3-pin	571686	VAVE-C8-1R8
			Plug M8, 4-pin	573194	VAVE-C8-1R1
H-rail mounting					
	For 5/2-way solenoid valves			162556	CPV10/14-VI-BG-NRH-35
H-rail					
	To EN 60715		2 m	35430	NRH-35-2000
Silencer Technical data → Internet: uc					
	With threaded connection	M5	1 piece	165003	UC-M5
			50 pieces	534217	UC-M5-50
		M7	1 piece	161418	UC-M7
			50 pieces	534218	UC-M7-50
Push-in fitting Technical data → Internet: qs					
	Male thread M5 with internal hex for tubing O.D.	4 mm	10 pieces	153315	QSM-M5-4-I
		6 mm	10 pieces	153317	QSM-M5-6-I
	Male thread M7 with internal hex for tubing O.D.	4 mm	10 pieces	153319	QSM-M7-4-I
			100 pieces	133006	QSM-M7-4-I-100
	Male thread M5 with external hex, push-in L-fitting rotatable through 360° for tubing O.D.	4 mm	10 pieces	153333	QSML-M5-4
			100 pieces	130771	QSML-M5-4-100
	6 mm	10 pieces	153335	QSML-M5-6	
		100 pieces	130772	QSML-M5-6-100	
	Male thread M7 with external hex, push-in L-fitting rotatable through 360° for tubing O.D.	4 mm	10 pieces	186352	QSML-M7-4
			100 pieces	130773	QSML-M7-4-100
6 mm	10 pieces	186353	QSML-M7-6		
		100 pieces	130774	QSML-M7-6-100	
Blanking plug					
	For thread M5		10 pieces	3843	B-M5
	For thread M7		10 pieces	174309	B-M7
Inscription label					
	For solenoid valve		80 pieces in frame	197259	MH-BZ-80X

Solenoid valves MH3, fast-switching valves

Type codes

MH E 3 - M S 1 H - 3/2 - G - QS6 K

Valve series	
MH	Fast-switching valves

Design	
E	Individual valve
P	Semi in-line valve
A	Sub-base valve

Size	
3	Flow rate 200 l/min

Drive system	
M	Solenoid, switching

Switching time	
-	8.3 ms
S	3 ms

Operating voltage	
1	24 V DC

Manual override	
H	Non-detenting

Valve function	
3/2	3/2-way valve

Normal position	
G	Closed
O	Open

Pneumatic connection	
3	Sub-base, nominal width 3 mm
1/8	Thread G1/8
QS-6	Push-in connector for tubing O.D. 6 mm

Electrical connection	
-	Plug vanes for plug socket KMYZ
K	Moulded-in cable, 2.5 m long

Solenoid valves MHE3, fast-switching valves

Peripherals overview – Individual valve

Connection with plug vanes – Connection with moulded-in cable

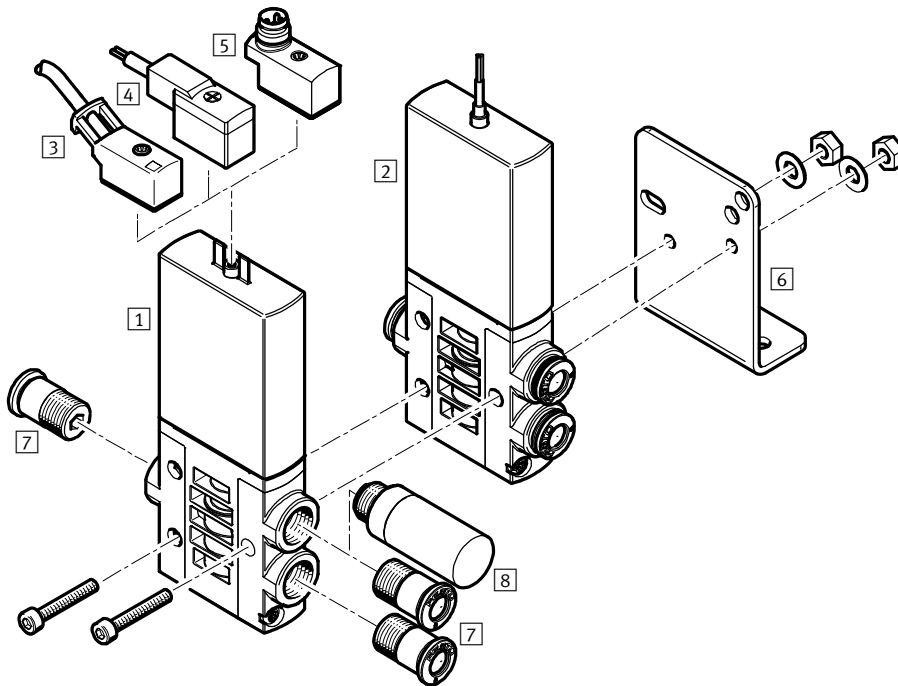

Designation	Brief description	→ Page/Internet
1 Individual valve MHE3	With plug vanes	58
2 Individual valve MHE3-...-K	With cable	58
3 Connecting cable KMYZ-3	PUR cable, signal status display with LED, IP65	59
4 Plug socket with cable KMYZ-4	PVC cable, without signal status display, IP50	59
5 Adapter VAVE-C8	For connecting the valves via connecting cable M8 3-pin or 4-pin, IP65	59
6 Mounting bracket MHE2-BG-L	For wall mounting	59
7 Push-in fittings QS	For connecting compressed air tubing with standard O.D.	59
8 Silencer UC	For mounting in exhaust ports	59

Solenoid valves MHE3, fast-switching valves

Technical data – Individual valve

FESTO

Function

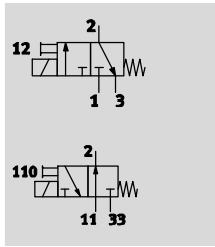

-  - Voltage
24 V DC

-  - Pressure
-0.9 ... +8 bar

-  - Temperature range
-5 ... +60 °C



General technical data		
Valve function		3/2 way, single solenoid ¹⁾
Design		Pressure-relieved poppet valve
Sealing principle		Soft
Reset method		Mechanical spring
Actuation type		Electric
Type of control		Direct
Direction of flow		Reversible with restrictions ²⁾
Exhaust air function		With flow control
Manual override		Non-detenting
Mounting position		Any
Width	[mm]	14
Grid dimension	[mm]	19 (minimum distance 5 mm)
Nominal width	[mm]	3
Standard nominal flow rate	[l/min]	200
Type of mounting		Via through-holes
Pneumatic connection		Connecting thread G ¹ / ₈
		Push-in connector for tubing O.D. 6 mm
Product weight	[g]	120

1) Can be used as a 2/2-way valve by sealing port 3 or 33

2) Slight leakage can occur in the pressure range -0.8 bar to +0.5 bar.

Operating and environmental conditions	With fast-switching electronics	Without fast-switching electronics
	Operating medium	Compressed air to ISO 8573-1:2010 [7:4:4]
Note on operating/pilot medium	Lubricated operation possible (in which case lubricated operation will always be required)	
Operating pressure	[bar]	-0.9 ... +8
Operating pressure, reversible	[bar]	-0.9
Ambient temperature	[°C]	-5 ... +60
Temperature of medium	[°C]	-5 ... +60
Restricted ambient and media temperature	As a function of switching frequency (see diagram)	
Corrosion resistance class CRC ¹⁾	2	
CE marking (see declaration of conformity)	To EU EMC Directive ²⁾	-
Certification	c UL us Recognized (OL)	c UL us Recognized (OL)
	C-Tick	-

1) Corrosion resistance class 2 according to Festo standard 940 070

Components subject to moderate corrosion stress. Externally visible parts with primarily decorative surface requirements which are in direct contact with a normal industrial environment or media such as coolants or lubricating agents.

2) For information about the applicability of the component see the manufacturer's EC declaration of conformity at: www.festo.com/sp → User documentation.

If the component is subject to restrictions on usage in residential, office or commercial environments or small businesses, further measures to reduce the emitted interference may be necessary.

Solenoid valves MHE3, fast-switching valves

Technical data – Individual valve

Electrical data		With fast-switching electronics	Without fast-switching electronics
Electrical connection		2-pin plug or moulded-in cable	
Operating voltage	[V DC]	24 ±10%	
Power consumption	[W]	6.5 for approx. 4.5 ms (high-current phase, pick-up current 1 A)	3.7
	[W]	1.6 (low-current phase)	–
Protection against incorrect polarity		Bipolar	–
Additional functions		Spark arresting	–
		Holding current reduction	–
		Protective circuit	–
Degree of protection to EN 60529	With moulded-in cable	IP65	IP65
	With connecting cable KMYZ-3	IP65	IP65
	With plug socket with cable KMYZ-4	IP50	IP50
	With adapter VAVE-C8	IP65	IP65

Response times and switching frequencies			With fast-switching electronics	Without fast-switching electronics
Switching time	On	[ms]	2.3 +10% ... -30%	8.3
	Off	[ms]	2.8 +10% ... -50%	4.5
Switching time variation at 1 Hz and above		[ms]	0.2	–
Maximum switching frequency		[Hz]	280 ¹⁾	130

1) The ambient temperature must be limited with frequencies in excess of 90 Hz.

Current curve for valves with fast-switching electronics (MHE3-MS1H)

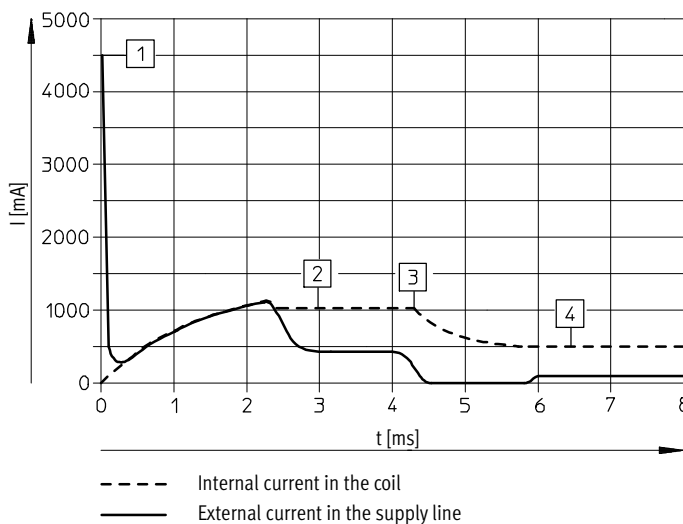

- 1 Capacitor charging
- 2 Controlled coil current 1 A
- 3 Reduction to holding current
- 4 Controlled holding current 0.5 A

Solenoid valves MHE3, fast-switching valves

Technical data – Individual valve



Materials

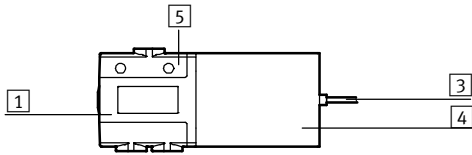

1	Housing	Die-cast zinc, coated
3	Cable sheath	Polyurethane
4	Coil housing	PA
5	Manifold rail	PA
-	Seals	HNBR, NBR
-	Screws	Galvanised steel
Note on materials		Free of copper and PTFE RoHS-compliant ¹⁾

1) Not RoHS-compliant: MHE3-M1H-3/20-QS6

Dimensions

Download CAD data → www.festo.com

Valve with plug vanes or moulded-in cable

MHE3-...-1/8-...

MHE3-...-QS6-...

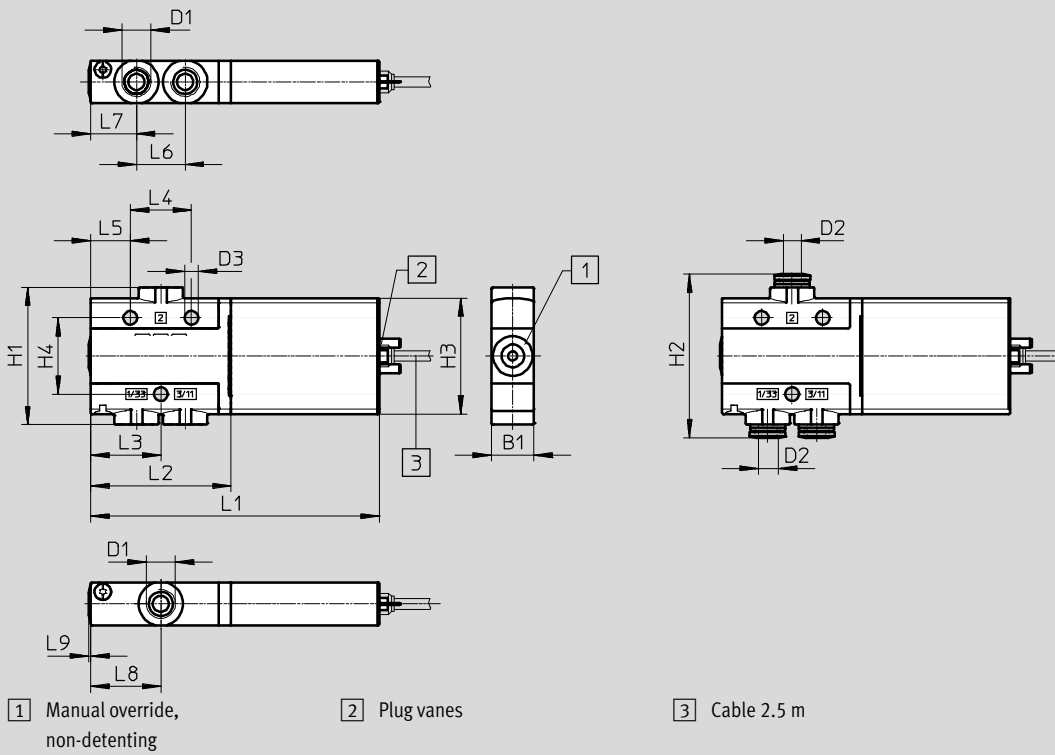

Type	B1	D1	D2 Ø	D3 Ø	H1	H2	H3	H4	L1	L2	L3	L4	L5	L6	L7	L8	L9
MHE3-...-1/8-...	14	G ¹ / ₈	-	4.5	45	-	38	25	94.5	46	23	20	13	16	15	23	0.6
MHE3-...-QS6-...	14	-	6	4.5	45	53.6	38	25	94.5	46	23	20	13	16	15	23	0.6

Solenoid valves MHE3, fast-switching valves

Technical data – Individual valve

Dimensions

Download CAD data → www.festo.com

Mounting bracket MHE2-BG-L



Type	B1	B2	B3	D1	H1	H2	L1	L2	L3
MHE2-BG-L	20	10	2	4.5	55	113.3	40	25	7.5

Solenoid valves MHE3, fast-switching valves



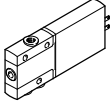
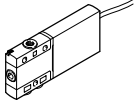

Technical data – Individual valve

Ordering data					Part No.	Type
Valves						
	Electrical connection: plug vanes	With fast-switching electronics, switching time 2.3 ms	Pneumatic connection: thread G $\frac{1}{8}$	Normally open	525167	MHE3-MS1H-3/20-1/8
				Normally closed	525147	MHE3-MS1H-3/2G-1/8
			Pneumatic connection: push-in connector for tubing O.D. 6 mm	Normally open	525171	MHE3-MS1H-3/20-QS6
				Normally closed	525151	MHE3-MS1H-3/2G-QS6
		Without fast-switching electronics, switching time 8.3 ms	Pneumatic connection: thread G $\frac{1}{8}$	Normally open	525166	MHE3-M1H-3/20-1/8
				Normally closed	525146	MHE3-M1H-3/2G-1/8
			Pneumatic connection: push-in connector for tubing O.D. 6 mm	Normally open	525170	MHE3-M1H-3/20-QS6 ¹⁾
				Normally closed	525150	MHE3-M1H-3/2G-QS6
	Electrical connection: cable	With fast-switching electronics, switching time 2.3 ms	Pneumatic connection: thread G $\frac{1}{8}$	Normally open	525169	MHE3-MS1H-3/20-1/8-K
				Normally closed	525149	MHE3-MS1H-3/2G-1/8-K
			Pneumatic connection: push-in connector for tubing O.D. 6 mm	Normally closed	525153	MHE3-MS1H-3/2G-QS6-K
				Without fast-switching electronics, switching time 8.3 ms	Pneumatic connection: thread G $\frac{1}{8}$	Normally open
		Normally closed	525148			MHE3-M1H-3/2G-1/8-K
		Pneumatic connection: push-in connector for tubing O.D. 6 mm	Normally closed		525152	MHE3-M1H-3/2G-QS6-K

1) Not RoHS-compliant

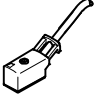
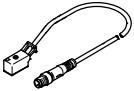
Solenoid valves MHE3, fast-switching valves

Technical data – Individual valve

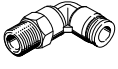
Ordering data					Part No.	Type
Connecting cable (for valves with plug vanes)						
	2-pin socket, open cable end 2-wire	PUR cable, degree of protection IP65	Signal status display with LED	Length: 2.5 m	193693	KMYZ-3-24-2,5-LED-PUR-B
				Length: 5 m	193695	KMYZ-3-24-5-LED-PUR-B
				Length: 10 m	196066	KMYZ-3-24-10-LED-PUR-B
	2-pin socket, plug M8x1 3-pin	PVC cable, degree of protection IP50	Without signal status display	Length: 0.5 m	193690	KMYZ-4-24-0,5-B
				Length: 2.5 m	193691	KMYZ-4-24-2,5-B
				Length: 0.5 m	525654	KMYZ-3-24-M8-0,5-LED-PUR
				Length: 2.5 m	525655	KMYZ-3-24-M8-2,5-LED-PUR
Adapter (for valves with plug vanes)						
	2-pin socket	Signal status display with LED	Plug M8, 3-pin	571686	VAVE-C8-1R8	
			Plug M8, 4-pin	573194	VAVE-C8-1R1	
Wall mounting						
	Mounting bracket				196165	MHE2-BG-L
Silencer Technical data → Internet: uc						
	Push-in sleeve with O.D. 6 mm			1 piece	165007	UC-QS-6H
	With threaded connection G1/8			1 piece	161419	UC-1/8
				50 pieces	534219	UC-1/8-50
Push-in fitting Technical data → Internet: qs						
	Male thread G1/8 with external hex for tubing O.D.	6 mm	10 pieces	186096	QS-G1/8-6	
			100 pieces	132037	QS-G1/8-6-100	
			10 pieces	186098	QS-G1/8-8	
			50 pieces	132038	QS-G1/8-8-50	
	Male thread G1/8 with external hex, push-in L-fitting rotatable through 360° for tubing O.D.	6 mm	10 pieces	186117	QSL-G1/8-6	
			100 pieces	132049	QSL-G1/8-6-100	
			10 pieces	186119	QSL-G1/8-8	
			50 pieces	132050	QSL-G1/8-8-50	

Solenoid valves MHP3, fast-switching valves

Peripherals overview – Semi in-line valve

Connection with plug vanes – Connection with moulded-in cable

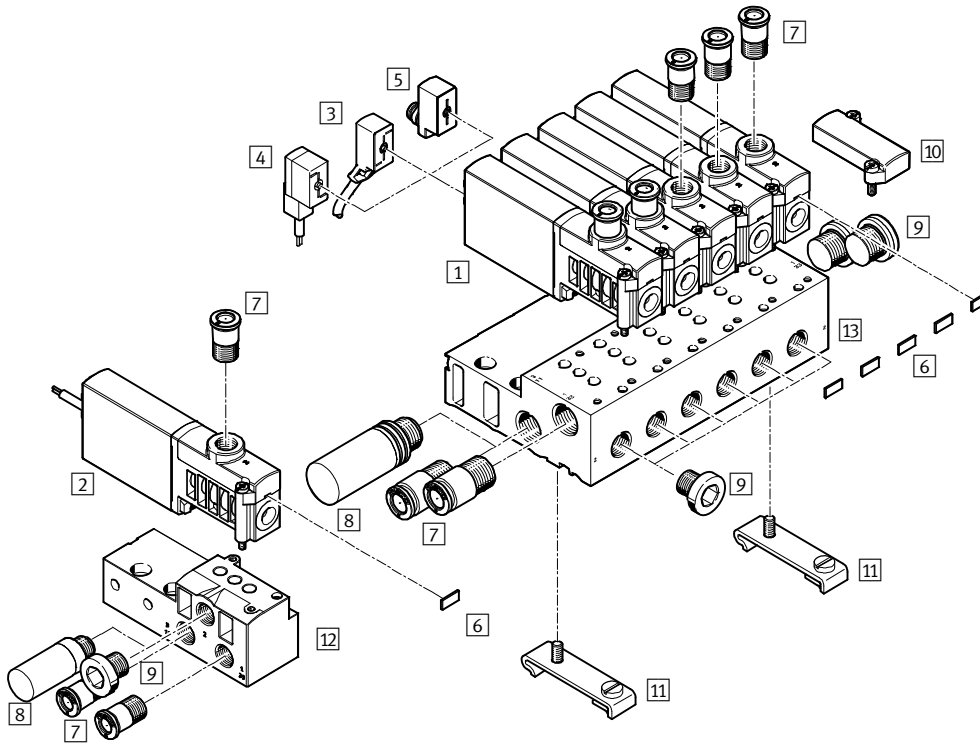





Designation	Brief description	→ Page/Internet
1 Semi in-line valve MHP3	With plug vanes	66
2 Semi in-line valve MHP3-...-K	With cable	66
3 Connecting cable KMYZ-3	PUR cable, switching signal display with LED, IP65	66
4 Plug socket with cable KMYZ-4	PVC cable, without signal status display, IP50	66
5 Adapter VAVE-C8	For connecting the valves via connecting cable M8 3-pin or 4-pin, IP65	66
6 Inscription label MH-BZ-80X	For identifying the valves	67
7 Push-in fittings QS	For connecting compressed air tubing with standard O.D.	67
8 Silencer UC	For mounting in exhaust ports	67
9 Blanking plug B	For sealing unused ports	67
10 Cover plate MHAP3-BP-3	For sealing vacant positions	66
11 H-rail mounting CPV10/14-VI-BG-NRH-35	For mounting the manifold block on H-rails according to EN 60715	67
12 Individual sub-base MHA3-AS-3-1/8	For semi in-line valves; the individual sub-base is also used for sub-base valves and must be sealed with a blanking plug here	66
13 Manifold block MHA3-PR	For semi in-line valves	66

Solenoid valves MHP3, fast-switching valves

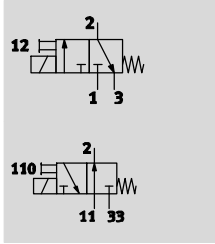
Technical data – Semi in-line valve

Function



-  Voltage
24 V DC
-  Pressure
-0.9 ... +8 bar
-  Temperature range
-5 ... +40 °C



General technical data		
Valve function		3/2 way, single solenoid ¹⁾
Design		Pressure-relieved poppet valve
Sealing principle		Soft
Reset method		Mechanical spring
Actuation type		Electric
Type of control		Direct
Direction of flow		Reversible with restrictions ²⁾
Exhaust air function		With flow control
Manual override		Non-detenting
Mounting position		Any
Width	[mm]	14
Grid dimension	[mm]	19
Nominal width	[mm]	3
Standard nominal flow rate	[l/min]	200
Type of mounting		On PR rail
Pneumatic connection	2 1, 11, 3, 33, 5	Connecting thread G1/8, push-in connector for tubing O.D. 6 mm Sub-base
Product weight	[g]	120

- 1) Can be used as a 2/2-way valve by sealing port 3 or 33
- 2) Slight leakage can occur in the pressure range -0.8 bar to +0.5 bar.

Operating and environmental conditions		
	With fast-switching electronics	Without fast-switching electronics
Operating medium	Compressed air to ISO 8573-1:2010 [7:4:4]	
Note on operating/pilot medium	Lubricated operation possible (in which case lubricated operation will always be required)	
Operating pressure	[bar]	-0.9 ... +8
Operating pressure, reversible	[bar]	-0.9
Ambient temperature	[°C]	-5 ... +40
Temperature of medium	[°C]	-5 ... +40
Restricted ambient and media temperature	As a function of switching frequency (see diagram)	
Corrosion resistance class CRC ¹⁾	2	
CE marking (see declaration of conformity)	To EU EMC Directive ²⁾	-
Certification	c UL us Recognized (OL) C-Tick	c UL us Recognized (OL) -

- 1) Corrosion resistance class 2 according to Festo standard 940 070
Components subject to moderate corrosion stress. Externally visible parts with primarily decorative surface requirements which are in direct contact with a normal industrial environment or media such as coolants or lubricating agents.
- 2) For information about the applicability of the component see the manufacturer's EC declaration of conformity at: www.festo.com/sp → User documentation.
If the component is subject to restrictions on usage in residential, office or commercial environments or small businesses, further measures to reduce the emitted interference may be necessary.

Solenoid valves MHP3, fast-switching valves

Technical data – Semi in-line valve

Electrical data		With fast-switching electronics	Without fast-switching electronics
Electrical connection		2-pin plug or moulded-in cable	
Operating voltage	[V DC]	24 ±10%	
Power consumption	[W]	6.5 for approx. 4.5 ms (high-current phase, pick-up current 1 A)	3.7
	[W]	1.6 (low-current phase)	–
Protection against incorrect polarity		Bipolar	–
Additional functions		Spark arresting	–
		Holding current reduction	–
		Protective circuit	–
Degree of protection to EN 60529	With moulded-in cable	IP65	IP65
	With connecting cable KMYZ-3	IP65	IP65
	With plug socket with cable KMYZ-4	IP50	IP50
	With adapter VAVE-C8	IP65	IP65

Response times and switching frequencies			
		With fast-switching electronics	Without fast-switching electronics
Switching time	On [ms]	2.3 +10% ... -30%	8.3
	Off [ms]	2.8 +10% ... -50%	4.5
Switching time variation at 1 Hz and above	[ms]	0.2	–
Maximum switching frequency	[Hz]	280 ¹⁾	130

1) The ambient temperature must be limited with frequencies in excess of 100 Hz.

Current curve for valves with fast-switching electronics (MHP3-MS1H)

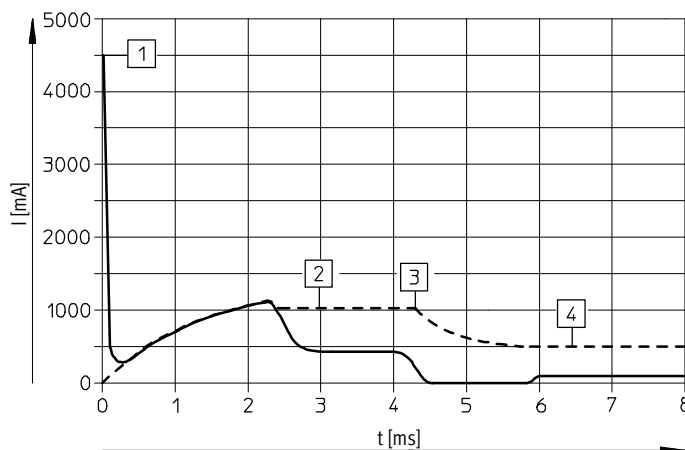

----- Internal current in the coil
 ——— External current in the supply line

- 1) Capacitor charging
- 2) Controlled coil current 1 A
- 3) Reduction to holding current
- 4) Controlled holding current 0.5 A

Solenoid valves MHP3, fast-switching valves

Technical data – Semi in-line valve

Materials

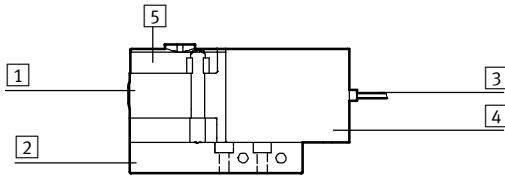

1	Housing	Die-cast zinc, coated
2	Sub-base	Aluminium in the case of the manifold, die-cast zinc in the case of individual sub-base
3	Cable sheath	PUR
4	Coil housing	PA
5	Manifold rail	PA
-	Seals	HNBR, NBR
-	Screws	Galvanised steel
Note on materials		Free of copper and PTFE RoHS-compliant

Dimensions

Download CAD data → www.festo.com

Valve with connecting thread G1/8

Valve with push-in connector for tubing O.D. 6 mm

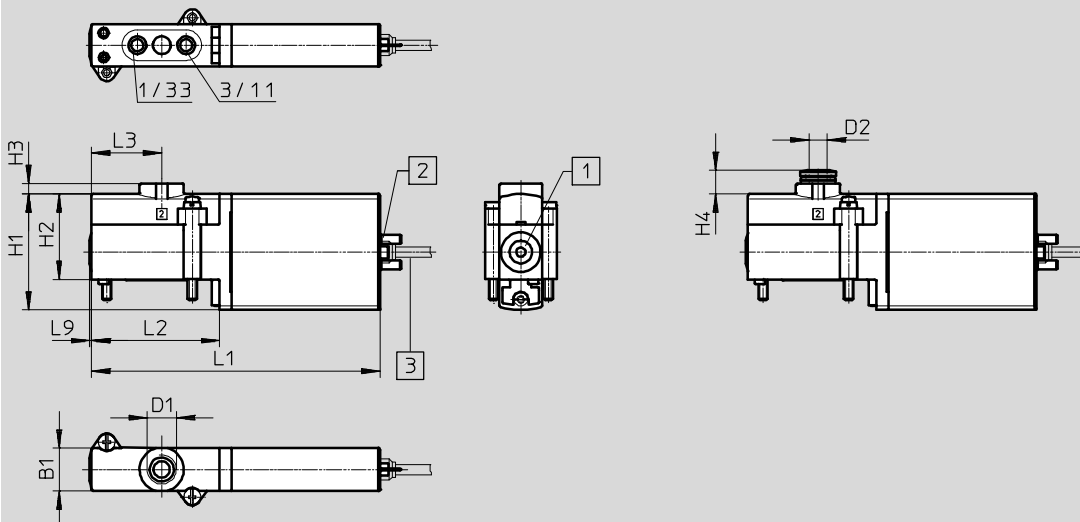

- 1 Manual override, non-detenting
- 2 Plug vanes
- 3 Cable 2.5 m

Type	B1	D1	D2 ∅	H1	H2	H3	H4	L1	L2	L3	L9
MHP3-...-3/2...	14	G1/8	6	38	28	3.5	7.8	94.5	42	23	0.6

Solenoid valves MHP3, fast-switching valves

Technical data – Semi in-line valve



Dimensions

Download CAD data → www.festo.com

Hole pattern on sub-bases

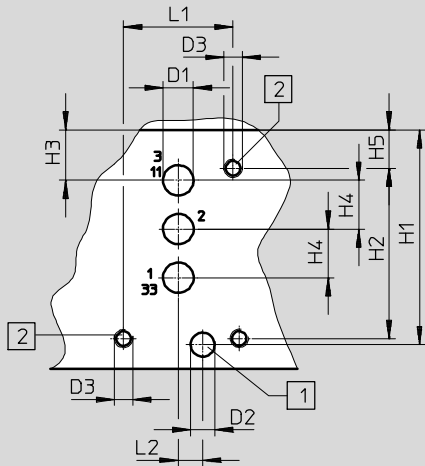

- 1 Drill hole for coding pin, 2 mm deep
- 2 Mounting thread, 8 mm deep



Note

With semi in-line valves, port 2 is not used.

If used as a 2/2-way valve, normally closed, ports 3/11 are not used.

If used as a 2/2-way valve, normally open, ports 1/33 are not used.

Individual sub-base, MHA3-AS-3-1/8

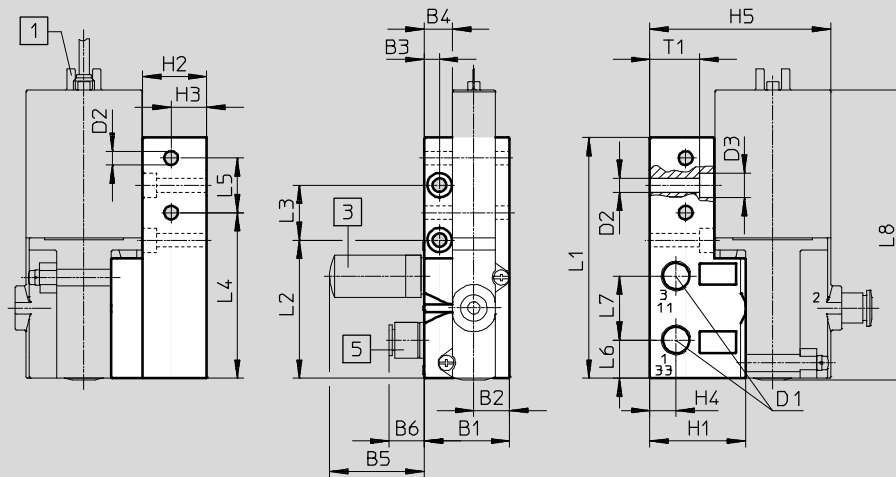

- 1 Plug vanes
- 3 Silencer
- 5 Push-in fitting

Type	B1	B2	B3	B4	B5	B6	D1	D2	D3	H1	H2	H3	H4	H5
Hole pattern	-	-	-	-	-	-	5	4	M3	35.3	28	8.3	8	6.3
MHA3-AS-3-1/8	28	11.8	5	9.3	31.5	13.3	G1/8	4.5	8	31.3	21	11.7	8.6	59.3

Type	L1	L2	L3	L4	L5	L6	L7	L8	T1
Hole pattern	18	4	-	-	-	-	-	-	-
MHA3-AS-3-1/8	78.9	45.3	18	54.3	17.9	12.5	21	95	16.4

Solenoid valves MHP3, fast-switching valves

Technical data – Semi in-line valve

Dimensions

Download CAD data → www.festo.com

Manifold assembly, MHA3-PR...-1/8

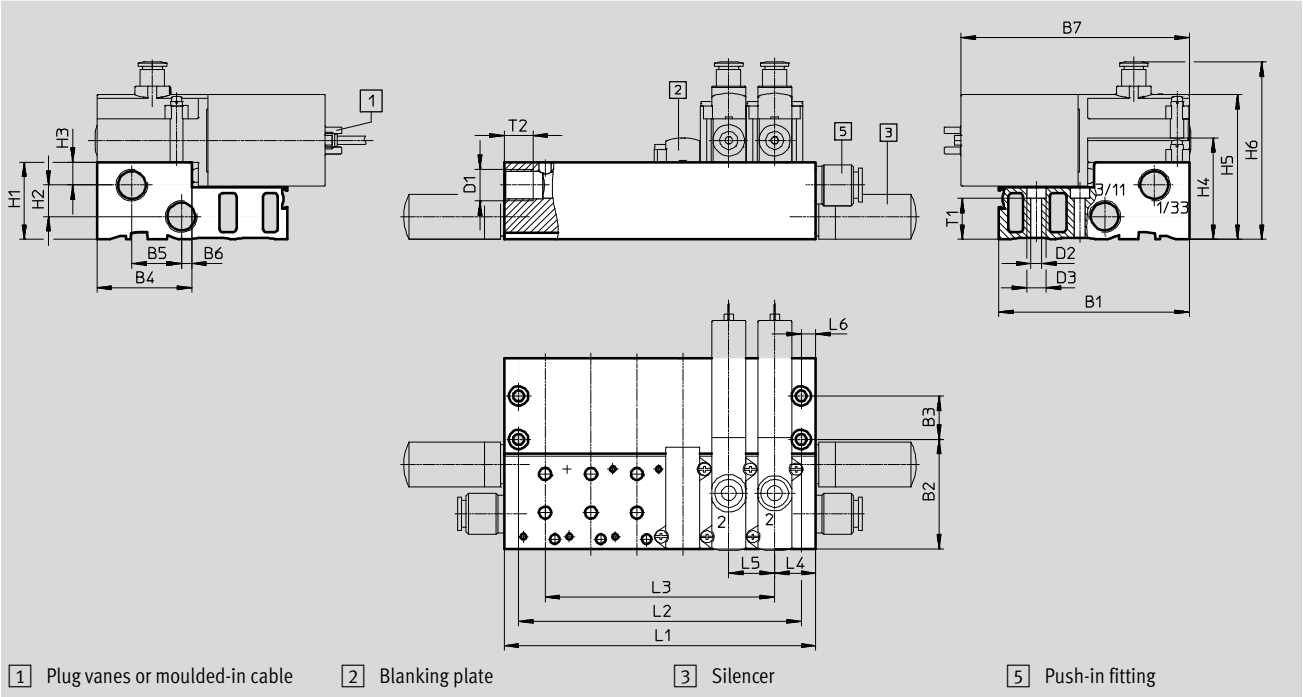

H-rail mounting CPV10/14-VI-BG-NRH-35

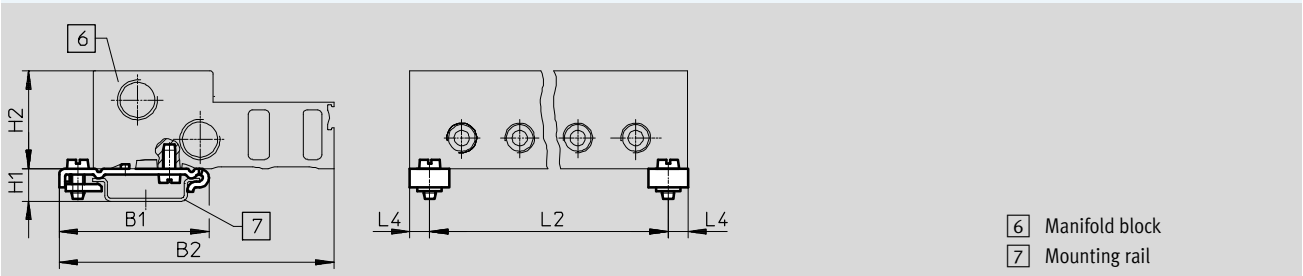

Type	B1	B2	B3	B4	B5	B6	B7	D1	D2 Ø	D3 Ø	H1	H2	H3	H4	H5	H6	L4	L5	L6	T1	T2
MHA3-PR...-1/8	79	45.3	18	39.3	20.5	4.3	94.5	G¼	4.5	8	32	13	9.5	42	60	73.5	17	19	6	17.1	12
CPV10/14-VI-BG...	49.1	90	-	-	-	-	-	-	-	-	10.7	32	-	-	-	-	6.5	-	-	-	-







Type		Number of valve positions				
		2	4	6	8	10
MHA3-PR...-1/8	L1	53	91	129	167	205
	L2	41	79	117	155	193
	L3	19	57	95	133	171
CPV10/14-VI-BG...	L2	40	78	116	154	192

- - Note
Valve types 3/2G and 3/2O must not be mixed on a manifold block.

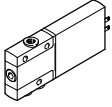
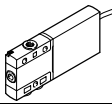
Solenoid valves MHP3, fast-switching valves

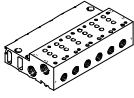
FESTO

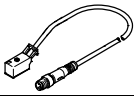
Technical data – Semi in-line valve







Ordering data					Part No.	Type
Valves						
	Electrical connection: plug vanes	With fast-switching electronics, switching time 2.3 ms	Pneumatic connection: thread G1/8	Normally open	525159	MHP3-MS1H-3/20-1/8
				Normally closed	525139	MHP3-MS1H-3/2G-1/8
			Pneumatic connection: push-in connector for tubing O.D. 6 mm	Normally closed	525143	MHP3-MS1H-3/2G-QS6
		Without fast-switching electronics, switching time 8.3 ms	Pneumatic connection: thread G1/8	Normally open	525158	MHP3-M1H-3/20-1/8
				Normally closed	525138	MHP3-M1H-3/2G-1/8
			Pneumatic connection: push-in connector for tubing O.D. 6 mm	Normally closed	525142	MHP3-M1H-3/2G-QS6
	Electrical connection: cable	With fast-switching electronics, switching time 2.3 ms	Pneumatic connection: push-in connector for tubing O.D. 6 mm	Normally closed	525145	MHP3-MS1H-3/2G-QS6-K
Manifold rail						
	Individual sub-base ¹⁾ Pneumatic connection: thread G1/8			1 valve position	525214	MHA3-AS-3-1/8
	Manifold block ¹⁾ Pneumatic connection 1, 11, 3, 33: thread G1/4 Pneumatic connection 2: thread G1/8			2 valve positions	525221	MHA3-PR2-3-1/8
				4 valve positions	525222	MHA3-PR4-3-1/8
				6 valve positions	525223	MHA3-PR6-3-1/8
				8 valve positions	525224	MHA3-PR8-3-1/8
				10 valve positions	525225	MHA3-PR10-3-1/8
Cover plate						
	Vacant valve positions must be sealed with a cover plate				525226	MHAP3-BP-3
Connecting cable (for valves with plug vanes)						
	2-pin socket, open cable end 2-wire	PUR cable, degree of protection IP65	Signal status display with LED	2.5 m long	193693	KMYZ-3-24-2,5-LED-PUR-B
				5 m long	193695	KMYZ-3-24-5-LED-PUR-B
				10 m long	196066	KMYZ-3-24-10-LED-PUR-B
	2-pin socket, plug M8x1 3-pin	PVC cable, degree of protection IP50	Without signal status display	0.5 m long	193690	KMYZ-4-24-0,5-B
				2.5 m long	193691	KMYZ-4-24-2,5-B
				0.5 m long	525654	KMYZ-3-24-M8-0,5-LED-PUR
2.5 m long	525655	KMYZ-3-24-M8-2,5-LED-PUR				
Adapter (for valves with plug vanes)						
	2-pin socket	Signal status display with LED	Plug M8, 3-pin	571686	VAVE-C8-1R8	
			Plug M8, 4-pin	573194	VAVE-C8-1R1	

1) Seal port 2 with a blanking plug. These ports have no function when using semi in-line valves.

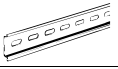
Solenoid valves MHP3, fast-switching valves

FESTO

Technical data – Semi in-line valve

Ordering data				Part No.	Type
H-rail mounting					
	For manifold block			162556	CPV10/14-VI-BG-NRH-35
H-rail					
	To EN 60715	2 m		35430	NRH-35-2000
Silencer Technical data → Internet: uc					
	Push-in sleeve with O.D. 6 mm		1 piece	165007	UC-QS-6H
	With threaded connection	G ¹ / ₈	1 piece	161419	UC-1/8
			50 pieces	534219	UC-1/8-50
		G ¹ / ₄	1 piece	165004	UC-1/4
	20 pieces		534220	UC-1/4-20	
Push-in fitting Technical data → Internet: qs					
	Male thread G ¹ / ₈ with external hex for tubing O.D.	6 mm	10 pieces	186096	QS-G1/8-6
			100 pieces	132037	QS-G1/8-6-100
		8 mm	10 pieces	186098	QS-G1/8-8
	50 pieces		132038	QS-G1/8-8-50	
	Male thread G ¹ / ₄ with external hex for tubing O.D.		8 mm	10 pieces	186099
		50 pieces		132040	QS-G1/4-8-50
10 mm		10 pieces	186101	QS-G1/4-10	
	Male thread G ¹ / ₈ with external hex, push-in L-fitting rotatable through 360° for tubing O.D.	6 mm	10 pieces	186117	QSL-G1/8-6
			100 pieces	132049	QSL-G1/8-6-100
		8 mm	10 pieces	186119	QSL-G1/8-8
	50 pieces		132050	QSL-G1/8-8-50	
	Male thread G ¹ / ₄ with external hex, push-in L-fitting rotatable through 360° for tubing O.D.	8 mm	10 pieces	186120	QSL-G1/4-8
			50 pieces	132052	QSL-G1/4-8-50
		10 mm	10 pieces	186122	QSL-G1/4-10
50 pieces	132053		QSL-G1/4-10-50		
Blanking plug					
	For thread G ¹ / ₈		10 pieces	3568	B-1/8
	For thread G ¹ / ₄		10 pieces	3569	B-1/4
Inscription label					
	For solenoid valve		80 pieces in frame	197259	MH-BZ-80X

Solenoid valves MHA3, fast-switching valves

Peripherals overview – Sub-base valve

Connection with plug vanes – Connection with moulded-in cable

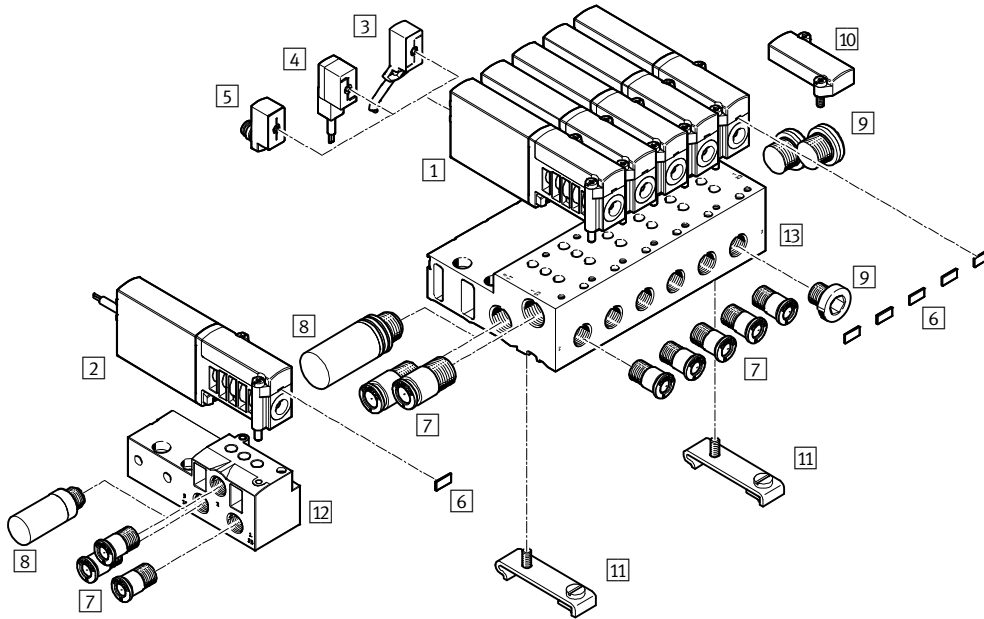

Designation	Brief description	→ Page/Internet
1 Sub-base valve MHA3	With plug vanes	74
2 Sub-base valve MHA3-...-K	With cable	74
3 Connecting cable KMYZ-3	PUR cable, signal status display with LED, IP65	74
4 Plug socket with cable KMYZ-4	PVC cable, without signal status display, IP50	74
5 Adapter VAVE-C8	For connecting the valves via connecting cable M8 3-pin or 4-pin, IP65	74
6 Inscription label MH-BZ-80X	For identifying the valves	75
7 Push-in fittings QS	For connecting compressed air tubing with standard O.D.	75
8 Silencer UC	For mounting in exhaust ports	75
9 Blanking plug B	For sealing unused ports	75
10 Cover plate MHAP3-BP-3	For sealing vacant positions	74
11 H-rail mounting CPV10/14-VI-BG-NRH-35	For mounting the manifold block on H-rails according to EN 60715	75
12 Individual sub-base MHA3-AS-3-1/8	For sub-base valve	74
13 Manifold block MHA3-PR...-3-1/8	For sub-base valve	74



Solenoid valves MHA3, fast-switching valves

FESTO

Technical data – Sub-base valve

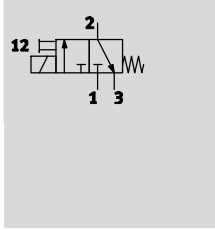
Function



-  Voltage
24 V DC
-  Pressure
-0.9 ... +8 bar
-  Temperature range
-5 ... +40 °C



General technical data	
Valve function	3/2 way, single solenoid ¹⁾
Design	Pressure-relieved poppet valve
Sealing principle	Soft
Reset method	Mechanical spring
Actuation type	Electric
Type of control	Direct
Direction of flow	Reversible with restrictions ²⁾
Exhaust air function	With flow control
Manual override	Non-detenting
Mounting position	Any
Width	[mm] 14
Grid dimension	[mm] 19
Nominal width	[mm] 3
Standard nominal flow rate	[l/min] 200
Type of mounting	On PR rail, via through-hole
Pneumatic connection	Sub-base
Product weight	[g] 120

- 1) Can be used as a 2/2-way valve by sealing port 3 or 33
- 2) Slight leakage can occur in the pressure range -0.8 bar to +0.5 bar.

Operating and environmental conditions		With fast-switching electronics	Without fast-switching electronics
Operating medium		Compressed air to ISO 8573-1:2010 [7:4:4]	
Note on operating/pilot medium		Lubricated operation possible (in which case lubricated operation will always be required)	
Operating pressure	[bar]	-0.9 ... +8	
Ambient temperature	[°C]	-5 ... +40	
Temperature of medium	[°C]	-5 ... +40	
Restricted ambient and media temperature		As a function of switching frequency (see diagram)	
Corrosion resistance class CRC ¹⁾		2	
CE marking (see declaration of conformity)		To EU EMC Directive ²⁾	-
Certification		c UL us Recognized (OL)	c UL us Recognized (OL)
		C-Tick	-

- 1) Corrosion resistance class 2 according to Festo standard 940 070
Components subject to moderate corrosion stress. Externally visible parts with primarily decorative surface requirements which are in direct contact with a normal industrial environment or media such as coolants or lubricating agents.
- 2) For information about the applicability of the component see the manufacturer's EC declaration of conformity at: www.festo.com/sp → User documentation.
If the component is subject to restrictions on usage in residential, office or commercial environments or small businesses, further measures to reduce the emitted interference may be necessary.

Solenoid valves MHA3, fast-switching valves

Technical data – Sub-base valve

Electrical data		With fast-switching electronics	Without fast-switching electronics
Electrical connection		2-pin plug or moulded-in cable	
Operating voltage	[V DC]	24 ±10%	
Power consumption	[W]	6.5 for approx. 4.5 ms (high-current phase, pick-up current 1 A)	3.7
	[W]	1.6 (low-current phase)	–
Protection against incorrect polarity		Bipolar	–
Additional functions		Spark arresting	–
		Holding current reduction	–
		Protective circuit	–
Degree of protection to EN 60529	With moulded-in cable	IP65	IP65
	With connecting cable KMYZ-3	IP65	IP65
	With plug socket with cable KMYZ-4	IP50	IP50
	With adapter VAVE-C8	IP65	IP65

Response times and switching frequencies				With fast-switching electronics	Without fast-switching electronics
Switching time	On	[ms]	2.3 +10% ... -30%	8.3	
	Off	[ms]	2.8 +10% ... -30%	4.5	
Switching time variation at 1 Hz and above		[ms]	0.2	–	
Maximum switching frequency		[Hz]	280 ¹⁾	130	

1) The ambient temperature must be limited with frequencies in excess of 100 Hz.

Current curve for valves with fast-switching electronics (MHA3-MS1H)

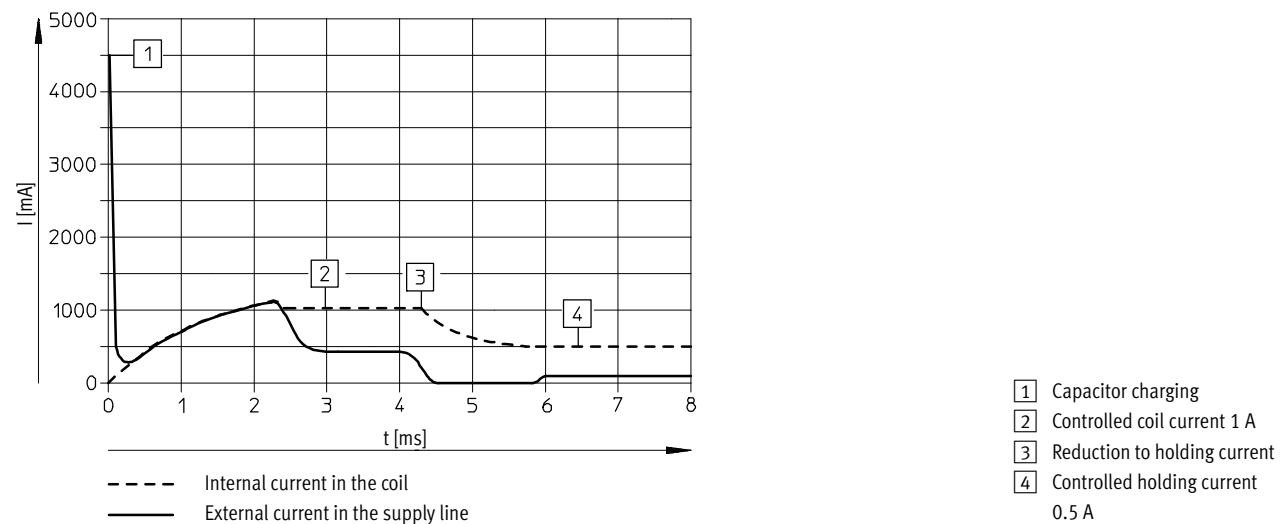

Solenoid valves MHA3, fast-switching valves

Technical data – Sub-base valve

Materials

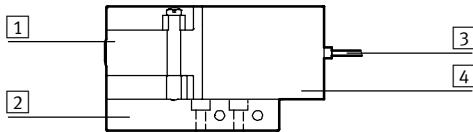

1	Housing	Die-cast zinc, coated
2	Sub-base	Aluminium in the case of the manifold, die-cast zinc in the case of the individual sub-base
3	Cable sheath	PUR
4	Coil housing	PA
-	Seals	HNBR, NBR
-	Screws	Galvanised steel
Note on materials		Free of copper and PTFE RoHS-compliant

Dimensions

Download CAD data → www.festo.com

Valve with plug vanes or moulded-in cable, MHA3-...-3/2G...

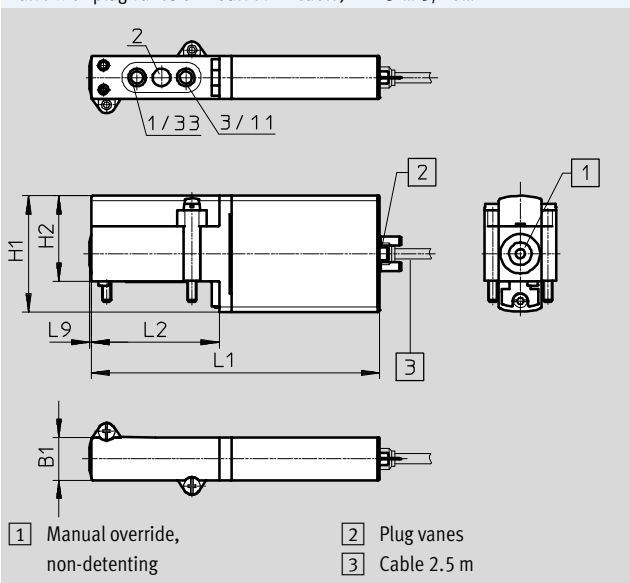

Hole pattern on sub-bases

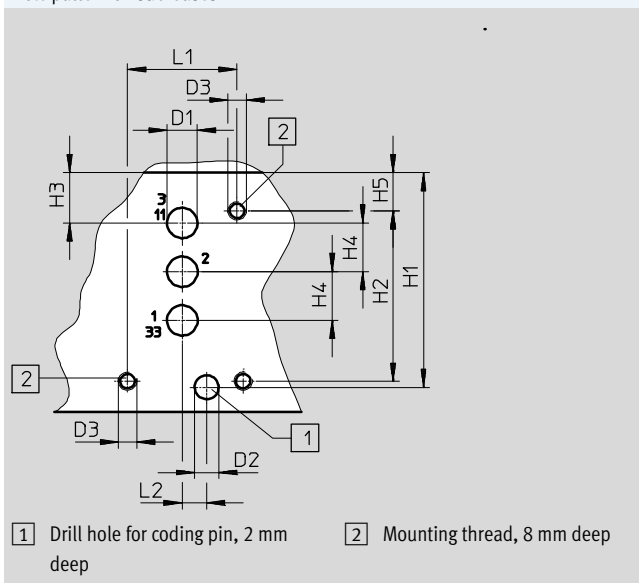

Type	B1	D1	D2 ∅	D3 ∅	H1	H2	H3	H4	H5	L1	L2	L9
MHA3-...-3/2G...	14	-	-	-	38	28	-	-	-	94.5	42	0.6
Hole pattern	-	5	4	M3	35.3	28	8.3	8	6.3	18	4	-

Solenoid valves MHA3, fast-switching valves

Technical data – Sub-base valve

Dimensions

Download CAD data → www.festo.com

Individual sub-base, MHA3-AS-3-1/8

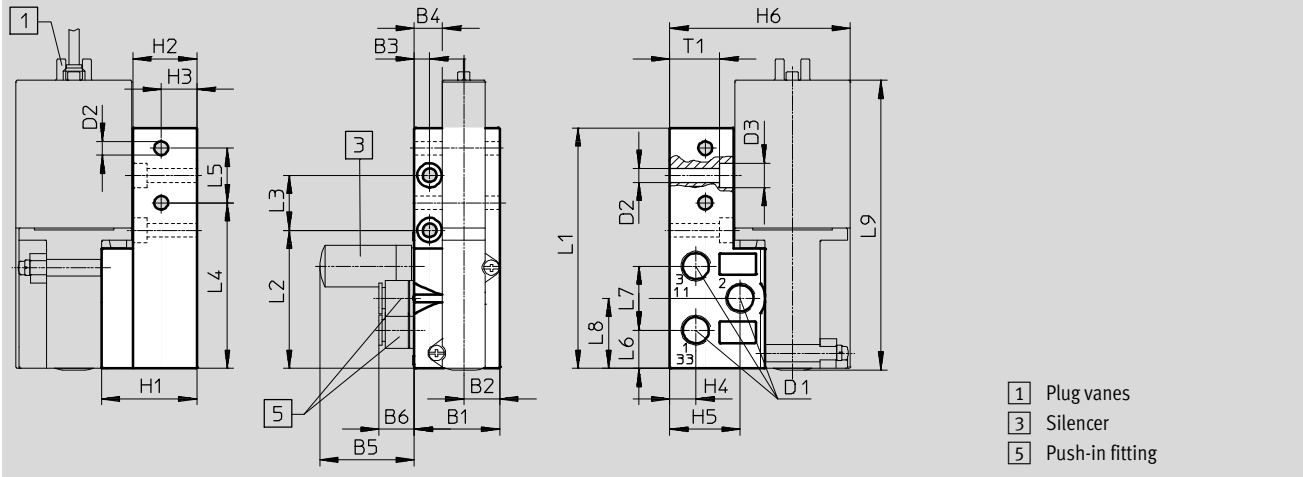

Type	B1	B2	B3	B4	B5	B6	D1	D2 ∅	D3 ∅	H1	H2	H3	H4	H5	H6
MHA3-AS-3-1/8	28	11.8	5	9.3	31.5	13.3	G1/8	4.5	8	31.3	21	11.7	8.6	23.2	59.3

Type	L1	L2	L3	L4	L5	L6	L7	L8	L9	T1
MHA3-AS-3-1/8	78.9	45.3	18	54.3	17.9	12.5	21	23	95	16.4

Solenoid valves MHA3, fast-switching valves

Technical data – Sub-base valve

Dimensions

Download CAD data → www.festo.com

Manifold assembly, MHA3-PR...-1/8

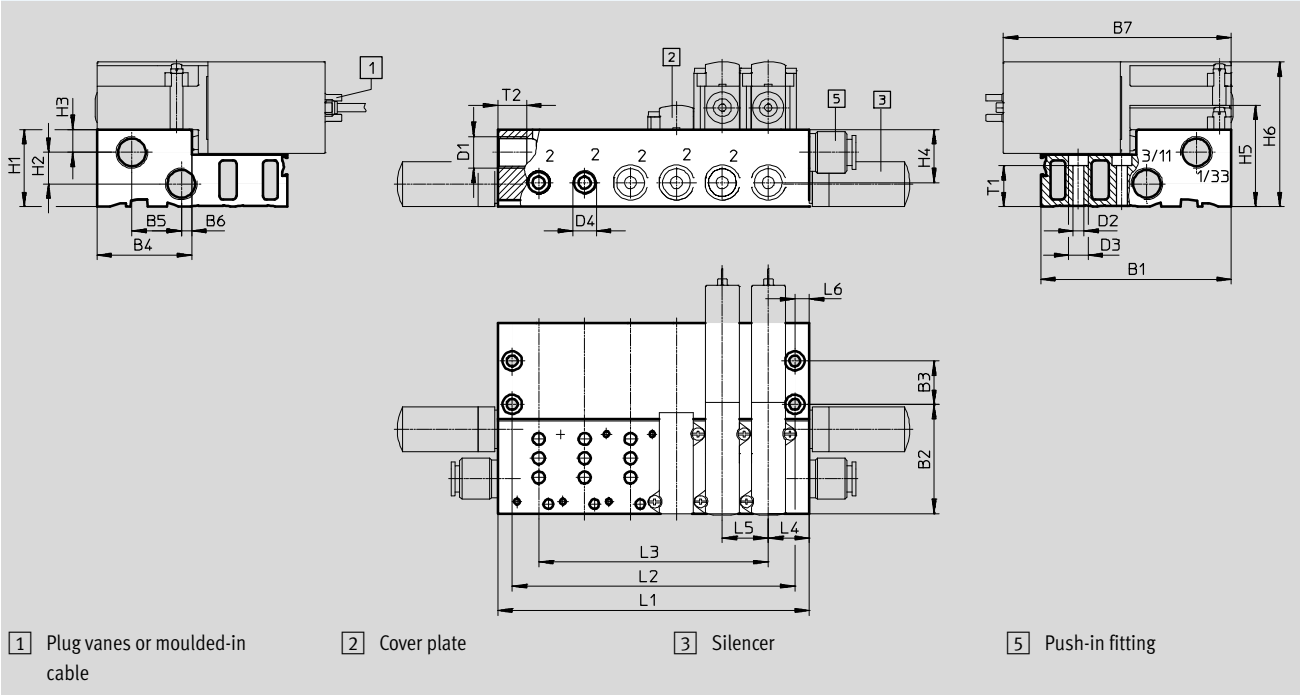

H-rail mounting CPV10/14-VI-BG-NRH-35

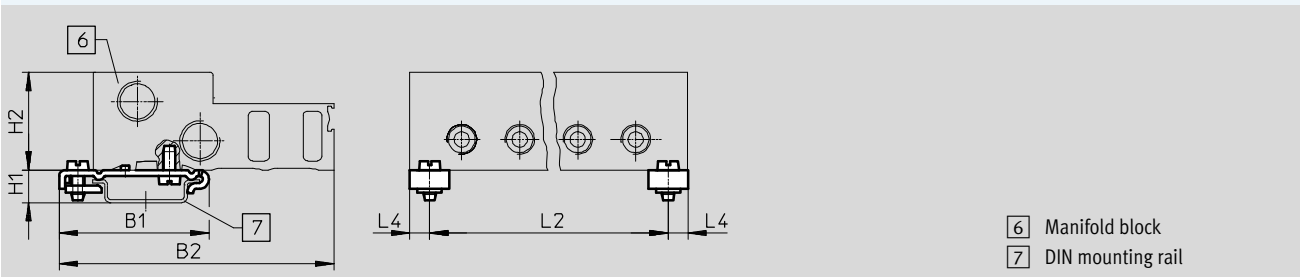

Type	B1	B2	B3	B4	B5	B6	B7	D1	D2	D3	D4	H1	H2	H3	H4	H5	H6
MHA3-PR...-1/8	79	45.3	18	39.3	20.5	4.3	94.3	G¼	4.5	8	G⅛	32	13	9.5	22	42	60
CPV10/14-VI-BG-...	49.1	90	-	-	-	-	-	-	-	-	-	10.7	32	-	-	-	-







Type	L4	L5	L6	T1	T2
MHA3-PR...-1/8	17	19	6	17.1	12
CPV10/14-VI-BG-...	6.5	-	-	-	-

Type		Number of valve positions				
		2	4	6	8	10
MHA3-PR...-1/8	L1	53	91	129	167	205
	L2	41	79	117	155	193
	L3	19	57	95	133	171
CPV10/14-VI-BG-...	L2	41	79	117	155	193

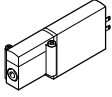
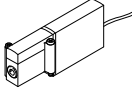
Solenoid valves MHA3, fast-switching valves

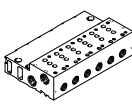
FESTO

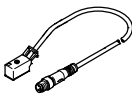



Technical data – Sub-base valve

Ordering data					Part No.	Type
Valves						
	Electrical connection: plug vanes	With fast-switching electronics, switching time 2.3 ms	Normally closed	525135	MHA3-MS1H-3/2G-3	
		Without fast-switching electronics, switching time 8.3 ms	Normally closed	525134	MHA3-M1H-3/2G-3	
	Electrical connection: cable	With fast-switching electronics, switching time 2.3 ms	Normally closed	525137	MHA3-MS1H-3/2G-3-K	
		Without fast-switching electronics, switching time 8.3 ms	Normally closed	525136	MHA3-M1H-3/2G-3-K	
Manifold rail						
	Individual sub-base Pneumatic connection: thread G1/8		1 valve position	525214	MHA3-AS-3-1/8	
	Manifold block Pneumatic connection 1, 11, 3, 33: thread G1/4 Pneumatic connection 2: thread G1/8		2 valve positions	525221	MHA3-PR2-3-1/8	
			4 valve positions	525222	MHA3-PR4-3-1/8	
			6 valve positions	525223	MHA3-PR6-3-1/8	
			8 valve positions	525224	MHA3-PR8-3-1/8	
			10 valve positions	525225	MHA3-PR10-3-1/8	
Cover plate						
	Vacant valve positions must be sealed with a cover plate			525226	MHAP3-BP-3	
Connecting cable						
	2-pin socket, open cable end 2-wire	PUR cable, degree of protection IP65	Signal status display with LED	2.5 m long	193693	KMYZ-3-24-2,5-LED-PUR-B
				5 m long	193695	KMYZ-3-24-5-LED-PUR-B
				10 m long	196066	KMYZ-3-24-10-LED-PUR-B
		PVC cable, degree of protection IP50	Without signal status display	0.5 m long	193690	KMYZ-4-24-0,5-B
	2.5 m long		193691	KMYZ-4-24-2,5-B		
	2-pin socket, push-in connector M8x1 3-pin	PUR cable, degree of protection IP65	Signal status display with LED	0.5 m long	525654	KMYZ-3-24-M8-0,5-LED-PUR
				2.5 m long	525655	KMYZ-3-24-M8-2,5-LED-PUR
Adapter (for valves with plug vanes)						
	2-pin socket	Signal status display with LED	Plug M8, 3-pin	571686	VAVE-C8-1R8	
			Plug M8, 4-pin	573194	VAVE-C8-1R1	

Solenoid valves MHA3, fast-switching valves

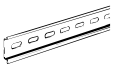
FESTO

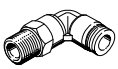
Technical data – Sub-base valve

Ordering data					
				Part No.	Type
H-rail mounting					
	For manifold block			162556	CPV10/14-VI-BG-NRH-35
H-rail					
	To EN 60715	2 m		35430	NRH-35-2000
Silencer					Technical data → Internet: uc
	With threaded connection	G $\frac{1}{8}$	1 piece	161419	UC-1/8
			50 pieces	534219	UC-1/8-50
		G $\frac{1}{4}$	1 piece	165004	UC-1/4
			20 pieces	534220	UC-1/4-20
Push-in fitting					Technical data → Internet: qs
	Male thread G $\frac{1}{8}$ with external hex for tubing O.D.	6 mm	10 pieces	186096	QS-G1/8-6
			100 pieces	132037	QS-G1/8-6-100
		8 mm	10 pieces	186098	QS-G1/8-8
			50 pieces	132038	QS-G1/8-8-50
	Male thread G $\frac{1}{4}$ with external hex for tubing O.D.	8 mm	10 pieces	186099	QS-G1/4-8
			50 pieces	132040	QS-G1/4-8-50
10 mm		10 pieces	186101	QS-G1/4-10	
		50 pieces	132041	QS-G1/4-10-50	
	Male thread G $\frac{1}{8}$ with external hex, push-in L-fitting rotatable through 360° for tubing O.D.	6 mm	10 pieces	186117	QSL-G1/8-6
			100 pieces	132049	QSL-G1/8-6-100
		8 mm	10 pieces	186119	QSL-G1/8-8
			50 pieces	132050	QSL-G1/8-8-50
	Male thread G $\frac{1}{4}$ with external hex, push-in L-fitting rotatable through 360° for tubing O.D.	8 mm	10 pieces	186120	QSL-G1/4-8
			50 pieces	132052	QSL-G1/4-8-50
	10 mm	10 pieces	186122	QSL-G1/4-10	
		50 pieces	132053	QSL-G1/4-10-50	
Blanking plug					
	For thread G $\frac{1}{8}$		10 pieces	3568	B-1/8
	For thread G $\frac{1}{4}$		10 pieces	3569	B-1/4
Inscription label					
	For solenoid valve		80 pieces in frame	197259	MH-BZ-80X

Solenoid valves MH4, fast-switching valves

Type codes

FESTO

MH P 4 - M S 1 H - 3/2 - 0 - QS8

Valve series

MH	Fast-switching valves
----	-----------------------

Design

E	Individual valve
P	Semi in-line valve
A	Sub-base valve

Size

4	Flow rate 400 l/min
---	---------------------

Drive system

M	Solenoid, switching
---	---------------------

Switching time

-	10.5 ms
S	3.5 ms

Operating voltage

1	24 V DC
---	---------

Manual override

H	Non-detenting
---	---------------

Valve function

3/2	3/2-way valve
-----	---------------

Normal position

G	Closed
0	Open

Pneumatic connection

4	Nominal width 4 mm
1/4	Thread G1/4
QS8	Push-in connector for tubing O.D. 8 mm

Electrical connection

-	Plug vanes for plug socket KMEB
K	Moulded-in cable, 2.5 m long

Solenoid valves MHE4, fast-switching valves

Peripherals overview – Individual valve

Connection with plug vanes – Connection with moulded-in cable

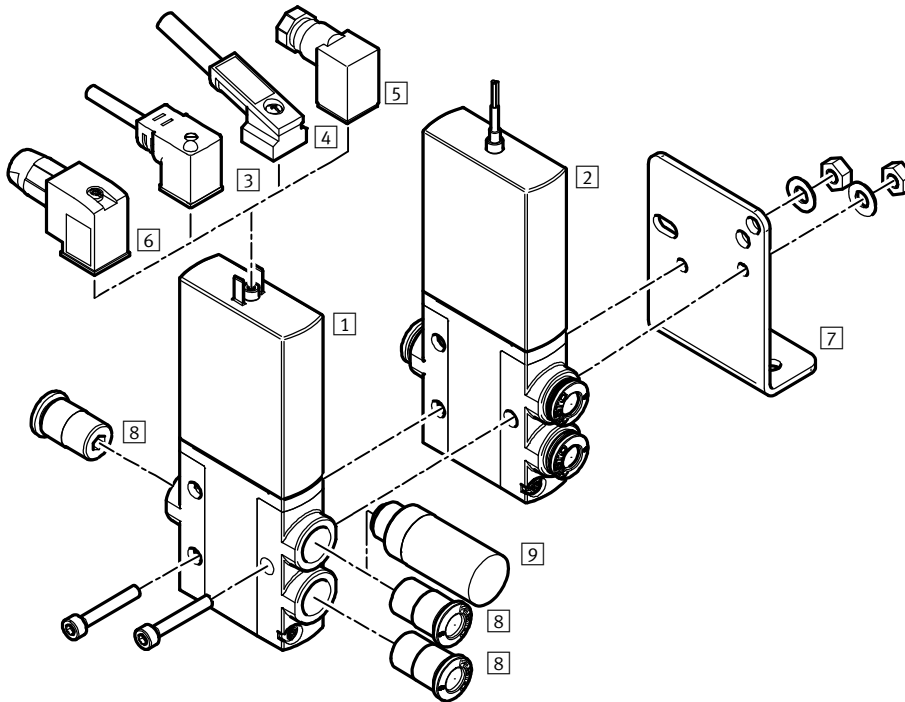

Designation	Brief description	→ Page/Internet
1 Individual valve MHE4	With plug vanes	81
2 Individual valve MHE4-...-K	With cable	81
3 Plug socket with cable KMEB-1 (IP65)	PVC cable, with or without LED	82
4 Plug socket with cable KMEB-2 (IP65)	With LED, without LED; PUR cable, with or without LED	82
5 Plug socket MSSD-EB (IP65)	With clamping screw	82
6 Plug socket MSSD-EB-S-M14 (IP65)	With insulation displacement connector	82
7 Mounting bracket MHE2-BG-L	For wall mounting	82
8 Push-in fittings QS	For connecting compressed air tubing with standard O.D.	82
9 Silencer UC	For mounting in exhaust ports	82



Solenoid valves MHE4, fast-switching valves

Technical data – Individual valve

FESTO

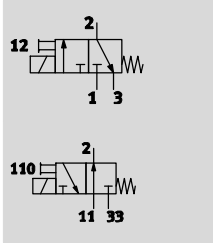
Function



-  - Voltage
24 V DC
-  - Pressure
-0.9 ... +8 bar
-  - Temperature range
-5 ... +60 °C



General technical data		
Valve function		3/2 way, single solenoid ¹⁾
Design		Pressure-relieved poppet valve
Sealing principle		Soft
Reset method		Mechanical spring
Actuation type		Electric
Type of control		Direct
Direction of flow		Reversible with restrictions ²⁾
Exhaust air function		With flow control
Manual override		Non-detenting
Mounting position		Any
Width	[mm]	18
Grid dimension	[mm]	24
Nominal width	[mm]	4
Standard nominal flow rate	[l/min]	400
Type of mounting		Via through-holes
Pneumatic connection		Connecting thread G ¹ / ₄
		Push-in connector for tubing O.D. 8 mm
Product weight	[g]	270

- 1) Can be used as a 2/2-way valve by sealing port 3 or 33
- 2) Slight leakage can occur in the pressure range -0.8 bar to +0.5 bar.

Operating and environmental conditions	With fast-switching electronics	Without fast-switching electronics
	Operating medium	Compressed air to ISO 8573-1:2010 [7:4:4]
Note on operating/pilot medium	Lubricated operation possible (in which case lubricated operation will always be required)	
Operating pressure	[bar]	-0.9 ... +8
Operating pressure, reversible	[bar]	-0.9
Ambient temperature	[°C]	-5 ... +60
Temperature of medium	[°C]	-5 ... +60
Corrosion resistance class CRC ¹⁾		2
CE marking (see declaration of conformity)	To EU EMC Directive ²⁾	-
Certification	c UL us Recognized (OL)	c UL us Recognized (OL)
	C-Tick	-

- 1) Corrosion resistance class 2 according to Festo standard 940 070
Components subject to moderate corrosion stress. Externally visible parts with primarily decorative surface requirements which are in direct contact with a normal industrial environment or media such as coolants or lubricating agents.
- 2) For information about the applicability of the component see the manufacturer's EC declaration of conformity at: www.festo.com/sp → User documentation.
If the component is subject to restrictions on usage in residential, office or commercial environments or small businesses, further measures to reduce the emitted interference may be necessary.

Solenoid valves MHE4, fast-switching valves

Technical data – Individual valve

Electrical data		With fast-switching electronics	Without fast-switching electronics
Electrical connection		2-pin plug or moulded-in cable	
Operating voltage	[V DC]	24 ±10%	
Power consumption	[W]	8.5 (high-current phase)	5.6
	[W]	2.125 (low-current phase)	–
Protection against incorrect polarity		Bipolar	–
Additional functions		Spark arresting	–
		Holding current reduction	–
		Protective circuit	–
Degree of protection to EN 60529	With moulded-in cable	IP65	IP65
	With plug socket with cable KMEB	IP65	IP65

Response times and switching frequencies			With fast-switching electronics	Without fast-switching electronics
Switching time	On	[ms]	3.5 +10% ... -30%	10.5
	Off	[ms]	3.5 +10% ... -40%	5
Switching time variation at 1 Hz and above		[ms]	0.3	–
Maximum switching frequency		[Hz]	210	120

Current curve for valves with fast-switching electronics (MHE4-MS1H)

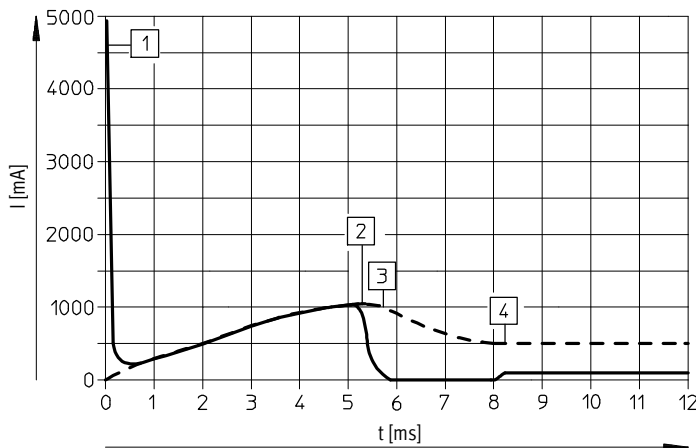

--- Internal current in the coil
 — External current in the supply line

- 1 Capacitor charging
- 2 Controlled coil current 1 A
- 3 Reduction to holding current
- 4 Controlled holding current 0.5 A

Materials

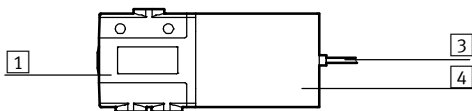

1	Housing	Die-cast zinc, coated
3	Cable sheath	PUR
4	Coil housing	PA
–	Seals	NBR, HNBR
–	Screws	Galvanised steel
Note on materials		Free of copper and PTFE
		RoHS-compliant ¹⁾

1) Not RoHS-compliant: MHE4-M1H-3/20-1/4-K

Solenoid valves MHE4, fast-switching valves

Technical data – Individual valve



Dimensions

Download CAD data → www.festo.com

Valve with plug vanes or moulded-in cable

MHE4-...-1/4-...

MHE4-...-QS8-...

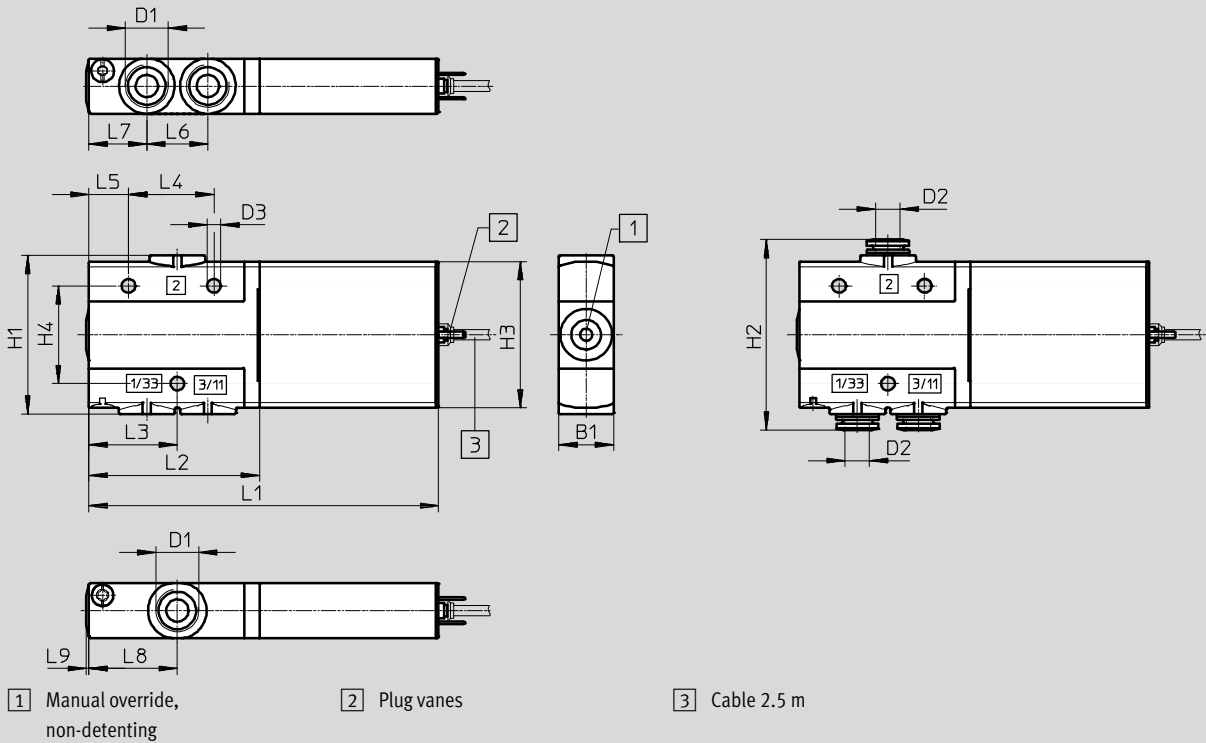

Mounting bracket MHE2-BG-L

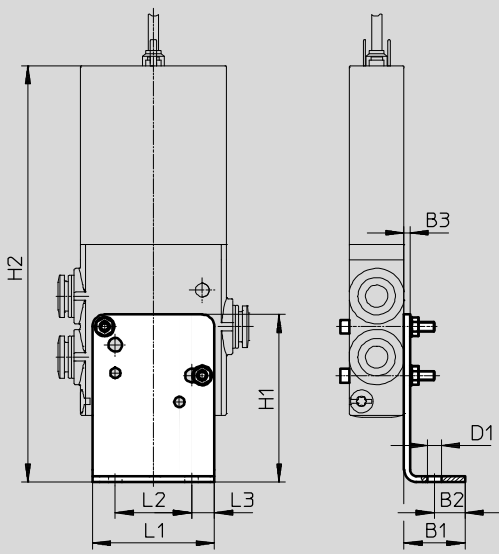

Type	B1	B2	B3	D1	D2 Ø	D3 Ø	H1	H2	H3	H4	L1	L2	L3	L4	L5	L6	L7	L8	L9
MHE4-...-1/4-...	18	-	-	G $\frac{1}{4}$	-	4.5	56	-	48	32	114.6	56	29	28	13	20	19	29	0.8
MHE4-...-QS8-...	18	-	-	-	8	4.5	52	62.4	48	32	114.6	56	29	28	13	20	19	29	0.8
MHE2-BG-L	20	10	2	4.5	-	-	55	134	-	-	40	25	7.5	-	-	-	-	-	-

Solenoid valves MHE4, fast-switching valves

Technical data – Individual valve

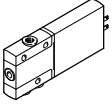
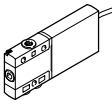









Ordering data						
					Part No.	Type
Valves						
	Electrical connection: plug vanes	With fast-switching electronics, switching time 3.5 ms	Pneumatic connection: thread G $\frac{1}{4}$	Normally open	525207	MHE4-MS1H-3/20-1/4
				Normally closed	525187	MHE4-MS1H-3/2G-1/4
			Pneumatic connection: push-in connector for tubing O.D. 8 mm	Normally open	525211	MHE4-MS1H-3/20-QS8
				Normally closed	525191	MHE4-MS1H-3/2G-QS8
		Without fast-switching electronics, switching time 10.5 ms	Pneumatic connection: thread G $\frac{1}{4}$	Normally open	525206	MHE4-M1H-3/20-1/4
				Normally closed	525186	MHE4-M1H-3/2G-1/4
			Pneumatic connection: push-in connector for tubing O.D. 8 mm	Normally open	525210	MHE4-M1H-3/20-QS8
				Normally closed	525190	MHE4-M1H-3/2G-QS8
	Electrical connection: cable	With fast-switching electronics, switching time 3.5 ms	Pneumatic connection: thread G $\frac{1}{4}$	Normally closed	525189	MHE4-MS1H-3/2G-1/4-K
				Pneumatic connection: push-in connector for tubing O.D. 8 mm	Normally open	525213
			Normally closed		525193	MHE4-MS1H-3/2G-QS8-K
			Without fast-switching electronics, switching time 10.5 ms	Pneumatic connection: thread G $\frac{1}{4}$	Normally open	525208
		Normally closed			525188	MHE4-M1H-3/2G-1/4-K

1) Not RoHS-compliant

Solenoid valves MHE4, fast-switching valves

Technical data – Individual valve

FESTO

Ordering data					Part No.	Type
Plug socket with cable (for valves with plug vanes)						
	3-pin socket, open cable end 3-wire Signal status display with LED	PVC cable, degree of protection IP65	2.5 m long	151688	KMEB-1-24-2,5-LED	
			5 m long	151689	KMEB-1-24-5-LED	
			10 m long	193457	KMEB-1-24-10-LED	
	4-pin socket, open cable end 3-wire Signal status display with LED	PUR cable, degree of protection IP65	2.5 m long	174844	KMEB-2-24-2,5-LED	
			5 m long	174845	KMEB-2-24-5-LED	
	5-pin socket, plug M12 5-pin Signal status display with LED	Cable sheath TPE-U (PU), degree of protection IP65	0.5 m long	177677	KMEB-2-24-M12-0,5-LED	
Plug socket (for valves with plug vanes)						
	Angled socket, without signal status display	Screw terminal Degree of protection IP65	3-pin	151687	MSSD-EB	
		Insulation displacement connection Degree of protection IP67	4-pin	192745	MSSD-EB-S-M14	
Illuminating seal						
	For mounting between plug socket (without signal status display) and valve			151717	MEB-LD-12-24DC	
Wall mounting						
	Mounting bracket			196165	MHE2-BG-L	
Silencer Technical data → Internet: uc						
	Push-in sleeve	Threaded plug PE	8 mm	1 piece	175611	UC-QS-8H
	Threaded connection, polymer design	Threaded plug PE	G $\frac{1}{4}$	1 piece	165004	UC-1/4
				20 pieces	534220	UC-1/4-20
Push-in fitting Technical data → Internet: qs						
	Male thread with external hex	G $\frac{1}{4}$	8 mm	10 pieces	186099	QS-G1/4-8
				50 pieces	132040	QS-G1/4-8-50
			10 mm	10 pieces	186101	QS-G1/4-10
				50 pieces	132041	QS-G1/4-10-50
	Push-in L-fitting, rotatable through 360°, male thread with external hex	G $\frac{1}{4}$	8 mm	10 pieces	186120	QSL-G1/4-8
				50 pieces	132052	QSL-G1/4-8-50
			10 mm	10 pieces	186122	QSL-G1/4-10
				50 pieces	132053	QSL-G1/4-10-50
Blanking plug						
	For thread G $\frac{1}{4}$			10 pieces	3569	B-1/4
Inscription label						
	For solenoid valve			80 pieces	197259	MH-BZ-80X

Solenoid valves MHP4, fast-switching valves

Peripherals overview – Semi in-line valve

Connection via plug vanes

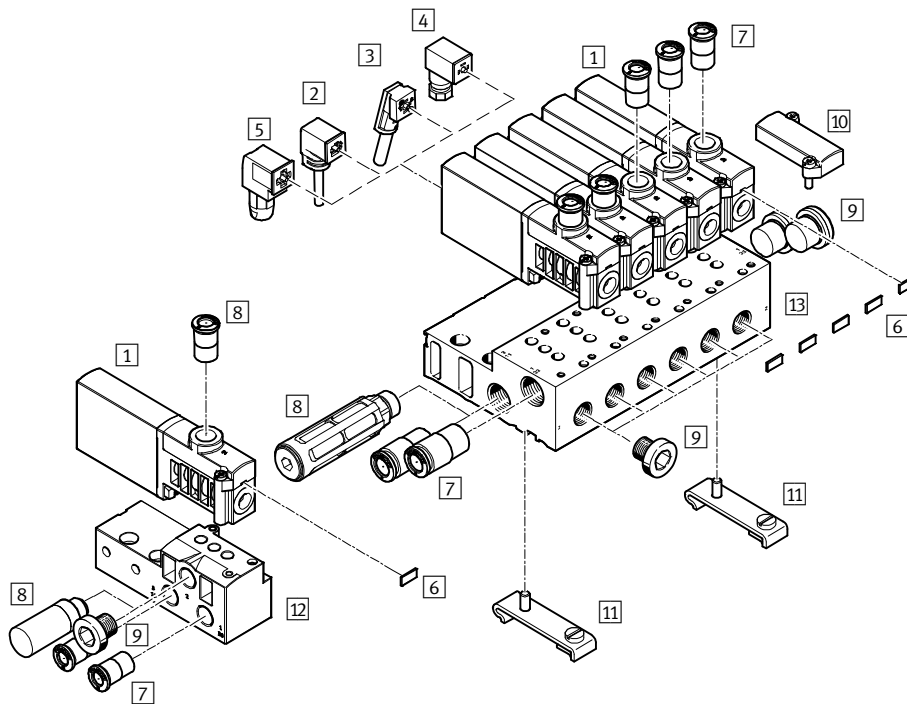

Designation	Brief description	→ Page/Internet
1 Semi in-line valve MHP4	With plug vanes	89
2 Plug socket MSSD-EB (IP65)	With clamping screw	90
3 Plug socket MSSD-EB-S-M14 (IP65)	With insulation displacement connector	90
4 Plug socket with cable KMEB-1 (IP65)	PVC cable, with or without LED	90
5 Plug socket with cable KMEB-2 (IP65)	PUR cable, with or without LED	90
6 Inscription label MH-BZ-80X	For identifying the valves	91
7 Push-in fittings QS	For connecting compressed air tubing with standard O.D.	91
8 Silencer UC	For mounting in exhaust ports	91
9 Blanking plug B	For sealing unused ports	91
10 Cover plate MHAP4-BP-3	For sealing vacant positions	89
11 H-rail mounting CPV10/14-VI-BG-NRH-35	For mounting the manifold block on H-rails according to EN 60715	90
12 Individual sub-base MHA4-AS-3-1/4	For semi in-line valves; the individual sub-base is also used for sub-base valves and must be sealed with a blanking plug here	89
13 Manifold block MHA4-PR...-1/4	For semi in-line valves	89

Solenoid valves MHP4, fast-switching valves

Technical data – Semi in-line valve

FESTO

Function

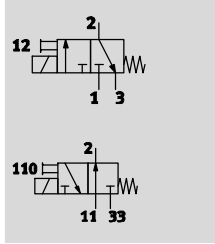

-  - Voltage
24 V DC

-  - Pressure
-0.9 ... +8 bar

-  - Temperature range
-5 ... +40 °C



General technical data		
Valve function		3/2 way, single solenoid ¹⁾
Design		Pressure-relieved poppet valve
Sealing principle		Soft
Reset method		Mechanical spring
Actuation type		Electric
Type of control		Direct
Direction of flow		Reversible with restrictions ²⁾
Exhaust air function		With flow control
Manual override		Non-detenting
Mounting position		Any
Width	[mm]	18
Grid dimension	[mm]	24
Nominal width	[mm]	4
Standard nominal flow rate	[l/min]	400
Type of mounting		On PR rail
Pneumatic connection	2 1, 11, 3, 33	Connecting thread G $\frac{1}{4}$, push-in connector for tubing O.D. 8 mm Sub-base
Product weight	[g]	270

1) Can be used as a 2/2-way valve by sealing port 3 or 33

2) Slight leakage can occur in the pressure range -0.8 bar to +0.5 bar.

Operating and environmental conditions	With fast-switching electronics	Without fast-switching electronics
	Operating medium	Compressed air to ISO 8573-1:2010 [7:4:4]
Note on operating/pilot medium	Lubricated operation possible (in which case lubricated operation will always be required)	
Operating pressure	[bar]	-0.9 ... +8
Operating pressure, reversible	[bar]	-0.9
Ambient temperature	[°C]	-5 ... +40
Temperature of medium	[°C]	-5 ... +40
Corrosion resistance class CRC ¹⁾		2
CE marking (see declaration of conformity)	To EU EMC Directive ²⁾	-
Certification	c UL us Recognized (OL)	c UL us Recognized (OL)
	C-Tick	-

1) Corrosion resistance class 2 according to Festo standard 940 070

Components subject to moderate corrosion stress. Externally visible parts with primarily decorative surface requirements which are in direct contact with a normal industrial environment or media such as coolants or lubricating agents.

2) For information about the applicability of the component see the manufacturer's EC declaration of conformity at: www.festo.com/sp → User documentation.

If the component is subject to restrictions on usage in residential, office or commercial environments or small businesses, further measures to reduce the emitted interference may be necessary.

Solenoid valves MHP4, fast-switching valves

Technical data – Semi in-line valve

Electrical data		With fast-switching electronics	Without fast-switching electronics
Electrical connection		Plug, 2-pin	
Operating voltage	[V DC]	24 ±10%	
Power consumption	[W]	8.5 (high-current phase)	5.6
	[W]	2.125 (low-current phase)	–
Protection against incorrect polarity		Bipolar	–
Additional functions		Spark arresting	–
		Holding current reduction	–
		Protective circuit	–
Degree of protection to EN 60529	With plug socket with cable KMEB	IP65	IP65

Response times and switching frequencies			With fast-switching electronics	Without fast-switching electronics
Switching time	On	[ms]	3.5 +10% ... -30%	10.5
	Off	[ms]	3.5 +10% ... -40%	5
Switching time variation at 1 Hz and above		[ms]	0.3	–
Maximum switching frequency		[Hz]	210	120

Current curve for valves with fast-switching electronics (MHP4-MS1H)

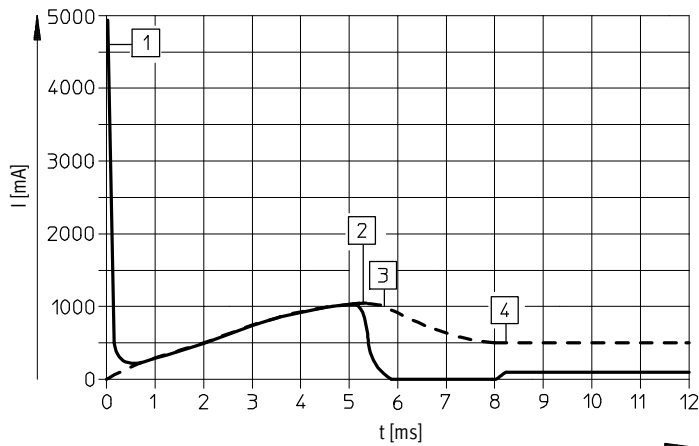

--- Internal current in the coil
 — External current in the supply line

- 1 Capacitor charging
- 2 Controlled coil current 1 A
- 3 Reduction to holding current
- 4 Controlled holding current 0.5 A

Solenoid valves MHP4, fast-switching valves

Technical data – Semi in-line valve



Materials

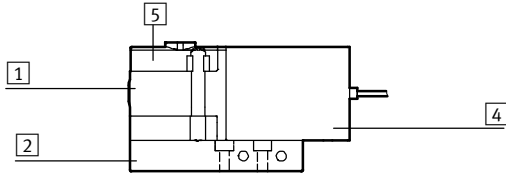

1	Housing	Die-cast zinc, coated
2	Sub-base	Aluminium in the case of the manifold, die-cast zinc in the case of the individual sub-base
4	Coil housing	PA
5	Manifold rail	PA
-	Seals	NBR, HNBR
-	Screws	Galvanised steel
Note on materials		Free of copper and PTFE RoHS-compliant

Dimensions

Download CAD data → www.festo.com

Valve with connecting thread G $\frac{1}{4}$

Valve with push-in connector QS8

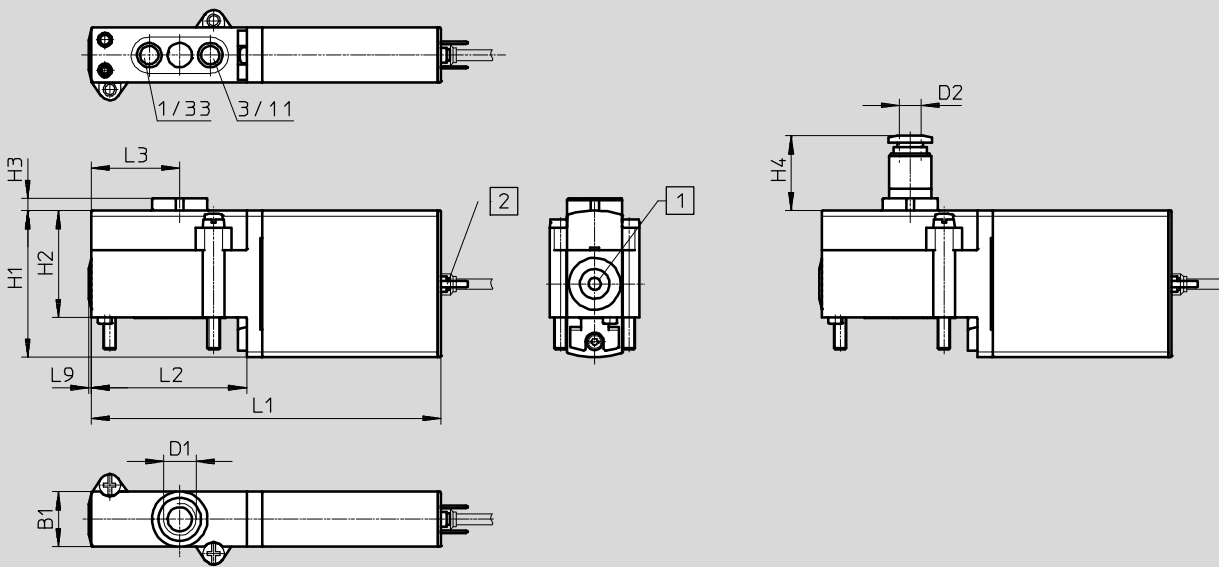

- 1 Manual override, non-detenting
2 Plug vanes

Type	B1	D1	D2 Ø	H1	H2	H3	H4	L1	L2	L3	L9
MHP4-...-3/2...	18	G $\frac{1}{4}$	8	48	35	4	24.5	114.6	51	29	0.8

Solenoid valves MHP4, fast-switching valves

Technical data – Semi in-line valve

Dimensions

Download CAD data → www.festo.com

Hole pattern on sub-bases

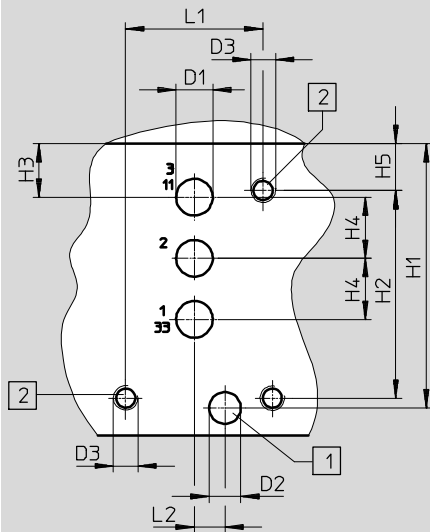

- - Note

With semi in-line valves, port 2 is not used.
If used as a 2/2-way valve, normally closed, ports 3/11 are not used.
If used as a 2/2-way valve, normally open, ports 1/33 are not used.

- 1 Drill hole for coding pin, 2.5 mm deep
- 2 Mounting thread, 13 mm deep

Individual sub-base, MHA4-AS-3-1/4

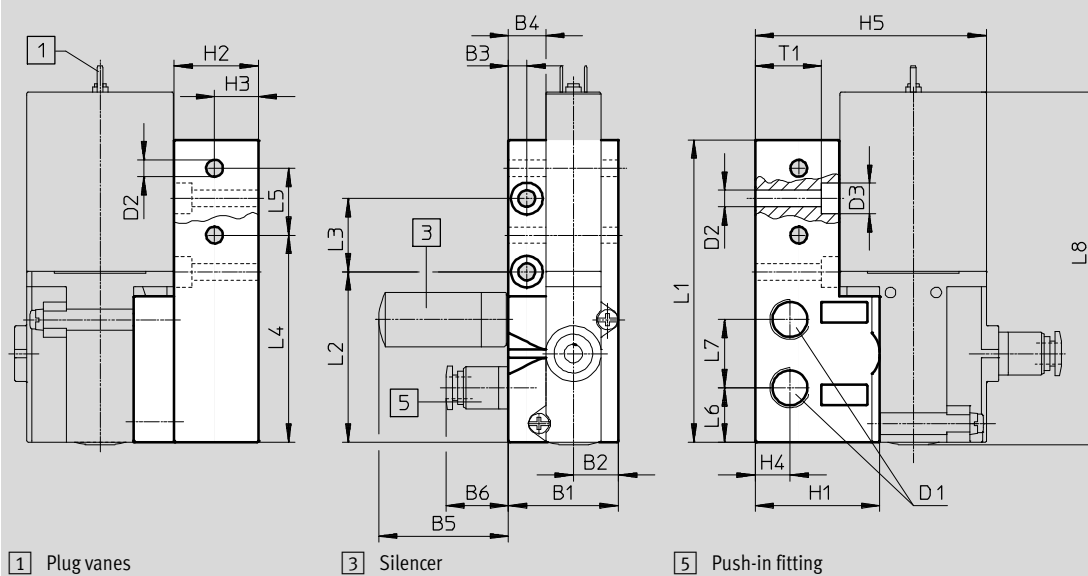

1 Plug vanes

3 Silencer

5 Push-in fitting

Type	B1	B2	B3	B4	B5	B6	D1	D2	D3	H1	H2	H3	H4	H5
Hole pattern	-	-	-	-	-	-	6	5.2	M4	43.3	34	8.8	10	7.7
MHA4-AS-3-1/4	36	14.8	6	12.3	42.5	20.5	G $\frac{1}{4}$	5.5	10	31	27.5	14.3	11.4	75.8

Type	L1	L2	L3	L4	L5	L6	L7	L8	T1
Hole pattern	22.5	5	-	-	-	-	-	-	-
MHA4-AS-3-1/4	99	55.8	24	67.8	21.9	17.8	22.4	115.4	21.8

Solenoid valves MHP4, fast-switching valves

Technical data – Semi in-line valve



Dimensions

Download CAD data → www.festo.com

Manifold assembly, MHA4-PR...-1/4

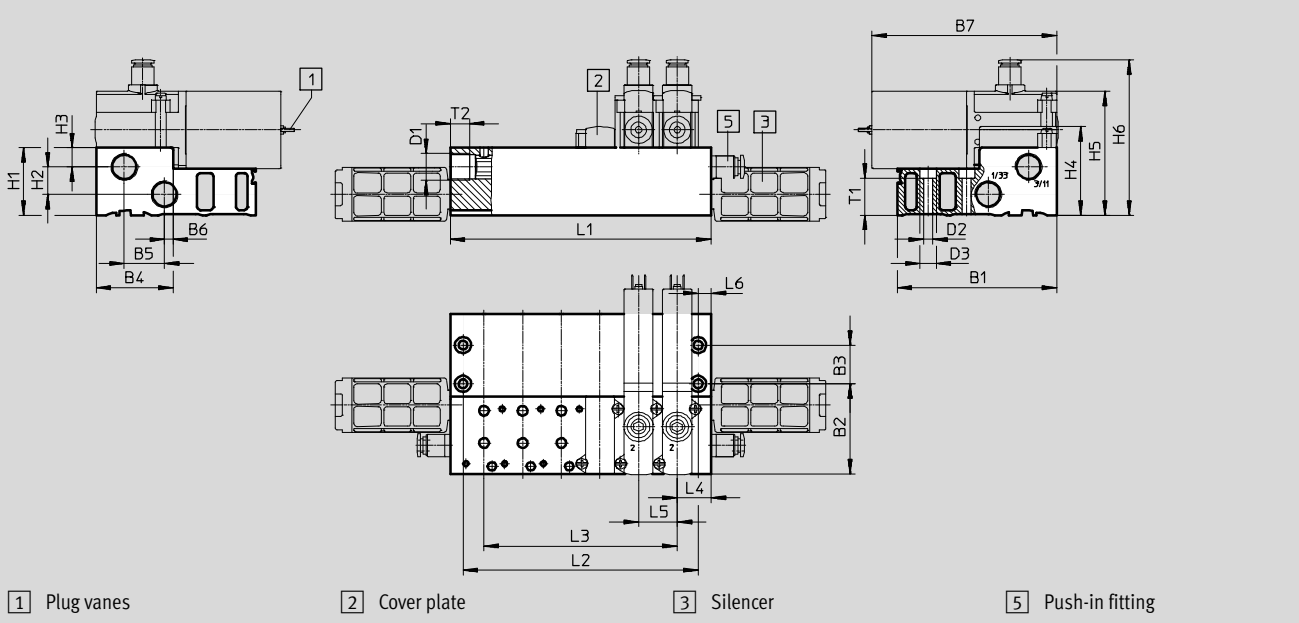

H-rail mounting CPV10/14-VI-BG-NRH-35

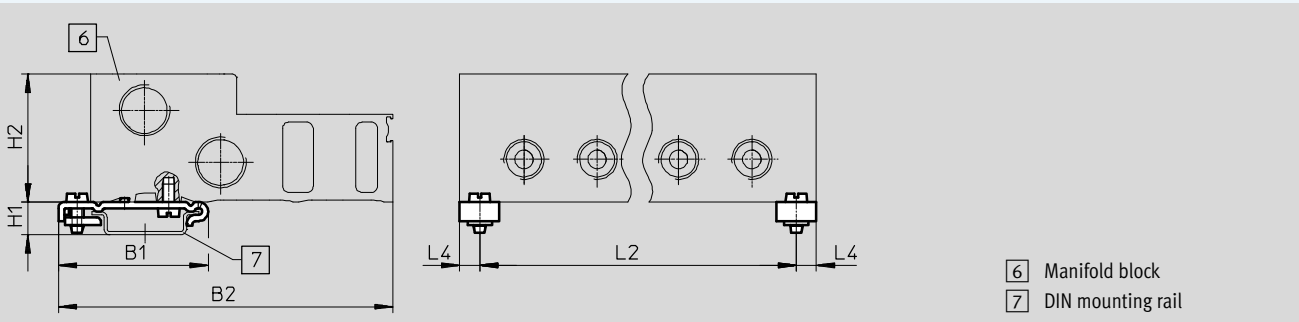





Type	B1	B2	B3	B4	B5	B6	B7	D1	D2	D3	H1	H2	H3	H4	H5	H6	L4	L5	L6	T1	T2
MHA4-PR...-1/4	99	55.8	24	47.8	25	5.3	114.6	G3/8	5.5	10	42	17	12	55	77	96.5	21	24	8	23	12
CPV10/14-VI-BG...	49.1	110	-	-	-	-	-	-	-	-	10.7	42	-	-	-	-	6.5	-	-	-	-

Type		Number of valve positions				
		2	4	6	8	10
MHA4-PR...-1/4	L1	66	114	162	210	258
	L2	50	98	146	194	242
	L3	24	72	120	168	216
CPV10/14-VI-BG...	L2	53	101	149	197	245

- - Note
 Valve types 3.2G and 3/20 must not be mixed on one manifold block.

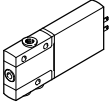
Solenoid valves MHP4, fast-switching valves

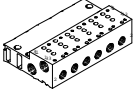
Technical data – Semi in-line valve







Ordering data					Part No.	Type
Valves						
	Electrical connection: plug vanes	With fast-switching electronics, switching time 3.5 ms	Pneumatic connection: thread G $\frac{1}{4}$	Normally open	525199	MHP4-MS1H-3/20-1/4
				Normally closed	525179	MHP4-MS1H-3/2G-1/4
			Pneumatic connection: push-in connector for tubing O.D. 8 mm	Normally closed	525183	MHP4-MS1H-3/2G-QS8
		Without fast-switching electronics, switching time 10.5 ms	Pneumatic connection: thread G $\frac{1}{4}$	Normally open	525198	MHP4-M1H-3/20-1/4
				Normally closed	525178	MHP4-M1H-3/2G-1/4
Manifold rail						
	Individual sub-base ¹⁾ Pneumatic connection: thread G $\frac{1}{4}$			1 valve position	525227	MHA4-AS-3-1/4
	Manifold block ¹⁾ Pneumatic connection 1, 11, 3, 33: thread G $\frac{3}{8}$ Pneumatic connection 2: thread G $\frac{1}{4}$			2 valve positions	525234	MHA4-PR2-3-1/4
				4 valve positions	525235	MHA4-PR4-3-1/4
				6 valve positions	525236	MHA4-PR6-3-1/4
				8 valve positions	525237	MHA4-PR8-3-1/4
				10 valve positions	525238	MHA4-PR10-3-1/4
Cover plate						
	Vacant valve positions must be sealed with a cover plate				525239	MHAP4-BP-3

1) Seal port 2 with a blanking plug. These ports have no function when using semi in-line valves.

 Note
Valve types 3/2G and 3/2O must not be mixed on one manifold block.





Solenoid valves MHP4, fast-switching valves

Technical data – Semi in-line valve

Ordering data				Part No.	Type
Plug socket with cable (for valves with plug vanes)					
	3-pin socket, open cable end 3-wire Signal status display with LED	PVC cable, degree of protection IP65	Length: 2.5 m	151688	KMEB-1-24-2,5-LED
			Length: 5 m	151689	KMEB-1-24-5-LED
			Length: 10 m	193457	KMEB-1-24-10-LED
	4-pin socket, open cable end 3-wire Signal status display with LED	PUR cable, degree of protection IP65	Length: 2.5 m	174844	KMEB-2-24-2,5-LED
			Length: 5 m	174845	KMEB-2-24-5-LED
	5-pin socket, plug M12 5-pin Signal status display with LED	Cable sheath TPE-U (PU), degree of protection IP65	Length: 0.5 m	177677	KMEB-2-24-M12-0,5-LED
Plug socket (for valves with plug vanes)					
	Angled socket, without signal status display	Screw terminal Degree of protection IP65	3-pin	151687	MSSD-EB
		Insulation displacement connection Degree of protection IP67	4-pin	192745	MSSD-EB-S-M14
Illuminating seal					
	For mounting between plug socket (without signal status display) and valve			151717	MEB-LD-12-24DC
H-rail mounting					
	For manifold block			162556	CPV10/14-VI-BG-NRH-35
H-rail					
	To EN 60715		2 m	35430	NRH-35-2000

Solenoid valves MHP4, fast-switching valves

Technical data – Semi in-line valve

Ordering data						Part No.	Type
Silencer						Technical data → Internet: uc	
	Push-in sleeve	Threaded plug PE	8 mm	1 piece	175611	UC-QS-8H	
	Threaded connection, polymer design	Threaded plug PE	G $\frac{1}{4}$	1 piece	165004	UC-1/4	
				20 pieces	534220	UC-1/4-20	
		Housing Polyacetal	G $\frac{3}{8}$	1 piece	2309	U-3/8	
				20 piece	534224	U-3/8-20	
Push-in fitting						Technical data → Internet: qs	
	Male thread with external hex	G $\frac{1}{4}$	8 mm	10 pieces	186099	QS-G1/4-8	
				50 pieces	132040	QS-G1/4-8-50	
			10 mm	10 pieces	186101	QS-G1/4-10	
				50 pieces	132041	QS-G1/4-10-50	
	Male thread with external hex	G $\frac{3}{8}$	10 mm	10 pieces	186102	QS-G3/8-10	
				50 pieces	132044	QS-G3/8-10-50	
12 mm			10 pieces	186103	QS-G3/8-12		
			20 pieces	132045	QS-G3/8-12-20		
	Push-in L-fitting, rotatable through 360°, male thread with external hex	G $\frac{1}{4}$	8 mm	10 pieces	186120	QSL-G1/4-8	
				50 pieces	132052	QSL-G1/4-8-50	
			10 mm	10 pieces	186122	QSL-G1/4-10	
				50 pieces	132053	QSL-G1/4-10-50	
	Push-in L-fitting, rotatable through 360°, male thread with external hex	G $\frac{3}{8}$	10 mm	10 pieces	186123	QSL-G3/8-10	
				20 pieces	132056	QSL-G3/8-10-20	
12 mm			10 pieces	186124	QSL-G3/8-12		
			20 pieces	132057	QSL-G3/8-12-20		
Blanking plug							
	For thread G $\frac{1}{4}$			10 pieces	3569	B-1/4	
	For thread G $\frac{3}{8}$			10 pieces	3570	B-3/8	
Inscription label							
	For solenoid valve			80 pieces	197259	MH-BZ-80X	

Solenoid valves MHA4, fast-switching valves

Peripherals overview – Sub-base valve

FESTO

Connection with plug vanes – Connection with moulded-in cable

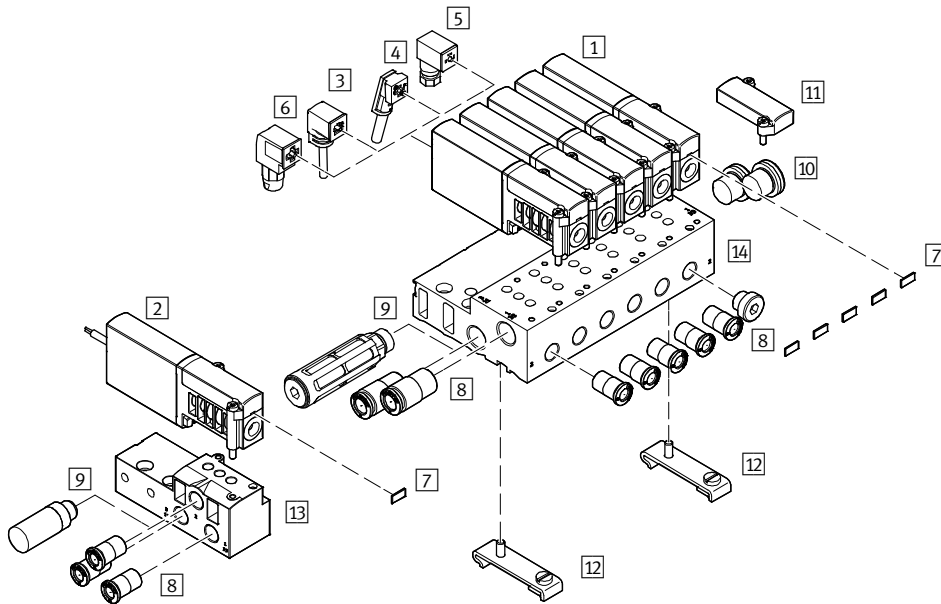

Designation	Brief description	→ Page/Internet
1 Sub-base valves MHA4	With plug vanes	98
2 Sub-base valves MHA4-...-K	With cable	98
3 Plug socket with cable KMEB-1 (IP65)	PVC cable, with or without LED	99
4 Plug socket with cable KMEB-2 (IP65)	PUR cable, with or without LED	99
5 Plug socket MSSD-EB (IP65)	With clamping screw	99
6 Plug socket MSSD-EB-S-M14 (IP65)	With insulation displacement connector	99
7 Inscription label MH-BZ-80X	For identifying the valves	100
8 Push-in fittings QS	For connecting compressed air tubing with standard O.D.	100
9 Silencer UC	For mounting in exhaust ports	100
10 Blanking plug B	For sealing unused ports	100
11 Cover plate MHAP4-BP-3	For sealing vacant positions	98
12 H-rail mounting CPV10/14-VI-BG-NRH-35	For mounting the manifold block on H-rails according to EN 60715	99
13 Individual sub-base MHA4-AS-3-1/4	For sub-base valves	98
14 Manifold block MHA4-PR...-1/4	For sub-base valves	98

Solenoid valves MHA4, fast-switching valves

Technical data – Sub-base valve

Function

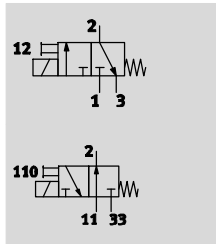

- - Voltage
24 V DC
- - Pressure
-0.9 ... +8 bar
- - Temperature range
-5 ... +40 °C



General technical data		
Valve function		3/2 way, single solenoid ¹⁾
Design		Pressure-relieved poppet valve
Sealing principle		Soft
Reset method		Mechanical spring
Actuation type		Electric
Type of control		Direct
Direction of flow		Reversible with restrictions ²⁾
Exhaust air function		With flow control
Manual override		Non-detenting
Mounting position		Any
Width	[mm]	18
Grid dimension	[mm]	24
Nominal width	[mm]	4
Standard nominal flow rate	[l/min]	400
Type of mounting		On PR rail
Pneumatic connection	1, 11, 2, 3, 33	Sub-base
Product weight	[g]	270

- 1) Can be used as a 2/2-way valve by sealing port 3 or 33
- 2) Slight leakage can occur in the pressure range -0.8 bar to +0.5 bar.

Operating and environmental conditions		
	With fast-switching electronics	Without fast-switching electronics
Operating medium	Compressed air to ISO 8573-1:2010 [7:4:4]	
Note on operating/pilot medium	Lubricated operation possible (in which case lubricated operation will always be required)	
Operating pressure	[bar]	-0.9 ... +8
Operating pressure, reversible	[bar]	-0.9
Ambient temperature	[°C]	-5 ... +40
Temperature of medium	[°C]	-5 ... +40
Corrosion resistance class CRC ¹⁾	2	
CE marking (see declaration of conformity)	To EU EMC Directive ²⁾	-
Certification	c UL us Recognized (OL)	c UL us Recognized (OL)
	C-Tick	-

- 1) Corrosion resistance class 2 according to Festo standard 940 070
Components subject to moderate corrosion stress. Externally visible parts with primarily decorative surface requirements which are in direct contact with a normal industrial environment or media such as coolants or lubricating agents.
- 2) For information about the applicability of the component see the manufacturer's EC declaration of conformity at: www.festo.com/sp → User documentation.
If the component is subject to restrictions on usage in residential, office or commercial environments or small businesses, further measures to reduce the emitted interference may be necessary.

Solenoid valves MHA4, fast-switching valves

Technical data – Sub-base valve

Electrical data		With fast-switching electronics	Without fast-switching electronics
Electrical connection		2-pin plug or moulded-in cable	
Operating voltage	[V DC]	24 ±10%	
Power consumption	[W]	8.5 (high-current phase)	5.6
	[W]	2.125 (low-current phase)	–
Protection against incorrect polarity		Bipolar	–
Additional functions		Spark arresting	–
		Holding current reduction	–
		Protective circuit	–
Degree of protection to EN 60529	With moulded-in cable	IP65	IP65
	With plug socket with cable KMEB	IP65	IP65

Response times and switching frequencies			
		With fast-switching electronics	Without fast-switching electronics
Switching time	On [ms]	3.5 +10% ... -30%	10.5
	Off [ms]	3.5 +10% ... -40%	5
Switching time variation at 1 Hz and above	[ms]	0.3	–
Maximum switching frequency	[Hz]	210	120

Current curve for valves with fast-switching electronics (MHA4-MS1H)

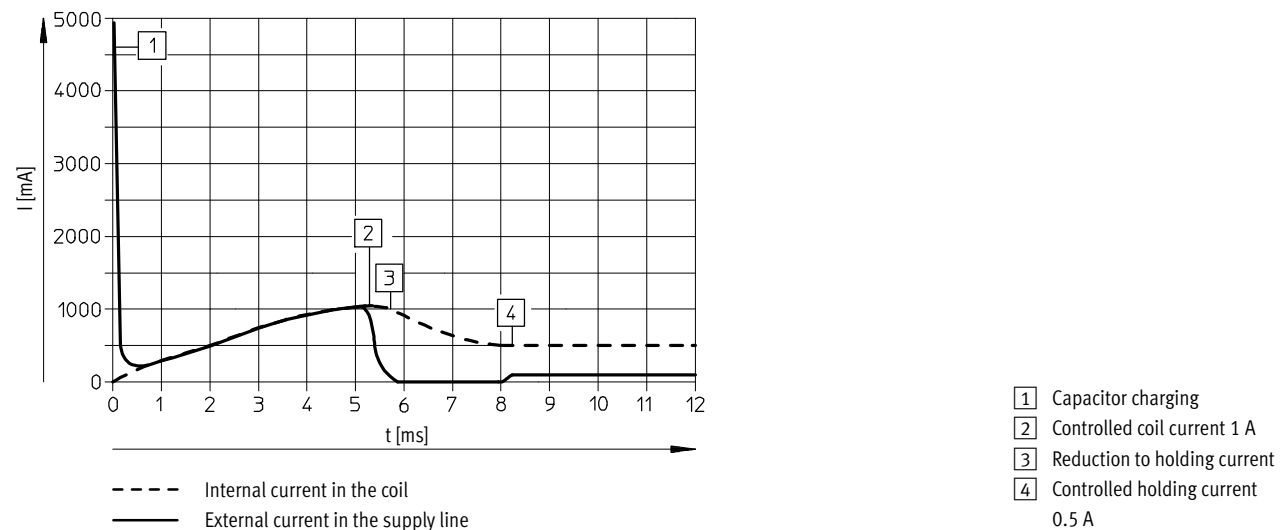

Solenoid valves MHA4, fast-switching valves

Technical data – Sub-base valve

Materials

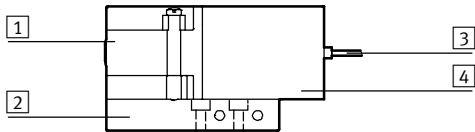

1	Housing	Die-cast zinc, coated
2	Sub-base	Aluminium in the case of the manifold, die-cast zinc in the case of individual sub-base
3	Cable sheath	PUR
4	Coil housing	PA
-	Seals	NBR, HNBR
-	Screws	Galvanised steel
Note on materials		Free of copper and PTFE RoHS-compliant

Dimensions

Download CAD data → www.festo.com

Valve with plug vanes or moulded-in cable, MHA4-...-3/2...

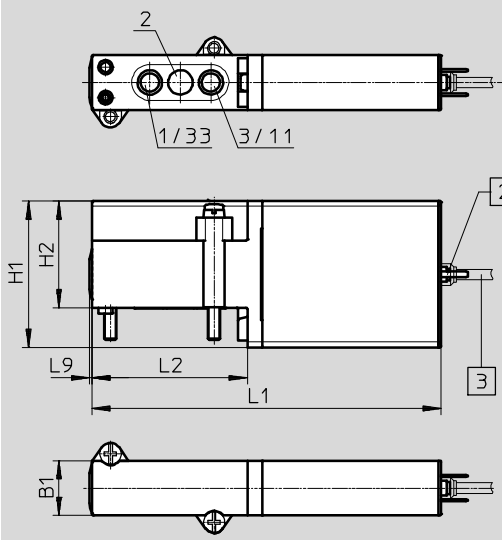

- 1 Manual override, non-detenting
- 2 Plug vanes
- 3 Cable 2.5 m

Type	B1	H1	H2	L1	L2	L9
MHA4-...-3/2...	18	48	35	114.6	51	0.8

Solenoid valves MHA4, fast-switching valves

Technical data – Sub-base valve

Dimensions

Download CAD data → www.festo.com

Hole pattern on sub-bases

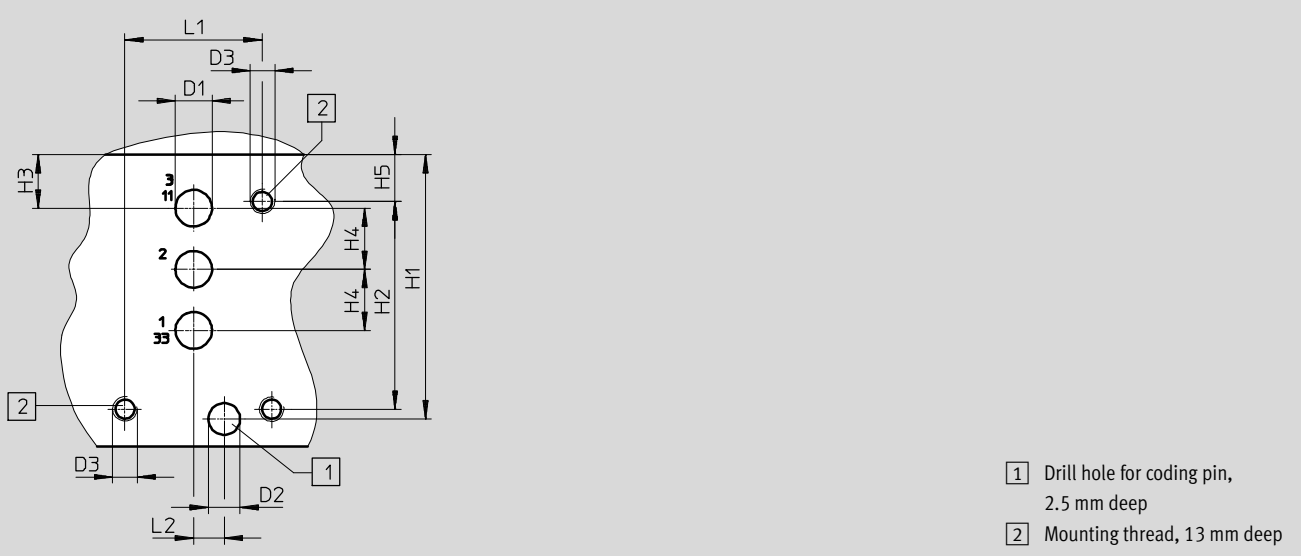

Individual sub-base, MHA4-AS-3-1/4

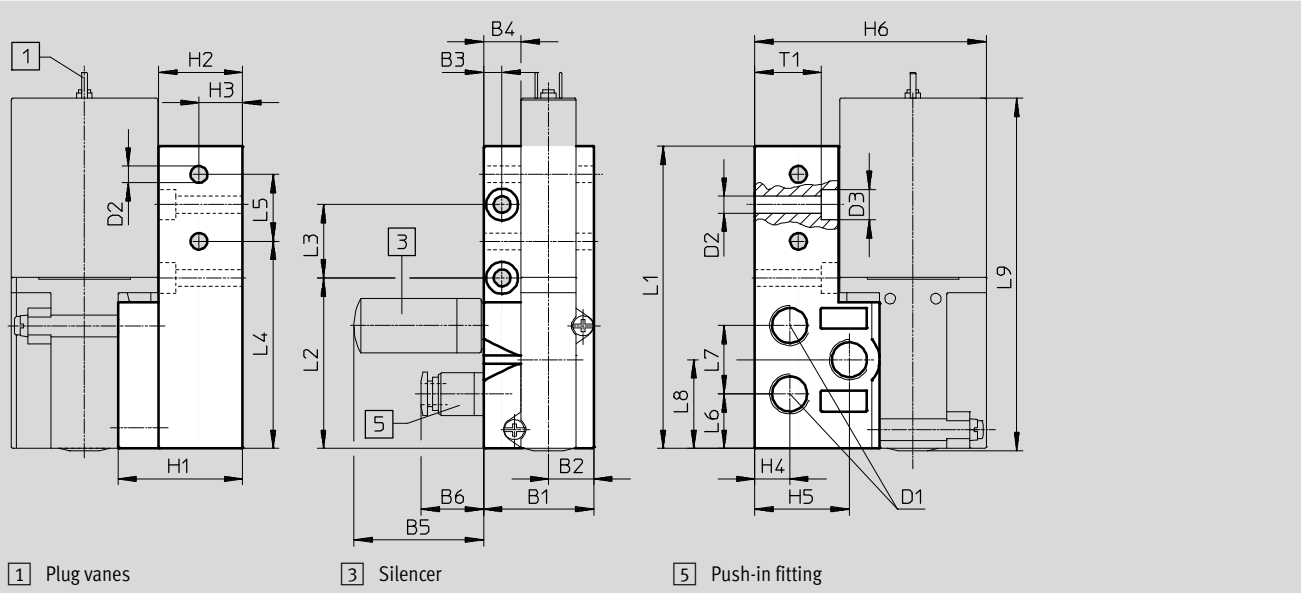

Type	B1	B2	B3	B4	B5	B6	D1	D2 ∅	D3 ∅	H1	H2	H3	H4	H5	H6
Hole pattern	–	–	–	–	–	–	6	5.2	M4	43.3	34	8.8	10	7.7	–
MHA4-AS-3-1/4	36	14.8	6	12.3	42.5	20.5	G $\frac{1}{4}$	5.5	10	40.8	27.5	14.3	11.4	31	75.8

Type	L1	L2	L3	L4	L5	L6	L7	L8	L9	T1
Hole pattern	22.5	5	–	–	–	–	–	–	–	–
MHA4-AS-3-1/4	99	55.8	24	67.8	21.9	17.8	22.4	29	115.4	21.8

Solenoid valves MHA4, fast-switching valves

Technical data – Sub-base valve

Dimensions

Download CAD data → www.festo.com

Manifold assembly, MHA4-PR...-1/4

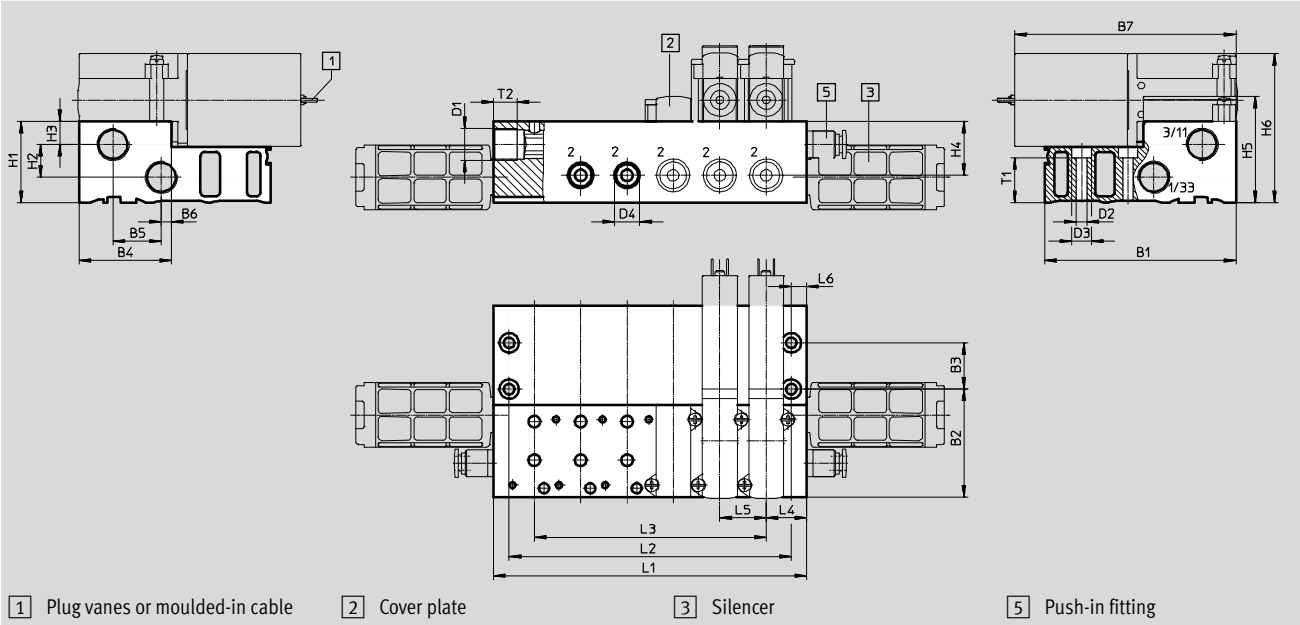

H-rail mounting CPV10/14-VI-BG-NRH-35

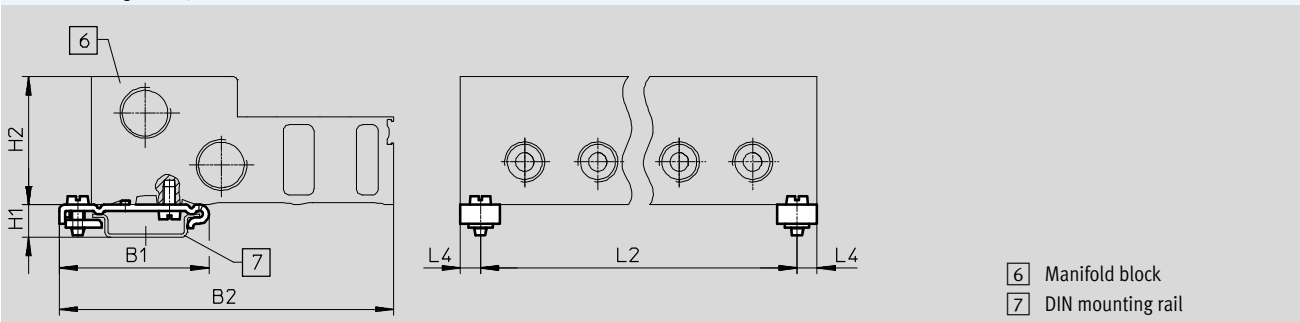





Type	B1	B2	B3	B4	B5	B6	B7	D1	D2	D3	D4	H1	H2	H3	H4	H5	H6
MHA4-PR...-1/4	99	55.8	24	47.8	25	5.3	114.6	G $\frac{3}{8}$	5.5	10	G $\frac{1}{4}$	42	17	12	28	55	77
CPV10/14-VI-BG-...	49.1	110	-	-	-	-	-	-	-	-	-	10.7	42	-	-	-	-

Type	L4	L5	L6	T1	T2
MHA4-PR...-1/4	21	24	8	23	12
CPV10/14-VI-BG-...	6.5	-	-	-	-

Type		Number of valve positions				
		2	4	6	8	10
MHA4-PR...-1/4	L1	66	114	162	210	258
	L2	50	98	146	194	242
	L3	24	72	120	168	216
CPV10/14-VI-BG-...	L2	53	101	149	197	245

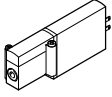
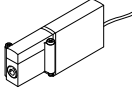
Solenoid valves MHA4, fast-switching valves

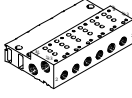
Technical data – Sub-base valve







Ordering data				Part No.	Type
Valves					
	Electrical connection: plug vanes	With fast-switching electronics, switching time 3.5 ms	Normally closed	525175	MHA4-MS1H-3/2G-4
		Without fast-switching electronics, switching time 10.5 ms	Normally closed	525174	MHA4-M1H-3/2G-4
	Electrical connection: cable	With fast-switching electronics, switching time 3.5 ms	Normally closed	525177	MHA4-MS1H-3/2G-4-K
		Without fast-switching electronics, switching time 10.5 ms	Normally open	525196	MHA4-M1H-3/2O-4-K
			Normally closed	525176	MHA4-M1H-3/2G-4-K
Manifold rail					
	Individual sub-base	Pneumatic connection: thread G1/4	1 valve position	525227	MHA4-AS-3-1/4
	Manifold block		2 valve positions	525234	MHA4-PR2-3-1/4
	Pneumatic connection 1, 11, 3, 33: thread G3/8 Pneumatic connection 2: thread G1/4	4 valve positions	525235	MHA4-PR4-3-1/4	
		6 valve positions	525236	MHA4-PR6-3-1/4	
		8 valve positions	525237	MHA4-PR8-3-1/4	
		10 valve positions	525238	MHA4-PR10-3-1/4	
Cover plate					
	Vacant valve positions must be sealed with a cover plate			525239	MHA4-BP-3

-  - Note

Valve types 3/2G and 3/2O must not be mixed on one manifold block.

Solenoid valves MHA4, fast-switching valves





Technical data – Sub-base valve

Ordering data				Part No.	Type
Plug socket with cable (for valves with plug vanes)					
	3-pin socket, open cable end 3-wire Signal status display with LED	PVC cable, degree of protection IP65	2.5 m long	151688	KMEB-1-24-2,5-LED
			5 m long	151689	KMEB-1-24-5-LED
			10 m long	193457	KMEB-1-24-10-LED
	4-pin socket, open cable end 3-wire Signal status display with LED	PUR cable, degree of protection IP65	2.5 m long	174844	KMEB-2-24-2,5-LED
			5 m long	174845	KMEB-2-24-5-LED
	5-pin socket, plug M12 5-pin Signal status display with LED	Cable sheath TPE-U (PU), degree of protection IP65	0.5 m long	177677	KMEB-2-24-M12-0,5-LED
Plug socket (for valves with plug vanes)					
	Angled socket, without signal status display	Screw terminal Degree of protection IP65	3-pin	151687	MSSD-EB
		Insulation displacement connection Degree of protection IP67	4-pin	192745	MSSD-EB-S-M14
Illuminating seal					
	For mounting between plug socket (without signal status display) and valve			151717	MEB-LD-12-24DC
H-rail mounting					
	For manifold block			162556	CPV10/14-VI-BG-NRH-35
H-rail					
	To EN 60715		2 m	35430	NRH-35-2000

Solenoid valves MHA4, fast-switching valves

FESTO

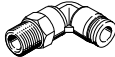
Technical data – Sub-base valve

Ordering data						Part No.	Type
Silencer						Technical data → Internet: uc	
	Push-in sleeve	Threaded plug PE	8 mm	1 piece	175611	UC-QS-8H	
	Threaded connection, polymer design	Threaded plug PE	G $\frac{1}{4}$	1 piece	165004	UC-1/4	
				20 pieces	534220	UC-1/4-20	
		Housing POM	G $\frac{3}{8}$	1 piece	2309	U-3/8	
20 pieces	534224			U-3/8-20			
Push-in fitting						Technical data → Internet: qs	
	Male thread with external hex	G $\frac{1}{4}$	8 mm	10 pieces	186099	QS-G1/4-8	
				50 pieces	132040	QS-G1/4-8-50	
			10 mm	10 pieces	186101	QS-G1/4-10	
				50 pieces	132041	QS-G1/4-10-50	
	Male thread with external hex	G $\frac{3}{8}$	10 mm	10 pieces	186102	QS-G3/8-10	
				50 pieces	132044	QS-G3/8-10-50	
12 mm			10 pieces	186103	QS-G3/8-12		
			20 pieces	132045	QS-G3/8-12-20		
	Push-in L-fitting, rotatable through 360°, male thread with external hex	G $\frac{1}{4}$	8 mm	10 pieces	186120	QSL-G1/4-8	
				50 pieces	132052	QSL-G1/4-8-50	
			10 mm	10 pieces	186122	QSL-G1/4-10	
	50 pieces	132053		QSL-G1/4-10-50			
	Push-in L-fitting, rotatable through 360°, male thread with external hex	G $\frac{3}{8}$	10 mm	10 pieces	186123	QSL-G3/8-10	
				20 pieces	132056	QSL-G3/8-10-20	
12 mm			10 pieces	186124	QSL-G3/8-12		
	20 pieces	132057	QSL-G3/8-12-20				
Blanking plug							
	For thread G $\frac{1}{4}$			10 pieces	3569	B-1/4	
	For thread G $\frac{3}{8}$			10 pieces	3570	B-3/8	
Inscription label							
	For solenoid valve			80 pieces	197259	MH-BZ-80X	