

Radial grippers HGRT, heavy-duty



Radial grippers HGRT, heavy-duty

Key features



At a glance

- Sturdy and precise kinematics for maximum torque resistance and long service life
- The virtually backlash-free plain-bearing guide is realised using ground-in gripper jaws
- Systematic use of high-performance and lightweight materials
- The force generated by the linear motion is translated into the gripper jaw movement via a slotted guide system at the piston rod. This also guarantees synchronous movement of the gripper jaws
- The opening angle of the gripper jaws is freely adjustable up to max. 90° per gripper finger. This reduces the cycle time and prevents possible collisions due to the gripper jaws opening too wide
- Can be used as a double-acting or single-acting gripper
- Compression spring for supplementary or retaining gripping forces
- Suitable for external and internal gripping
- Wide range of options for mounting on drives

Flexible stroke limitation As radial gripper

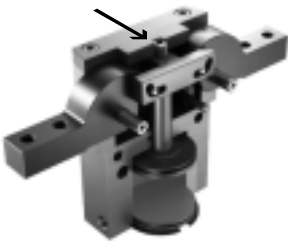

The gripper as delivered features a fixed stop that enables an opening angle of 180°.

As angle gripper with adjustable stroke



The stroke reducing kit HGRT-HR, which can be ordered as an accessory, enables the opening angle to be reduced by means of an adjustment screw. This provides an easy means of converting the radial gripper into an angle gripper.

Additional ports For sealing air

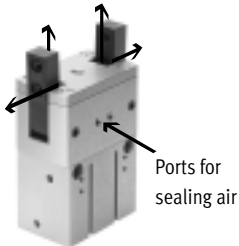

Compressed air flows past the gripper jaw when sealing air (max. 0.5 bar) is connected. This prevents particles, for example, from entering the gripper jaw guide.

For lubrication

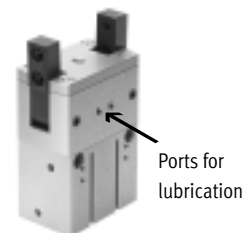

The ports can also be used to re-lubricate the guide.

Position sensing/force control

With position transmitter SMAT-8M, SDAT



Analogue positional feedback possible

- Analogue output
 - 0 ... 10 V
 - 4 ... 20 mA

With proportional pressure regulator VPPM



Infinite adjustment of the gripping force possible

- Setpoint input
 - 0 ... 10 V
 - 4 ... 20 mA

With proximity sensor SMT-8G/-10G



Multiple positions can be sensed:

- Open
- Closed
- Workpiece gripped

Radial grippers HGRT, heavy-duty

Key features

Supply ports
Direct

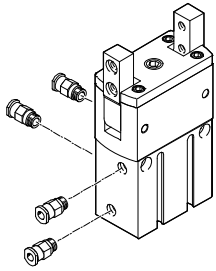

Via adapter plate

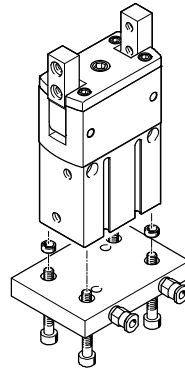

Note

Gripper selection
sizing software
→ www.festo.com

Mounting options

Direct mounting
From the side

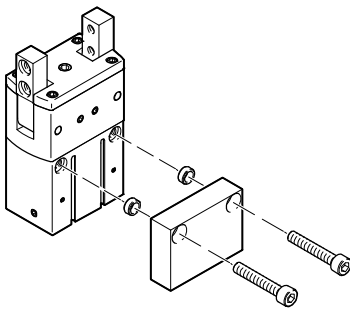

On front face

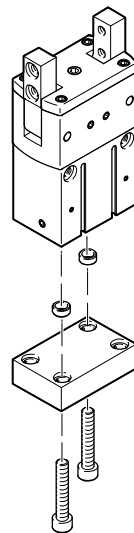

Note

Radial grippers are not designed for the following sample applications:

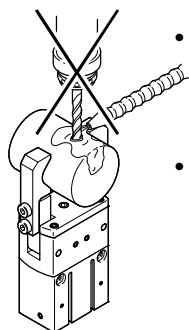

- Machining
- Aggressive media

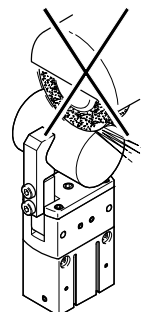

- Grinding dust

- Welding splashes

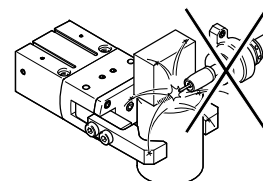

Radial grippers HGRT, heavy-duty

Peripherals overview

FESTO

Peripherals overview

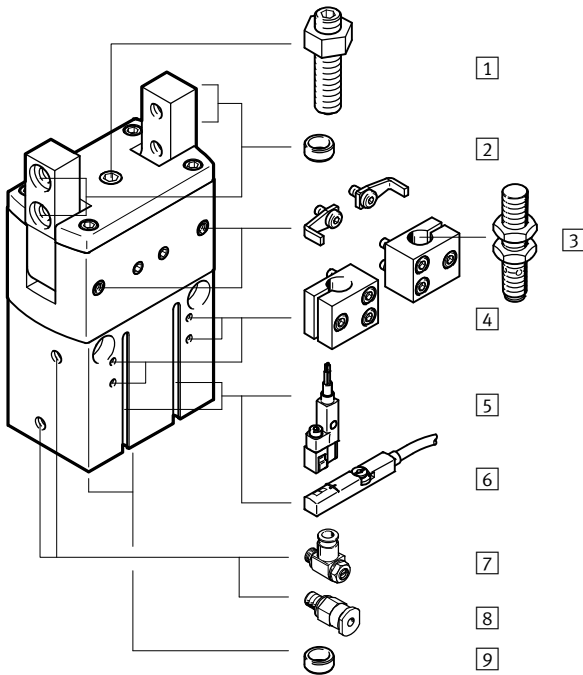

System product for handling and assembly technology

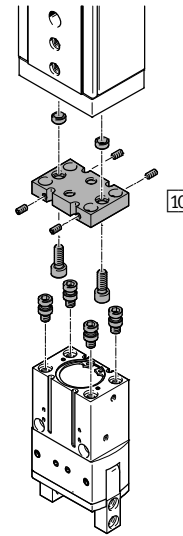

Proportional pressure regulator VPPM

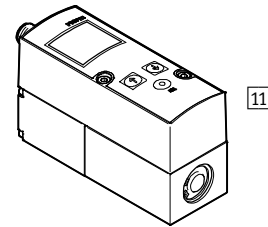

Accessories			
Type	Size	Description	→ Page/Internet
1 Stroke reducing kit HGRT-HR	16 ... 50	For adjusting the opening angle	20
2 Centring sleeve ZBH	16 ... 50	<ul style="list-style-type: none"> For centring when attaching gripper fingers 4 included in the scope of delivery of the gripper 	21
3 Proximity sensor SIEN	16 ... 50	For sensing the piston position	22
4 Sensor bracket DASI	16 ... 50	<ul style="list-style-type: none"> For mounting the proximity sensors SIEN on the gripper The scope of delivery of the sensor bracket includes switch lugs 	20
5 Proximity sensor SMT-8G/-10G	16 ... 50	<ul style="list-style-type: none"> For sensing the piston position The proximity sensor is flush with the housing at the bottom 	21
6 Position transmitter SMAT-8M	40	<ul style="list-style-type: none"> Continuously senses the position of the piston. It has an analogue output with an output signal that is proportional to the piston position. 	21
Position transmitter SDAT	50		
7 One-way flow control valve GRLA	16 ... 50	For regulating speed	grla
8 Push-in fitting QS	16 ... 50	For connecting compressed air tubing with standard O.D.	quick star
9 Centring sleeve ZBH	16 ... 50	For centring when attaching to a drive or plate	21
10 Adapter kit DHAA/HAPG	16 ... 50	Connecting plate between drive and gripper	17
11 Proportional pressure regulator VPPM	16 ... 50	For infinite adjustment of the gripping force	vppm

Radial grippers HGRT, heavy-duty

Type codes

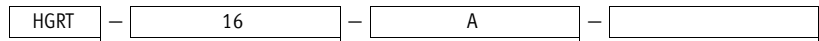

Type

HGRT	Radial gripper
------	----------------

Size

Position sensing

A	Via proximity sensor
---	----------------------

Gripping force retention

G2	Closing
----	---------

Radial grippers HGRT, heavy-duty

Technical data

FESTO

Function
Double-acting
HGRT...

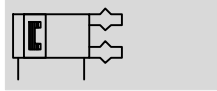

⊘ - Size
12 ... 50 mm

┆ - Opening angle
180°

Function – Variants
Single-acting or with gripping force retention



Wearing parts kits
→ 16



General technical data														
Size	16		20		25		32		40		50			
Design	Force-guided motion sequence													
Mode of operation	Double-acting													
Gripper function	Radial													
Number of gripper jaws	2													
Max. opening angle	[°] 180													
Pneumatic connection	M3		M5		M5		M5		G1/8		G1/8			
Repetition accuracy ¹⁾	[mm]		≤ 0.02											
Max. interchangeability	[mm]		≤ 0.2											
Max. gripper jaw backlash ²⁾	[mm]		≤ 0.1											
Max. gripper jaw angular backlash ³⁾	[°]		≤ 0.1											
Max. permitted working frequency	[Hz]		≤ 3						≤ 2					
Rotational symmetry	[mm]		≤ ∅ 0.2											
Position sensing	Via proximity sensor													
	-										Position transmitter			
Type of mounting	Via female thread and centring sleeve													
Mounting position	Any													
Product weight	- [g]		130		290		540		840		1580		3100	
	G2 [g]		150		320		610		940		1770		3500	

- 1) End-position drift under constant conditions of use with 100 consecutive strokes in the direction of movement of the gripper jaws
- 2) Perpendicular to the direction of motion of the gripper jaws
- 3) Preloaded, backlash-free ball bearing guide

Operating and environmental conditions		
Operating pressure	- [bar]	3 ... 8
	G2 [bar]	4 ... 8
Operating medium	Compressed air in accordance with ISO 8573-1:2010 [7:4:4]	
Note on operating/pilot medium	Operation with lubricated medium possible (in which case lubricated operation will always be required)	
Ambient temperature ¹⁾	[°C]	+5 ... +60
Corrosion resistance class CRC ²⁾	2	

- 1) Note operating range of proximity sensors
- 2) Corrosion resistance class CRC 2 to Festo standard FN 940070
Moderate corrosion stress. Indoor applications in which condensation may occur. External visible parts with primarily decorative requirements for the surface and which are in direct contact with the ambient atmosphere typical for industrial applications.

Radial grippers HGRT, heavy-duty

Technical data

Materials

Sectional view

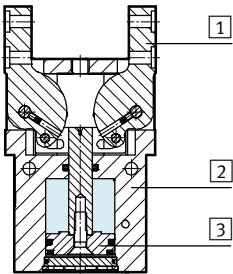

Radial gripper

1	Gripper jaw	Hardened steel
2	Housing	Smooth anodised aluminium
3	Piston	Anodised aluminium
-	Seals	Polyurethane, nitrile rubber
-	Note on materials	Free of copper and PTFE RoHS-compliant

Total gripping torque at 6 bar

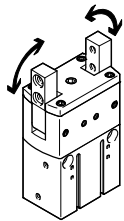

The gripping torque is not constant within the opening angle → 12.

Size		16	20	25	32	40	50
Opening	[Ncm]	188	588	1348	2024	3892	8,24
Closing	[Ncm]	158	516	1208	1856	3526	7754

Static characteristic load values at the gripper jaws

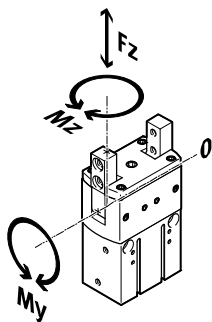

The indicated permissible forces and torques apply to a single gripper jaw. The indicated values include the lever arm, additional applied loads caused by the workpiece or external gripper

fingers, as well as forces which occur during movement.

The zero co-ordinate line (gripper jaw guide) must be taken into consideration for the calculation of torques.

Size		16	20	25	32	40	50
Max. permissible force F_z	[N]	50	100	180	280	400	1200
Max. permissible torque M_y	[Nm]	3.9	6.2	10	13.5	17.5	35
Max. permissible torque M_z	[Nm]	0.3	0.5	1	1.3	1.6	10

Radial grippers HGRT, heavy-duty

Technical data

Mass moment of inertia [kgm²x10⁻⁴]

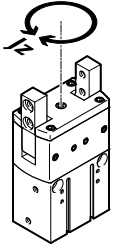

Mass moment of inertia of the radial gripper referred to the central axis, without external gripper fingers, without load.

Size	16	20	25	32	40	50	
HGRT	-	0.191	0.74	2.1	4.62	13.87	43.39
	G2	0.21	0.81	2.33	5.03	15.26	47.70

Opening and closing times [ms] at 6 bar

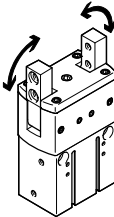

The indicated opening and closing times [ms] have been measured at room temperature and 6 bar operating pressure with vertically mounted gripper and without external gripper fingers.

The grippers must be throttled for greater applied loads. Opening and closing times must then be adjusted accordingly.

Size	16	20	25	32	40	50		
Without external gripper fingers								
HGRT	-	Opening	246	280	309	359	283	350
	-	Closing	293	308	343	403	320	403
HGRT	G2	Opening	233	372	443	503	370	490
	G2	Closing	185	295	301	337	270	355

Radial grippers HGRT, heavy-duty

Technical data

Permissible mass moment of inertia J with external gripper fingers as a function of opening and closing times t at 6 bar

HGRT-16-A

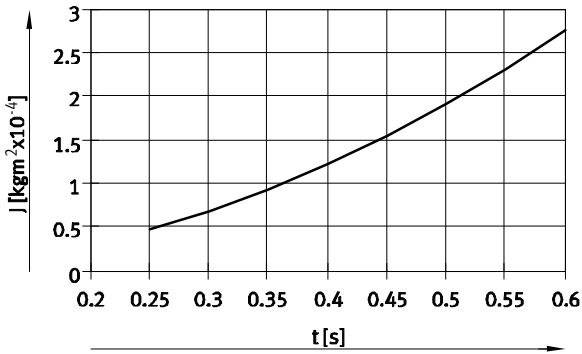

HGRT-20-A

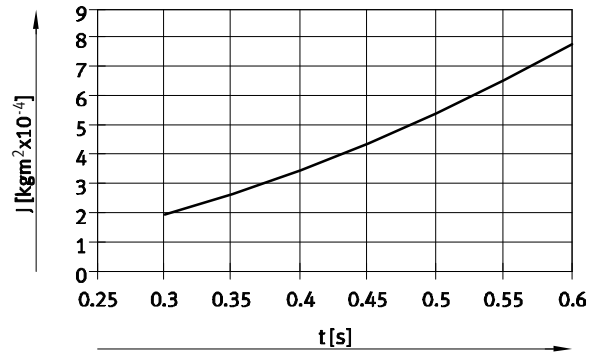

HGRT-25-A

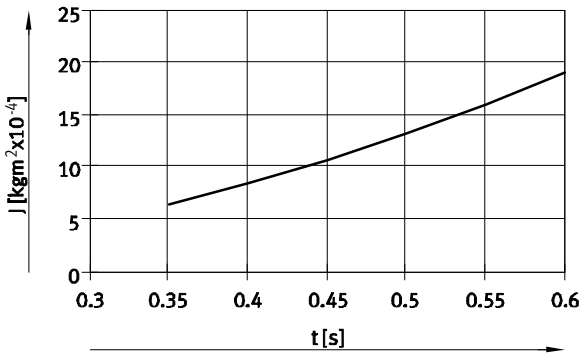

HGRT-32-A

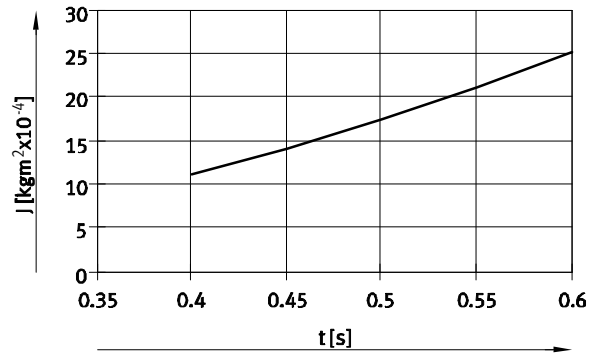

HGRT-40-A

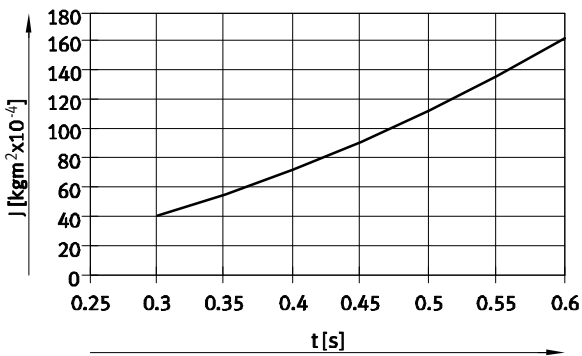

HGRT-50-A

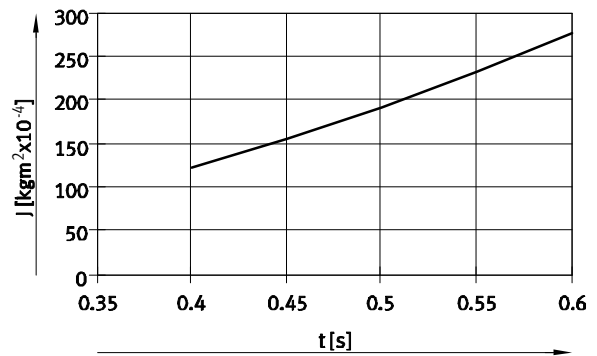

Radial grippers HGRT, heavy-duty

Technical data

Gripping force F_H per gripper jaw as a function of operating pressure and lever arm x

Gripping forces as a function of the operating pressure and the lever arm can be determined for the size using the following graph.

The gripping torque is not constant within the opening angle → 12.

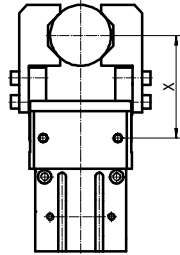

External gripping (closing)

HGRT-16-A

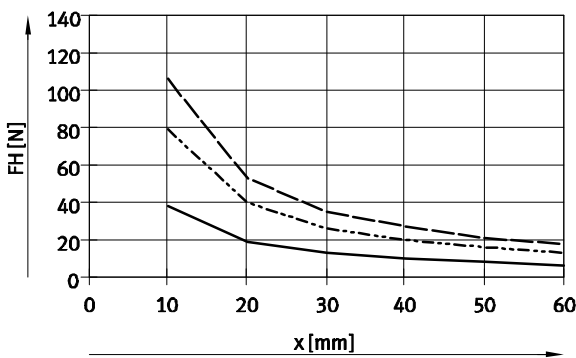

HGRT-20-A

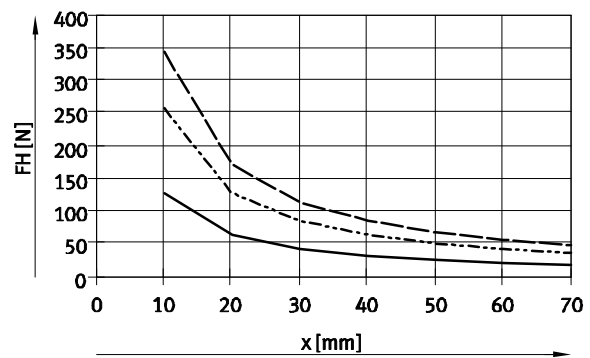

HGRT-25-A

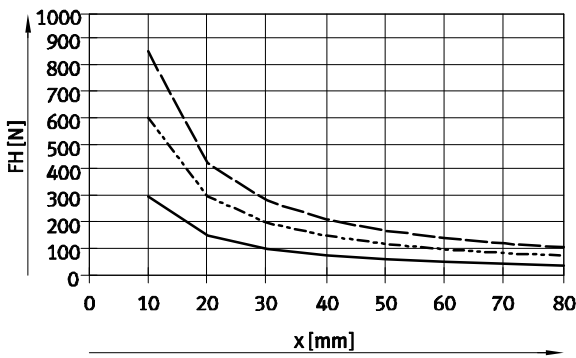

HGRT-32-A

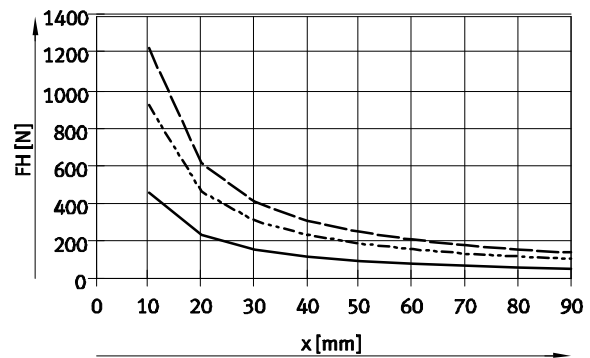

HGRT-40-A

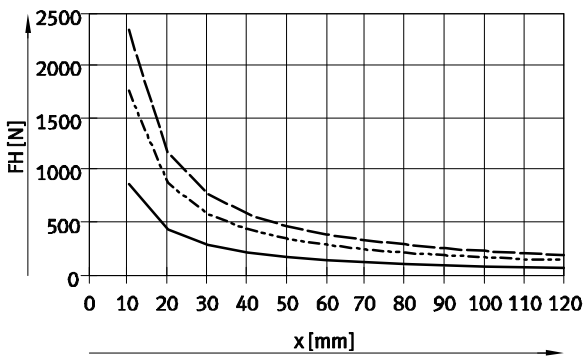

HGRT-50-A

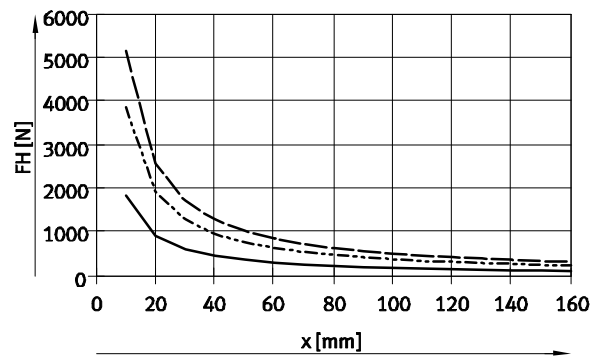

- 3 bar
- - - 6 bar
- · - 8 bar

Radial grippers HGRT, heavy-duty

Technical data

Gripping force F_H per gripper jaw as a function of operating pressure and lever arm x

Gripping forces as a function of the operating pressure and the lever arm can be determined for the size using the following graph.

The gripping torque is not constant within the opening angle → 12.

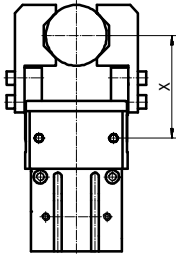

Internal gripping (opening)

HGRT-16-A

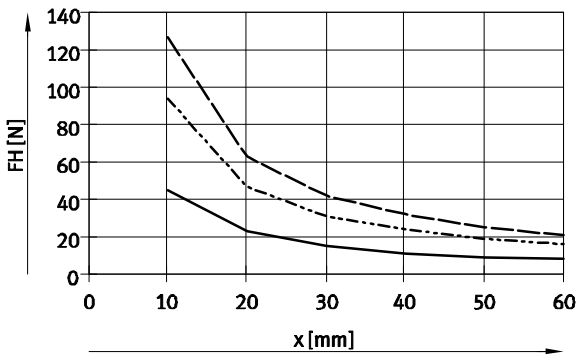

HGRT-20-A

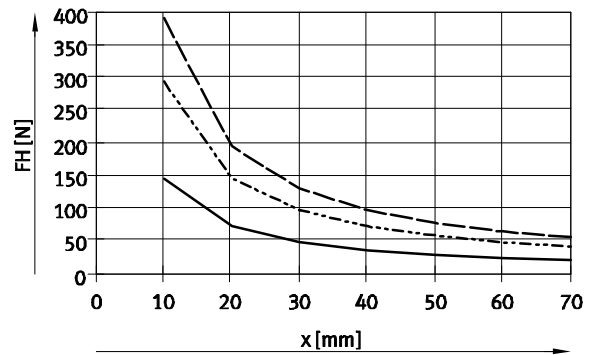

HGRT-25-A

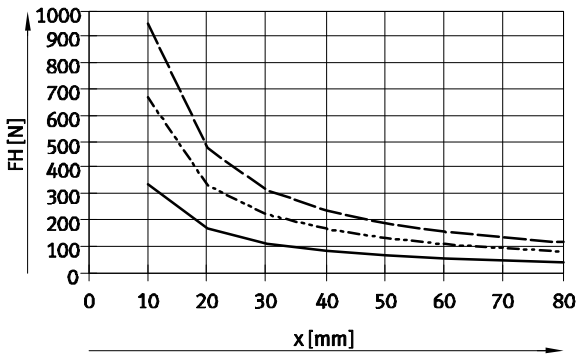

HGRT-32-A

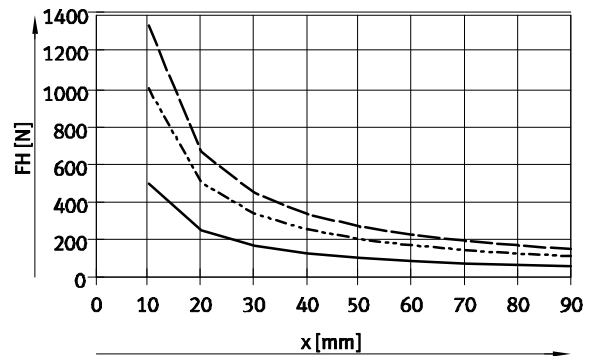

HGRT-40-A

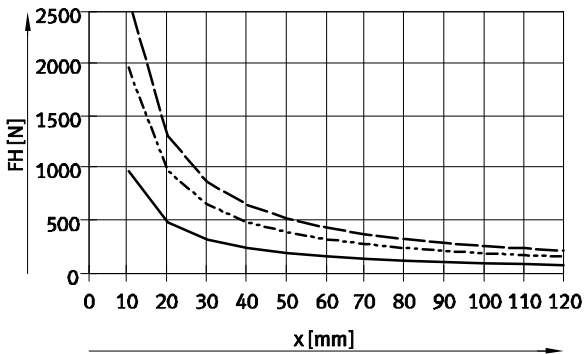

HGRT-50-A

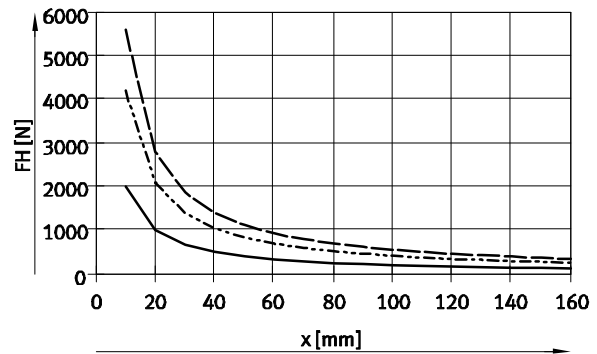

- 3 bar
- - - 6 bar
- · - 8 bar

Radial grippers HGRT, heavy-duty

Technical data

Gripping force F_H per gripper jaw at 6 bar as a function of lever arm x and eccentricity a and b

The following formula must be used to calculate the lever arm x with eccentric gripping:

$$x = \sqrt{a^2 + b^2}$$

The gripping force F_H can be read from the graphs (→ from page 10) using the calculated value x .

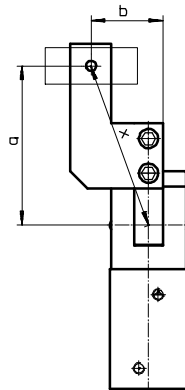

Calculation example

Given:
 Distance $a = 45 \text{ mm}$
 Distance $b = 40 \text{ mm}$
 To be calculated:
 The gripping force at 6 bar,
 with an HGRT-40,
 used as an external gripper

Procedure:
 Calculating the lever arm x
 $x = \sqrt{45^2 + 40^2}$
 $x = 60 \text{ mm}$

The graph (→ 10) gives a value of F_H
 $= 300 \text{ N}$ for the gripping force.

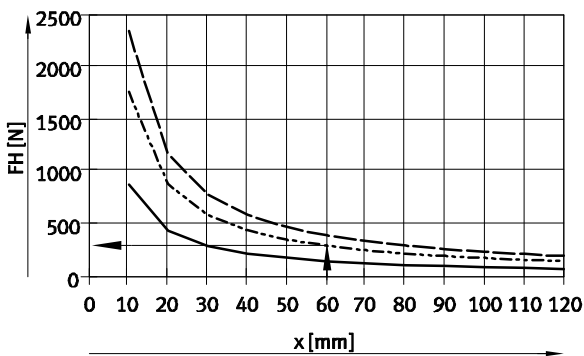

Torque curve M as a function of opening angle α

The drive principle of the gripper jaws means that the torque is not constant within the opening angle. The percentage of torque available in each case can be seen in the graph. An opening angle of 0° means a parallel gripper jaw position.

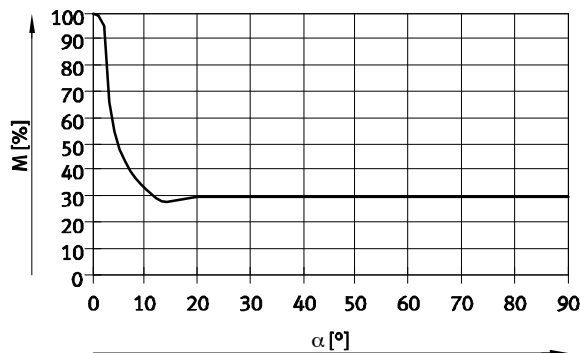

Radial grippers HGRT, heavy-duty

Technical data

Spring torque M_F as a function of opening angle α

HGRT-16 ... 25

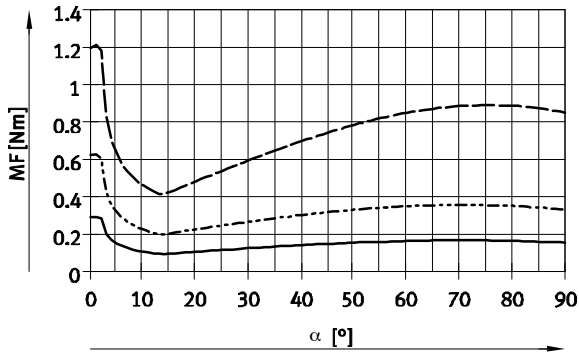

- HGRT-16-A-G2
- - - HGRT-20-A-G2
- · - HGRT-25-A-G2

HGRT-32 ... 40

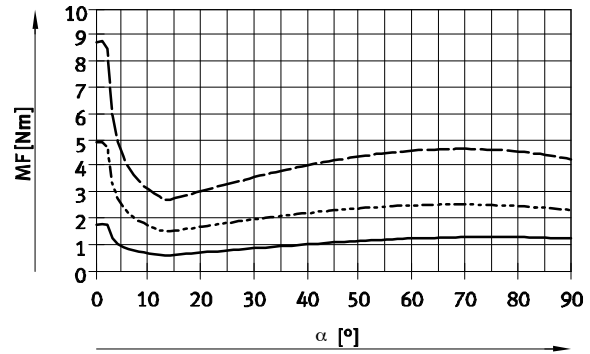

- HGRT-32-A-G2
- - - HGRT-40-A-G2
- · - HGRT-50-A-G2

Determining the actual gripping torques $M_{Grtotal}$ for HGRT-...-G2 as a function of the application

The radial gripper with integrated spring, HGRT-...-G2 (closing gripping force retention), can be used as a:

- Single-acting gripper
- Gripper with supplementary gripping force
- Gripper with gripping force retention

To calculate the available gripping torque $M_{Grtotal}$ (per gripper jaw), the data from the graphs for the gripping force F_H (→ 10/11), the torque curve

M (→ 12) and the spring torque M_F (→ 13) must be combined accordingly.

$$M_{Gr} = F_H * x * M \text{ [%]}$$

- M_{Gr} Gripping torque
- F_H Gripping force
- x Lever arm
- M Torque curve

Application

Single-acting

- Gripping with spring force:
 $M_{Grtotal} = M_F$
- Gripping with pressure force:
 $M_{Grtotal} = M_{Gr} - M_F$

Supplementary gripping force

- Gripping with pressure and spring force:
 $M_{Grtotal} = M_{Gr} + M_F$

Gripping force retention

- Gripping with spring force:
 $M_{Grtotal} = M_F$

Radial grippers HGRT, heavy-duty

Technical data

FESTO

Dimensions

Download CAD data → www.festo.com

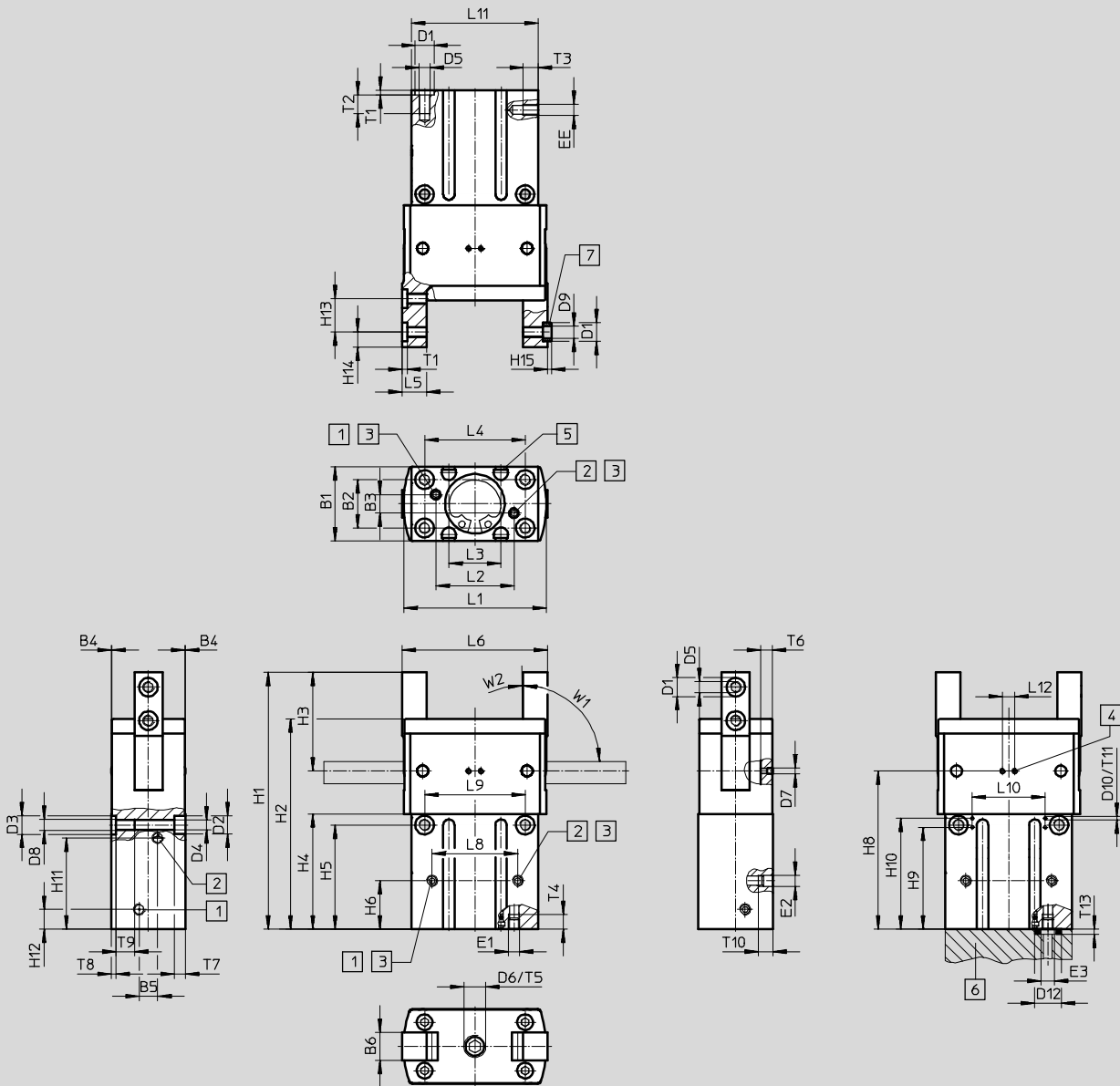

HGRT-32 ... 50

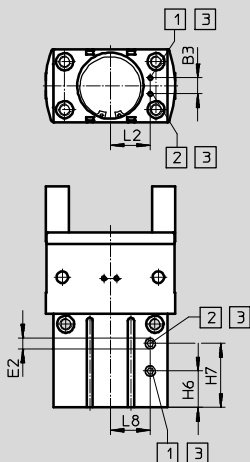

- 1 Supply port, opening
- 2 Supply port, closing
- 3 Alternative supply port, sealed on delivery
- 4 Sealing air, sealed on delivery

- 5 Sensor slot for proximity sensor
- 6 O-ring for radial gripper
HGRT-16 ... 25: \varnothing 3x1.5
HGRT-32 ... 50: \varnothing 5x1.5
- 7 Centring sleeves ZBH
(4 included in the scope of delivery)

Radial grippers HGRT, heavy-duty

Technical data

Size	B1	B2 ¹⁾	B3	B4	B5	B6	D1 ∅	D2 ∅	D3 ∅	D4 ∅	D5	D6	D7	D8	D9 ∅
[mm]	±0.05		±0.1	+0.05	±0.1	±0.05	H8	+0.1	H8						
16	20	13	5	0.2	5	7.5	5	4.9	5	2.6	M3	M6	-	M3	3.2
20	28	18	6	0.2	6	10	7	7.4	7	4.2	M5	M6	M3	M5	5.3
25	35	23	7	0.2	7	12.5	9	9.4	9	5.1	M6	M8	M5	M6	6.4
32	40	27	10	0.2	10	14.5	9	9.4	9	5.1	M6	M8	M5	M6	6.4
40	50	33	11	0.2	11	18	12	10.4	12	6.8	M8	M8	M5	M8	10.3
50	64	42	14	0.2	14	22.5	15	13.5	15	8.5	M10	M12	M5	M10	12.4

Size	D10	D12	EE	E1	E2	E3	H1		H2		H3	H4		H5	
							±0.05	-G ±0.05	±0.05	-G ±0.05		±0.1	±0.1	-G ±0.1	±0.1
16	-	6	M3	M3	M3	M3	69	77.5	56.5	65	26.5	31	39.5	28	36.5
20	-	6	M5	M3	M3	M3	88.5	97.5	71	80	35.1	39	48	34.5	43.5
25	M3	6	M5	M3	M3	M3	109	120	88	99	42.5	48.3	59.3	42.5	53.5
32	M3	8	M5	M5	M5	M5	125	137	102	114	49	54.7	66.7	49	61
40	M3	8	G ¹ / ₈	M5	G ¹ / ₈	M5	154.6	172.6	122	140	63.6	65.5	83.5	58	76
50	M3	8	G ¹ / ₈	M5	G ¹ / ₈	M5	193.5	215.5	153	175	79.5	82.4	104.4	73	95

Size	H6		H7		H8		H9		H10		H11		H12	H13 ¹⁾
	±0.1	-G ±0.1	±0.1	-G ±0.1		-G	±0.1	-G ±0.1	±0.1	-G ±0.1	±0.1	-G ±0.1		
16	13	13	-	-	-	-	-	-	-	-	24.5	33	5.3	9
20	16	16	-	-	52.5	61.5	-	-	-	-	29	38	6	12
25	19.5	19.5	-	-	65.5	76.5	28	39	36	47	36	47	7.6	14
32	20	20	35.5	46.5	75.5	87.5	34.5	46.5	42.5	54.5	42.4	54.2	8.1	16
40	26	29	45	56.5	90	108	47	65	55	73	48	64.5	9.7	20
50	32	32	56	70	113	135	72	94	80	102	62	80	13.5	25

Size	H14 ¹⁾	H15	L1	L2	L3	L4 ¹⁾	L5	L6	L8	L9 ¹⁾	L10	L11	L12	T1
[mm]		-0.3	±0.05		+0.1		±0.05	±0.5	±0.1		±0.1	±0.1		+0.1
16	4	1.2	38.3	21±0.1	14	27	6.5	39	23	27	-	34	-	1.3
20	5	1.4	49.9	30±0.1	17	34	9	50.4	30	34	-	44	11	1.6
25	6	1.9	61.1	39±0.1	22	42	11	61.2	39	41	33	54	11	2.1
32	7	1.9	72.2	22.5 ^{+0.1}	24	51	12	72.2	22.5	48	41	64	11	2.1
40	9	2.4	90.3	28 ^{+0.1}	32	63	16.5	90.8	28	62	47	80	11	2.6
50	11	2.9	113.2	35 ^{+0.1}	36	80	20	113	35	78	59	100	11	3.1

Size	T2		T3	T4	T5	T6	T7	T8	T9	T10	T11	T12	T13	W1	W2
	min.	-G min.													
16	5	5	4	4	4	-	3.1	1.3	5	4	-	-	1.2	90	1
20	8.5	8	5	4	5	4.3	4.1	1.6	8	4	-	4	1.2	90	1
25	10	10	5	4.5	6	5.8	5.1	2.1	10	4.5	5.5	-	1.2	90	1
32	9.5	9.5	5	5	7	6.3	5.2	2.1	9.5	5	5.5	-	1.2	90	1
40	14.5	14.5	8.5	5	8	7.8	6.2	2.6	12.5	8.5	5.5	-	1.2	90	1
50	15	15	8.5	5	10	10.55	8.1	3.1	15	8.5	5.5	-	1.2	90	1

1) Tolerance for centring hole ±0.02 mm
Tolerance for thread ±0.1 mm

Radial grippers HGRT, heavy-duty

Technical data

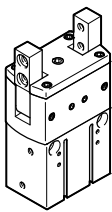
Ordering data					
	Size	Double-acting without compression spring		Single-acting or with gripping force retention, closing	
	[mm]	Part No.	Type	Part No.	Type
	16	563904	HGRT-16-A	563905	HGRT-16-A-G2
	20	563906	HGRT-20-A	563907	HGRT-20-A-G2
	25	563908	HGRT-25-A	563909	HGRT-25-A-G2
	32	563910	HGRT-32-A	563911	HGRT-32-A-G2
	40	563912	HGRT-40-A	563913	HGRT-40-A-G2
	50	563914	HGRT-50-A	563915	HGRT-50-A-G2

Ordering data – Wearing parts kits		
Size	Part No.	Type
[mm]		
16	1459481	HGRT-16
20	1459482	HGRT-20
25	1459483	HGRT-25
32	1459484	HGRT-32
40	1459485	HGRT-40
50	1459486	HGRT-50

Radial grippers HGRT



Accessories



Adapter kit
DHAA, HAPG

Material:
Wrought aluminium alloy
Free of copper and PTFE
RoHS-compliant

 Note
The kit includes the individual mounting interface as well as the necessary mounting material.

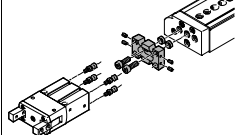
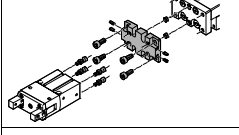
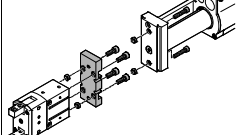
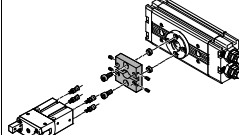
Permissible drive/gripper combinations with adapter kit					Download CAD data → www.festo.com		
Combination	Drive Size	Gripper		Adapter kit			
		Size	Mounting option		CRC ¹⁾	Part No.	Type
							
DGSL/HGRT	DGSL	HGRT		DHAA			
	8, 10	16	■	■	2	1273902 DHAA-G-G6-8-B11-16	
	12, 16	16	■	■		1467524 DHAA-G-G6-12-B11-16	
	12, 16	20	■	■		1278364 DHAA-G-G6-12-B11-20	
	20, 25	25	■	■		1468307 DHAA-G-G6-20-B11-25	
	25	32	■	■		1280494 DHAA-G-G6-25-B11-32	
SLT/HGRT	SLT	HGRT		DHAA			
	10	16	■	–	2	1274402 DHAA-G-G3-10-B11-16	
	16	20	■	–		1278980 DHAA-G-G3-16-B11-20	
	20	25	■	–		1279954 DHAA-G-G3-20-B11-25	
	25	32	■	–		1280734 DHAA-G-G3-25-B11-32	
	25	40	■	–		1281448 DHAA-G-G3-25-B11-40	
HMP/HGRT	HMP	HGRT		DHAA			
	16	25	–	■	2	1279797 DHAA-G-H2-16-B11-25	
	20	32	–	■		1280562 DHAA-G-H2-20-B11-32	
	25	32	–	■		1471637 DHAA-G-H2-25-B11-32	
	20	40	–	■		1281049 DHAA-G-H2-20-B11-40	
	25	40	–	■		1472239 DHAA-G-H2-25-B11-40	
DRQD/HGRT	DRQD	HGRT		DHAA			
	16	16	■	■	2	1273999 DHAA-G-Q5-16-B11-16	
	20	20	■	■		1465263 DHAA-G-Q5-20-B11-20	
	25, 32	25	■	■		1279439 DHAA-G-Q5-25-B11-25	
	25, 32 ²⁾	25	■	■		1468974 DHAA-G-Q5-25-E-B11-25	
	25, 32	32	■	■		1468949 DHAA-G-Q5-25-B11-32	
	25, 32 ²⁾	32	■	■		1468980 DHAA-G-Q5-25-E-B11-32	
	32	40	■	■		1280996 DHAA-G-Q5-32-B11-40	

1) Corrosion resistance class 2 according to Festo standard 940 070
Components subject to moderate corrosion stress. Externally visible parts with primarily decorative surface requirements which are in direct contact with a normal industrial environment or media such as coolants or lubricating agents.

2) In combination with DRQD-...-E444 (flanged shaft with energy through-feed).

Radial grippers HGRT



Accessories



Adapter kit
DHAA, HAPG

Material:
Wrought aluminium alloy
Free of copper and PTFE
RoHS-compliant

 Note
The kit includes the individual mounting interface as well as the necessary mounting material.

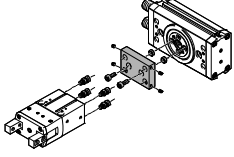
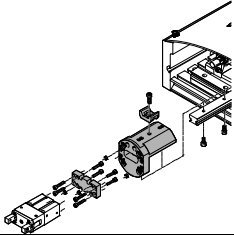
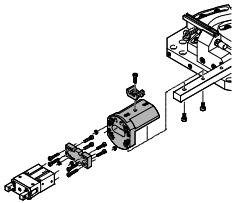
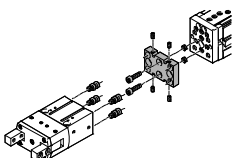
Permissible drive/gripper combinations with adapter kit							Download CAD data → www.festo.com	
Combination	Drive Size	Gripper			Adapter kit			
		Size	Mounting option		CRC ¹⁾	Part No.	Type	
								
	DRRD	HGRT			2	DHAA		
	16	16	■	■		2185606	DHAA-G-Q11-16-B11-16	
	20	20	■	■		2184467	DHAA-G-Q11-20-B11-20	
	25	25	■	■		1741183	DHAA-G-Q11-25-B11-25	
	25	32	■	■		1743177	DHAA-G-Q11-25-B11-32	
	32	25	■	■		2184080	DHAA-G-Q11-32-B11-25	
	32	32	■	■		2184322	DHAA-G-Q11-32-B11-32	
	32	40	■	■		2184652	DHAA-G-Q11-32-B11-40	
35	40	■	■	2185436	DHAA-G-Q11-35-B11-40			
	HSP	HGRT			2	DHAA, HAPG		
	16	16	■	–		1274347	DHAA-G-H4-16-B11-16	
	25	16	■	–		540882	HAPG-71-B	
						1274347	DHAA-G-H4-16-B11-16	
					540883	HAPG-72-B		
	HSW	HGRT			2	DHAA, HAPG		
	12, 16	16	■	–		1274347	DHAA-G-H4-16-B11-16	
						540882	HAPG-71-B	
	EGSL	HGRT			2	DHAA		
	45, 55	20	■	■		1278364	DHAA-G-G6-12-B11-20	
	45, 55	25	■	■		1279418	DHAA-G-E8-45-B11-25	
	75	25	■	■		1468307	DHAA-G-G6-20-B11-25	
	75	32	■	■		1280494	DHAA-G-G6-25-B11-32	

1) Corrosion resistance class 2 according to Festo standard 940 070
Components subject to moderate corrosion stress. Externally visible parts with primarily decorative surface requirements which are in direct contact with a normal industrial environment or media such as coolants or lubricating agents.

Radial grippers HGRT



Accessories



Adapter kit
DHAA, HAPG

Material:
Wrought aluminium alloy
Free of copper and PTFE
RoHS-compliant

 Note
The kit includes the individual mounting interface as well as the necessary mounting material.

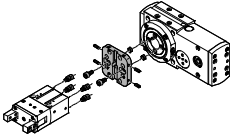
Permissible drive/gripper combinations with adapter kit					Download CAD data → www.festo.com		
Combination	Drive Size	Gripper		Adapter kit			
		Size	Mounting option		CRC ¹⁾	Part No.	Type
							
	ERMB	HGRT			DHAA		
	20	20	■	■	2	1465263	DHAA-G-Q5-20-B11-20
	25, 32	25	■	■		1279439	DHAA-G-Q5-25-B11-25
	25, 32	32	■	■		1468949	DHAA-G-Q5-25-B11-32

1) Corrosion resistance class 2 according to Festo standard 940 070
Components subject to moderate corrosion stress. Externally visible parts with primarily decorative surface requirements which are in direct contact with a normal industrial environment or media such as coolants or lubricating agents.

Radial grippers HGRT

Accessories



Stroke reducing kit HGRT-HR

Materials:

Screw: Steel

Lock nut: Case-hardened steel

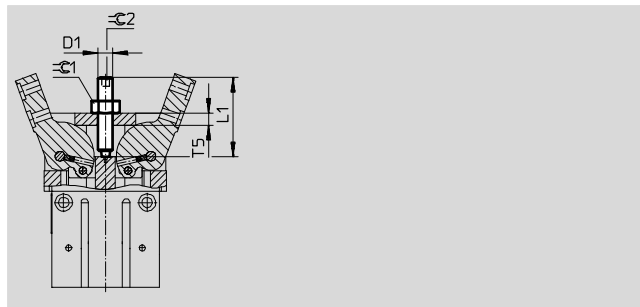

Dimensions and ordering data									
For size	D1	L1	T5	$\approx \varnothing 1$	$\approx \varnothing 2$	Adjustable end-position range	Weight	Part No.	Type
[mm]						[mm]	[g]		
16	M6	26	4	10	3	20	7	564296	HGRT-HR-16
20	M6	31	5	10	3	25	9	564297	HGRT-HR-20
25	M8	36	6	13	4	30	18	564298	HGRT-HR-25
32	M8	41	7	13	4	35	20	564299	HGRT-HR-32
40	M8	51	8	13	4	45	24	564300	HGRT-HR-40
50	M12	61	10	19	6	50	66	564301	HGRT-HR-50

Sensor bracket DASI

Material:

DASI-B10-25-S8: Polyamide

DASI-B10-40-S12: Aluminium

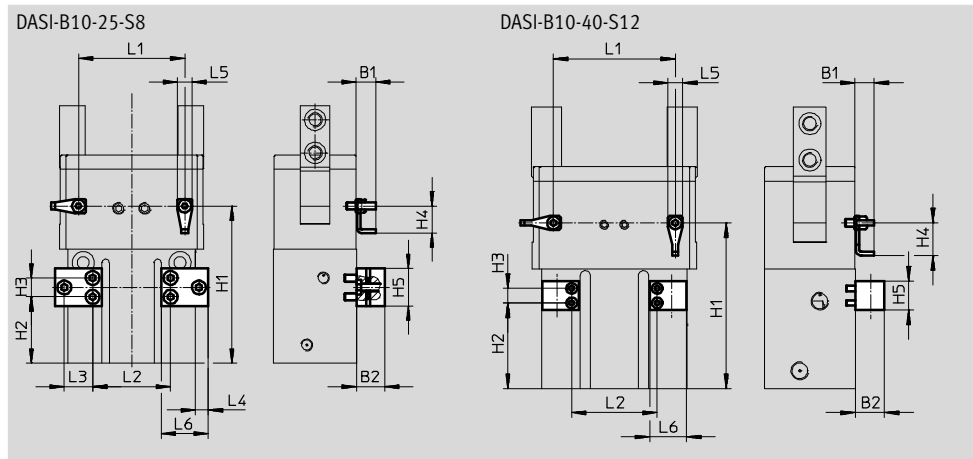
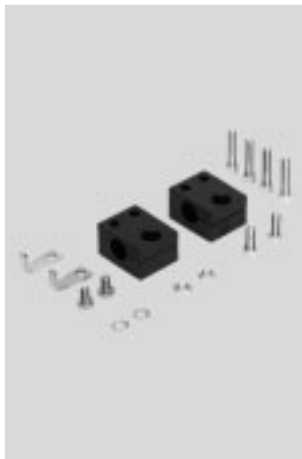

Dimensions and ordering data				
For type	H1	H2	L1	L2
	± 0.02	± 0.1	± 0.01	
HGRT-25-A	66.5	28	45	33
HGRT-25-A-G2	77.5	39	45	33
HGRT-32-A	76	34.5	53	64
HGRT-32-A-G2	88	46.5	53	64
HGRT-40-A	91	47	67	47
HGRT-40-A-G2	109	65	67	47
HGRT-50-A	114	72	84	59
HGRT-50-A-G2	136	94	84	59

For size	B1	B2	H3	H4	H5	L3	L4	L5	L6	Weight	Part No.	Type
[mm]			± 0.1			± 0.1			± 0.2	[g]		
25, 32	8.45	12	8	11.5	16	12	5.5	6	20	39	564311	DASI-B10-25-S8
40, 50	10.5	16	8	18	16	-	-	8	20	18	564312	DASI-B10-40-S12

Radial grippers HGRT

Accessories



FESTO

Ordering data – Centring sleeves			Technical data → Internet: zbh		
	For size [mm]	Part No.	Type	PU ¹⁾	
	16	189652	ZBH-5	10	
	20	186717	ZBH-7		
	25, 32	150927	ZBH-9		
	40	189653	ZBH-12		
	50	191409	ZBH-15		

1) Packaging unit

Ordering data – Proximity sensors for C-slot, magneto-resistive					Technical data → Internet: smt	
	Type of mounting	Electrical connection, connection direction	Switching output	Cable length [m]	Part No.	Type
N/O contact						
	Insertable in the slot lengthwise	Cable, 3-wire, lateral	PNP	2.5	547862	SMT-10G-PS-24V-E-2,5Q-OE
		Plug M8x1, 3-pin, lateral		0.3	547863	SMT-10G-PS-24V-E-0,3Q-M8D

Ordering data – Proximity sensors for T-slot, magneto-resistive					Technical data → Internet: smt	
	Type of mounting	Electrical connection, connection direction	Switching output	Cable length [m]	Part No.	Type
N/O contact						
	Insertable in the slot lengthwise	Cable, 3-wire, lateral	PNP	2.5	547859	SMT-8G-PS-24V-E-2,5Q-OE
		Plug M8x1, 3-pin, lateral		0.3	547860	SMT-8G-PS-24V-E-0,3Q-M8D

Ordering data – Connecting cables				Technical data → Internet: nebu	
	Electrical connection, left	Electrical connection, right	Cable length [m]	Part No.	Type
	Straight socket, M8x1, 3-pin	Cable, open end, 3-wire	2.5	541333	NEBU-M8G3-K-2.5-LE3
			5	541334	NEBU-M8G3-K-5-LE3
	Angled socket, M8x1, 3-pin	Cable, open end, 3-wire	2.5	541338	NEBU-M8W3-K-2.5-LE3
			5	541341	NEBU-M8W3-K-5-LE3

Radial grippers HGRT

Accessories

FESTO

Position transmitter

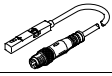
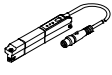

The position transmitter continuously senses the position of the piston.

It has an analogue output with an output signal in proportion to the piston position.

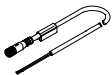
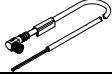
Ordering data – Position transmitters for T-slot							Technical data → Internet: position transmitter		
	For size	Position measuring range	Analogue output		Type of mounting	Electrical connection	Cable length [m]	Part No.	Type
			[V]	[mA]					
	40	0 ... 40	0 ... 10	–	Insertable in slot from above	Plug M8x1, 4-pin, in-line	0.3	553744	SMAT-8M-U-E-0,3-M8D
	50	0 ... 50	–	4 ... 20	Insertable in slot from above	Plug M8x1, 4-pin, in-line	0.3	1531265	SDAT-MHS-M50-1L-SA-E-0.3-M8

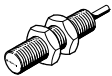
Ordering data – Connecting cables				Technical data → Internet: nebu	
	Electrical connection, left	Electrical connection, right	Cable length [m]	Part No.	Type
	Straight socket, M8x1, 4-pin	Cable, open end, 4-wire	2.5	541342	NEBU-M8G4-K-2.5-LE4
			5	541343	NEBU-M8G4-K-5-LE4
	Angled socket, M8x1, 4-pin	Cable, open end, 4-wire	2.5	541344	NEBU-M8W4-K-2.5-LE4
			5	541345	NEBU-M8W4-K-5-LE4

Ordering data – Proximity sensors, inductive, for sensor bracket DASI				Technical data → Internet: sien	
	Thread	Contact	Connection	Part No.	Type
	For DASI-B10-25-S8				
	M8	N/O contact	Cable, 2.5 m	150386	SIEN-M8B-PS-K-L
			Plug	150387	SIEN-M8B-PS-S-L
	For DASI-B10-40-S12				
M12	N/O contact	Cable, 2.5 m	150402	SIEN-M12B-PS-K-L	
		Plug	150403	SIEN-M12B-PS-S-L	

Ordering data – Connecting cables				Technical data → Internet: nebu	
	Electrical connection, left	Electrical connection, right	Cable length [m]	Part No.	Type
	Straight socket, M8x1, 3-pin	Cable, open end, 3-wire	2.5	541333	NEBU-M8G3-K-2.5-LE3
			5	541334	NEBU-M8G3-K-5-LE3
	Angled socket, M8x1, 3-pin	Cable, open end, 3-wire	2.5	541338	NEBU-M8W3-K-2.5-LE3
			5	541341	NEBU-M8W3-K-5-LE3