

Parallel grippers HGPP, precision



Parallel grippers HGPP, precision

Key features

FESTO

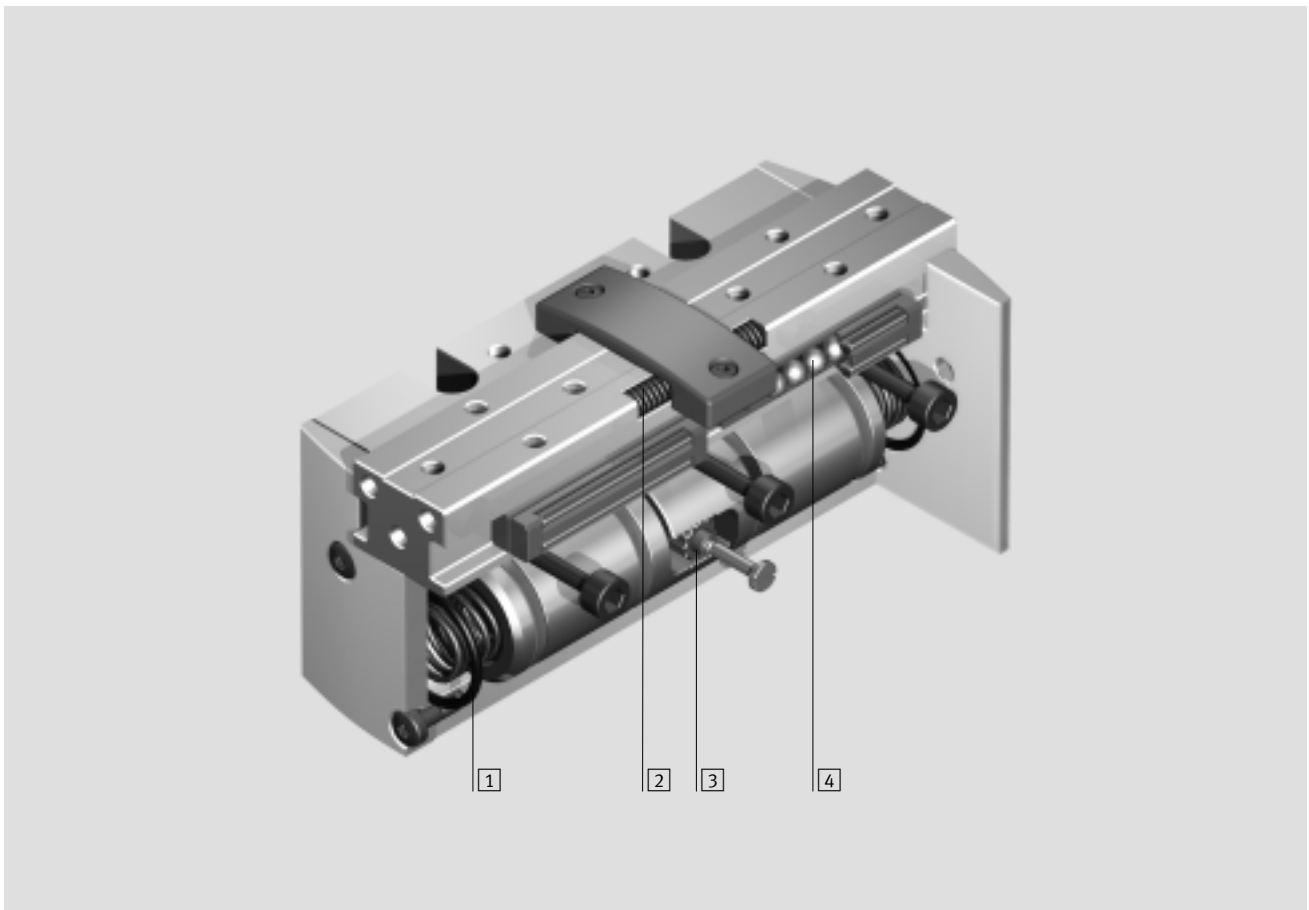

At a glance

- Wide range of variants for greater flexibility:
 - Double-acting piston drive HGPP-...-A.
 - Compression springs for supporting or retaining gripper forces, or for use as a single-acting gripper with only one compressed air connection
 - High precision gripper jaw guide
 - External gripping
 - Internal gripping
 - Multiple compressed air connections
 - Integrated sensing electronics
 - Adaptable proximity sensor via mounting bracket
 - Highly flexible thanks to versatile attachment, mounting and applications options
 - Drives
 - Externally adaptable gripper fingers
 - Guide plate
- 1 Compression spring closes gripper jaws:
HGPP-...-G2
 - 2 Compression spring opens gripper jaws:
HGPP-...-G1
 - 3 Synchronisation element
 - 4 Backlash-free guide bearing

-  - Note

Sizing software
Gripper selection
→ www.festo.com

Parallel grippers HGPP, precision

Features

Versatile air connections and mounting options

Supply port direct at the front, direct mounting from above

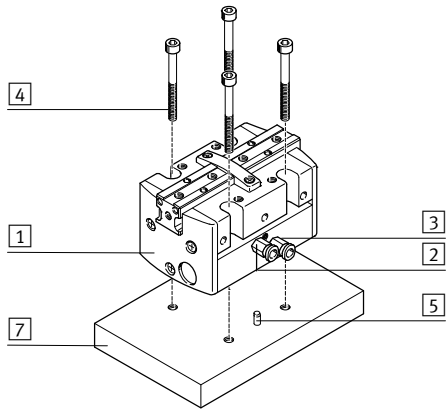

Supply port via adapter plate from underneath, direct mounting from above

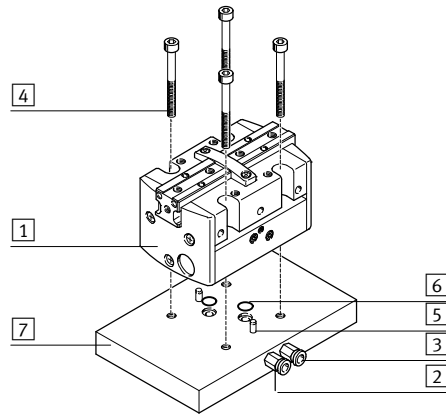

- 1 Parallel gripper
- 2 Compressed air connection, opening
- 3 Compressed air connection, closing
- 4 Mounting screws
- 5 Locating pins
- 6 O-rings
- 7 Plate (user-specific)

Range of applications (user-specific)

Attachment of external gripper fingers

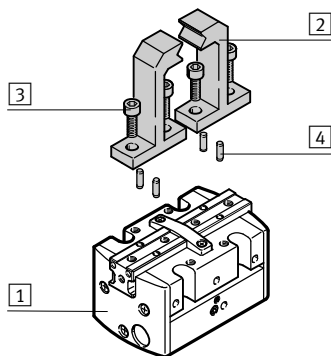

Used as guide plate

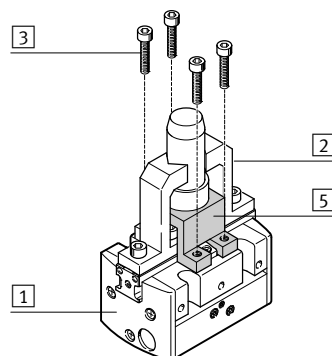

- 1 Parallel gripper
- 2 Gripper finger
- 3 Mounting screws
- 4 Locating pins
- 5 Guide plate

Note
Grippers are not suitable for the following, or for similar applications:

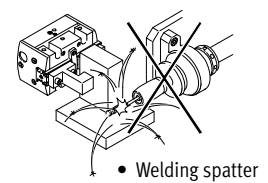
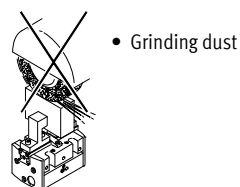
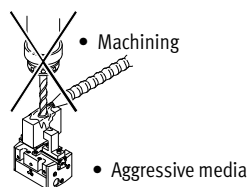

Parallel grippers HGPP, precision

System example

FESTO

System product for handling and assembly technology

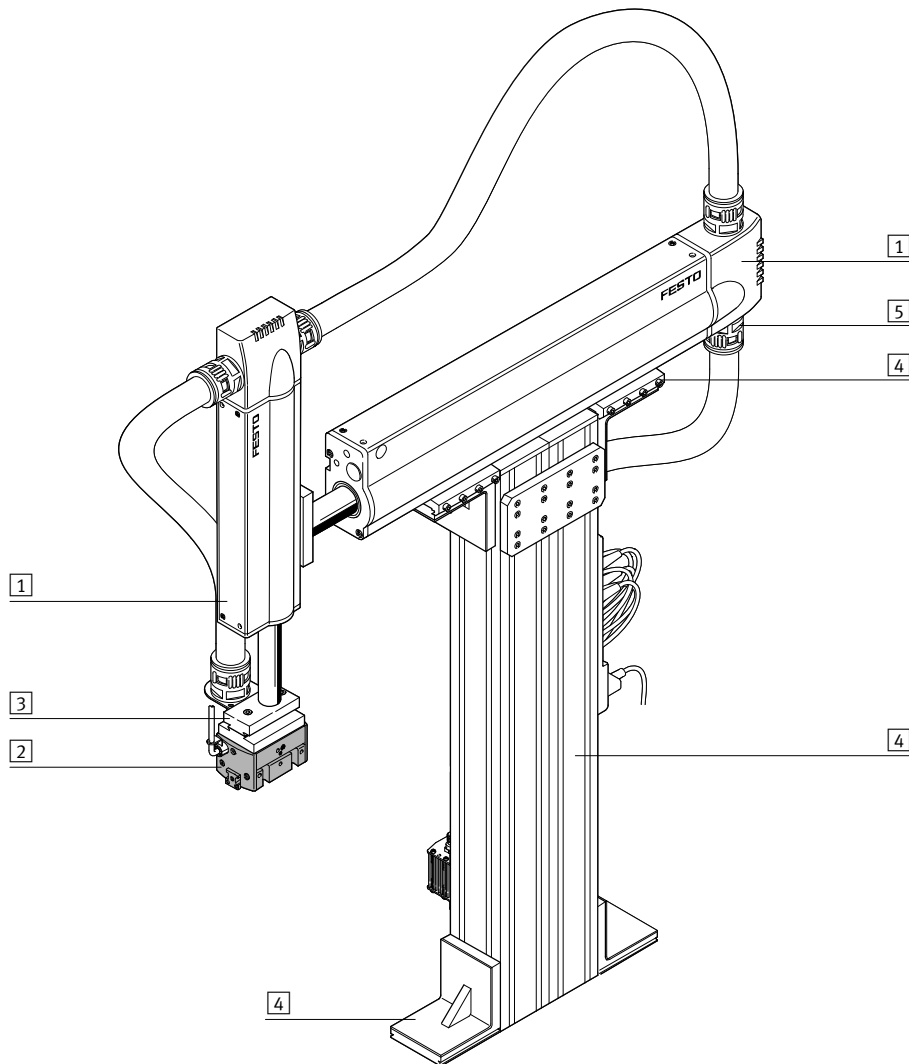

System elements and accessories		
	Brief description	→ Page/Internet
1	Drives	Wide range of combination options within handling and assembly technology
2	Gripper	Diverse variation options in handling and assembly technology
3	Adapter	For drive/drive and drive/gripper connections
4	Basic mounting components	Profiles and profile connections as well as profile/drive connections
5	Installation components	For achieving a clear-cut, safe layout of electrical cables and tubing
-	Axes	Diverse possible combinations in handling and assembly technology
-	Motors	Servo and stepper motors, with or without gearing

Parallel grippers HGPP, precision

Peripherals overview and type codes

Peripherals overview

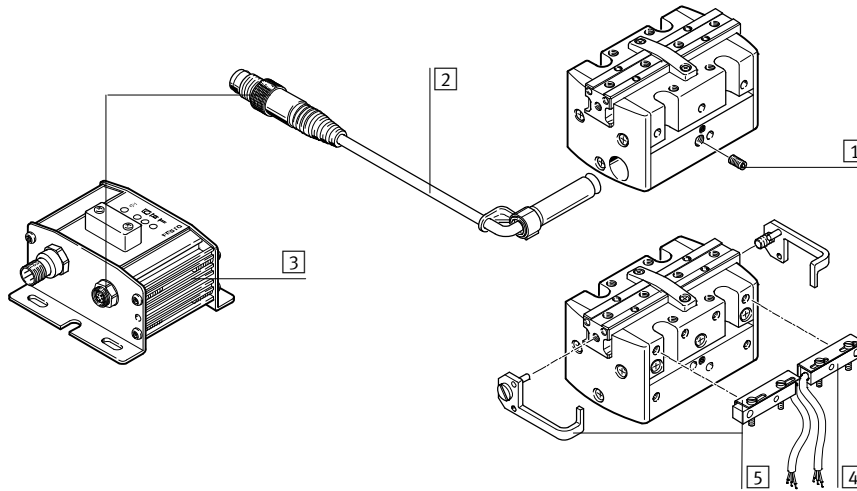

Accessories		
	Brief description	→ Page/Internet
1	Threaded pin For mounting proximity sensors SMH-S1	–
2	Position sensor SMH-S1 Can be integrated in the gripper	14
3	Evaluation unit SMH-AE1 For proximity sensor SMH-S1, for sensing 3 positions	14
4	Proximity sensor SIES-Q5B Can be assembled with mounting bracket HGPP-HWS-Q5	14
5	Mounting bracket HGPP-HWS-Q5 For mounting proximity sensors SIES-Q5B, comprising 1 bracket and 1 switch lug with mounting screws	15
–	Adapter kit HMSV, HAPG Drive/gripper connections	16

Type codes

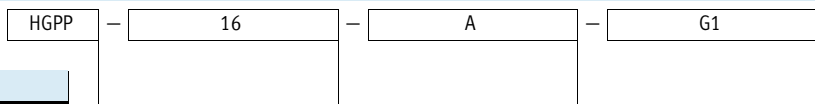

Type	
HGPP	Parallel gripper

Size	

Position sensing	
A	Via proximity sensor

Gripping force backup	
G1	Opening
G2	Closing

Parallel grippers HGPP, precision

Technical data

Function
Double-acting
HGPP-...-A

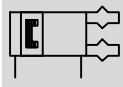

Single-acting or
with gripping force retention ...
... opening HGPP-...-G1



... closing HGPP-...-G2



⌀ - Size
10 ... 32 mm

— | - Stroke
4 ... 25 mm

www.festo.com
Wearing parts kits
➔ 14



General technical data						
Size	10	12	16	20	25	32
Design	Rack and pinion					
Mode of operation	Double-acting					
Gripper function	Parallel					
Number of gripper jaws	2					
Max. load per external gripper finger ¹⁾ [g]	< 50	< 100	< 150	< 200	< 250	< 300
Stroke per gripper jaws [mm]	2	2.5	5	7.5	10	12.5
Pneumatic connection	M3		M5		G1/8/M5 ²⁾	
Repetition accuracy ³⁾ [mm]	< 0.02	< 0.015		< 0.01	< 0.02	
Max. interchangeability [mm]	0.2					
Max. gripper jaw backlash [mm]	0					
Max. gripper jaw angular lash [°]	0					
Max. operating frequency [Hz]	4					
Centring precision [mm]	< ∅ 0.05					
Position sensing	For proximity sensing					
Type of mounting	With through-hole and locating pin With female thread and locating pin					

- 1) Valid for unthrottled operation
- 2) Supply port on side G1/8; supply port on ground M5
- 3) End-position drift under constant conditions of use with 100 consecutive strokes in the direction of movement of the gripper jaws
- | - Note: This product conforms to ISO 1179-1 and to ISO 228-1

Operating and environmental conditions		
Min. operating pressure	HGPP-...-A [bar]	2
	HGPP-...-G... [bar]	5
Max. operating pressure [bar]		8
Operating medium		Compressed air in accordance with ISO 8573-1:2010 [7:4:4]
Note on operating/pilot medium		Operation with lubricated medium possible (in which case lubricated operation will always be required)
Ambient temperature ¹⁾ [°C]		+5 ... +60
Corrosion resistance class CRC ²⁾		2

- 1) Note operating range of proximity sensors
- 2) Corrosion resistance class 2 according to Festo standard 940 070
Components requiring moderate corrosion resistance. Externally visible parts with primarily decorative surface requirements which are in direct contact with a surrounding industrial atmosphere or media such as cooling or lubricating agents

Parallel grippers HGPP, precision

Technical data

FESTO

Weights [g]						
Size	10	12	16	20	25	32
HGPP-...-A	126	172	315	604	884	1,408
HGPP-...-G1	127	173	316	611	910	1,438
HGPP-...-G2	127	173	317	615	898	1,427

Materials

Sectional view

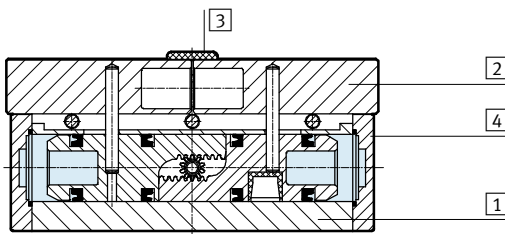

Parallel gripper	
1	Housing Anodised aluminium
2	Gripper jaw Nickel-plated aluminium
3	Cover cap Polyacetate
4	Plug cap Anodised aluminium
-	Note on material Free of copper, PTFE and silicone Conforms to RoHS

Gripping force [N] at 6 bar

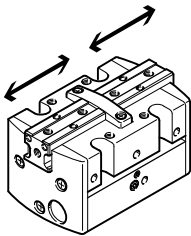

Size	10	12	16	20	25	32
Gripping force per gripper jaw						
Opening	40	58	102	170	250	415
Closing	40	58	102	170	250	415
Total gripping force						
Opening	80	116	204	340	500	830
Closing	80	116	204	340	500	830

Characteristic load values at the gripper jaws

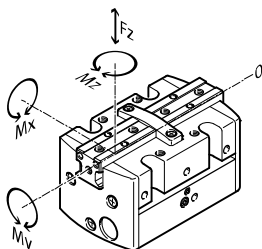

Indicated permissible forces and torques apply to a single gripper jaw. Static forces and torques relate to additional applied loads caused by the workpiece or external gripper fingers, as well as forces which occur

during handling. The zero co-ordinate line (gripper jaws point of rotation) must be taken into consideration for the calculation of torques. Additionally, max. permissible forces

which may be applied to the housing have been entered as well, which, for example, can be absorbed by a guide plate during pressing-in operations.

Size	10	12	16	20	25	32
Max. permissible force $F_{Z\text{Gripper jaws}}$ [N]	40	70	130	220	380	720
Max. permissible force $F_{Z\text{Housing}}$ [N]	200	400	600	800	1,000	1,200
Max. permissible torque M_x [Nm]	1.5	3	7	14	21	30
Max. permissible torque M_y [Nm]	1.5	3	7	14	21	30
Max. permissible torque M_z [Nm]	1.5	3	7	14	21	30

Parallel grippers HGPP, precision

Technical data



Mass moment of inertia [kgm²x10⁻⁴]

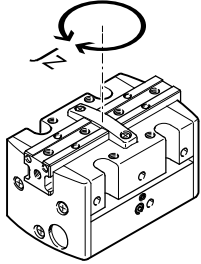

Mass moment of inertia [kgm²x10⁻⁴]
for parallel grippers in relation to the
central axis, without load.

Size	10	12	16	20	25	32
HGPP-...A	0.43	0.73	2.39	6.22	16.68	38.34
HGPP-...G1	0.45	0.76	2.58	6.71	17.45	39.21
HGPP-...G2	0.43	0.74	2.45	6.27	16.85	38.63

Opening and closing times [ms] at 6 bar

without external gripper fingers

with external gripper fingers

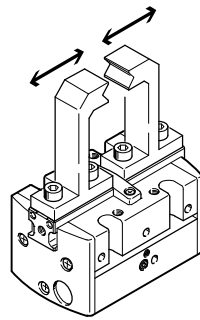
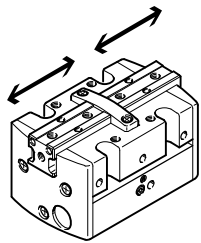

The indicated opening and closing times [ms] have been measured at room temperature and 6 bar operating pressure with vertically mounted gripper and without external gripper fingers. Load [g] is increased if external gripper fingers are attached. This means that kinetic energy is also increased, as this is determined by gripper finger weight and velocity. If permissible kinetic energy is exceeded, various parts of the gripper may be damaged. This occurs when

the applied load reaches the end-position and the cushioning is only able to partially convert the kinetic energy into potential energy and heat energy. It thus becomes apparent that the indicated max. permissible applied load due to the external gripper fingers must be checked and maintained. The grippers must be throttled for greater applied loads. Opening and closing times must then be adjusted accordingly.

Size		10	12	16	20	25	32
Without external gripper fingers							
HGPP-...A	Opening	22	27	40	44	64	76
	Closing	34	40	53	59	92	110
HGPP-...G1	Opening	24	30	34	45	58	64
	Closing	95	70	70	92	164	173
HGPP-...G2	Opening	26	37	57	62	105	103
	Closing	32	40	46	58	90	101
With external gripper fingers as a function of the load							
HGPP	100 g	100	–	–	–	–	–
	200 g	200	100	50	–	–	–
	300 g	300	200	100	50	100	–
	400 g	–	300	200	100	150	100
	500 g	–	–	300	200	200	150
	600 g	–	–	–	–	300	250

Parallel grippers HGPP, precision

Technical data

Gripping force F_H as a function of operating pressure and the lever arm x

Gripping forces related to operating pressure and lever arm can be determined for the various sizes with the following graphs.

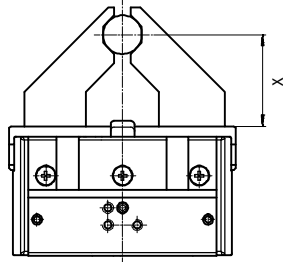

HGPP-10-A

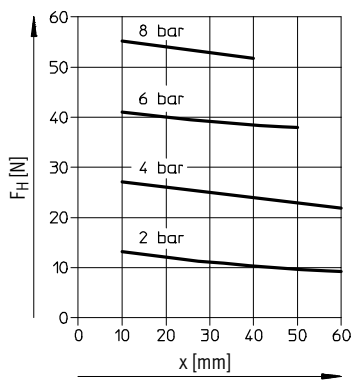

HGPP-12-A

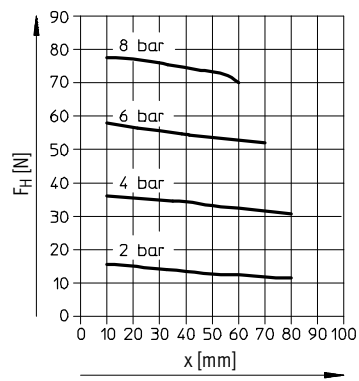

HGPP-16-A

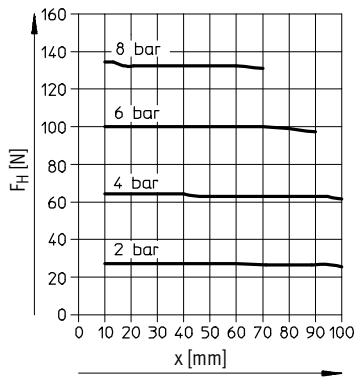

HGPP-20-A

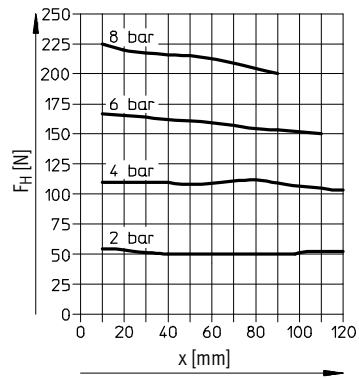

HGPP-25-A

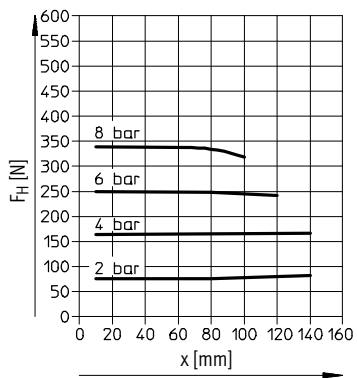

HGPP-32-A

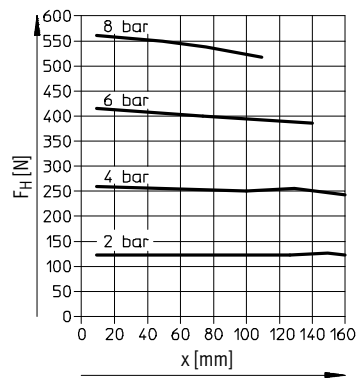

Parallel grippers HGPP, precision

Technical data

Spring force F_F as a function of the gripper size and overall stroke length l

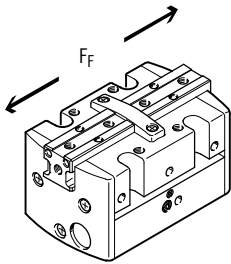

Gripper retention force, opening: the spring forces F_F of the parallel gripper HGPP...-G1 can be determined from the following graphs.

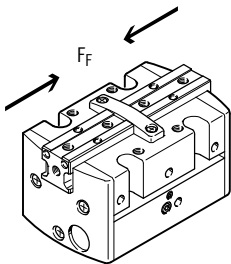
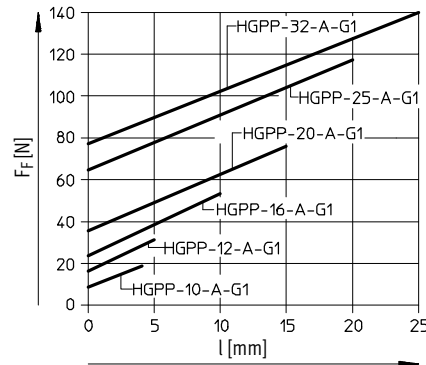

Gripper retention force, closing: the spring forces F_F of the parallel gripper HGPP...-G2 can be determined from the following graphs.

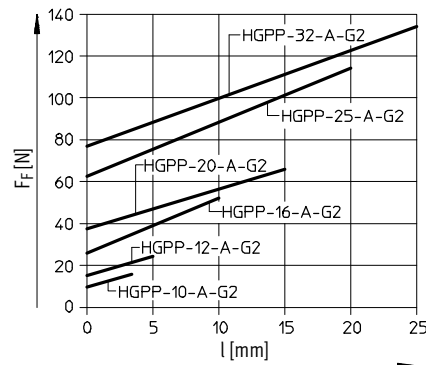

Determination of actual gripping forces for HGPP...-G1 and HGPP...-G2 depending upon the application

The parallel grippers with integrated spring can be used as:

- single-acting grippers
- grippers with supplementary gripping force and
- grippers with gripping force retention

In order to calculate available gripping forces F_{Gr} (per gripper jaw), gripping force (F_H) and spring force (F_F) must be combined accordingly.

Application

The resulting gripping force F_{Gr} , conditional on the application, depends on the gripping action (external/internal gripping) and the gripper design (with/without spring return). The spring force is supplemented in accordance with the design and gripping action.

Single-acting

- Gripping with spring force:
 $F_{Gr} = F_F$
- Gripping with pressure force:
 $F_{Gr} = F_H - F_F$

Supplementary gripping force

- Gripping with pressure and spring force:
 $F_{Gr} = F_H + F_F$

Gripping force retention

- Gripping with spring force:
 $F_{Gr} = F_F$

		Pressurised (in gripping action)	Unpressurised
HGPP...-A	Internal gripping	$F_{Gr} = F_H$	$F_{Gr} = 0$
	External gripping	$F_{Gr} = F_H$	$F_{Gr} = 0$
HGPP...-G1	Internal gripping	$F_{Gr} = F_H + F_F$	$F_{Gr} = F_F$
	External gripping	$F_{Gr} = F_H - F_F$	$F_{Gr} = 0$
HGPP...-G2	Internal gripping	$F_{Gr} = F_H - F_F$	$F_{Gr} = 0$
	External gripping	$F_{Gr} = F_H + F_F$	$F_{Gr} = F_F$

Parallel grippers HGPP, precision

Technical data

Gripping force F_H at 6 bar as a function of lever arm x and eccentricity y

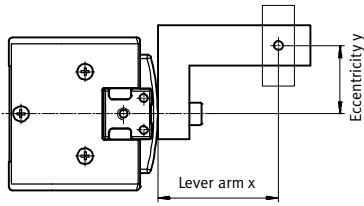

Gripping forces at 6 bar dependent upon eccentric application of force and the maximum permissible off-centre point of force application can be determined for the various sizes using the following graphs.

Calculation example

Given:

Gripper HGPP-12-A

Lever arm $x = 20$ mm

Eccentricity $y = 22$ mm

To be found:

Gripping force at 6 bar

Procedure:

- Determine the intersection xy between lever arm x and eccentricity y in the graph for HGPP-12-A
- Draw an arc (with centre at origin) through intersection xy
- Determine the intersection between the arc and the X axis
- Read gripping force

Result:

Gripping force = approx. 55 N

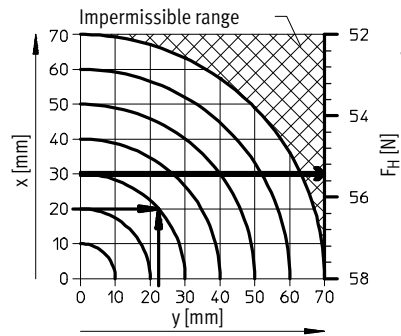

HGPP-10-A

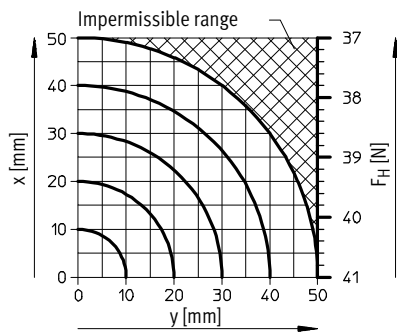

HGPP-12-A

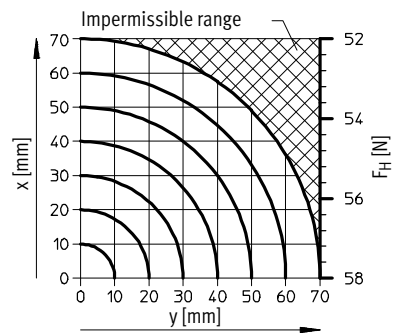

HGPP-16-A

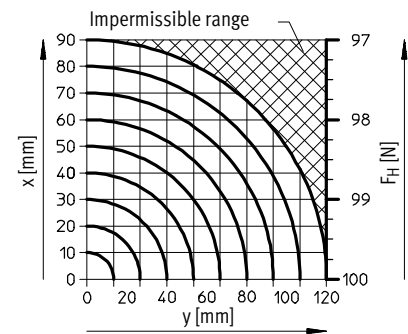

HGPP-20-A

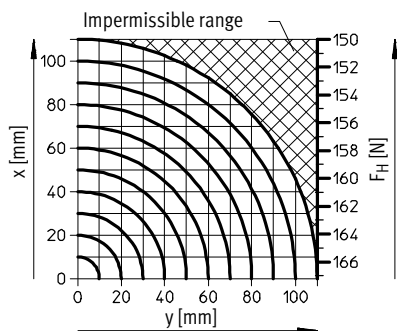

HGPP-25-A

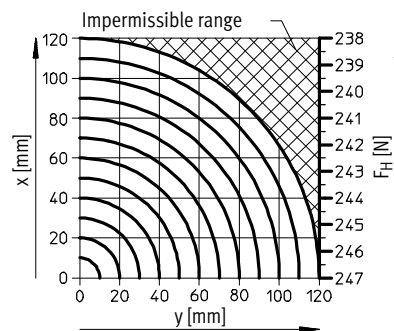

HGPP-32-A

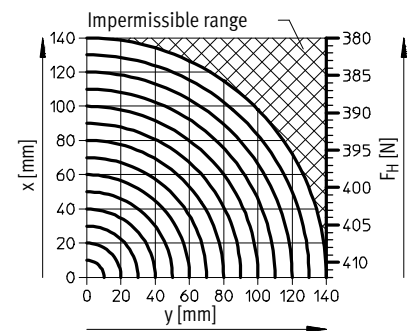

Parallel grippers HGPP, precision

Technical data

FESTO

Dimensions

Download CAD data → www.festo.com

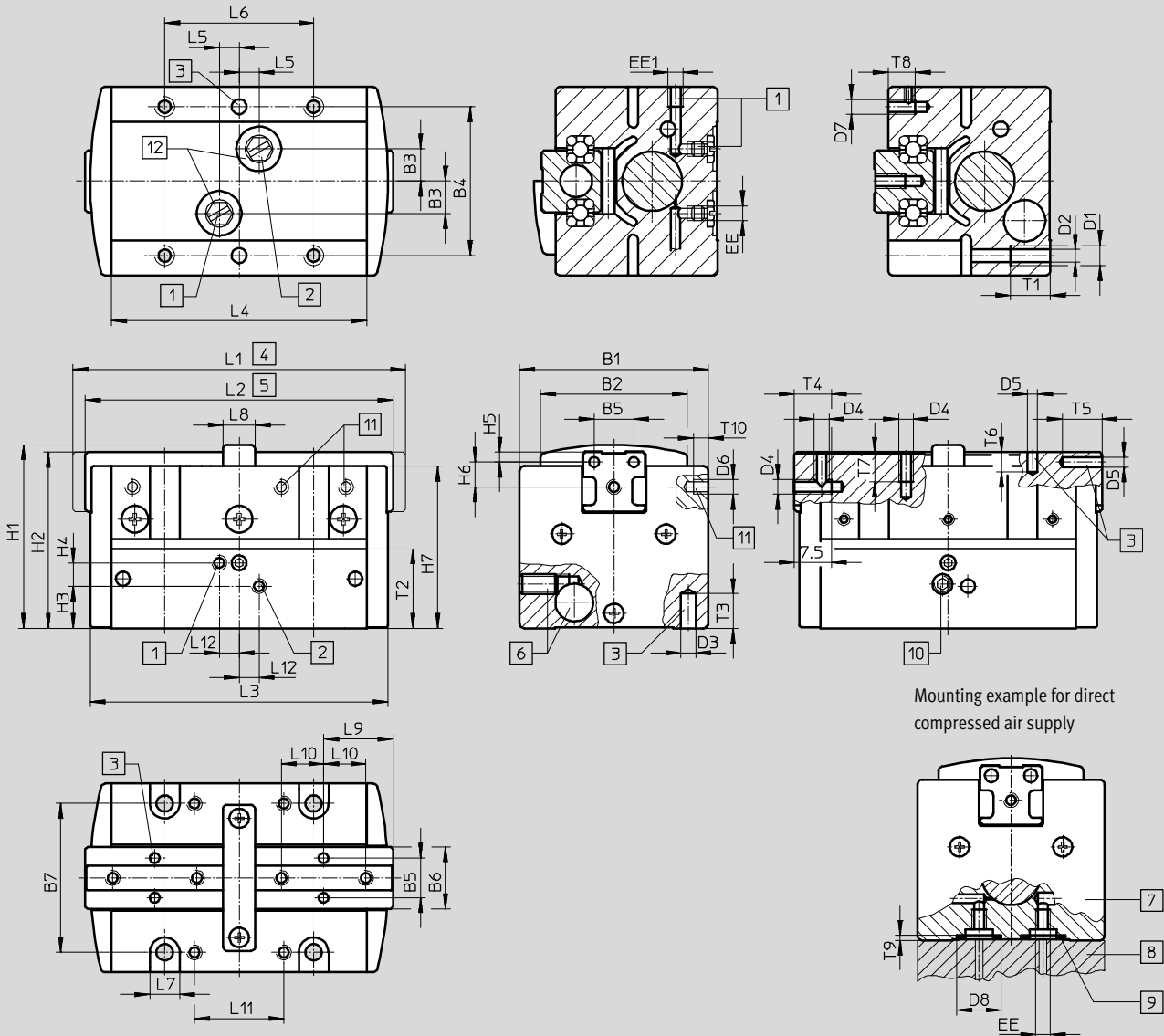

Mounting example for direct compressed air supply

- | | | | |
|---|--|--|--|
| <p>1 Compressed air connection, opening</p> | <p>5 Gripper jaws closed</p> | <p>9 O-ring for parallel grippers:
HGPP-10: \varnothing 5.5x1.5
HGPP-12: \varnothing 5.5x1.5</p> | <p>10 Set screw for mounting position sensor SMH-S1</p> |
| <p>2 Compressed air connection, closing</p> | <p>6 Hole for sensor kit</p> | <p>HGPP-16: \varnothing 8.13x1.78
HGPP-20: \varnothing 8.13x1.78</p> | <p>11 Thread for securing the mounting bracket HGPP-HWS-Q5</p> |
| <p>3 Hole for locating pin
(Locating pins are not included in scope of delivery.)</p> | <p>7 Parallel gripper</p> | <p>HGPP-25: \varnothing 8.13x1.78
HGPP-32: \varnothing 8.13x1.78
(Not included in scope of delivery)</p> | <p>12 Supply ports on base sealed on delivery</p> |
| <p>4 Gripper jaws open</p> | <p>8 Adapter (e. g. customer-specific)</p> | | |

Parallel grippers HGPP, precision

FESTO

Technical data

Size	B1	B2	B3	B4 ±0.02 ¹⁾ ±0.1 ²⁾	B5	B6	B7	D1	D2 ∅
[mm]	+0.3	±0.1	±0.05		±0.02	±0.1	±0.1		+0.1
10	33	26	6.5	27	8	12.5	27	M4	3.3
12	38	29.5	6.5	30	8	12.5	30	M4	3.3
16	42	30.5	8.5	32	10	16	32	M4	3.3
20	48	36.5	10	40	12	20	40	M5	4.2
25	55	42	12	45	15	25	45	M6	5.1
32	62	45	14	52	18	30	52	M6	5.1

Size	D3 ∅	D4	D5 ∅	D6	D7	D8 ∅	EE	EE1	H1
[mm]	H8		H8			H11			
10	3	M3	2	M2	M3	9	M3	M3	32.7 ±0.15
12	3	M3	2	M2	M3	9	M3	M3	37 +0.3/-0.1
16	3	M3	2.5	M2	M3	12.1	M5	M5	42.5 +0.4/-0.1
20	3	M4	3	M2	M3	12.1	M5	M5	55.5 +0.4/-0.1
25	5	M5	4	M2	M3	12.1	M5	M5	57.5 ±0.15
32	5	M6	5	M2	M4	12.1	M5	G ¹ / ₈	68.6 ±0.15

Size	H2	H3	H4	H5	H6	H7	L1	L2	L3	L4
[mm]	±0.1		±0.1	±0.02	±0.12	-0.3	±0.5	±0.5	±0.25	±0.05
10	31.4	8.9 ±0.25	3.7	2	2.6	28.7	62	58	56	47.4
12	35.5	8.5 ±0.3	4.7	2	5	32.7	67	62	60	51.4
16	40.9	8.3 ±0.2	6.8	3	5	37.1	98	88	86	76
20	53.48	15.5 ±0.2	8	3	7	48.5	120	105	103	92
25	56	12.5 ±0.25	7.5	4	8	51	163	143	139.4	127.4
32	67	12.5 ±0.25	11	5	9	60.5	197.4	172.4	169.4	155.4

Size	L5	L6	L7	L8	L9	L10	L11	L12	T1
[mm]	±0.05	±0.1		±0.1	±0.02	±0.05	±0.1	±0.05	
10	5	27	6	6	13.5	7.5	15	4	8
12	4	30	6	6.5	14	8.5	18	4	8
16	6.5	40	6	12	17.5	11.5	24	6.5	10
20	7.5	40	8	18	21	13.5	26	7.5	12
25	12	45	9	22	29.8	17	28	12	12
32	15	52	9	27	33.5	20	35	15	12

Size	T2	T3	T4	T5	T6	T7	T8	T9	T10
[mm]								+0.1	
10	14.85	6	8	5	4	6	3.8	1	3
12	16	6	7.5	5	4	6	5.5	1	3
16	19.5	7	8	6	4.5	6	5	1.3	4
20	28.5	7	10	8	7	8	6	1.3	7
25	27	10	10	8	8	10	6	1.3	8
32	34.5	10	10	10	10	10	8	1.3	8

1) For locating hole

2) For thread and through-holes



-||- Note: This product conforms to ISO 1179-1 and to ISO 228-1

Parallel grippers HGPP, precision

Ordering data and accessories

Ordering data					
Size [mm]	Double-acting Without compression spring		Single-acting or with gripping force retention		
	Part No.	Type	Opening Part No. Type		Closing Part No. Type
10	525 658	HGPP-10-A	525 659	HGPP-10-A-G1	525 660 HGPP-10-A-G2
12	187 867	HGPP-12-A	187 868	HGPP-12-A-G1	187 869 HGPP-12-A-G2
16	187 870	HGPP-16-A	187 871	HGPP-16-A-G1	187 872 HGPP-16-A-G2
20	187 873	HGPP-20-A	187 874	HGPP-20-A-G1	187 875 HGPP-20-A-G2
25	525 661	HGPP-25-A	525 662	HGPP-25-A-G1	525 663 HGPP-25-A-G2
32	525 664	HGPP-32-A	525 665	HGPP-32-A-G1	525 666 HGPP-32-A-G2

Ordering data – Wearing parts kits		
Size [mm]	Part No.	Type
10	673 172	HGPP-10
12	673 173	HGPP-12
16	673 174	HGPP-16
20	673 175	HGPP-20
25	673 176	HGPP-25
32	673 177	HGPP-32

Ordering data – Accessories				
	Size [mm]	Weight [g]	Part No.	Type
Position sensor SMH-S1 Technical data → Internet: smh-s1				
	10, 12	20	189 040	SMH-S1-HGPP10/12
	16	20	189 041	SMH-S1-HGPP16
	20, 25	20	189 042	SMH-S1-HGPP20/25
	32	20	526 895	SMH-S1-HGPP32
Evaluation unit SMH-AE1 Technical data → Internet: smh-ae1				
	10 ... 32	170	175 708	SMH-AE1-PS3-M12
		170	175 709	SMH-AE1-NS3-M12
Proximity sensor SIES-Q5B Technical data → Internet: sies				
	10 ... 32	22	178 291	SIES-Q5B-PS-K-L
		22	174 549	SIES-Q5B-PO-K-L
		22	178 290	SIES-Q5B-NS-K-L
		22	174 548	SIES-Q5B-NO-K-L

Parallel grippers HGPP, precision

Accessories

FESTO

Dimensions – Mounting bracket

Download CAD data → www.festo.com

HGPP-HWS-Q5

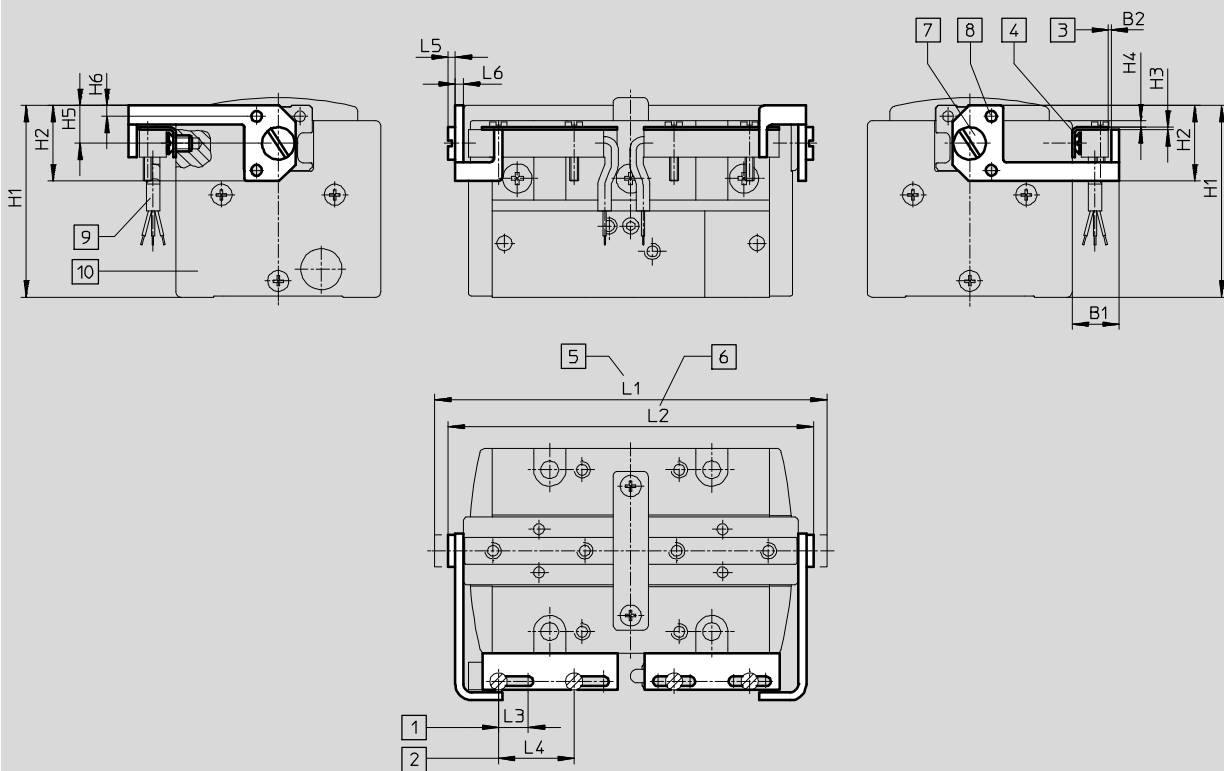

- | | | | |
|---|--|---|----------------------------------|
| 1 Adjusting range for position sensing | 3 Switching distance | 7 Fixing screw for mounting bracket | 10 Parallel grippers HGPP |
| 2 Mounting space for proximity sensor SIES-Q5B | 4 Mounting for sensor bracket | 8 Locating pin | |
| | 5 Gripper jaws position, open | 9 Proximity sensor SIES-Q5B (to be ordered separately) | |
| | 6 Gripper jaws position, closed | | |

For size	B1	B2	H1	H2	H3	H4	H5	H6
[mm]								
10	8.7	0.5	35.5	14	0.5	1.2	7	2
12	8.7	0.5	35.5	14	0.5	1.2	7	2
16	8.5	0.5	35.4	16	0.5	1.2	8	3
20	8.5	0.5	36	20	0.5	2	10	3
25	9.5	0.55	46.3	24	1	3.7	12	4
32	9.5	0.55	55.5	28	1	4	14	5

For size	L1	L2	L3	L4	L5	L6	Weight	Part No.	Type
[mm]							[g]		
10	67.6	63.6	5.5	14	1.8	1.5	4.2	532 272	HGPP-HWS-Q5-1
12	73.6	68.6	5.5	14	1.8	1.5	5.6	532 273	HGPP-HWS-Q5-2
16	105.6	95.6	8.5	14	1.8	2	8.3	532 274	HGPP-HWS-Q5-3
20	126.8	111.8	8.5	14	2.4	2	11.4	532 275	HGPP-HWS-Q5-4
25	171	151	28	14	3	2	17.6	532 276	HGPP-HWS-Q5-5
32	206.6	181.6	28	14	3.6	2	24.6	532 277	HGPP-HWS-Q5-6

Parallel grippers HGPP, precision



Accessories



Adapter kit
HAPG, HMSV

Material:
Wrought aluminium alloy
Free of copper and PTFE
RoHS-compliant

 Note
The kit includes the individual mounting interface as well as the necessary mounting material.

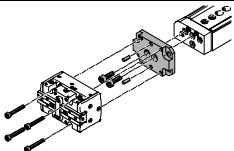
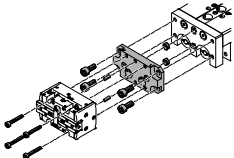
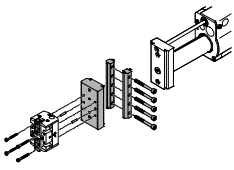
Permissible drive/gripper combinations with adapter kit						Download CAD data → www.festo.com		
Combination	Drive Size	Gripper Size	Mounting option		Adapter kit			
					CRC ¹⁾	Part No.	Type	
DGSL/HGPP	DGSL	HGPP				HAPG		
	8, 10	10	■	■	2	529017	HAPG-57	
	12, 16	10	■	■		529018	HAPG-58	
	12, 16	12	■	■		191266	HAPG-48	
	20, 25	12	■	■		191267	HAPG-49	
	20, 25	16	■	■		191269	HAPG-51	
	20, 25	20	■	■		191270	HAPG-52	
SLT/HGPP	SLT	HGPP				HAPG		
	10	10	■	–	2	529017	HAPG-57	
	16	10	■	–		529018	HAPG-58	
	16	12	■	–		191266	HAPG-48	
	20	12	■	–		191267	HAPG-49	
	20	16	■	–		191268	HAPG-50	
	25	16	■	–		191269	HAPG-51	
	25	20	■	–		191270	HAPG-52	
HMP/HGPP	HMP	HGPP				HAPG, HMSV		
	Direct mounting					2		
	16	12	–	■	191262		HAPG-44	
	16	16	–	■	191263		HAPG-45	
	20, 25, 32	16	–	■	191264		HAPG-46	
	25, 32	20	–	■	191265		HAPG-47	
	25, 32	25	–	■	529019		HAPG-59	
	32	32	–	■	529020	HAPG-61		
	Dovetail mounting					2		
	16	12	–	■	191262		HAPG-44	
			–	■	177649		HMSV-3	
	16	16	–	■	191263		HAPG-45	
			–	■	177649		HMSV-3	
	20, 25	16	–	■	191264		HAPG-46	
			–	■	177653		HMSV-7	
	25	20	–	■	191265		HAPG-47	
			–	■	177653		HMSV-7	
	25, 32	25	–	■	529019		HAPG-59	
			–	■	177653		HMSV-7	
	32	32	–	■	529020		HAPG-61	
–			■	177653	HMSV-7			

1) Corrosion resistance class 2 according to Festo standard 940 070
Components subject to moderate corrosion stress. Externally visible parts with primarily decorative surface requirements which are in direct contact with a normal industrial environment or media such as coolants or lubricating agents.

Parallel grippers HGPP, precision



Accessories

FESTO

Adapter kit
HAPG, HMSV, HMVA

Material:
Wrought aluminium alloy
Free of copper and PTFE
RoHS-compliant

 Note
The kit includes the individual mounting interface as well as the necessary mounting material.

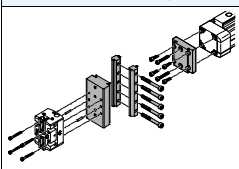
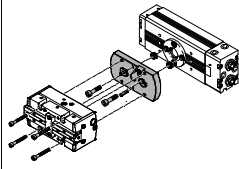
Permissible drive/gripper combinations with adapter kit					Download CAD data → www.festo.com			
Combination	Drive Size	Gripper Size	Mounting option		Adapter kit			
					CRC ¹⁾	Part No.	Type	
DGP..., DGE-..., DGEA/HGPP	DG...	HGPP				HAPG, HMSV, HMVA		
	18 ²⁾ , 25 ³⁾	12	■	■	2	196788	HMVA-DLA18/25	
						191262	HAPG-44	
						177649	HMSV-3	
	18 ²⁾ , 25 ³⁾	16	■	■		196788	HMVA-DLA18/25	
						191263	HAPG-45	
						177649	HMSV-3	
	40 ³⁾	16	■	■	196790	HMVA-DLA40		
					191264	HAPG-46		
					177653	HMSV-7		
	40 ³⁾	20	■	■	196790	HMVA-DLA40		
					191265	HAPG-47		
					177653	HMSV-7		
	40 ³⁾	25	■	■	196790	HMVA-DLA40		
					529019	HAPG-59		
					177653	HMSV-7		
	40 ³⁾	32	■	■	196790	HMVA-DLA40		
					529020	HAPG-61		
					177653	HMSV-7		
DRQD/HGPP	DRQD	HGPP				HAPG		
	DRQD-...-FW					2		
	16 ⁴⁾ , 20 ⁴⁾	10	■	■	526023		HAPG-SD2-17	
	16 ⁴⁾ , 20 ⁴⁾	12	■	■	191255		HAPG-SD2-14	
	20 ⁴⁾ , 25 ⁵⁾	16	■	■	191256		HAPG-SD2-15	
	25 ⁵⁾ , 32 ⁵⁾	20	■	■	191257		HAPG-SD2-16	
	32 ⁵⁾ , 40, 50	25	■	■	526024		HAPG-SD2-18	
	40, 50	32	■	■	526025	HAPG-SD2-19		
	DRQD-...-ZW					2		
	16	12	■	■	191258		HAPG-40	
	20	12	■	■	191259		HAPG-41	
	25	16	■	■	191260		HAPG-42	
		32	20	■	■	191261	HAPG-43	

- 1) Corrosion resistance class 2 according to Festo standard 940 070
Components subject to moderate corrosion stress. Externally visible parts with primarily decorative surface requirements which are in direct contact with a normal industrial environment or media such as coolants or lubricating agents.
- 2) Only for DGEA-...
- 3) Only for DGE-.../DGP...
- 4) Possible in combination with DRQD-...-E422 (flanged shaft with energy through-feed).
- 5) Possible in combination with DRQD-...-E444 (flanged shaft with energy through-feed).

Parallel grippers HGPP, precision



Accessories



Adapter kit
HAPG, DHAA

Material:
Wrought aluminium alloy
Free of copper and PTFE
RoHS-compliant

 Note
The kit includes the individual mounting interface as well as the necessary mounting material.

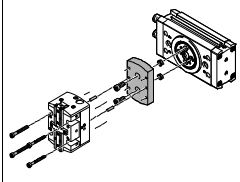
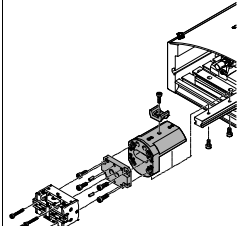
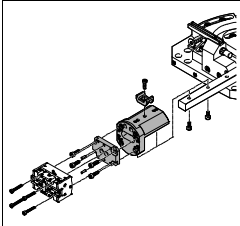
Permissible drive/gripper combinations with adapter kit						Download CAD data → www.festo.com	
Combination	Drive Size	Gripper Size	Mounting option		Adapter kit		
					CRC ¹⁾	Part No. Type	
DRRD/HGPP	DRRD	HGPP			DHAA		
	16	10	■	■	2	2157955	DHAA-G-Q11-16-B5-10
	16	12	■	■		2154048	DHAA-G-Q11-16-B5-12
	20	10	■	■		2158267	DHAA-G-Q11-20-B5-10
	20	12	■	■		2152457	DHAA-G-Q11-20-B5-12
	20	16	■	■		2152074	DHAA-G-Q11-20-B5-16
	25	16	■	■		1722274	DHAA-G-Q11-25-B5-16
	25	20	■	■		1722461	DHAA-G-Q11-25-B5-20
	32	20	■	■		2177999	DHAA-G-Q11-32-B5-20
	32	25	■	■		2180764	DHAA-G-Q11-32-B5-25
	35	25	■	■		2180954	DHAA-G-Q11-35-B5-25
	35, 40	32	■	■		2181855	DHAA-G-Q11-35/40-B5-32
	HSP/HGPP	HSP	HGPP				HAPG
	16	10	■	-	2	529017	HAPG-57
						540882	HAPG-71-B
	25	10	■	-		529017	HAPG-57
						540883	HAPG-72-B
	16	12	■	-		191900	HAPG-54
						540882	HAPG-71-B
25	12	■	-	191900	HAPG-54		
				540883	HAPG-72-B		
25	16	■	-	191901	HAPG-55		
				540883	HAPG-72-B		
HSW/HGPP	HSW	HGPP			HAPG		
	12, 16	10	■	-	2	529017	HAPG-57
						540882	HAPG-71-B
	16	12	■	-		191900	HAPG-54
						540882	HAPG-71-B
16	16	■	-	191901	HAPG-55		
				540882	HAPG-71-B		

1) Corrosion resistance class 2 according to Festo standard 940 070
Components subject to moderate corrosion stress. Externally visible parts with primarily decorative surface requirements which are in direct contact with a normal industrial environment or media such as coolants or lubricating agents.

Parallel grippers HGPP, precision



Accessories

FESTO

Adapter kit
HAPG, HMSV

Material:
Wrought aluminium alloy
Free of copper and PTFE
RoHS-compliant

 Note
The kit includes the individual mounting interface as well as the necessary mounting material.

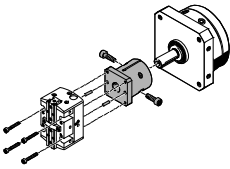
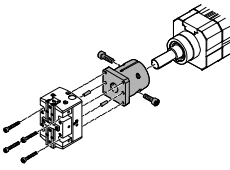
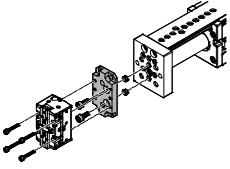
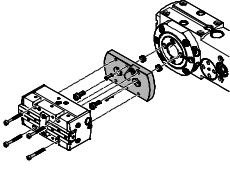
Permissible drive/gripper combinations with adapter kit					Download CAD data → www.festo.com			
Combination	Drive	Gripper	Mounting option		Adapter kit			
					CRC ¹⁾	Part No.	Type	
	DSM	HGPP			HAPG			
	16	12	■	■		2	191258	HAPG-40
	25	12	■	■			191259	HAPG-41
	32	16	■	■			191260	HAPG-42
	40	20	■	■			191261	HAPG-43
	DSL	HGPP			HAPG			
	20	12	■	■		2	191258	HAPG-40
	25	12	■	■			191259	HAPG-41
	32	16	■	■			191260	HAPG-42
	40	20	■	■			191261	HAPG-43
	EGSL	HGPP			HAPG, HMSV			
	35	10	■	■		2	1088262	HMSV-70
	45, 55	10	■	■			529017	HAPG-57
	45, 55	12	■	■			529018	HAPG-58
	75	12	■	■			191266	HAPG-48
	75	16	■	■			191267	HAPG-49
	ERMB	HGPP			HAPG			
	20	10	■	■		2	526023	HAPG-SD2-17
	20	12	■	■			191255	HAPG-SD2-14
	20, 25	16	■	■			191256	HAPG-SD2-15
	25, 32	20	■	■			191257	HAPG-SD2-16
	32	25	■	■			526024	HAPG-SD2-18

1) Corrosion resistance class 2 according to Festo standard 940 070
Components subject to moderate corrosion stress. Externally visible parts with primarily decorative surface requirements which are in direct contact with a normal industrial environment or media such as coolants or lubricating agents.

Parallel grippers HGPP, precision



Accessories



**Adapter kit
HAPG**

Material:
Wrought aluminium alloy
Free of copper and PTFE
RoHS-compliant

 Note
The kit includes the individual mounting interface as well as the necessary mounting material.

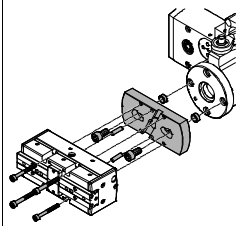
Permissible drive/gripper combinations with adapter kit						Download CAD data → www.festo.com	
Combination	Drive Size	Gripper Size	Mounting option		Adapter kit		
					CRC ¹⁾	Part No.	Type
	EHMB	HGPP			HAPG		
	20	20	■	■	2	191257	HAPG-SD2-16
	20, 25, 32	25	■	■		526024	HAPG-SD2-18
	25, 32	32	■	■		526025	HAPG-SD2-19

1) Corrosion resistance class 2 according to Festo standard 940 070
Components subject to moderate corrosion stress. Externally visible parts with primarily decorative surface requirements which are in direct contact with a normal industrial environment or media such as coolants or lubricating agents.