

Parallel grippers HGPD, sealed

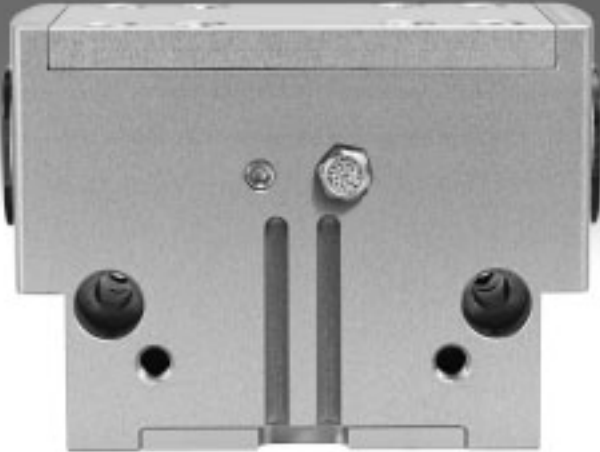

Parallel grippers HGPD, sealed

Key features

At a glance

General information

The fully encapsulated gripper kinematics enable the gripper to be used in extremely harsh ambient conditions.

Sturdy and precise kinematics for maximum torque resistance and long service life.

The force generated by the linear motion is translated into the gripper jaw movement via a wedge mechanism

with forced motion sequence. This also guarantees synchronous movement of the gripper jaw. The ground gripper jaws and slideway ensure a virtually backlash-free movement.

Flexible range of applications

- Can be used as a double-acting and single-acting gripper
- Compression spring for supplementary or retaining gripping forces
- Suitable for external and internal gripping

The technology in detail

Gripper closed

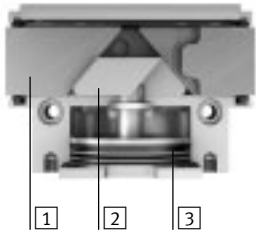

Gripper open



- 1 Gripper jaw
- 2 Wedge with forced guidance
- 3 Piston with magnet

- Note

Gripper selection
sizing software

→ www.festo.com

Wide range of supply ports

Direct

From the front

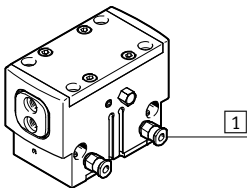

Via adapter plate

From underneath

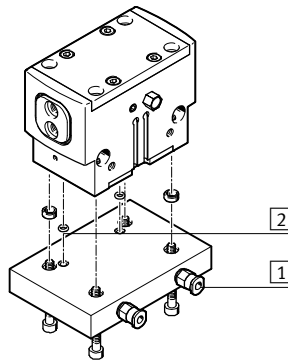

- 1 Supply ports
- 2 O-rings

Other ports

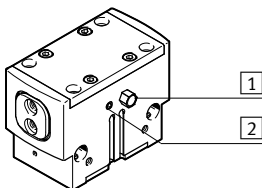

- 1 Exhaust hole or sealing air port
- 2 Port for lubrication nipple

Use in harsh ambient conditions

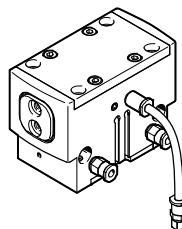

When using the gripper in damp environments or with liquid/gaseous media, make sure that the filter is installed in a neutral environment. The same applies to unused supply ports when operating the gripper as a single-acting gripper.

Parallel grippers HGPS, sealed

Key features

Mounting options

Direct mounting
From above

Via adapter plate
From underneath

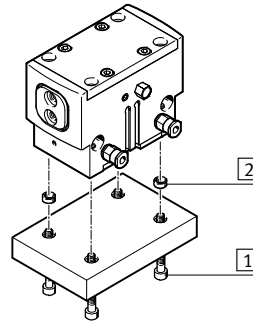
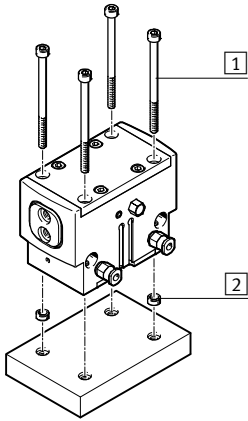

- 1 Mounting screws
- 2 Centring sleeves

Note

These grippers are not suitable or are of limited suitability for the following sample applications:

Not suitable for:

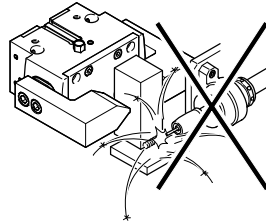

- Welding spatter

Of limited suitability for:

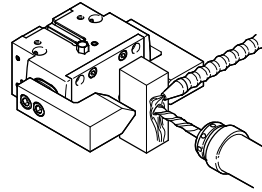

- Aggressive media only possible after consultation with Festo

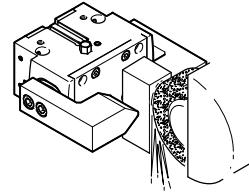

- Grinding dust

Parallel grippers HGPL, sealed

Type codes and peripherals overview

Type codes

		HGPL	-	16	-	A	-	
Type								
HGPL	Parallel gripper							
Size								
Position sensing								
A	Via proximity sensor							
Gripping force retention								
G1	Opening							
G2	Closing							

Peripherals overview

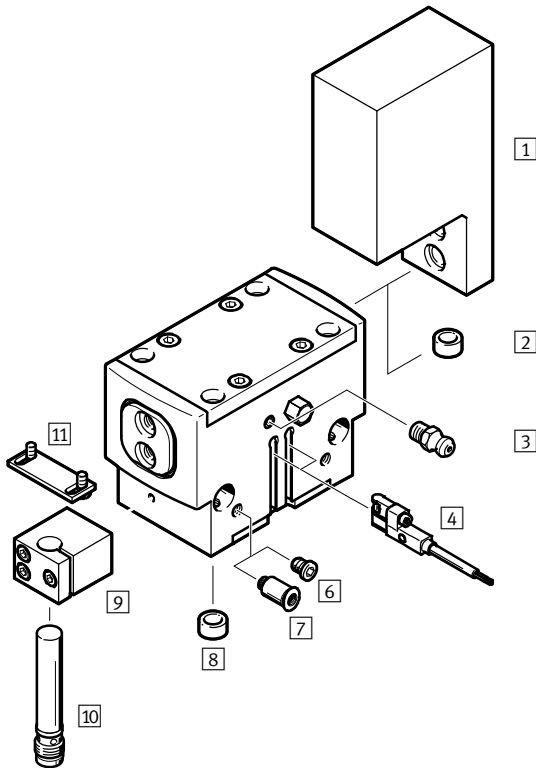

System product for handling and assembly technology

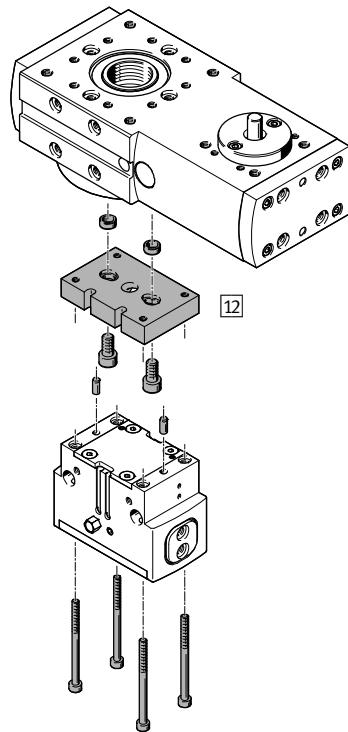

Proportional pressure regulator VPPM

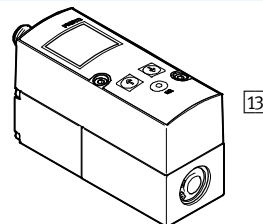

Parallel grippers HGPL, sealed

Peripherals overview

Accessories			
	Type	Brief description	→ Page/Internet
1	Gripper jaw blank BUB-HGPL	Blank specially matched to the gripper jaws for custom fabrication of gripper fingers	20
2	Centring pin/sleeve ZBS/ZBH	<ul style="list-style-type: none"> • For centring gripper jaw blanks/gripper fingers on the gripper jaws • 4 centring pins/sleeves included in the scope of delivery of the gripper 	21
3	Lubrication nipple	Included in the scope of delivery of the gripper	–
4	Proximity sensor SMT-8G/SMT-10G	<ul style="list-style-type: none"> • For sensing the piston position • Proximity sensor does not project past the housing at the bottom 	22
6	Blanking plug B	For sealing the supply ports when using the lower supply ports	21
7	Push-in fitting QS	For connecting compressed air tubing with standard O.D.	quick star
8	Centring sleeve ZBH	For centring the gripper when mounting	21
9	Sensor bracket DASI	Clamping block for securing the proximity sensors SIEH or SIEN	21
10	Proximity sensor SIEH/SIEN	For sensing the piston position	22
11	Sensor bracket DASI	Switch lug for sensing the gripper jaw position. Mounted on the gripper jaw blank	21
12	Adapter kit DHAA	Connecting plate between drive and gripper	17
13	Proportional pressure regulator VPPM	For infinite adjustment of the gripping force	vppm

Parallel grippers HGPD, sealed

Technical data

FESTO

Function
Double-acting
HGPD-...-A

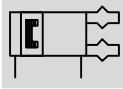

Size
16 ... 80 mm

Total stroke
6 ... 40 mm

www.festo.com

Function – Variants
Single-acting or
with gripping force retention ...
... opening HGPD-...-G1



... closing HGPD-...-G2



General technical data									
Size	16	20	25	35	40	50	63	80	
Design	Wedge-shaped actuator Forced motion sequence								
Mode of operation	Double-acting								
Gripper function	Parallel								
Number of gripper jaws	2								
Max. load per external gripper finger ¹⁾ [g]	25	57	138	278	445	813	1,340	2,170	
Stroke per gripper jaw [mm]	3	4	6	8	10	12	16	20	
Pneumatic connection	M5	M5	M5	M5	M5	G $\frac{1}{8}$	G $\frac{1}{8}$	G $\frac{1}{4}$	
Pneumatic connection for sealing air	M3	M3	M5	M5	M5	M5	M5	M5	
Pneumatic connection for lubrication nipple	M3	M3	M5	M5	M5	M5	M5	M5	
Repetition accuracy ²⁾ [mm]	$\leq \pm 0.03$	$\leq \pm 0.04$		$\leq \pm 0.05$					
Max. interchangeability [mm]	$\leq \pm 0.2$								
Max. operating frequency [Hz]	≤ 1				≤ 2				
Rotational symmetry [mm]	$< \varnothing 0.2$								
Position sensing	Via proximity sensor, position transmitter								
Type of mounting	Via through-hole and dowel pin/centring sleeve Via female thread and dowel pin/centring sleeve								
Mounting position	Any								

1) Valid for unthrottled operation

2) End-position drift under constant conditions of use with 100 consecutive strokes in the direction of movement of the gripper jaws

Operating and environmental conditions		
Min. operating pressure		
HGPD-...-A [bar]		3
HGPD-...-A-G [bar]		4
Max. operating pressure [bar]		8
Operating pressure for sealing air [bar]		0 ... 0.5
Operating medium	Compressed air in accordance with ISO 8573-1:2010 [7:4:4]	
Note on operating/pilot medium	Operation with lubricated medium possible (in which case lubricated operation will always be required)	
Ambient temperature ¹⁾ [°C]		+5 ... +60
Corrosion resistance class CRC ²⁾		2

1) Note operating range of proximity sensors

2) Corrosion resistance class 2 according to Festo standard 940 070

Components subject to moderate corrosion stress. Externally visible parts with primarily decorative surface requirements which are in direct contact with a normal industrial environment or media such as coolants or lubricating agents.

Parallel grippers HGPD, sealed

Technical data

Weight [g]								
Size	16	20	25	35	40	50	63	80
HGPD-...-A	100	163	327	572	1,044	1,766	3,365	6,252
HGPD-...-A-G	117	182	361	682	1,223	2,150	3,998	7,484

Materials

Sectional view

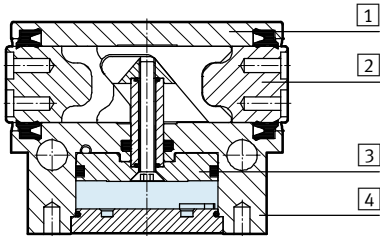

Size	16	20	25	35	40	50	63	80
1 Cover cap	High-alloy stainless steel							
2 Gripper jaw	Hardened steel							
3 Piston	Hard anodised aluminium							
4 Housing	Anodised aluminium							
- Seals	Nitrile rubber							
- Note on materials	Free of copper and PTFE		-					
	RoHS-compliant							

Gripping force [N] at 6 bar

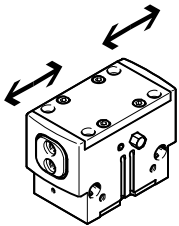

Size	16	20	25	35	40	50	63	80	
Gripping force per gripper jaw									
HGPD-...-A	Opening	54	80	144	291	315	472	967	1,961
	Closing	47	75	133	267	267	447	928	1,858
Total gripping force									
HGPD-...-A	Opening	107	159	288	581	630	944	1,935	3,922
	Closing	94	150	266	534	598	894	1,856	3,716

Parallel grippers HGPD, sealed

Technical data

Characteristic load values at the gripper jaws

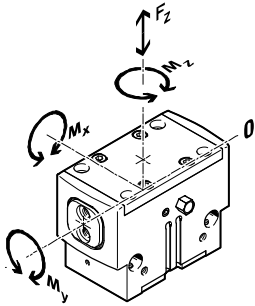

The indicated permissible forces and torques apply to a single gripper jaw. They include the lever arm, additional applied loads due to the workpiece or external gripper fingers and

acceleration forces occurring during movement.

The zero coordinate line (gripper jaw guide) must be taken into consideration for the calculation of torques.

Size		16	20	25	35	40	50	63	80
Max. permissible force F_z	[N]	150	250	500	750	1,200	2,000	3,000	6,000
Max. permissible torque M_x	[Nm]	8	12	30	40	70	90	120	170
Max. permissible torque M_y	[Nm]	4	7	25	30	45	60	80	130
Max. permissible torque M_z	[Nm]	3	6	15	25	35	50	65	110

Mass moment of inertia [kgcm²]

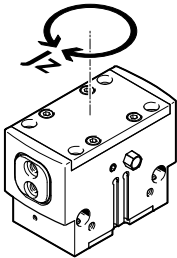

Mass moment of inertia of the parallel gripper in relation to the central axis, without external gripper fingers, without load.

Size		16	20	25	35	40	50	63	80
HGPD-...-A		0.22	0.40	1.32	3.56	10.10	26.19	80.33	236.48
HGPD-...-A-G		0.27	0.52	1.72	4.88	14.09	36.74	116.19	319.95

Gripper jaw backlash

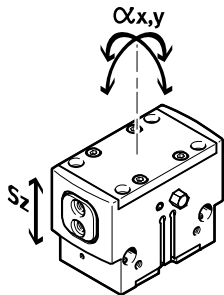

The plain-bearing guide used in the grippers means that there is backlash between the gripper jaws and the housing. The values entered in the table for the backlash were calculated in accordance with the traditional accumulative tolerance method.

Size		16	20	25	35	40	50	63	80
Max. gripper jaw backlash S_z	[mm]	0.02							
Max. gripper jaw angular backlash α_x, α_y	[°]	0.1							

Parallel grippers HGPD, sealed

Technical data

Opening and closing times [ms] at 6 bar

Without external gripper fingers

With external gripper fingers

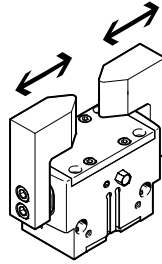
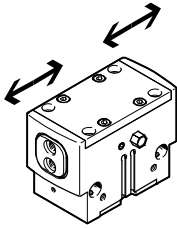

The indicated opening and closing times [ms] were measured at room temperature at an operating pressure of 6 bar with horizontally mounted grippers without additional gripper

fingers. The grippers must be throttled for greater loads [g]. Opening and closing times must then be adjusted accordingly.

Size		16	20	25	35	40	50	63	80
Without external gripper fingers									
HGPD-...-A	Opening	15	28	29	33	73	90	150	214
	Closing	17	31	35	37	77	100	162	218
HGPD-...-A-G1	Opening	15	13	24	31	73	85	170	235
	Closing	32	25	51	62	157	176	328	353
HGPD-...-A-G2	Opening	30	35	48	50	143	170	294	379
	Closing	15	18	28	36	71	87	185	240
With external gripper fingers (as a function of the load)									
HGPD-...	50 g	20	-	-	-	-	-	-	-
	100 g	28	26	-	-	-	-	-	-
	200 g	40	37	30	-	-	-	-	-
	300 g	-	46	37	34	-	-	-	-
	400 g	-	-	43	40	46	-	-	-
	500 g	-	-	-	55	52	-	-	-
	600 g	-	-	-	-	57	-	-	-
	800 g	-	-	-	-	66	125	-	-
	1,000 g	-	-	-	-	-	133	-	-
	1,200 g	-	-	-	-	-	140	-	-
	1,500 g	-	-	-	-	-	-	183	-
	1,800 g	-	-	-	-	-	-	201	-
	2,000 g	-	-	-	-	-	-	211	259
	2,200 g	-	-	-	-	-	-	-	272
	2,400 g	-	-	-	-	-	-	-	284

Parallel grippers HGPD, sealed

Technical data

Gripping force F_H per gripper jaw as a function of operating pressure and lever arm x

The gripping forces as a function of operating pressure and lever arm can be determined from the following graphs.

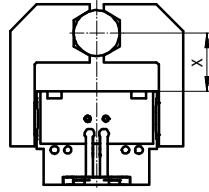

- 3 bar
- - - 6 bar
- · - 8 bar

Note
Gripper selection
sizing software
→ www.festo.com

External gripping (closing)

HGPD-16-A

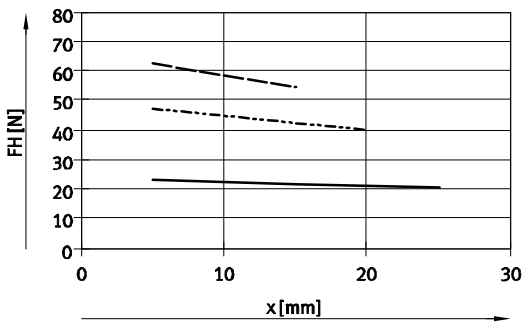

HGPD-20-A

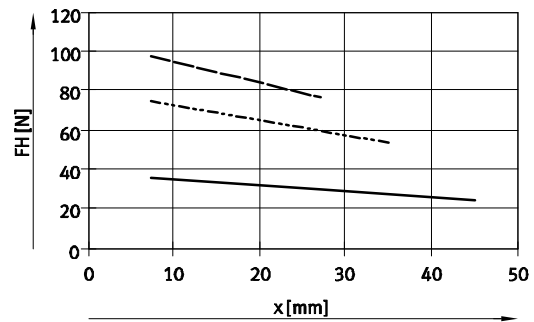

HGPD-25-A

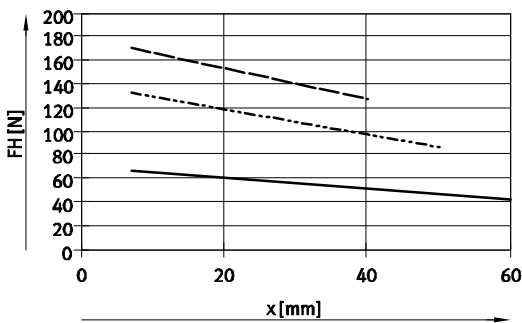

HGPD-35-A

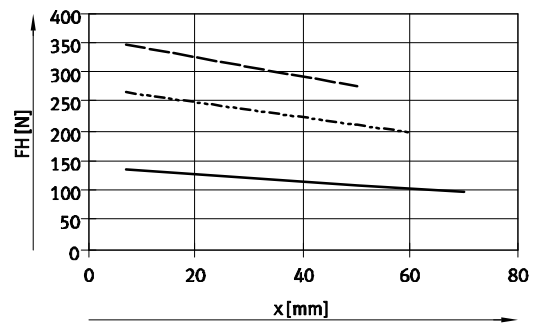

HGPD-40-A

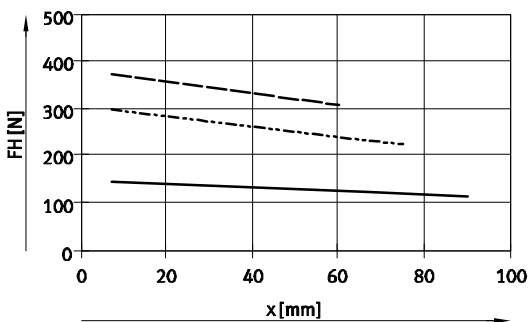

HGPD-50-A

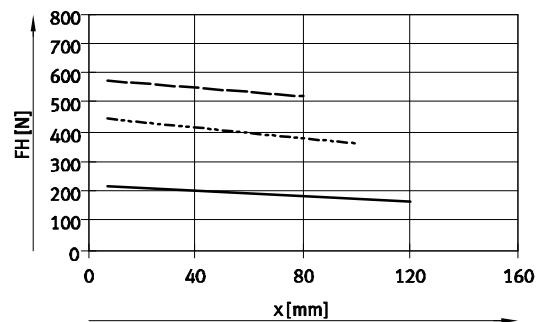

HGPD-63-A

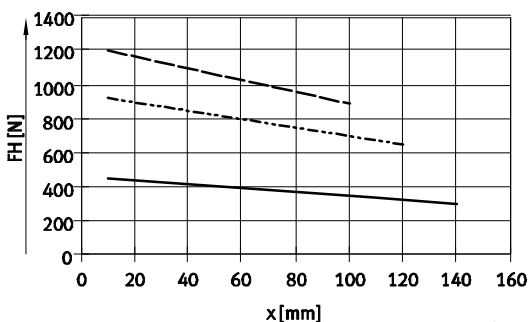

HGPD-80-A

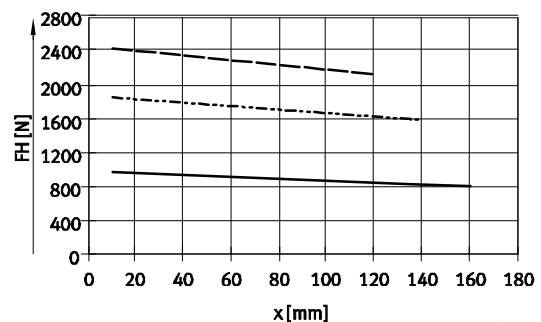

Parallel grippers HGPD, sealed

Technical data

Gripping force F_H per gripper jaw as a function of operating pressure and lever arm x

The gripping forces as a function of operating pressure and lever arm can be determined from the following graphs.

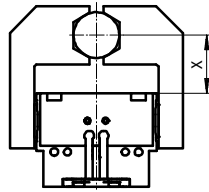

- 3 bar
- · - 6 bar
- - - 8 bar

Note
Gripper selection
sizing software
→ www.festo.com

Internal gripping (opening)

HGPD-16-A

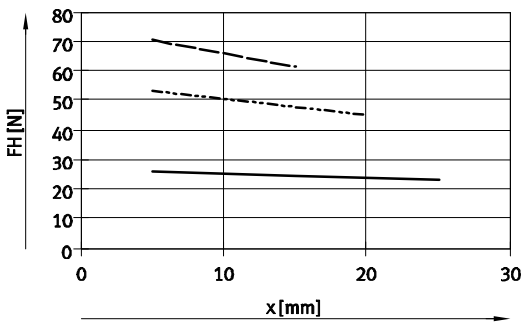

HGPD-20-A

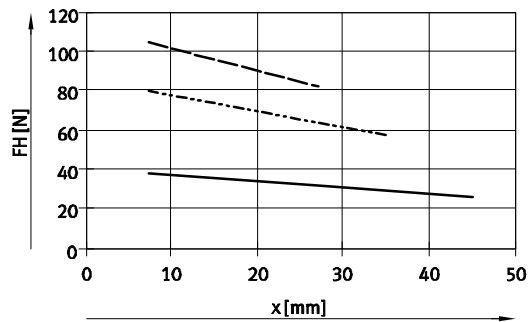

HGPD-25-A

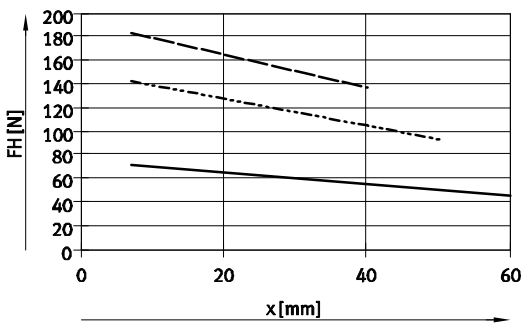

HGPD-35-A

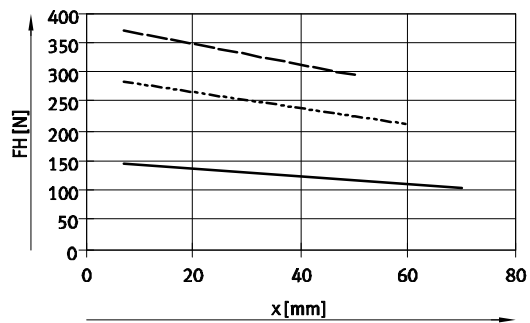

HGPD-40-A

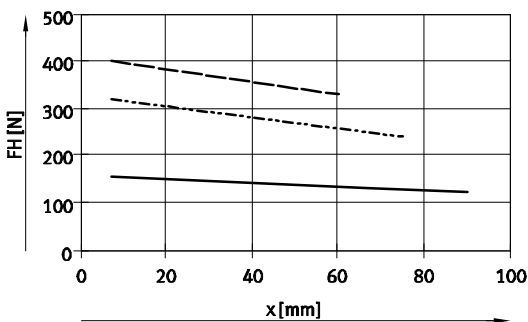

HGPD-50-A

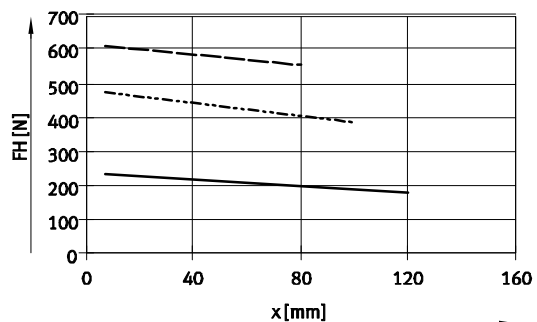

HGPD-63-A

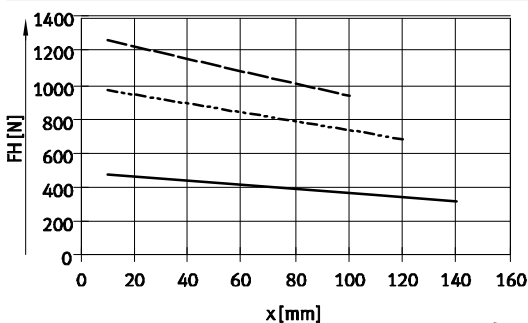

HGPD-80-A

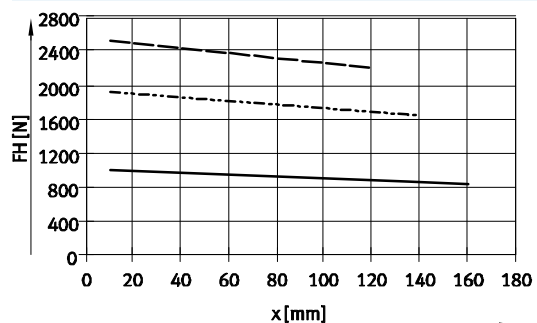

Parallel grippers HGPD, sealed

Technical data

Gripping force F_H per gripper jaw at 6 bar as a function of lever arm x and eccentricity a and b

The following formula must be used to calculate the lever arm x with eccentric gripping:

$$x = \sqrt{a^2 + b^2}$$

The gripping force F_H can be read from the graphs (→ 10) using the calculated value x .

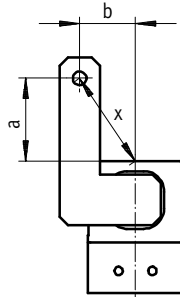

Calculation example

Given:

Distance $a = 45$ mm

Distance $b = 40$ mm

To be calculated:

The gripping force at 6 bar, with an HGPD-40, used as an external gripper

Procedure:

Calculating the lever arm x

$$x = \sqrt{45^2 + 40^2}$$

$$x = 60$$
 mm

The graph (→ 10) gives a value of $F_H = 240$ N for the gripping force.

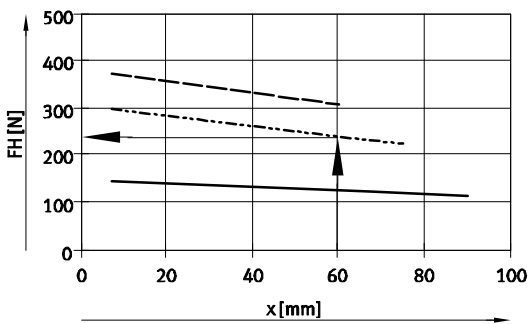

Parallel grippers HGPD, sealed

Technical data

Spring force F_F as a function of size and gripper jaw stroke l

Gripping force retention for HGPD-...-G...

The spring forces F_F as a function of gripper jaw stroke l can be determined from the following graph.

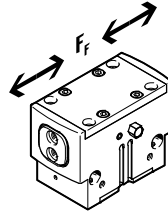

Size 16 ... 35

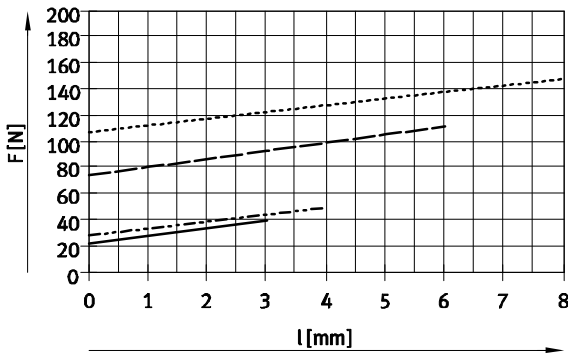

- HGPD-16-A-G
- - - HGPD-20-A-G
- · - HGPD-25-A-G
- · · - HGPD-35-A-G

Size 40 ... 80

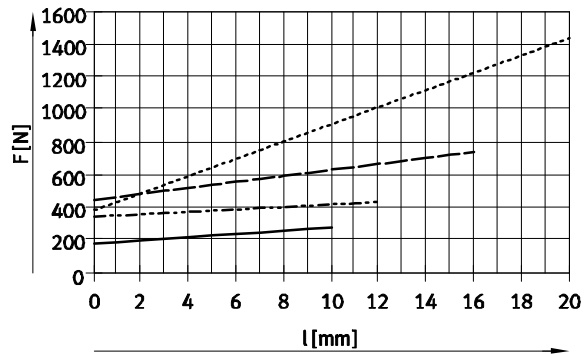

- HGPD-40-A-G
- - - HGPD-50-A-G
- · - HGPD-63-A-G
- · · - HGPD-80-A-G

Spring force F_F as a function of size, gripper jaw stroke l and lever arm x per gripper finger

The lever arm x must be taken into consideration when determining the actual spring force F_{Ftotal} .

The formulae for calculating the spring force are provided in the table below.

Gripping force retention	Size	F_{Ftotal} per gripper finger
G1	16	$-0.25 \cdot x + 0.6 \cdot F_F$
	20	$-0.25 \cdot x + 0.6 \cdot F_F$
	25	$-0.65 \cdot x + 0.6 \cdot F_F$
	35	$-0.75 \cdot x + 0.8 \cdot F_F$
	40	$-0.7 \cdot x + 0.65 \cdot F_F$
	50	$-0.8 \cdot x + 0.5 \cdot F_F$
	63	$-0.8 \cdot x + 0.65 \cdot F_F$
80	$-1.3 \cdot x + 0.6 \cdot F_F$	

Gripping force retention	Size	F_{Ftotal} per gripper finger
G2	16	$-0.05 \cdot x + 0.6 \cdot F_F$
	20	$-0.5 \cdot x + 0.6 \cdot F_F$
	25	$-0.65 \cdot x + 0.6 \cdot F_F$
	35	$-0.15 \cdot x + 0.8 \cdot F_F$
	40	$-0.6 \cdot x + 0.65 \cdot F_F$
	50	$-0.15 \cdot x + 0.5 \cdot F_F$
	63	$-1 \cdot x + 0.65 \cdot F_F$
80	$-0.25 \cdot x + 0.6 \cdot F_F$	

Determination of the actual gripping forces F_{Gr} for HGPD-...-G1 and HGPD-...-G2 as a function of application

The parallel grippers with integrated spring type HGPD-...-G1 (opening gripping force retention) and HGPD-...-G2 (closing gripping force retention) can be used as

- single-acting grippers

- grippers with supplementary gripping force and
- grippers with gripping force retention depending on requirements.

In order to calculate the available gripping forces F_{Gr} (per gripper jaw),

the gripping force (F_H) and spring force (F_{Ftotal}) must be combined accordingly.

Application forces per gripper finger

Single-acting

Supplementary gripping force

Gripping force retention

- Gripping with spring force:
 $F_{Gr} = F_{Ftotal}$
- Gripping with pressure force:
 $F_{Gr} = F_H - F_{Ftotal}$

- Gripping with pressure and spring force:
 $F_{Gr} = F_H + F_{Ftotal}$

- Gripping with spring force:
 $F_{Gr} = F_{Ftotal}$

Parallel grippers HGPD, sealed

Technical data

FESTO

Dimensions

Download CAD data → www.festo.com

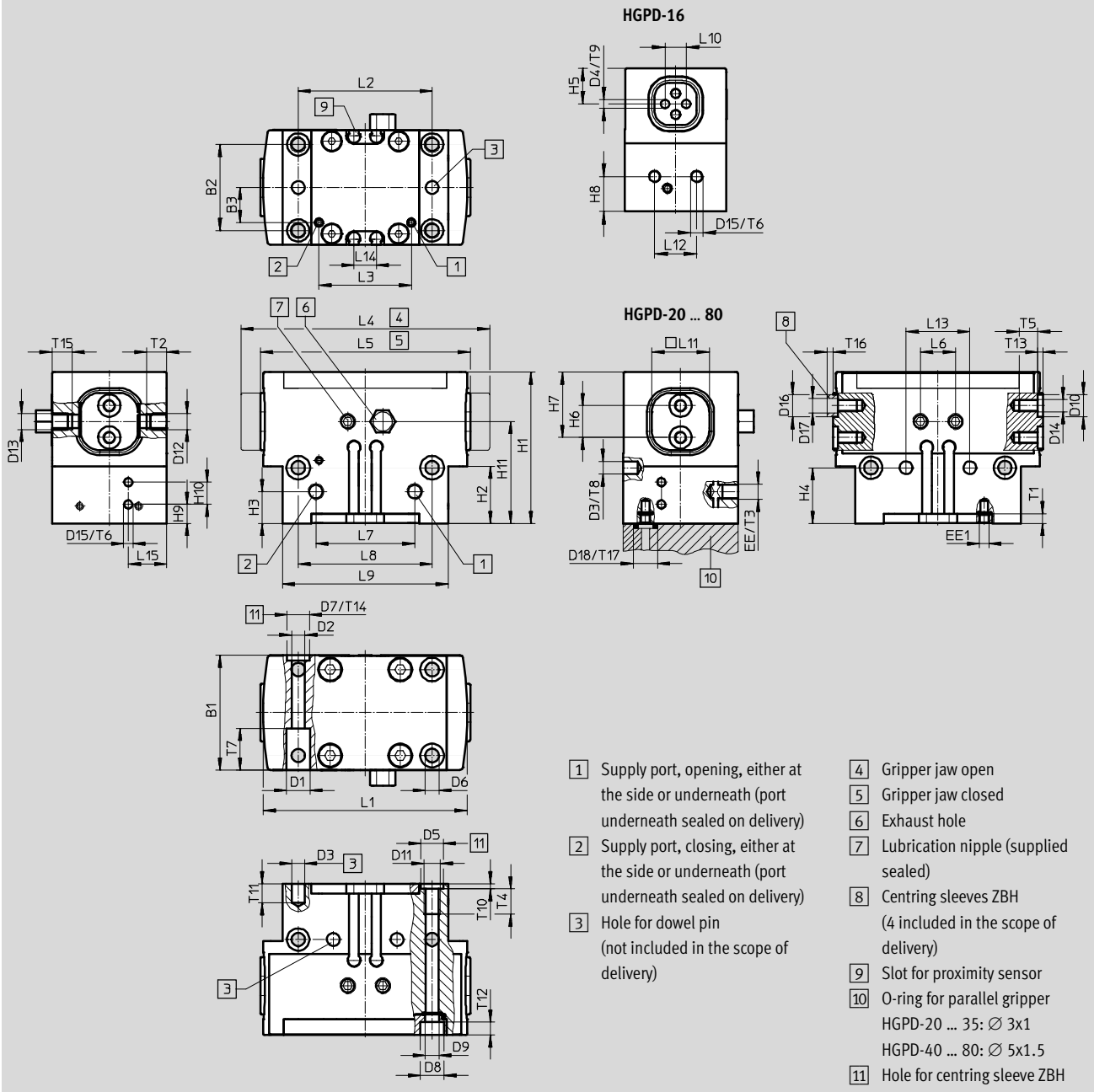

Size	B1	B2 ¹⁾	B3	D1	D2	D3	D4	D5	D6	D7	D8	D9	D10	D11	D12
[mm]	± 0.05		± 0.1	\varnothing H13	\varnothing H8	\varnothing H8	\varnothing H8	\varnothing H8	\varnothing H8	\varnothing H8	\varnothing H13	\varnothing H8	\varnothing H8		
16	24	17	4	4.6	2.6	2	2	5	2.6	–	4.6	–	–	M3	M3
20 ²⁾	28	22	8.7	5.6	3.2	3	–	5	3.2	–	–	–	5	M4	M3
25	36	27	11	7.4	4.2	4	–	7	4.2	7	7.4	4.3	7	M5	M5
35	42	32	13	9.2	5.2	4	–	7	4.2	7	7.4	4.3	9	M5	M5
40	50	38	17	10.4	6.2	5	–	9	5.2	9	9.4	5.3	9	M6	M5
50	60	45	20	13.5	8.2	6	–	12	6.1	12	10.4	6.4	12	M8	M5
63	72	56	24.5	13.5	8.4	6	–	12	6.4	12	10.4	–	12	M8	M5
80	100	70	39.5	18.5	12.2	8	–	12	8.5	15	13.5	8.4	15	M10	M5

1) Tolerance for centring hole ± 0.02 mm
Tolerance for thread ± 0.1 mm

2) Dowel pins 3) must be used when mounted from below.

Parallel grippers HGPD, sealed

Technical data

Size [mm]	D13	D14	D15	D16 ∅ h7	D17 ∅	D18 ∅ +0.2	EE	EE1	H1		H2		H3	
									±0.05	-G ±0.05		-G	±0.1	-G ±0.1
16	M3	M2.5	M3	-	-	-	M5	M3	34	41.5	16.2	23.6	12	12
20	M3	M3	M3	5	3.2	5	M5	M3	39	46	15	22	10	15
25	M5	M4	M3	7	5.3	5	M5	M3	47.5	55.5	18	26	10	20
35	M5	M6	M3	9	6.4	5	M5	M3	57.5	74	21.5	38	12	23.5
40	M5	M6	M3	9	6.4	8	M5	M3	67	85	27	45	15	36
50	M1½	M6	M3	12	10.3	8	G1½	M5	77.5	102.5	32	57	15	30
63	M1½	M8	M3	12	10.3	8	G1½	M5	94	124	39	69	18	26
80	M1½	M10	M3	15	12.4	8	G1¼	M5	110	146	48	84	22	33

Size [mm]	H4 ¹⁾		H5	H6 ¹⁾	H7	H8		H9		H10	H11		L1	L2 ¹⁾	L3
		-G	-0.02		-0.02	±0.1	-G ±0.1	±0.1	-G ±0.1	±0.1	±0.1	±0.1	±0.1	±0.05	
16	17.5	24.5	8.5	5	11	8.3	15.8	-	-	-	25.5	33	50	29	22
20	14.5	21.5	-	7	15	6.5	13.5	-	-	-	27.5	34.5	50	35	22.6
25	17.5	26	-	10	20.5	-	-	6	14	7	32	40	64	42	29
35	20	37.5	-	12	24	-	-	9.5	26	7	39.5	56	80	52	39
40	25	42.5	-	15	28.5	-	-	15	33	8	46	64	101	66	47.4
50	30	55	-	18	32	-	-	15.5	40.5	8	54.5	79.5	126	82	61
63	28	68	-	24	40	-	-	26	56	8	66	96	161	100	75
80	34	76	-	24	42	-	-	35	71	8	80	116	201	130	82

Size [mm]	L4	L5	L6	L7	L8 ¹⁾	L9	L10	L11	L12	L13	L14	L15	T1	T2	T3
	±0.5	±0.5	±0.1	±0.1		±0.1	±0.05	-0.02	±0.1	±0.02	+0.1	±0.1	min.	min.	min.
16	58	52	6.5	20	29	36	5	10	10	20	6	-	3	5.5	5.5
20	60	52	7.5	24	35	44	-	14	10	24	6	-	3	5.5	5.5
25	78	66	11	31	42	52	-	18	-	20	7	12	3	6.7	5.5
35	98	82	11	40	52	64	-	22	-	40	7	15	3	6.5	5.5
40	122	102	11	49	66	81	-	28	-	50	10	19	4	6.5	6.5
50	151	127	11	63	82	101	-	32	-	60	10	24	4	6.5	8.5
63	194	162	11	74	100	126	-	40	-	76	10	42	4	6.5	8.5
80	242	202	11	82	130	154	-	45	-	100	10	56	5.5	6.5	10

Size [mm]	T4		T5	T6	T7	T8	T9	T10	T11	T12	T13	T14	T15	T16	T17
	min.	-G min.	min.	min.		min.	+0.1	+0.1	min.	+0.2	+0.1	+0.1	min.	-0.3	+0.1
16	5.5	-	5	3.5	14	4.5	2.6	1.3	4	19.8	-	-	5.5	-	-
20	6.5	-	5	5	18	4	-	1.3	5	3	1.3	-	5.5	1.2	0.6
25	10.5	-	6	5	13	4.5	-	1.6	6	4.1	1.6	1.6	6.7	1.4	0.6
35	8.5	-	7.9	5	16	4.5	-	1.6	6	4.1	2.1	1.6	6.5	1.9	0.6
40	12.5	-	7.9	5	28	6	-	2.1	7	5.1	2.1	2.1	6.5	1.9	1.1
50	12.5	-	10	5	24	6	-	2.6	8	6.1	2.6	2.6	6.5	2.4	1.1
63	12.5	-	12	5	27	6	-	2.6	8	4.5	2.6	2.6	6.5	2.4	1.1
80	12.4	15	15	5	41	10	-	2.6	10	5.5	3.1	3.1	6.5	2.9	1.1

1) Tolerance for centring hole ±0.02 mm
Tolerance for thread ±0.1 mm

Parallel grippers HGPD, sealed

Technical data

FESTO

Ordering data						
Size [mm]	Double-acting without compression spring		Single-acting or with gripping force retention			
	Part No.	Type	Opening		Closing	
	Part No.	Type	Part No.	Type	Part No.	Type
16	1132936	HGPD-16-A	1132937	HGPD-16-A-G1	1132938	HGPD-16-A-G2
20	1132939	HGPD-20-A	1132940	HGPD-20-A-G1	1132941	HGPD-20-A-G2
25	1132942	HGPD-25-A	1132943	HGPD-25-A-G1	1132944	HGPD-25-A-G2
35	1132945	HGPD-32-A	1132946	HGPD-32-A-G1	1132947	HGPD-32-A-G2
40	1132948	HGPD-40-A	1132949	HGPD-40-A-G1	1132950	HGPD-40-A-G2
50	1132951	HGPD-50-A	1132952	HGPD-50-A-G1	1132953	HGPD-50-A-G2
63	1132954	HGPD-63-A	1132955	HGPD-63-A-G1	1132956	HGPD-63-A-G2
80	1132957	HGPD-80-A	1132958	HGPD-80-A-G1	1132959	HGPD-80-A-G2

Parallel grippers HGPL, sealed



Accessories

FESTO

Adapter kit
DHAA, HAPG

Material:
Wrought aluminium alloy
Free of copper and PTFE
RoHS-compliant

 Note
The kit includes the individual mounting interface as well as the necessary mounting material.

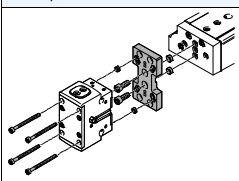
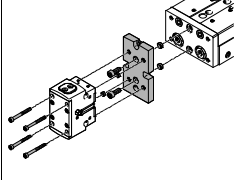
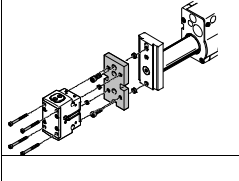
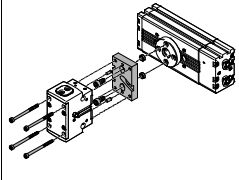
Permissible drive/gripper combinations with adapter kit					Download CAD data → www.festo.com			
Combination	Drive Size	Gripper Size	Mounting option		Adapter kit			
					CRC ¹⁾	Part No.	Type	
	DGSL	HGPL			DHAA, HAPG			
	8, 10	16, 20	■	■	2	564957	DHAA-G-G6-8-B8-16	
	12, 16	16, 20	■	■		564954	DHAA-G-G6-16-B8-16	
	12, 16	25	■	■		564952	DHAA-G-G6-16-B8-25	
	20, 25	25, 35	■	■		537175	HAPG-79	
	20, 25	40	■	■		564951	DHAA-G-G6-20-B8-40	
	SLT	HGPL			DHAA, HAPG			
	6	16	-	■	2	537168	HAPG-74	
	10	16, 20	-	■		564957	DHAA-G-G6-8-B8-16	
	16	16, 20	-	■		564954	DHAA-G-G6-16-B8-16	
	16	25	-	■		564952	DHAA-G-G3-20-B11-25	
	20	25, 35	-	■		537175	HAPG-79	
	25	35	-	■		564953	DHAA-G-H2-20-B8-35	
	25	40	-	■		564951	DHAA-G-G6-20-B8-40	
	HMP	HGPL			DHAA, HAPG			
	16	25	-	■	2	537178	HAPG-81	
	20, 25	35	-	■		564953	DHAA-G-H2-20-B8-35	
	20, 25	40	-	■		537182	HAPG-84	
	25, 32	50	-	■		537185	HAPG-86	
	32	63	-	■		537187	HAPG-87	
	DRQD	HGPL			DHAA, HAPG			
	12, 16	16	■	■	2	564958	DHAA-G-Q5-12-B8-16	
	16 ²⁾	16, 20	■	■		564959	DHAA-G-Q5-16-B8-16	
	12, 16	20	■	■		564955	DHAA-G-Q5-16-B8-20	
	16, 20	25	■	■		537181	HAPG-SD2-25	
	16, 20 ²⁾	25	■	■		544642	HAPG-SD2-48	
	20, 25	35	■	■		537173	HAPG-SD2-23	
	20 ²⁾	35	■	■		544642	HAPG-SD2-48	
	25, 32	40	■	■		537184	HAPG-SD2-26	
	32, 40	50	■	■		564956	DHAA-G-Q5-32-B8-50	
	32 ³⁾	50	■	■		544643	HAPG-SD2-49	
	40, 50	63	■	■		537188	HAPG-SD2-28	

1) Corrosion resistance class 2 according to Festo standard 940 070
Components subject to moderate corrosion stress. Externally visible parts with primarily decorative surface requirements which are in direct contact with a normal industrial environment or media such as coolants or lubricating agents.

2) In combination with DRQD-...-E422 (flanged shaft with energy through-feed).

3) In combination with DRQD-...-E444 (flanged shaft with energy through-feed).

Parallel grippers HYPD, sealed



Accessories



Adapter kit
DHAA, HAPG

Material:
Wrought aluminium alloy
Free of copper and PTFE
RoHS-compliant

 Note
The kit includes the individual mounting interface as well as the necessary mounting material.

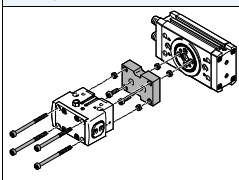
Permissible drive/gripper combinations with adapter kit					Download CAD data → www.festo.com	
Combination	Drive Size	Gripper Size	Mounting option		Adapter kit	
					CRC ¹⁾	Part No. Type
	DRRD	HYPD			DHAA	
	12	16	■	■	2	2449935 DHAA-G-Q11-12-B12-16
	12	20	■	■		2449945 DHAA-G-Q11-12-B12-20
	16	16	■	■		2091914 DHAA-G-Q11-16-B12/B12G-16
	16	20	■	■		2091205 DHAA-G-Q11-16-B12-20
	16	25	■	■		2090715 DHAA-G-Q11-16-B12-25
	20	25	■	■		2088381 DHAA-G-Q11-20-B12-25
	20	35	■	■		2088008 DHAA-G-Q11-20-B12-35
	25	35	■	■		1714646 DHAA-G-Q11-25-B12-35
	25	40	■	■		1715576 DHAA-G-Q11-25-B12-40
	32	40	■	■		2092197 DHAA-G-Q11-32-B12-40
	35	40	■	■		2114998 DHAA-G-Q11-35-B12-40
	32	50	■	■		2124051 DHAA-G-Q11-32-B12-50
	35, 40	50	■	■		2124346 DHAA-G-Q11-35/40-B12-50
	40	63	■	■		2125614 DHAA-G-Q11-40-B12-63
	50	63	■	■		2352692 DHAA-G-Q11-50-B12-63
	50	80	■	■		2412840 DHAA-G-Q11-50-B12-80
	DRRD	HYPD-...-G1/G2			DHAA	
	12	16	■	■	2	2798991 DHAA-G-Q11-12-B12G-16
	12	20	■	■		2800963 DHAA-G-Q11-12-B12G-20
	16	20	■	■		2642948 DHAA-G-Q11-16-B12G-20
	16	25	■	■		2642941 DHAA-G-Q11-16-B12G-25
	20	25	■	■		2642953 DHAA-G-Q11-20-B12G-25
	20	35	■	■		2642961 DHAA-G-Q11-20-B12G-35
	25	35	■	■		2642962 DHAA-G-Q11-25-B12G-35
	25	40	■	■		2642966 DHAA-G-Q11-25-B12G-40
	32	40	■	■		2642967 DHAA-G-Q11-32-B12G-40
	32	50	■	■		2642969 DHAA-G-Q11-32-B12G-50
	35	40	■	■		2643047 DHAA-G-Q11-35-B12G-40
	35, 40	50	■	■		2643100 DHAA-G-Q11-35/40-B12G-50
	40	63	■	■		2643055 DHAA-G-Q11-40-B12G-63
	50	63	■	■		2643096 DHAA-G-Q11-50-B12G-63
50	80	■	■	2643098 DHAA-G-Q11-50-B12G-80		

1) Corrosion resistance class 2 according to Festo standard 940 070
Components subject to moderate corrosion stress. Externally visible parts with primarily decorative surface requirements which are in direct contact with a normal industrial environment or media such as coolants or lubricating agents.

Parallel grippers HYPD, sealed



Accessories

FESTO

Adapter kit
DHAA, HAPG

Material:
Wrought aluminium alloy
Free of copper and PTFE
RoHS-compliant

 Note
The kit includes the individual mounting interface as well as the necessary mounting material.

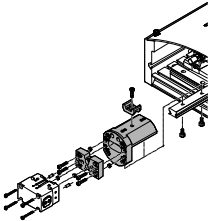
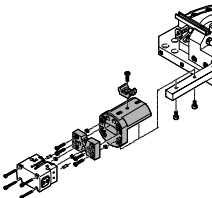
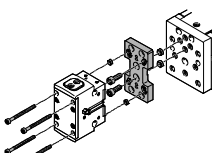
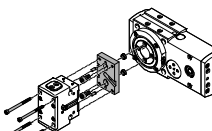
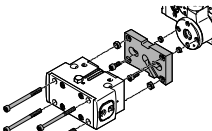
Permissible drive/gripper combinations with adapter kit						Download CAD data → www.festo.com	
Combination	Drive Size	Gripper Size	Mounting option		Adapter kit		
					CRC ¹⁾	Part No.	Type
	HSP	HYPD			DHAA, HAPG		
	12	16	■	–	2	564957	DHAA-G-G6-8-B8-16
						540881	HAPG-70-B
	16	16, 20	■	–		564957	DHAA-G-G6-8-B8-16
						540882	HAPG-71-B
25	16, 20	■	–	564957		DHAA-G-G6-8-B8-16	
					540883	HAPG-72-B	
	HSW	HYPD			DHAA, HAPG		
	12, 16	16	■	–	2	564957	DHAA-G-G6-8-B8-16
						540882	HAPG-71-B
	16	20	■	–		564957	DHAA-G-G6-8-B8-16
				540882		HAPG-71-B	
	EGSL	HYPD			DHAA, HAPG		
	45, 55	25	■	■	2	564952	DHAA-G-G6-16-B8-25
	75	25, 35	■	■		537175	HAPG-79
	75	40	■	■		564951	DHAA-G-G6-20-B8-40
	ERMB	HYPD			DHAA, HAPG		
	20	25	■	■	2	537181	HAPG-SD2-25
	20, 25	35	■	■		537173	HAPG-SD2-23
	25, 32	40	■	■		537184	HAPG-SD2-26
						564956	DHAA-G-Q5-32-B8-50
32	50	■	■				
	EHMB	HYPD			DHAA, HAPG		
	20	40	■	■	2	537184	HAPG-SD2-26
	20, 25, 32	50	■	■		564956	DHAA-G-Q5-32-B8-50
						537188	HAPG-SD2-28
25, 32	63	■	■				

1) Corrosion resistance class 2 according to Festo standard 940 070
Components subject to moderate corrosion stress. Externally visible parts with primarily decorative surface requirements which are in direct contact with a normal industrial environment or media such as coolants or lubricating agents.

Parallel grippers HGPD, sealed

Accessories



Gripper jaw blank BUB-HGPD

(scope of delivery: 2 pieces)

Material:

Wrought aluminium alloy

Free of copper and PTFE

RoHS-compliant

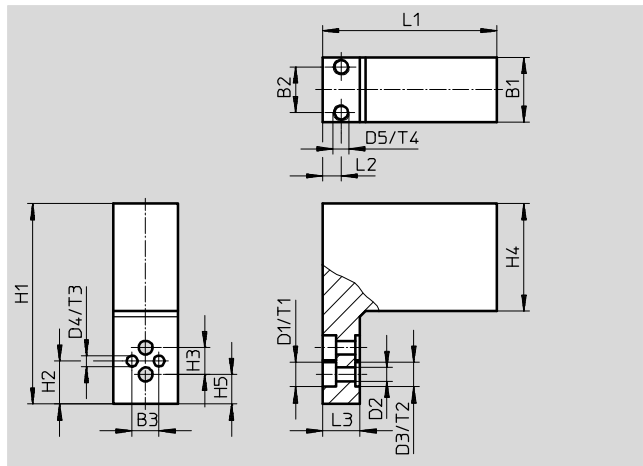
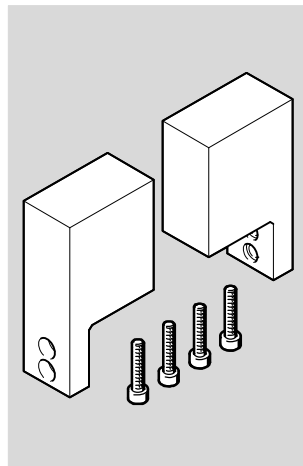

Dimensions and ordering data								
For size	B1	B2	B3	D1	D2	D3	D4	D5
[mm]	±0.05		±0.01	∅ H13	∅ H13	∅ H8	∅ H7	
16	12	8.5	5	4.6	2.6	-	2	M3
20	14	8.5	-	5.9	3.2	5	-	M3
25	20	14	-	7.4	4.3	7	-	M3
35	29	23	-	10.4	6.4	9	-	M3
40	32	26	-	10.4	6.4	9	-	M3
50	35	26	-	10.4	6.4	12	-	M3
63	40	26	-	13.5	8.4	12	-	M3
80	44	26	-	16.5	10.5	15	-	M3

For size	H1	H2	H3	H4	H5	L1	L2	L3
[mm]	±0.05	±0.02				±0.05		
16	37.3	8	5±0.1	20	-	32.5	3.5	7
20	59	-	7±0.01 ¹⁾	35	8	35.5	3	10
25	76	-	10±0.01 ¹⁾	49.5	4.5	44.5	4.5	12
35	92.5	-	12±0.01 ¹⁾	59	7.5	52.5	6	12
40	110	-	15±0.01 ¹⁾	73.5	6	62.5	6	12
50	144	-	18±0.01 ¹⁾	99	11	78	10	15
63	171.5	-	24±0.01 ¹⁾	119	10	98.5	10.5	15
80	198	-	24±0.01 ¹⁾	139	15	120.5	10	20

For size	T1	T2	T3	T4	Weight per blank [g]	Part No.	Type
[mm]	+0.1	+0.1	+0.1				
16	2.5	-	2.1	4	25	1180947	BUB-HGPD-16
20	3.1	1.3	-	5	57	1180948	BUB-HGPD-20
25	4.2	1.6	-	5	138	1180949	BUB-HGPD-25
35	6.2	2.1	-	5	278	1180950	BUB-HGPD-35
40	6.2	2.1	-	5	445	1180951	BUB-HGPD-40
50	6.2	2.6	-	5	814	1180952	BUB-HGPD-50
63	8.2	2.6	-	5	1,340	1180953	BUB-HGPD-63
80	10.2	3.1	-	5	2,170	1180954	BUB-HGPD-80

1) ±0.02 and ±0.01 applies to the centring D3
±0.1 applies to the through-holes D1 and D2

Parallel grippers HGPD, sealed

Accessories

Sensor bracket DASI
(scope of delivery: 1 piece)

Material:
Wrought aluminium alloy
RoHS-compliant

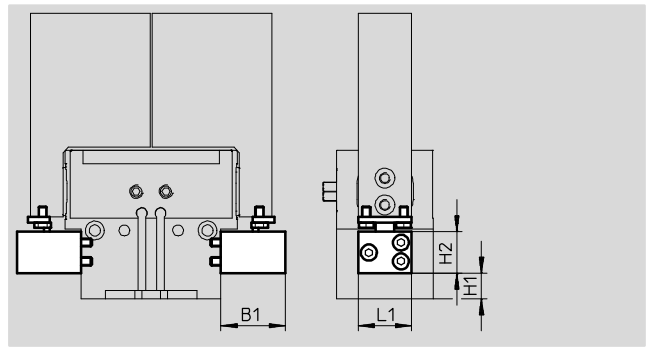
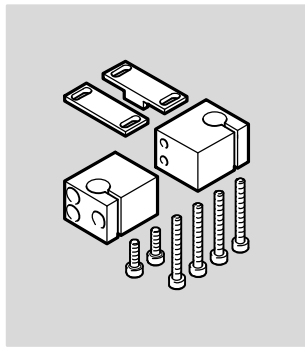

Dimensions and ordering data							
For size	B1	H1		H2	L1	Weight	Part No. Type
[mm]			-G			[g]	
16	18	4.3	11.8	8	18	25	1435225 DASI-B12-16-S3
20	18	2.5	9.5	8	18	22	1435226 DASI-B12-20-S3
25	24	1.5	9.5	15.5	20	50	1435227 DASI-B12-25-S8
35	24	5	21.5	15.5	20	55	1435228 DASI-B12-35-S8
40	29	11.2	29.2	15.6	20	65	1435229 DASI-B12-40-S8
50	34	12	37	16	20	70	1435230 DASI-B12-50-S8
63	54	22	52	16	20	95	1435231 DASI-B12-63-S8
80	54	31	67	16	20	95	1435231 DASI-B12-63-S8

Ordering data						
	For size	Description	Weight	Part No.	Type	PU ¹⁾
	[mm]		[g]			
Centring pin/sleeve ZBS/ZBH Technical data → Internet: zbh						
	16	For centring gripper jaw blanks/gripper fingers on the gripper jaws	1	525273	ZBS-2	10
	20		1	189652	ZBH-5	
	25		1	186717	ZBH-7	
	35, 40		1	150927	ZBH-9	
	50, 63		1	189653	ZBH-12	
	80		3	191409	ZBH-15	
	16, 20		For centring the gripper when mounting	1	189652	
	25, 35	1		186717	ZBH-7	
	40	1		150927	ZBH-9	
	50, 63, 80	1		189653	ZBH-12	
Blanking plug B Technical data → Internet: blanking plug						
	16, 20	For sealing the supply ports	1	30979	B-M3-S9	10
	25, 35, 40		1	174308	B-M5-B	
	50, 63		5	3568	B-1/8	
	80		15	3569	B-1/4	

1) Packaging unit



Parallel grippers HYPD, sealed

Accessories

FESTO



Proximity sensor for size 16 ... 35						
Ordering data – Proximity sensors for C-slot, magneto-resistive						Technical data → Internet: smt
	Type of mounting	Electrical connection, connection direction	Switching output	Cable length [m]	Part No.	Type
N/O contact						
	Insertable in the slot lengthwise	Cable, 3-wire, lateral	PNP	2.5	547862	SMT-10G-PS-24V-E-2,5Q-OE
		Plug M8x1, 3-pin, lateral		0.3	547863	SMT-10G-PS-24V-E-0,3Q-M8D

Proximity sensor for size 40 ... 80						
Ordering data – Proximity sensors for T-slot, magneto-resistive						Technical data → Internet: smt
	Type of mounting	Electrical connection, connection direction	Switching output	Cable length [m]	Part No.	Type
N/O contact						
	Insertable in the slot lengthwise	Cable, 3-wire, lateral	PNP	2.5	547859	SMT-8G-PS-24V-E-2,5Q-OE
		Plug M8x1, 3-pin, lateral		0.3	547860	SMT-8G-PS-24V-E-0,3Q-M8D

Ordering data – Connecting cables						Technical data → Internet: nebu
	Electrical connection, left	Electrical connection, right	Cable length [m]	Part No.	Type	
	Straight socket, M8x1, 3-pin	Cable, open end, 3-wire	2.5	541333	NEBU-M8G3-K-2.5-LE3	
			5	541334	NEBU-M8G3-K-5-LE3	
	Angled socket, M8x1, 3-pin	Cable, open end, 3-wire	2.5	541338	NEBU-M8W3-K-2.5-LE3	
			5	541341	NEBU-M8W3-K-5-LE3	

Proximity sensor for size 16, 20						
Ordering data – Proximity sensors 3 mm (round design), inductive						Technical data → Internet: sieh
	Electrical connection	LED	Switching output	Cable length [m]	Part No.	Type
N/O contact						
	Cable, 3-wire	■	PNP	2.5	538264	SIEH-3B-PS-K-L
	Plug M8x1, 3-pin	■	PNP	–	538263	SIEH-3B-PS-S-L

Proximity sensor for size 25 ... 80						
Ordering data – Proximity sensors M8 (round design), inductive						Technical data → Internet: sien
	Electrical connection	LED	Switching output	Cable length [m]	Part No.	Type
N/O contact						
	Cable, 3-wire	■	PNP	2.5	150386	SIEN-M8B-PS-K-L
	Plug M8x1, 3-pin	■	PNP	–	150387	SIEN-M8B-PS-S-L

Ordering data – Connecting cables						Technical data → Internet: nebu
	Electrical connection, left	Electrical connection, right	Cable length [m]	Part No.	Type	
	Straight socket, M8x1, 3-pin	Cable, open end, 3-wire	2.5	541333	NEBU-M8G3-K-2.5-LE3	
			5	541334	NEBU-M8G3-K-5-LE3	
	Angled socket, M8x1, 3-pin	Cable, open end, 3-wire	2.5	541338	NEBU-M8W3-K-2.5-LE3	
			5	541341	NEBU-M8W3-K-5-LE3	