

Three-point grippers HGDD, sealed

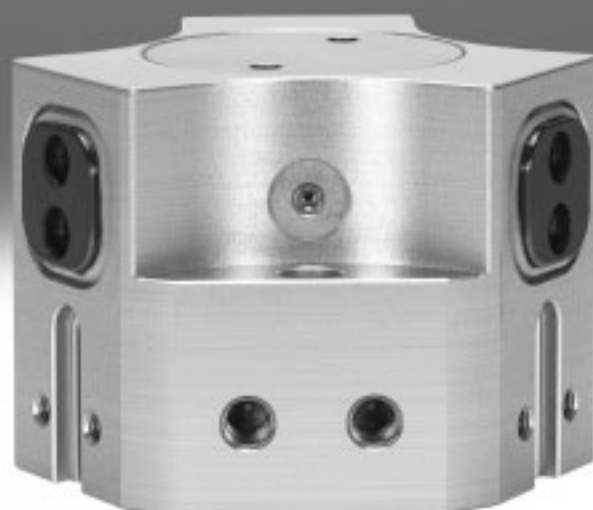

Three-point grippers HGDD, sealed

Key features

At a glance

General information

The fully encapsulated gripper kinematics enable the gripper to be used in extremely harsh ambient conditions.

Sturdy and precise kinematics for maximum torque resistance and long service life.

The force generated by the linear motion is translated into the gripper jaw movement via a wedge mechanism

with forced motion sequence. This also guarantees synchronous movement of the gripper jaw. The ground gripper jaws and slideway ensure a virtually backlash-free movement.

Flexible range of applications

- Can be used as a double-acting and single-acting gripper
- Compression spring for supplementary or retaining gripping forces
- Suitable for external and internal gripping

The technology in detail

Gripper closed

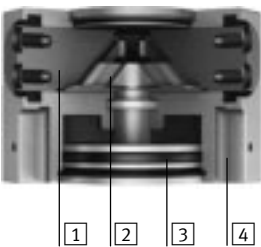

Gripper open



- 1 Gripper jaw
- 2 Wedge with forced guidance
- 3 Piston with magnet
- 4 Slot for proximity sensor

-  - Note

Gripper selection sizing software

→ www.festo.com

Wide range of supply ports

Direct

From the front

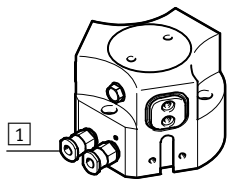

- 1 Supply ports
- 2 O-rings

Via adapter plate

From underneath

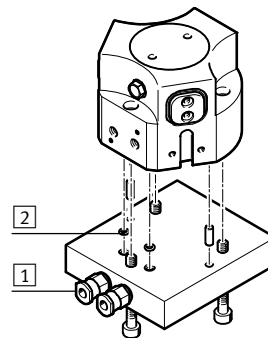

Other ports

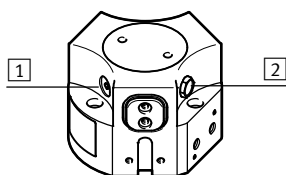

- 1 Port for lubrication nipple
- 2 Exhaust hole or sealing air port

Use in harsh ambient conditions

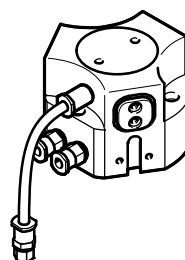

When using the gripper in damp environments or with liquid/gaseous media, make sure that the filter is installed in a neutral environment. The same applies to unused supply ports when operating the gripper as a single-acting gripper.

Three-point grippers HGDD, sealed

Key features

Mounting options

Direct mounting
From above

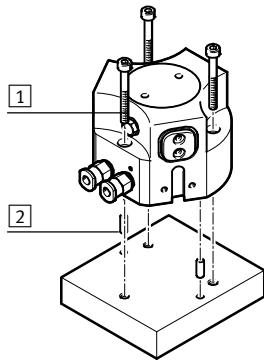

- 1 Mounting screws
- 2 Centring pins

Via adapter plate
From underneath

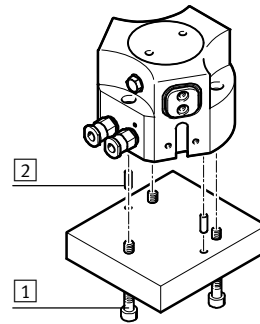

Note
These grippers are not suitable or are of limited suitability for the following sample applications:

Not suitable for:

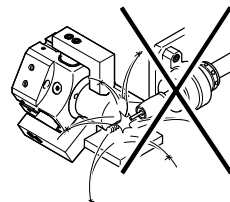

- Welding spatter

Of limited suitability for:

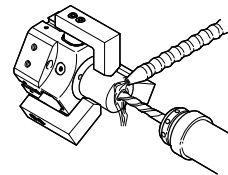

- Aggressive media only possible after consultation with Festo

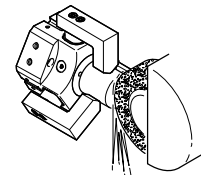

- Grinding dust

Three-point grippers HGDD, sealed

Type codes

HGDD – 35 – A – G1

Type

HGDD	Three-point gripper
------	---------------------

Size

Position sensing

A	Via proximity sensor
---	----------------------

Gripping force retention

G1	Opening
----	---------

G2	Closing
----	---------

Three-point grippers HGDD, sealed

Peripherals overview

FESTO

Peripherals overview

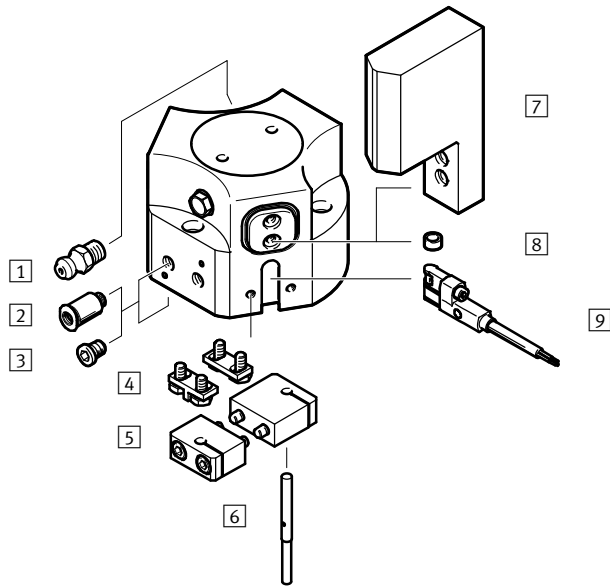

System product for handling and assembly technology

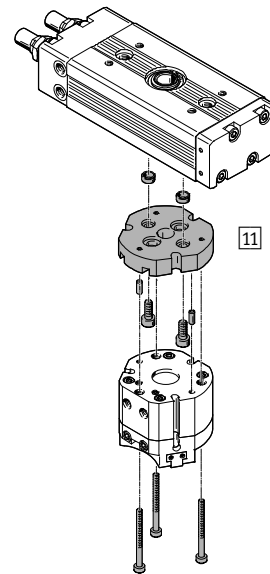

Proportional pressure regulator VPPM

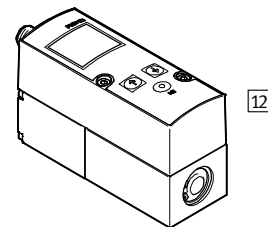

Accessories			
Type	Brief description	→ Page/Internet	
1	Lubrication nipple	Included in the scope of delivery of the gripper	-
2	Push-in fitting QS	For connecting compressed air tubing with standard O.D.	quick star
3	Blanking plug B	For sealing the supply ports when using the lower supply ports	17
4	Sensor bracket DASI	Switch lug for sensing the gripper jaw position. Mounted on the gripper jaw blank	17
5	Sensor bracket DASI	Clamping block for securing the proximity sensors SIEH or SIEN	17
6	Proximity sensor SIEH/SIEN	For sensing the piston position	18
7	Gripper jaw blank BUB-HGDD	Blank specially matched to the gripper jaws for custom fabrication of gripper fingers	16
8	Centring sleeve ZBH	<ul style="list-style-type: none"> For centring gripper jaw blanks/gripper fingers on the gripper jaws 6 centring sleeves included in the scope of delivery of the gripper 	17
9	Proximity sensor SMT-8G	<ul style="list-style-type: none"> For sensing the piston position, 3 slots available Proximity sensor does not project past the housing at the bottom 	17
11	Adapter plate DHAA	Connecting plate between drive and gripper	14
12	Proportional pressure regulator VPPM	For infinite adjustment of the gripping force	vppm

Three-point grippers HGDD, sealed

Technical data

FESTO

Function
Double-acting
HGDD-...

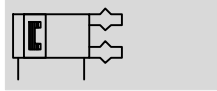

Size
35 ... 80 mm

Stroke
4 ... 12 mm

www.festo.com

Function – Variants
Single-acting or
with gripping force retention ...
... opening HGDD-...-G1



... closing HGDD-...-G2



General technical data						
Size		35	40	50	63	80
Design		Wedge-shaped actuator Forced motion sequence				
Mode of operation		Double-acting				
Gripper function		3-point				
Number of gripper jaws		3				
Max. load per external gripper finger ¹⁾	[g]	57	130	276	440	790
Stroke per gripper jaw	[mm]	4	6	8	10	12
Pneumatic connection		M5	M5	G $\frac{1}{8}$	G $\frac{1}{8}$	G $\frac{1}{8}$
Pneumatic connection for sealing air		M3	M3	M5	M5	G $\frac{1}{8}$
Pneumatic connection for lubrication nipple		M3	M3	M5	M5	M5
Repetition accuracy ²⁾	[mm]	$\leq \pm 0.03$			$\leq \pm 0.05$	
Max. interchangeability	[mm]	$\leq \pm 0.2$				
Max. operating frequency	[Hz]	≤ 4				
Rotational symmetry	[mm]	$< \varnothing 0.2$				
Position sensing		Via proximity sensor				
Type of mounting		Via through-hole and dowel pin Via female thread and dowel pin				
Mounting position		Any				

1) Valid for unthrottled operation

2) End-position drift under constant conditions of use with 100 consecutive strokes, concentric to the central shaft

Operating and environmental conditions		
Min. operating pressure		
HGDD-...-A	[bar]	3
HGDD-...-A-G	[bar]	4
Max. operating pressure	[bar]	8
Operating pressure for sealing air	[bar]	0 ... 0.5
Operating medium		Compressed air in accordance with ISO 8573-1:2010 [7:4:4]
Note on operating/pilot medium		Operation with lubricated medium possible (in which case lubricated operation will always be required)
Ambient temperature ¹⁾	[°C]	+5 ... +60
Corrosion resistance class CRC ²⁾		2

1) Note operating range of proximity sensors

2) Corrosion resistance class 2 according to Festo standard 940 070

Components subject to moderate corrosion stress. Externally visible parts with primarily decorative surface requirements which are in direct contact with a normal industrial environment or media such as coolants or lubricating agents.

Three-point grippers HGDD, sealed

Technical data

FESTO

Weight [g]					
Size	35	40	50	63	80
HGDD-...-A	309	599	1,117	2,175	3,522
HGDD-...-A-G	370	775	1,495	2,848	4,788

Materials

Sectional view

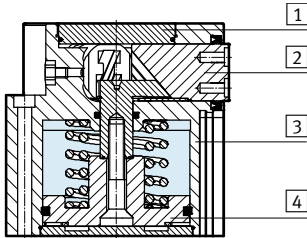

Size	35	40	50	63	80
1 Cover cap	High-alloy stainless steel				
2 Gripper jaw	Hardened steel				
3 Housing	Anodised aluminium				
4 Piston	Hard anodised aluminium				
- Seals	Nitrile rubber				
- Note on materials	Free of copper and PTFE			-	
	RoHS-compliant				

Gripping force [N] at 6 bar

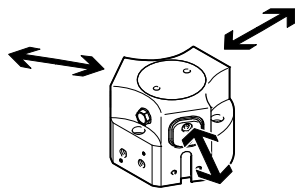

Size	35	40	50	63	80	
Gripping force per gripper jaw						
HGDD-...-A	Opening	122	216	371	582	943
	Closing	112	200	348	553	915
Total gripping force						
HGDD-...-A	Opening	366	648	1,113	1,746	2,829
	Closing	336	600	1,044	1,659	2,745

Characteristic load values at the gripper jaws

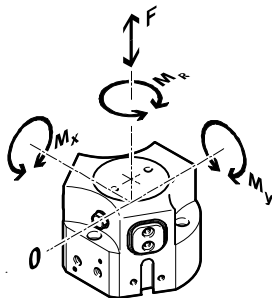

The indicated permissible forces and torques apply to a single gripper jaw. They include the lever arm, additional applied loads due to the workpiece or external gripper fingers and acceleration forces occurring during movement.

The zero coordinate line (gripper finger point of rotation) must be taken into consideration for the calculation of torques.

Size	35	40	50	63	80	
Max. permissible force F_z	[N]	300	700	1,300	2,300	3,600
Max. permissible torque M_x	[Nm]	12	25	45	70	100
Max. permissible torque M_y	[Nm]	8	18	30	45	65
Max. permissible torque M_r	[Nm]	8	20	30	50	75

Three-point grippers HGDD, sealed

Technical data

Mass moment of inertia [kgcm²]

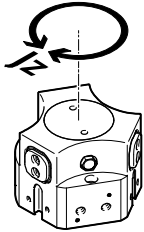

Mass moment of inertia of the three-point gripper in relation to the central axis, without external gripper fingers, without load.

Size	35	40	50	63	80
HGDD-...-A	1.01	3.31	9.65	29	70.22
HGDD-...-A-G	1.37	5.01	15.07	45.05	109

Gripper jaw backlash

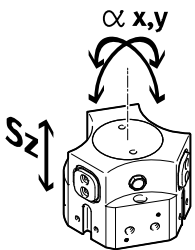

The plain-bearing guide used in the grippers means that there is backlash between the gripper jaws and the guide element. The values entered in the table for the backlash were calculated in accordance with the traditional accumulative tolerance method.

Size	35	40	50	63	80
Max. gripper jaw backlash Sz [mm]	0.05				
Max. gripper jaw angular backlash ax, ay [°]	0.1				

Opening and closing times [ms] at 6 bar

Without external gripper fingers

With external gripper fingers

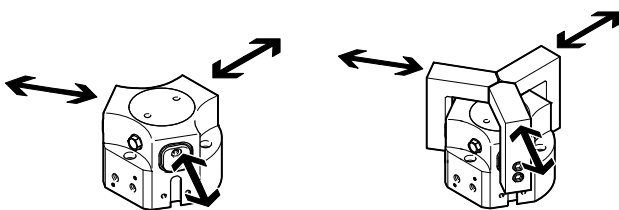

The indicated opening and closing times [ms] were measured at room temperature at an operating pressure of 6 bar with horizontally mounted grippers without additional gripper

fingers. The grippers must be throttled for greater loads [g]. Opening and closing times must then be adjusted accordingly.

Size	35	40	50	63	80	
Without external gripper fingers						
HGDD-...-A	Opening	44	78	93	115	152
	Closing	52	106	128	145	142
HGDD-...-A-G1	Opening	38	70	25	48	72
	Closing	85	211	160	190	246
HGDD-...-A-G2	Opening	81	144	111	135	159
	Closing	42	110	87	68	107
With external gripper fingers per gripper finger (as a function of the load)						
HGDD-...	200 g	52	-	-	-	-
	400 g	74	70	-	-	-
	500 g	83	78	-	-	-
	800 g	105	99	106	-	-
	1,000 g	-	111	118	128	-
	1,500 g	-	-	145	157	209
	1,800 g	-	-	-	172	229
	2,000 g	-	-	-	181	241
	2,200 g	-	-	-	-	253
	2,400 g	-	-	-	-	264

Three-point grippers HGDD, sealed

Technical data

Gripping force F_H per gripper jaw as a function of operating pressure and lever arm x

The gripping forces as a function of operating pressure and lever arm can be determined from the following graphs.

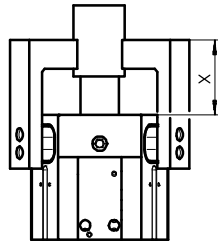

- 3 bar
- - - 6 bar
- · - 8 bar

Note
Gripper selection
sizing software
→ www.festo.com

External gripping (closing)

HGDD-35-A

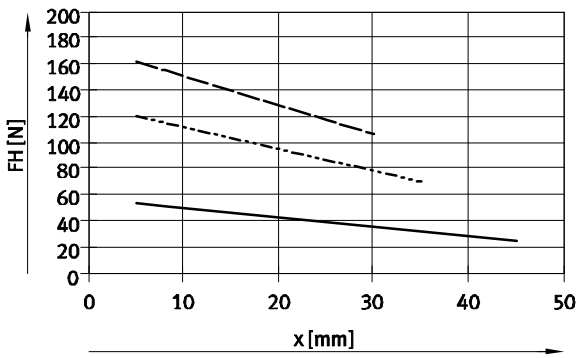

HGDD-40-A

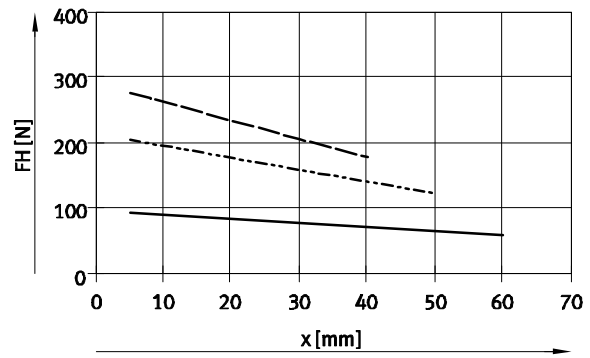

HGDD-50-A

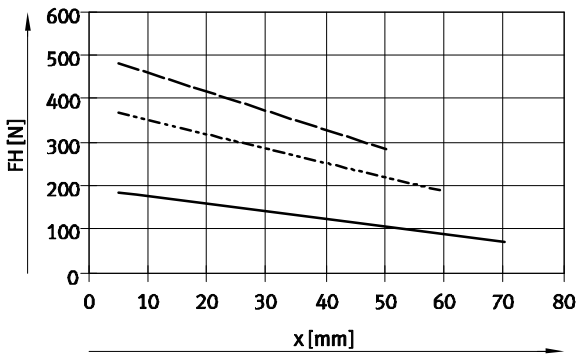

HGDD-63-A

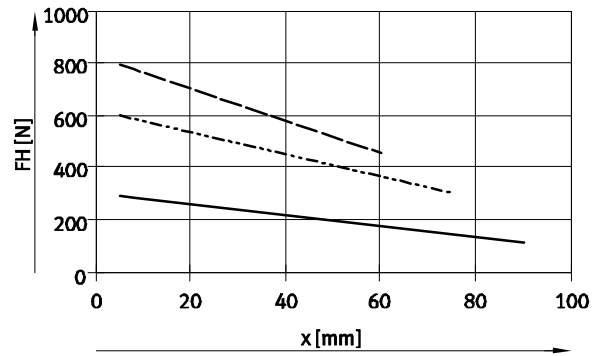

HGDD-80-A

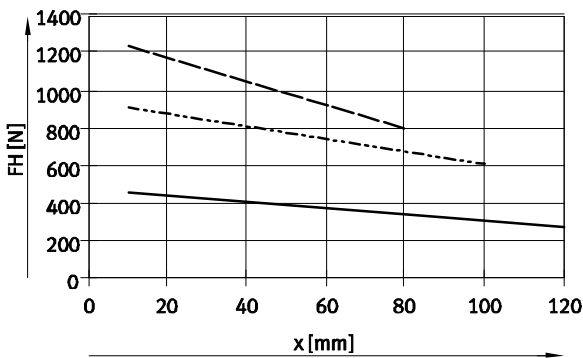

Three-point grippers HGDD, sealed

Technical data

Gripping force F_H per gripper jaw as a function of operating pressure and lever arm x

The gripping forces as a function of operating pressure and lever arm can be determined from the following graphs.

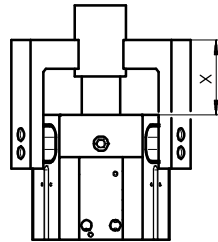

- 3 bar
- - - 6 bar
- · - 8 bar

Note
Gripper selection
sizing software
→ www.festo.com

Internal gripping (opening)

HGDD-35-A

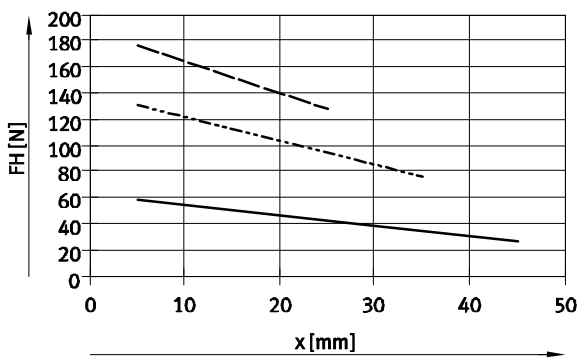

HGDD-40-A

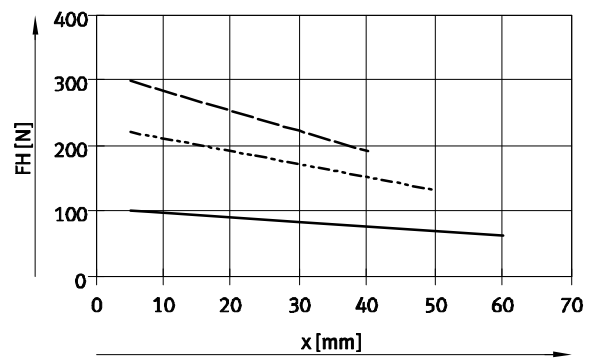

HGDD-50-A

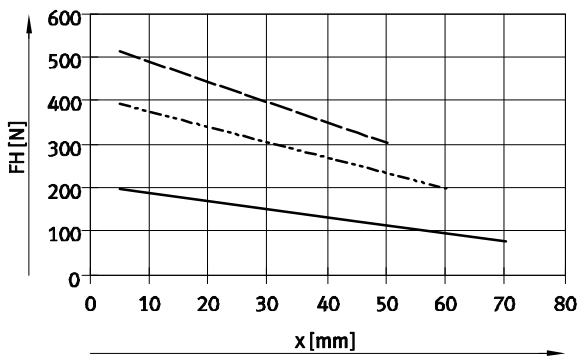

HGDD-63-A

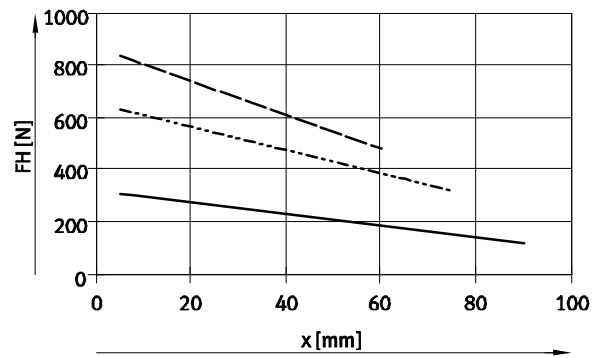

HGDD-80-A

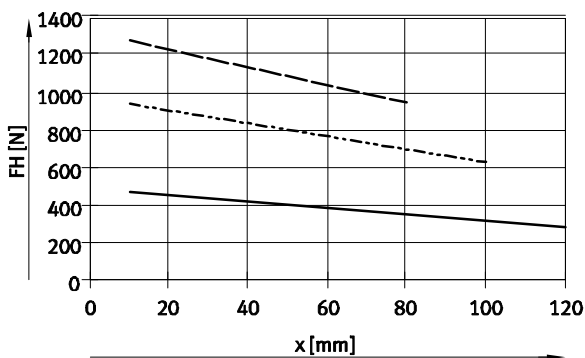

Three-point grippers HGDD, sealed

Technical data

Spring force F_F as a function of size and gripper jaw stroke l per gripper finger

Gripping force retention for HGDD-...-G...

The spring forces F_F as a function of gripper jaw stroke can be determined from the following graph.

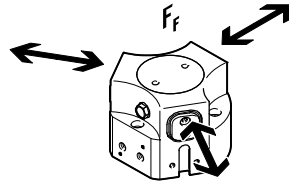

Size 35 ... 50

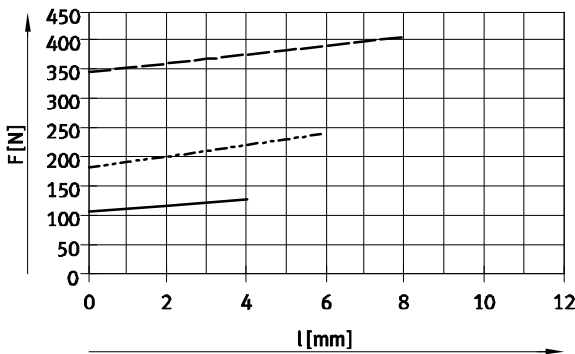

— HGDD-35-A-G
 - - - HGDD-40-A-G
 - · - HGDD-50-A-G

Size 63 ... 80

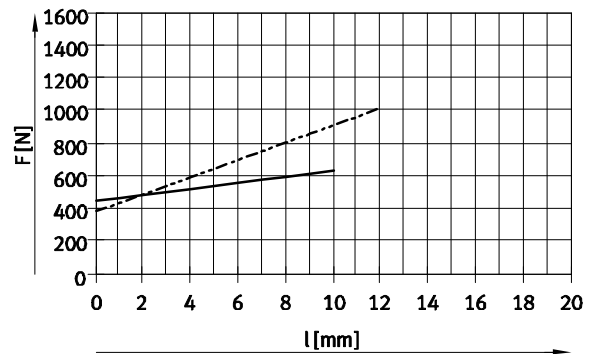

— HGDD-63-A-G
 - - - HGDD-80-A-G

Spring force F_F as a function of size, gripper jaw stroke l and lever arm x per gripper finger

The lever arm x must be taken into consideration when determining the actual spring force F_{Ftotal} .

The formulae for calculating the spring force are provided in the table below.

Gripping force retention	Size	F_{Ftotal} per gripper finger
G1	35	$-0.85 \cdot x + 0.45 \cdot F_F$
	40	$-0.55 \cdot x + 0.35 \cdot F_F$
	50	$-2.5 \cdot x + 0.75 \cdot F_F$
	63	$-0.2 \cdot x + 0.4 \cdot F_F$
	80	$-1.5 \cdot x + 0.35 \cdot F_F$

Gripping force retention	Size	F_{Ftotal} per gripper finger
G2	35	$-0.6 \cdot x + 0.45 \cdot F_F$
	40	$-0.55 \cdot x + 0.35 \cdot F_F$
	50	$-2.5 \cdot x + 0.6 \cdot F_F$
	63	$-1.0 \cdot x + 0.4 \cdot F_F$
	80	$-4.0 \cdot x + 0.85 \cdot F_F$

Determination of the actual gripping forces F_{Gr} for HGDD-...-G1 and HGDD-...-G2 as a function of application

The three-point grippers with integrated spring type HGDD-...-G1 (opening gripping force retention) and HGDD-...-G2 (closing gripping force retention) can be used as

- single-acting grippers

- grippers with supplementary gripping force and
- grippers with gripping force retention depending on requirements.

In order to calculate the available gripping forces F_{Gr} (per gripper finger), the gripping force (F_H) and spring force (F_{Ftotal}) must be combined accordingly.

Application forces per gripper finger

Single-acting	Supplementary gripping force	Gripping force retention
<ul style="list-style-type: none"> • Gripping with spring force: $F_{Gr} = F_{Ftotal}$ • Gripping with pressure force: $F_{Gr} = F_H - F_{Ftotal}$ 	<ul style="list-style-type: none"> • Gripping with pressure and spring force: $F_{Gr} = F_H + F_{Ftotal}$ 	<ul style="list-style-type: none"> • Gripping with spring force: $F_{Gr} = F_{Ftotal}$

Three-point grippers HGDD, sealed

Technical data

FESTO

Dimensions

Download CAD data → www.festo.com

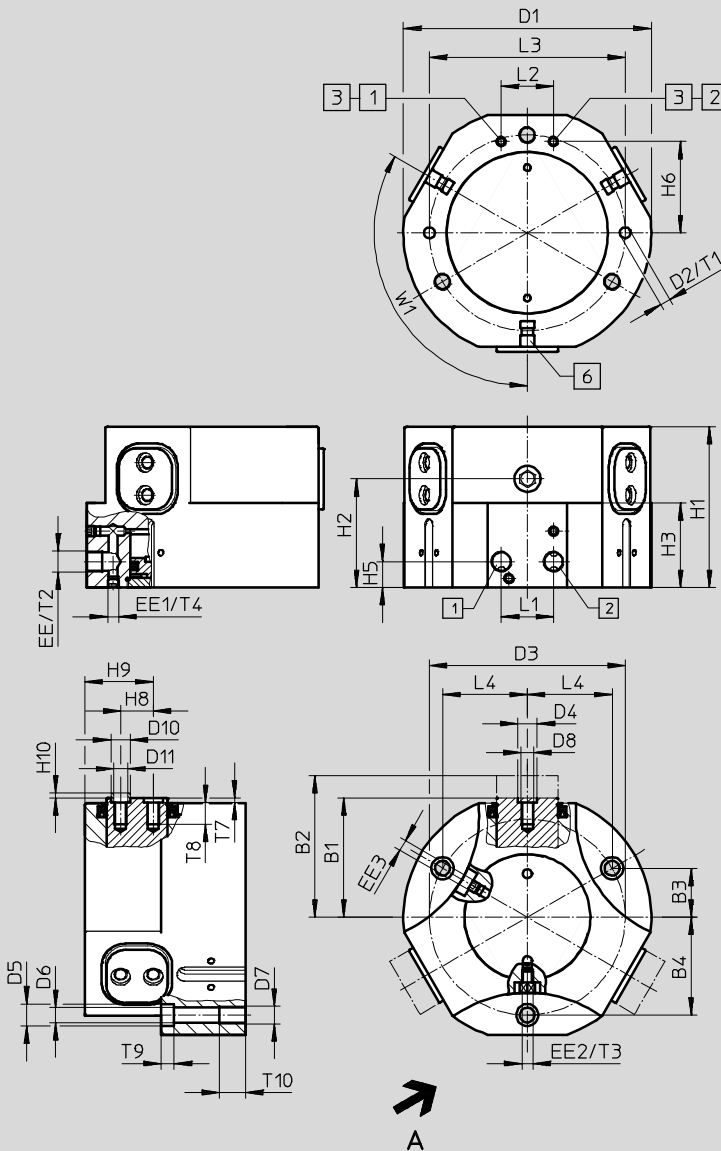

View A

- 1 Supply port, opening
- 2 Supply port, closing
- 3 Alternative supply port (supplied sealed)
- 4 Exhaust hole (filter integrated)
- 5 Lubrication nipple (supplied sealed)
- 6 Slot for proximity sensor
- 7 O-ring for three-point gripper
HGDD-35: \varnothing 3x1.5
HGDD-40 ... 80: \varnothing 5x1.5

Three-point grippers HGDD, sealed

Technical data

Size	B1	B2	B3	B4	D1	D2	D3	D4	D5	D6	D7	D8	D9
[mm]	±0.5	±0.5			∅ ±0.1	∅ H8	∅ ±0.1	∅ H8	∅ H13	∅ H13			
35	28	32	11	22	58	3	44	5	5.9	3.3	M4	M3	M3
40	36	42	14	28	74	4	56	7	9.4	5.1	M6	M4	M3
50	44.5	52.5	17.5	35	93	5	70	9	10.2	6.8	M8	M6	M3
63	55	65	22.5	45	114	5	90	9	10.2	6.8	M8	M6	M3
80	68	80	28	56	139	6	112	9	13.5	8.4	M10	M6	M3

Size	D10	D11	D12	EE	EE1	EE2	EE3	H1		H2	
	∅ h7	∅	∅ +0.2					±0.05	-G ±0.05		-G
35	5	3.2	6	M5	M3	M3	M3	41	51	29	39
40	7	5.3	8	M5	M5	M3	M3	48.5	66	34.5	52
50	9	6.4	8	G $\frac{3}{8}$	M5	M5	M5	58.5	83.5	40.4	65.4
63	9	6.4	8	G $\frac{3}{8}$	M5	M5	M5	74	104	50	80
80	9	6.4	8	G $\frac{3}{8}$	M5	G $\frac{3}{8}$	M5	83.5	120.5	55.5	92.5

Size	H3		H5	H6	H7		H8 ¹⁾	H9	H10	L1	L2	L3	L4
	-0.2	-G -0.2	±0.1	±0.1	±0.1	-G ±0.1		-0.02	-0.3	±0.1	±0.1	±0.02	
35	23	33	9	18.5	7	17	7	15.5	1.2	12	15	45	19.05
40	27.5	45	9	25	10	27.5	10	19	1.4	12	18	56	24.25
50	32.5	57.5	12	32	12.5	37.5	12	24.1	1.9	24	18	70	30.31
63	39	69	12	42	16	46	15	31.5	1.9	24	24	90	38.97
80	43	80	12	53	21	58	18	37	1.9	30	30	112	48.5

Size	L5	L6	T1	T2	T3	T4	T5	T6	T7	T8	T9	T10	W1
[mm]	-0.02	±0.1	min.	min.	min.	min.	+0.1	min.	+0.1	min.	+0.2	min.	
35	14	12	5	5	3	3	1.2	4	1.3	5	3.2	8	120°
40	18	12	6	6	3	5	1.2	5	1.6	6	5	10	120°
50	22	12	8	7	6	5	1.2	5	2.1	10	6.1	12	120°
63	28	14	8	7	6	5	1.2	5	2.1	10	6.1	12	120°
80	32	14	10	8	10	5	1.2	5	2.1	10	8	15	120°

1) Tolerance for centring hole ±0.02 mm
Tolerance for thread ±0.1 mm

Ordering data						
Size	Double-acting without compression spring		Single-acting or with gripping force retention			
	Part No.	Type	Opening		Closing	
[mm]			Part No.	Type	Part No.	Type
35	1163037	HGDD-35-A	1163038	HGDD-35-A-G1	1163039	HGDD-35-A-G2
40	1163040	HGDD-40-A	1163041	HGDD-40-A-G1	1163042	HGDD-40-A-G2
50	1163043	HGDD-50-A	1163044	HGDD-50-A-G1	1163045	HGDD-50-A-G2
63	1163046	HGDD-63-A	1163047	HGDD-63-A-G1	1163048	HGDD-63-A-G2
80	1163049	HGDD-80-A	1163050	HGDD-80-A-G1	1163051	HGDD-80-A-G2

Three-point grippers HGDD, sealed

Accessories

FESTO

Adapter kit
DHAA, HAPG

Material:
Wrought aluminium alloy
Free of copper and PTFE
RoHS-compliant



Note

The kit includes the individual mounting interface as well as the necessary mounting material.

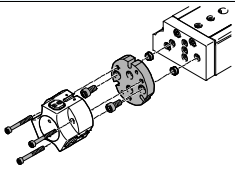
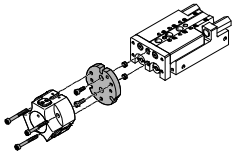
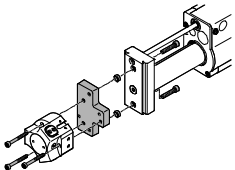
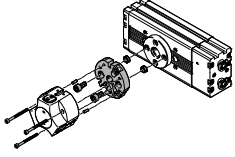
Permissible drive/gripper combinations with adapter kit						Download CAD data → www.festo.com
Combination	Drive	Gripper	Adapter kit			
			CRC ¹⁾	Part No.	Type	
	DGSL	HGDD	DHAA			
	16, 20, 25	35	2	2371422	DHAA-G-G3-20-B13-35	
	20, 25	40		2373773	DHAA-G-H2-16-B13-40	
	25	50		2377625	DHAA-G-H2-20-B13-50	
	DGSL	HGDD-G1/G2	DHAA/HAPG			
	16, 20, 25	35	2	542436	HAPG-94	
	20, 25	40		542437	HAPG-95	
	25	50		2378415	DHAA-G-H2-20-B13G-50	
		SLT	HGDD	DHAA		
		16	35	2	2360918	DHAA-G-G3-16-B13-35
20, 25		35	2371422		DHAA-G-G3-20-B13-35	
20, 25		40	2373773		DHAA-G-H2-16-B13-40	
25		50	2377625		DHAA-G-H2-20-B13-50	
SLT		HGDD-G1/G2	DHAA/HAPG			
16		35	2	542435	HAPG-99	
20, 25		35		542436	HAPG-94	
20, 25		40		542437	HAPG-95	
25		50		2378415	DHAA-G-H2-20-B13G-50	
	HMP	HGDD	DHAA			
	16	35	2	2350468	DHAA-G-H2-16-B13-35	
	16, 20, 25	40		2373773	DHAA-G-H2-16-B13-40	
	20, 25, 32	50		2377625	DHAA-G-H2-20-B13-50	
	25, 32	63		2367926	DHAA-G-H2-25-B13-63	
	HMP	HGDD-G1/G2	DHAA/HAPG			
	16	35	2	542434	HAPG-98	
	16, 20, 25	40		542437	HAPG-95	
	20, 25, 32	50		2378415	DHAA-G-H2-20-B13G-50	
	25, 32	63		2367800	DHAA-G-H2-25-B13G-63	
	DRQD	HGDD	DHAA/HAPG			
	20, 25, 32	35	2	2376297	DHAA-G-Q5-20-B13-35	
	25, 32	40		2376728	DHAA-G-Q5-25-B13-40	
	32	50		2377625	DHAA-G-H2-20-B13-50	
	32 ³⁾	50		542443	HAPG-SD2-36	
	DRQD	HGDD-G1/G2	DHAA/HAPG			
	20, 25, 32	35	2	542441	HAPG-SD2-34	
	20 ²⁾ , 25, 32 ³⁾	35		542441	HAPG-SD2-34	
	25, 32	40		542442	HAPG-SD2-35	
	25, 32 ³⁾	40		542442	HAPG-SD2-35	
32	50	2378415		DHAA-G-H2-20-B13G-50		

- Corrosion resistance class 2 according to Festo standard 940 070
Components subject to moderate corrosion stress. Externally visible parts with primarily decorative surface requirements which are in direct contact with a normal industrial environment or media such as coolants or lubricating agents.
- In combination with DRQD-...-E422 (flanged shaft with energy through-feed).
- In combination with DRQD-...-E444 (flanged shaft with energy through-feed).

Three-point grippers HGDD, sealed

Accessories

FESTO

Adapter kit
DHAA/HAPG

Material:
Wrought aluminium alloy
Free of copper and PTFE
RoHS-compliant

 Note
The kit includes the individual mounting interface as well as the necessary mounting material.

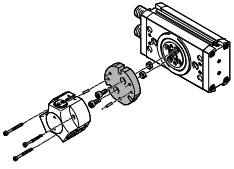
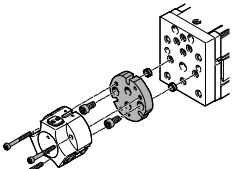
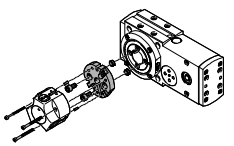
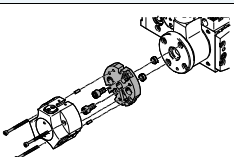
Permissible drive/gripper combinations with adapter kit				Download CAD data → www.festo.com		
Combination	Drive	Gripper	Adapter kit			
	Size	Size	CRC ¹⁾	Part No.	Type	
	DRRD	HGDD	DHAA			
	20	35	2	2075498	DHAA-G-Q11-20-B13-35	
	25	35		1718041	DHAA-G-Q11-25-B13-35	
	25	40		1718564	DHAA-G-Q11-25-B13-40	
	32	40		2077119	DHAA-G-Q11-32-B13-40	
	32	50		2078975	DHAA-G-Q11-32-B13-50	
	35	50		2079171	DHAA-G-Q11-35-B13-50	
	35, 40	63		2079579	DHAA-G-Q11-35/40-B13-63	
	DRRD	HGDD-G1/G2		DHAA		
	20	35	2	2837144	DHAA-G-Q11-20-B13G-35	
	25	35		2837169	DHAA-G-Q11-25-B13G-35	
	25	40		2837182	DHAA-G-Q11-25-B13G-40	
	32	40		2837254	DHAA-G-Q11-32-B13G-40	
	32	50		2837269	DHAA-G-Q11-32-B13G-50	
	35	50		2837283	DHAA-G-Q11-35-B13G-50	
	35, 40	63		2837337	DHAA-G-Q11-35/40-B13G-63	
	EGSL/HGDD	EGSL		HGDD	DHAA	
		45, 55, 75	35	2	2371422	DHAA-G-G3-20-B13-35
75		40	2373773		DHAA-G-H2-16-B13-40	
75		50	2377625		DHAA-G-H2-20-B13-50	
EGSL		HGDD-G1/G2	DHAA/HAPG			
45, 55, 75		35	2	542436	HAPG-94	
75		40		542437	HAPG-95	
75		50		2378415	DHAA-G-H2-20-B13G-50	
ERMB/HGDD		ERMB		HGDD	DHAA	
	20, 25, 32	35	2	2376297	DHAA-G-Q5-20-B13-35	
	25, 32	40		2376728	DHAA-G-Q5-25-B13-40	
	32	50		2377625	DHAA-G-H2-20-B13-50	
	ERMB	HGDD-G1/G2	DHAA/HAPG			
	20, 25, 32	35	2	542441	HAPG-SD2-34	
	25, 32	40		542442	HAPG-SD2-35	
	32	50		2378415	DHAA-G-H2-20-B13G-50	
EHMB/HGDD	EHMB	HGDD	DHAA			
	20	35	2	2376297	DHAA-G-Q5-20-B13-35	
	20	40		2376728	DHAA-G-Q5-25-B13-40	
	20	50		2377625	DHAA-G-H2-20-B13-50	
	EHMB	HGDD-G1/G2	DHAA/HAPG			
	20	35	2	542441	HAPG-SD2-34	
	20	40		542442	HAPG-SD2-35	
	20	50		2378415	DHAA-G-H2-20-B13G-50	

1) Corrosion resistance class 2 according to Festo standard 940 070
Components subject to moderate corrosion stress. Externally visible parts with primarily decorative surface requirements which are in direct contact with a normal industrial environment or media such as coolants or lubricating agents.

Three-point grippers HGDD, sealed

Accessories

Gripper jaw blank BUB-HGDD

(scope of delivery: 3 pieces)

Material:

Wrought aluminium alloy

Free of copper and PTFE

RoHS-compliant

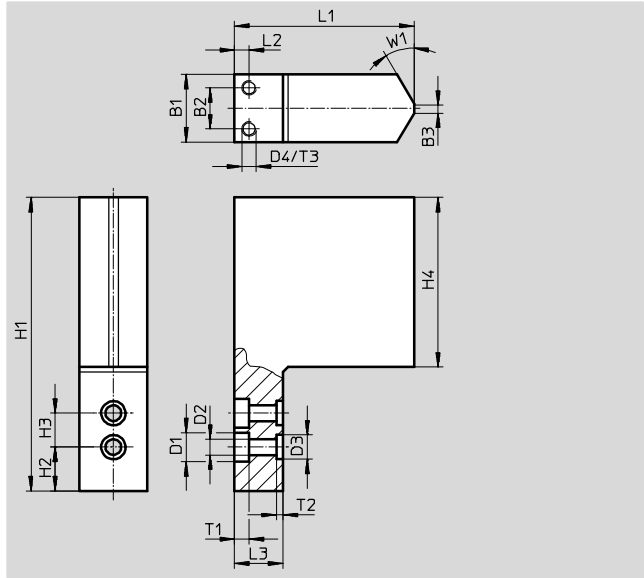
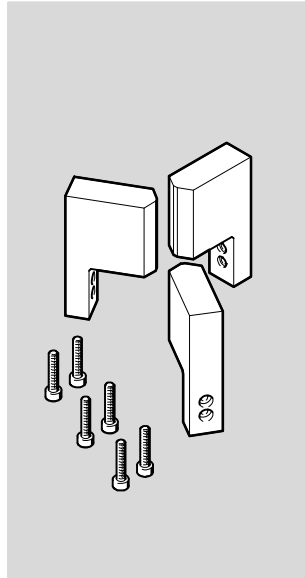

Dimensions and ordering data							
For size	B1	B2	B3	D1	D2	D3	D4
[mm]	±0.05			∅ H13	∅ H13	∅ H8	
35	14	8.5	2	5.9	3.2	5	M3
40	20	14	2	7.4	4.3	7	M3
50	29	23	2	10.4	6.4	9	M3
63	32	26	2	10.4	6.4	9	M3
80	35	26	2	10.4	6.4	9	M3

For size	H1	H2	H3 ¹⁾	H4	L1	L2	L3
[mm]	±0.05	±0.02			±0.05		
35	60.5	9	7	35	37	3	10
40	77	7	10	50	45	5	10
50	96	11	12	60	55	6	12
63	121	13.5	15	75	64	6	12
80	153.5	15.5	18	100	79.4	10	15

For size	T1	T2	T3	W1	Weight per blank [g]	Part No.	Type
[mm]		+0.1					
35	3 ^{+0.2}	1.3	5	30°	57	1180955	BUB-HGDD-35
40	4 ^{+0.2}	1.6	5	30°	131	1180956	BUB-HGDD-40
50	6.1 ^{+0.1}	2.1	5	30°	276	1180957	BUB-HGDD-50
63	6.1 ^{+0.1}	2.1	5	30°	440	1180958	BUB-HGDD-63
80	6.1 ^{+0.1}	2.1	5	30°	793	1180959	BUB-HGDD-80

1) ±0.02 and ±0.01 applies to the centring D3
±0.1 applies to the through-holes D1 and D2

Three-point grippers HGDD, sealed



Accessories

Sensor bracket DASI
(scope of delivery: 1 piece)

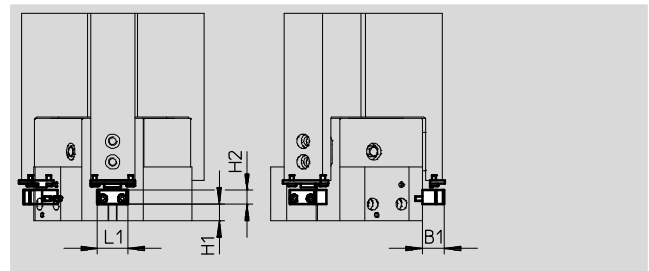
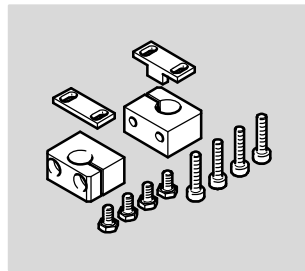
Material:
Wrought aluminium alloy
RoHS-compliant





Dimensions and ordering data							
For size	B1	H1		H2	L1	Weight	Part No. Type
[mm]			-G			[g]	
35	13	3	13	8	21	20	1435236 DASI-B13-35-S3
40	16	6	23.5	10	20	27	1435232 DASI-B13-40-S8
50	16	8.5	33.5	10	20	30	1435233 DASI-B13-50-S8
63	16	10	36	10	22	35	1435234 DASI-B13-63-S8
80	22	10	47	15	22	45	1435235 DASI-B13-80-S8

Ordering data						
	For size [mm]	Comment	Weight [g]	Part No.	Type	PU ¹⁾
Centring sleeve ZBH Technical data → Internet: zbh						
	35	For centring gripper jaw blanks/gripper fingers on the gripper jaws	1	189652	ZBH-5	10
	40		1	186717	ZBH-7	
	50, 63, 80		1	150927	ZBH-9	
Blanking plug B Technical data → Internet: blanking plug						
	35, 40	For sealing the supply ports	1	174308	B-M5-B	10
	50, 63, 80		5	3568	B-1/8	

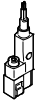

1) Packaging unit



Ordering data – Proximity sensors for T-slot, magneto-resistive						Technical data → Internet: smt
	Type of mounting	Electrical connection, connection direction	Switching output	Cable length [m]	Part No.	Type
N/O contact						
	Insertable in the slot lengthwise	Cable, 3-wire, lateral	PNP	2.5	547859	SMT-8G-PS-24V-E-2,5Q-OE
		Plug M8x1, 3-pin, lateral		0.3	547860	SMT-8G-PS-24V-E-0,3Q-M8D



Ordering data – Connecting cables					Technical data → Internet: nebu
	Electrical connection, left	Electrical connection, right	Cable length [m]	Part No.	Type
	Straight socket, M8x1, 3-pin	Cable, open end, 3-wire	2.5	541333	NEBU-M8G3-K-2.5-LE3
			5	541334	NEBU-M8G3-K-5-LE3
	Angled socket, M8x1, 3-pin	Cable, open end, 3-wire	2.5	541338	NEBU-M8W3-K-2.5-LE3
			5	541341	NEBU-M8W3-K-5-LE3

Three-point grippers HGDD, sealed

Accessories

Proximity sensor for size 35						
Ordering data – Proximity sensors 3 mm (round design), inductive						Technical data → Internet: sieh
	Electrical connection	LED	Switching output	Cable length [m]	Part No.	Type
N/O contact						
	Cable, 3-wire	■	PNP	2.5	538264	SIEH-3B-PS-K-L
	Plug M8x1, 3-pin	■		–	538263	SIEH-3B-PS-S-L

Proximity sensor for size 40 ... 80						
Ordering data – Proximity sensors M8 (round design), inductive						Technical data → Internet: sien
	Electrical connection	LED	Switching output	Cable length [m]	Part No.	Type
N/O contact						
	Cable, 3-wire	■	PNP	2.5	150386	SIEN-M8B-PS-K-L
	Plug M8x1, 3-pin	■		–	150387	SIEN-M8B-PS-S-L

Ordering data – Connecting cables						Technical data → Internet: nebu
	Electrical connection, left	Electrical connection, right	Cable length [m]	Part No.	Type	
	Straight socket, M8x1, 3-pin	Cable, open end, 3-wire	2.5	541333	NEBU-M8G3-K-2.5-LE3	
			5	541334	NEBU-M8G3-K-5-LE3	
	Angled socket, M8x1, 3-pin	Cable, open end, 3-wire	2.5	541338	NEBU-M8W3-K-2.5-LE3	
			5	541341	NEBU-M8W3-K-5-LE3	