

Suction cup holders ESH

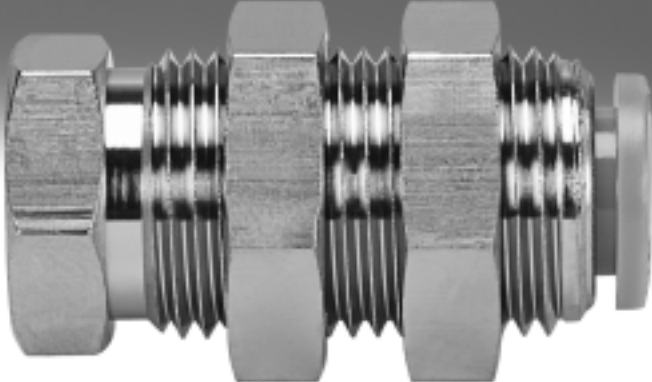

Suction cup holders ESH

Type codes

FESTO

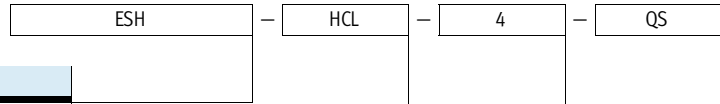

Type	
ESH	Suction cup holder

Suction cup holder	
HA	Vacuum port on top, mounting via lock nut, without height compensator
HB	Vacuum port on side, mounting via female thread, without height compensator
HC	Vacuum port on top, mounting via lock nut, with height compensator
HCL	Vacuum port on top, mounting via lock nut, with long height compensator
HD	Vacuum port on side, mounting via lock nut, with height compensator
HDL	Vacuum port on side, mounting via lock nut, with long height compensator
HE	Vacuum port on top, mounting via threaded connection for direct screw-in, without height compensator
HF	Vacuum port on top, mounting via threaded connection for direct screw-in, with height compensator

Classification of suction cup holders for suction cups ESS	
1	Size 1 for suction cup mounting \varnothing 3 mm
2	Size 2 for suction cup mounting \varnothing 4 mm
3	Size 3 for suction cup mounting M4
4	Size 4 for suction cup mounting M6
5	Size 5 for suction cup mounting M10
6	Size 6 for suction cup mounting M20x2

Vacuum port	
HA/HB/HC/HCL/HD/HDL	
QS	Push-in connector QS
PK	Barbed fitting connection PK
G	Threaded connection G
HE	
M3	Threaded connection M3
M5	Threaded connection M5
G $\frac{1}{8}$	Threaded connection G $\frac{1}{8}$
G $\frac{1}{4}$	Threaded connection G $\frac{1}{4}$
HF	
M10x1	Threaded connection M10x1
M14x1	Threaded connection M14x1

-  - Note
Possible combinations can be found in the ordering data.

Suction cup holders ESH-HA

Technical data

ESH-HA

Vacuum port on top, mounting via lock nut, without height compensator

Vacuum port:

- Push-in connector QS
- Barbed fitting connection PK
- Threaded connection G

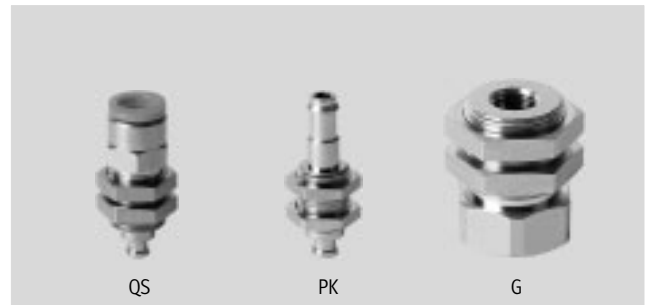

General technical data	
Design	Vacuum port on top
Type of mounting	Via lock nut
Mounting position	Vertical

Technical data					
Classification of suction cup holders for suction cups ESS → Internet: ESS	Vacuum port	Suction cup mounting	Nominal width	Volume	Weight
			[mm]	[cm ³]	[g]
Size 1	QS-4	I.D. 3 mm ¹⁾	3	0.239	6
	PK-3		2.5	0.090	3
Size 2	QS-6	O.D. 4 mm ¹⁾	2	0.501	12
	PK-4		2	0.169	7
Size 3	QS-6	M4	5	0.520	20
	PK-4		2.5	0.274	10
Size 4	QS-6	M6	5	0.719	30
	PK-4		2.5	0.668	23
Size 5	G ¹ / ₈	M10	8	1.862	84
Size 6	G ¹ / ₄	M20x2	10	7.234	200

1) Suction cup ESS is pushed in or on.

Operating and environmental conditions			
Vacuum port	Push-in connector QS	Barbed fitting connection PK	Threaded connection G
Operating medium	Atmospheric air based on ISO 8573-1:2010 [7:-:-]		
Ambient temperature [°C]	0 ... +60	-10 ... +60	-10 ... +60
Corrosion resistance class CRC ¹⁾	1		

1) Corrosion resistance class CRC 1 to Festo standard FN 940070
 Low corrosion stress. For dry indoor applications or transport and storage protection. Also applies to parts behind covers, in the non-visible interior area, and parts which are covered in the application (e.g. drive trunnions).

Materials			
Vacuum port	Push-in connector QS	Barbed fitting connection PK	Threaded connection G
Retainer	High-alloy steel, tempered steel, POM	High-alloy steel, tempered steel	High-alloy steel, tempered steel
Seals	NBR	Steel, NBR	-
Note on materials	RoHS-compliant		

Suction cup holders ESH-HA

Technical data

FESTO

Dimensions

Push-in connector QS

Size 1

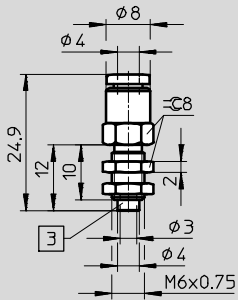

Size 2

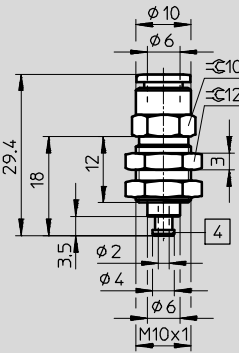

Size 3

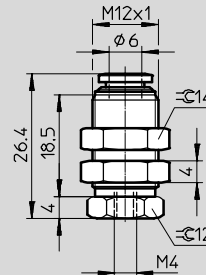

Size 4

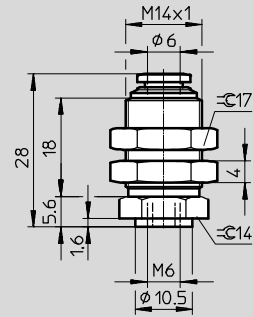

Barbed fitting connection PK

Size 1

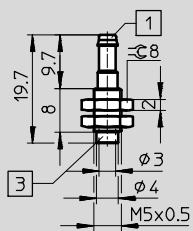

Size 2

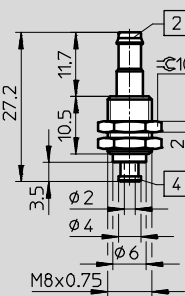

Size 3

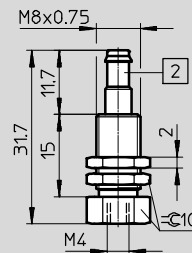

Size 4

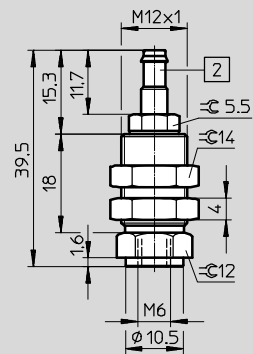

Threaded connection G

Size 5/size 6*

M20x1 (M24x2)

G1/8 (G1/4)

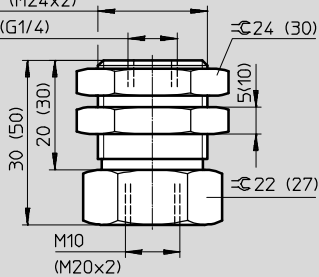

1 Barbed fitting PK-3 for plastic tubing

2 Barbed fitting PK-4 for plastic tubing

3 Hole for suction cup

4 Barbed fitting for suction cup tubing

* Dimensions in brackets

Suction cup holders ESH-HA

Technical data

Ordering data							
Classification of suction cup holders	Vacuum port	Push-in connector		Barbed fitting connection		Threaded connection	
		Part No.	Type	Part No.	Type	Part No.	Type
Size 1	QS-4	189193	ESH-HA-1-QS	–	–	–	–
	PK-3	–	–	189194	ESH-HA-1-PK	–	–
Size 2	QS-6	189195	ESH-HA-2-QS	–	–	–	–
	PK-4	–	–	189196	ESH-HA-2-PK	–	–
Size 3	QS-6	189197	ESH-HA-3-QS	–	–	–	–
	PK-4	–	–	189198	ESH-HA-3-PK	–	–
Size 4	QS-6	189199	ESH-HA-4-QS	–	–	–	–
	PK-4	–	–	189200	ESH-HA-4-PK	–	–
Size 5	G ¹ / ₈	–	–	–	–	189201	ESH-HA-5-G
Size 6	G ¹ / ₄	–	–	–	–	189202	ESH-HA-6-G

Suction cup holders ESH-HB

Technical data

FESTO

ESH-HB

Vacuum port on side, mounting via female thread, without height compensator

Vacuum port:

- Push-in connector QS
- Barbed fitting connection PK
- Threaded connection G



General technical data	
Design	Vacuum port on side
Type of mounting	Via female thread
Mounting position	Vertical

Technical data					
Classification of suction cup holders for suction cups ESS → Internet: ESS	Vacuum port	Suction cup mounting	Nominal width	Volume	Weight
			[mm]	[cm ³]	[g]
Size 1	QS-4	I.D. 3 mm ¹⁾	3	0.228	5
	PK-3		2.5	0.108	4
Size 2	QS-6	O.D. 4 mm ¹⁾	2	0.418	13
	PK-4		2	0.188	11
Size 3	QS-6	M4	3.3	0.539	29
	PK-4		2.5	0.313	27
Size 4	QS-6	M6	5	0.646	27
	PK-4		2.5	0.416	25
Size 5	G ¹ / ₈	M10	8.5	1.921	91
Size 6	G ¹ / ₄	M20x2	10	7.25	271

1) Suction cup ESS is pushed in or on.

Operating and environmental conditions			
Vacuum port	Push-in connector QS	Barbed fitting connection PK	Threaded connection G
Operating medium	Atmospheric air based on ISO 8573-1:2010 [7:--:-]		
Ambient temperature [°C]	0 ... +60	-10 ... +60	-10 ... +60
Corrosion resistance class CRC ¹⁾	1		

1) Corrosion resistance class CRC 1 to Festo standard FN 940070

Low corrosion stress. For dry indoor applications or transport and storage protection. Also applies to parts behind covers, in the non-visible interior area, and parts which are covered in the application (e.g. drive trunnions).

Materials			
Vacuum port	Push-in connector QS	Barbed fitting connection PK	Threaded connection G
Retainer	High-alloy steel, tempered steel, POM	High-alloy steel, tempered steel	High-alloy steel, tempered steel
Seals	Steel, NBR	Steel, NBR	-
Note on materials	RoHS-compliant		

Suction cup holders ESH-HB

Technical data



Dimensions

Push-in connector QS

Size 1

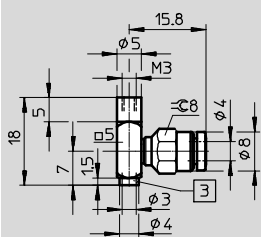

Size 2

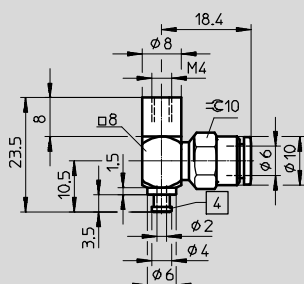

Size 3

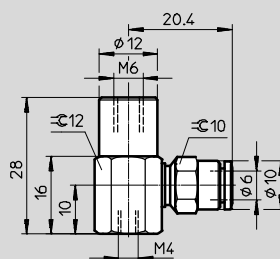

Size 4

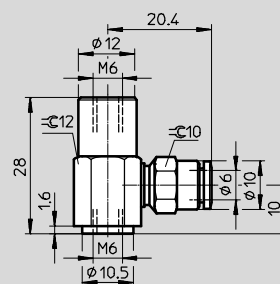

Barbed fitting connection PK

Size 1

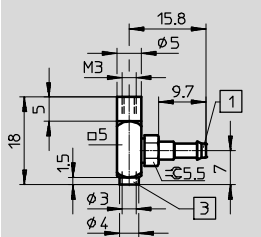

Size 2

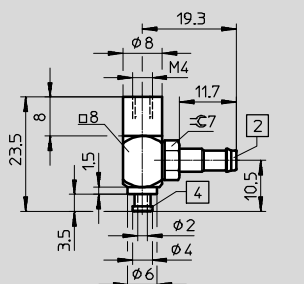

Size 3

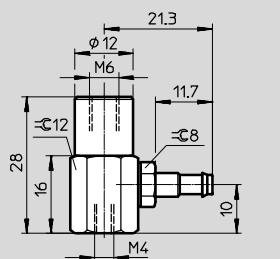

Size 4

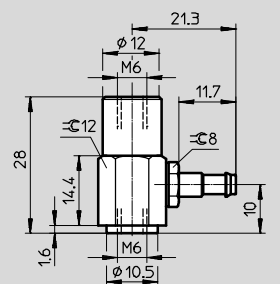

Threaded connection G

Size 5/size 6*

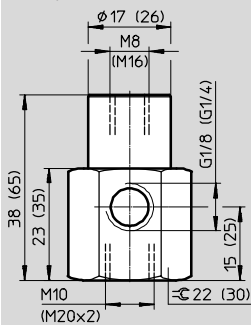

1 Barbed fitting PK-3 for plastic tubing

2 Barbed fitting PK-4 for plastic tubing

3 Hole for suction cup

4 Barbed fitting for suction cup

* Dimensions in brackets

Suction cup holders ESH-HB

Technical data

Ordering data							
Classification of suction cup holders	Vacuum port	Push-in connector		Barbed fitting connection		Threaded connection	
		Part No.	Type	Part No.	Type	Part No.	Type
Size 1	QS-4	189203	ESH-HB-1-QS	–	–	–	–
	PK-3	–	–	189204	ESH-HB-1-PK	–	–
Size 2	QS-6	189205	ESH-HB-2-QS	–	–	–	–
	PK-4	–	–	189206	ESH-HB-2-PK	–	–
Size 3	QS-6	189207	ESH-HB-3-QS	–	–	–	–
	PK-4	–	–	189208	ESH-HB-3-PK	–	–
Size 4	QS-6	189209	ESH-HB-4-QS	–	–	–	–
	PK-4	–	–	189210	ESH-HB-4-PK	–	–
Size 5	G $\frac{1}{8}$	–	–	–	–	189211	ESH-HB-5-G
Size 6	G $\frac{1}{4}$	–	–	–	–	189212	ESH-HB-6-G

Suction cup holders ESH-HC

Technical data

ESH-HC

Vacuum port on top, mounting via lock nut, with height compensator

Vacuum port:

- Push-in connector QS
- Barbed fitting connection PK
- Threaded connection G

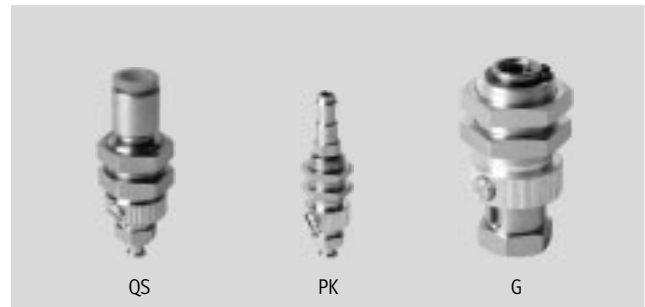

General technical data	
Design	Vacuum port on top, with height compensator
Type of mounting	Via lock nut
Mounting position	Vertical

Technical data							
Classification of suction cup holders for suction cups ESS → Internet: ESS	Vacuum port	Suction cup mounting	Nominal width [mm]	Suction cup holder height compensator [mm]	Spring force (normal/min. length) [N]	Volume [cm ³]	Weight [g]
	PK-3		1.2			0.117	8
Size 2	QS-6	O.D. 4 mm ¹⁾	2.2	3	Max. 1	0.551	18
	PK-4		1.2			0.192	8
Size 3	QS-6	M4	3.4	6	2/5	1.041	34
	PK-4		2.5			0.789	32
Size 4	QS-6	M6	3.4	6	5/10	1.153	33
	PK-4		2.5			0.911	31
Size 5	G ¹ / ₈	M10	8.4	10	8/18	3.327	112
Size 6	G ¹ / ₄	M20x2	10	20	12/22	11.537	472

1) Suction cup ESS is pushed in or on.

Operating and environmental conditions			
Vacuum port	Push-in connector QS	Barbed fitting connection PK	Threaded connection G
Operating medium	Atmospheric air based on ISO 8573-1:2010 [7:-:-]		
Ambient temperature [°C]	0 ... +60	-10 ... +60	-10 ... +60
Corrosion resistance class CRC ¹⁾	1		

1) Corrosion resistance class CRC 1 to Festo standard FN 940070
 Low corrosion stress. For dry indoor applications or transport and storage protection. Also applies to parts behind covers, in the non-visible interior area, and parts which are covered in the application (e.g. drive trunnions).

Materials			
Vacuum port	Push-in connector QS	Barbed fitting connection PK	Threaded connection G
Retainer	High-alloy steel, tempered steel, POM	High-alloy steel, tempered steel	High-alloy steel, tempered steel
Seals	Steel, NBR	Steel, NBR	-
Note on materials	RoHS-compliant		

Suction cup holders ESH-HC

Technical data

Dimensions

Push-in connector QS

Size 1

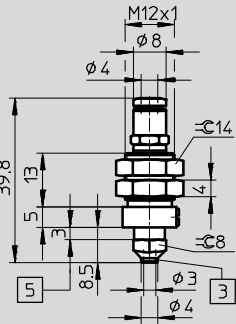

Size 2

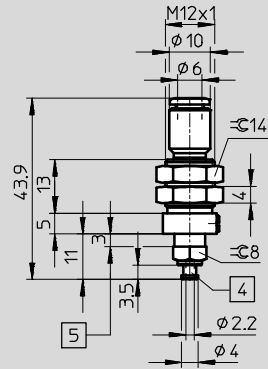

Size 3/size 4*

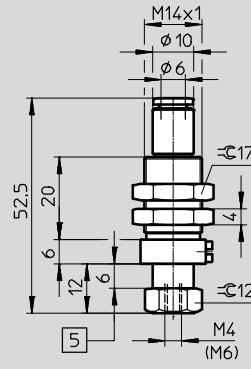

Barbed fitting connection PK

Size 1

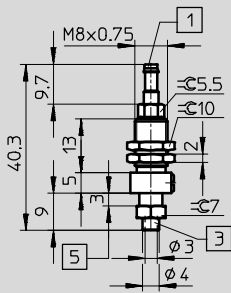

Size 2

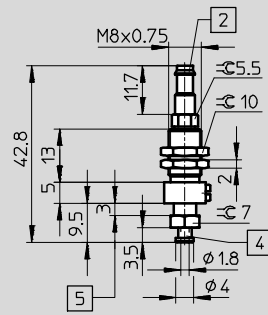

Size 3/size 4*

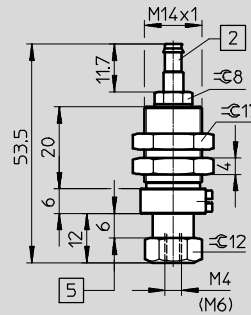

Threaded connection G

Size 5

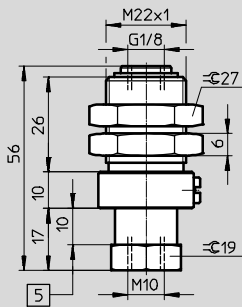

Size 6

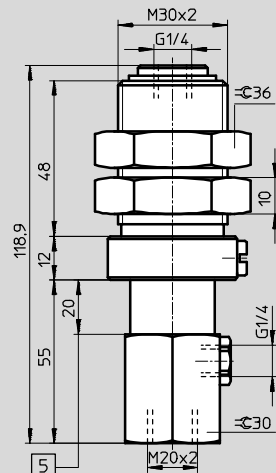

1 Barbed fitting PK-3 for plastic tubing

2 Barbed fitting PK-4 for plastic tubing

3 Hole for suction cup

4 Barbed fitting for suction cup

5 Stroke

* Dimensions in brackets

Suction cup holders ESH-HC

Technical data

Ordering data							
Classification of suction cup holders	Vacuum port	Push-in connector		Barbed fitting connection		Threaded connection	
		Part No.	Type	Part No.	Type	Part No.	Type
Size 1	QS-4	189213	ESH-HC-1-QS	–	–	–	–
	PK-3	–	–	189214	ESH-HC-1-PK	–	–
Size 2	QS-6	189215	ESH-HC-2-QS	–	–	–	–
	PK-4	–	–	189216	ESH-HC-2-PK	–	–
Size 3	QS-6	189217	ESH-HC-3-QS	–	–	–	–
	PK-4	–	–	189218	ESH-HC-3-PK	–	–
Size 4	QS-6	189219	ESH-HC-4-QS	–	–	–	–
	PK-4	–	–	189220	ESH-HC-4-PK	–	–
Size 5	G ¹ / ₈	–	–	–	–	189221	ESH-HC-5-G
Size 6	G ¹ / ₄	–	–	–	–	189222	ESH-HC-6-G

Suction cup holders ESH-HCL

Technical data

FESTO

ESH-HCL

Vacuum port on top, mounting via lock nut, with long height compensator

Vacuum port:

- Push-in connector QS
- Barbed fitting connection PK
- Threaded connection G



General technical data	
Design	Vacuum port on top, with height compensator
Type of mounting	Via lock nut
Mounting position	Vertical

Technical data							
Classification of suction cup holders for suction cups ESS → Internet: ESS	Vacuum port	Suction cup mounting	Nominal width [mm]	Suction cup holder height compensator [mm]	Spring force (normal/min. length) [N]	Volume [cm ³]	Weight [g]
Size 1	QS-4	I.D. 3 mm ¹⁾	2.8	10	Max. 1	0.489	20
	PK-3		1.9			0.360	19
Size 2	QS-6	O.D. 4 mm ¹⁾	2.2	10	Max. 1	0.519	20
	PK-4		2.2			0.398	19
Size 3	QS-6	M4	3.4	20	1/3	1.616	48
	PK-4		3			1.383	46
Size 4	QS-6	M6	3.4	20	1/9	1.780	47
	PK-4		3			1.535	45
Size 5	G $\frac{1}{8}$	M10	8.4	30	10/16	6.060	169
Size 6	G $\frac{1}{4}$	M20x2	10	40	15/32	16.325	560

1) Suction cup ESS is pushed in or on.

Operating and environmental conditions			
Vacuum port	Push-in connector QS	Barbed fitting connection PK	Threaded connection G
Operating medium	Atmospheric air based on ISO 8573-1:2010 [7:-:-]		
Ambient temperature [°C]	0 ... +60	-10 ... +60	-10 ... +60
Corrosion resistance class CRC ¹⁾	1		

1) Corrosion resistance class CRC 1 to Festo standard FN 940070

Low corrosion stress. For dry indoor applications or transport and storage protection. Also applies to parts behind covers, in the non-visible interior area, and parts which are covered in the application (e.g. drive trunnions).

Materials			
Vacuum port	Push-in connector QS	Barbed fitting connection PK	Threaded connection G
Retainer	High-alloy steel, tempered steel, POM	High-alloy steel, tempered steel	High-alloy steel, tempered steel
Seals	Steel, NBR	Steel, NBR	-
Note on materials	RoHS-compliant		

Suction cup holders ESH-HCL

Technical data

Dimensions

Push-in connector QS

Size 1

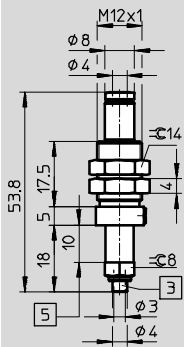

Size 2

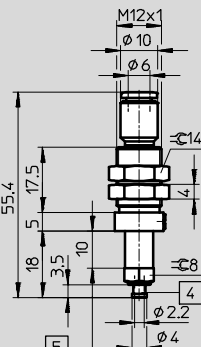

Size 3/size 4*

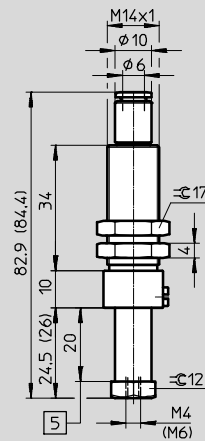

Barbed fitting connection PK

Size 1

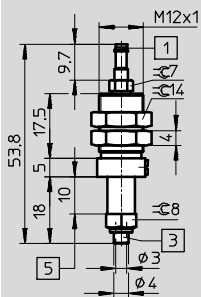

Size 2

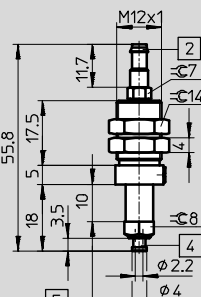

Size 3/size 4*

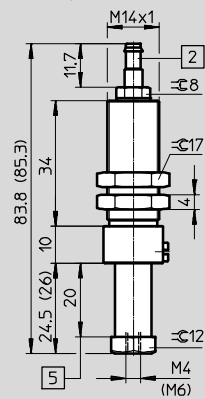

Threaded connection G

Size 5

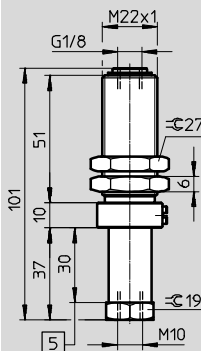

Size 6

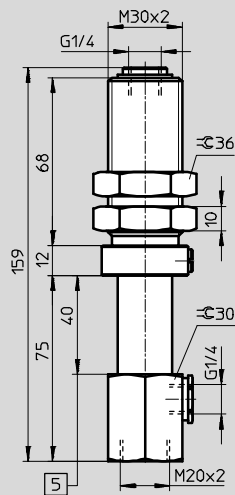

- 1) Barbed fitting PK-3 for plastic tubing
- 2) Barbed fitting PK-4 for plastic tubing
- 3) Hole for suction cup
- 4) Barbed fitting for suction cup
- 5) Stroke

1) Dimensions in brackets

Suction cup holders ESH-HCL

Technical data

Ordering data							
Classification of suction cup holders	Vacuum port	Push-in connector		Barbed fitting connection		Threaded connection	
		Part No.	Type	Part No.	Type	Part No.	Type
Size 1	QS-4	189223	ESH-HCL-1-QS	–	–	–	–
	PK-3	–	–	189224	ESH-HCL-1-PK	–	–
Size 2	QS-6	189225	ESH-HCL-2-QS	–	–	–	–
	PK-4	–	–	189226	ESH-HCL-2-PK	–	–
Size 3	QS-6	189227	ESH-HCL-3-QS	–	–	–	–
	PK-4	–	–	189228	ESH-HCL-3-PK	–	–
Size 4	QS-6	189229	ESH-HCL-4-QS	–	–	–	–
	PK-4	–	–	189230	ESH-HCL-4-PK	–	–
Size 5	G $\frac{1}{8}$	–	–	–	–	189231	ESH-HCL-5-G
Size 6	G $\frac{1}{4}$	–	–	–	–	189232	ESH-HCL-6-G

Suction cup holders ESH-HD

Technical data

ESH-HD

Vacuum port on side, mounting via lock nut, with height compensator

Vacuum port:

- Push-in connector QS
- Barbed fitting connection PK
- Threaded connection G

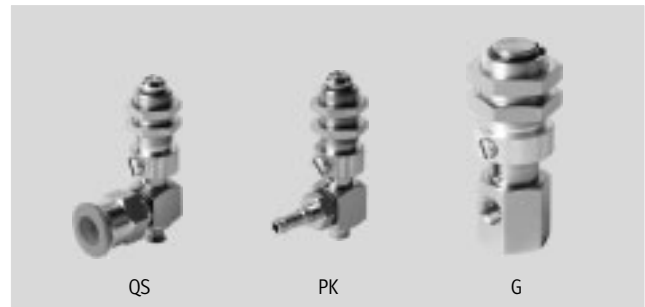

General technical data	
Design	Vacuum port on side, with height compensator
Type of mounting	Via lock nut
Mounting position	Vertical

Technical data							
Classification of suction cup holders for suction cups ESS → Internet: ESS	Vacuum port	Suction cup mounting	Nominal width [mm]	Suction cup holder height compensator [mm]	Spring force (normal/min. length) [N]	Volume [cm ³]	Weight [g]
	PK-3		1.9			0.120	11
Size 2	QS-6	O.D. 4 mm ¹⁾	1.8	3	Max. 1	0.417	15
	PK-4		1.8			0.183	12
Size 3	QS-6	M4	3.3	6	2/5	0.573	46
	PK-4		3			0.343	44
Size 4	QS-6	M6	5	6	5/10	0.678	45
	PK-4		3			0.449	43
Size 5	G ¹ / ₈	M10	8.5	10	8/18	2.072	195
Size 6	G ¹ / ₄	M20x2	10	20	12/22	13.171	472

1) Suction cup ESS is pushed in or on.

Operating and environmental conditions			
Vacuum port	Push-in connector QS	Barbed fitting connection PK	Threaded connection G
Operating medium	Atmospheric air based on ISO 8573-1:2010 [7:-:-]		
Ambient temperature [°C]	0 ... +60	-10 ... +60	-10 ... +60
Corrosion resistance class CRC ¹⁾	1		

1) Corrosion resistance class CRC 1 to Festo standard FN 940070
 Low corrosion stress. For dry indoor applications or transport and storage protection. Also applies to parts behind covers, in the non-visible interior area, and parts which are covered in the application (e.g. drive trunnions).

Materials			
Vacuum port	Push-in connector QS	Barbed fitting connection PK	Threaded connection G
Retainer	High-alloy steel, tempered steel, POM	High-alloy steel, tempered steel	High-alloy steel, tempered steel
Seals	Steel, NBR	Steel, NBR	-
Note on materials	RoHS-compliant		

Suction cup holders ESH-HD

Technical data

Dimensions

Push-in connector QS

Size 1

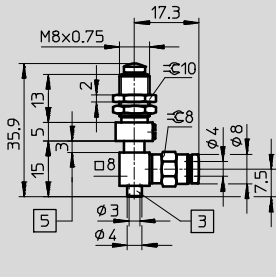

Size 2

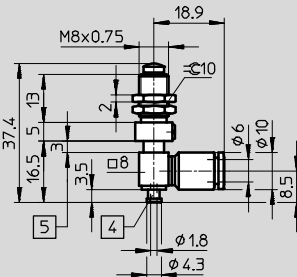

Size 3/size 4*

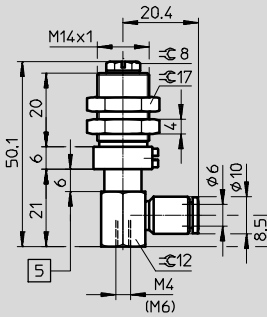

Barbed fitting connection PK

Size 1

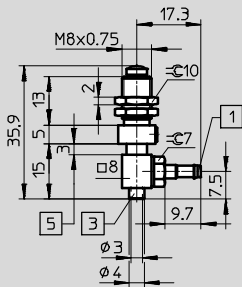

Size 2

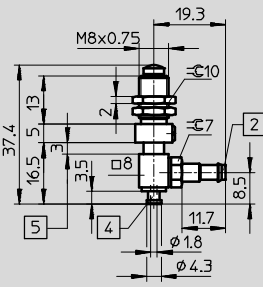

Size 3/size 4*

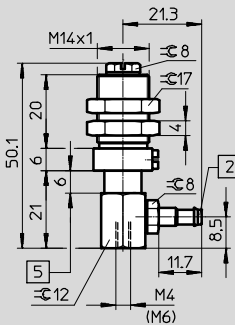

Threaded connection G

Size 5

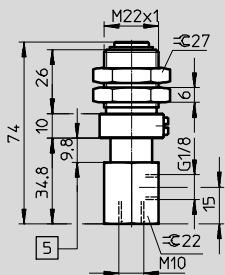

Size 6

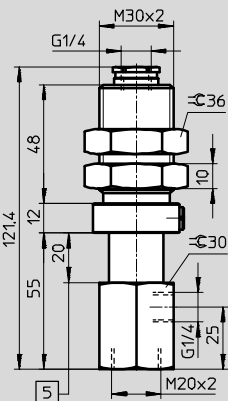

1 Barbed fitting PK-3 for plastic tubing

2 Barbed fitting PK-4 for plastic tubing

3 Hole for suction cup

4 Barbed fitting for suction cup

5 Stroke

* Dimensions in brackets

Suction cup holders ESH-HD

Technical data

Ordering data							
Classification of suction cup holders	Vacuum port	Push-in connector		Barbed fitting connection		Threaded connection	
		Part No.	Type	Part No.	Type	Part No.	Type
Size 1	QS-4	189233	ESH-HD-1-QS	–	–	–	–
	PK-3	–	–	189234	ESH-HD-1-PK	–	–
Size 2	QS-6	189235	ESH-HD-2-QS	–	–	–	–
	PK-4	–	–	189236	ESH-HD-2-PK	–	–
Size 3	QS-6	189237	ESH-HD-3-QS	–	–	–	–
	PK-4	–	–	189238	ESH-HD-3-PK	–	–
Size 4	QS-6	189239	ESH-HD-4-QS	–	–	–	–
	PK-4	–	–	189240	ESH-HD-4-PK	–	–
Size 5	G ¹ / ₈	–	–	–	–	189241	ESH-HD-5-G
Size 6	G ¹ / ₄	–	–	–	–	189242	ESH-HD-6-G

Suction cup holders ESH-HDL

Technical data

FESTO

ESH-HDL

Vacuum port on side, mounting via lock nut, with long height compensator

Vacuum port:

- Push-in connector QS
- Barbed fitting connection PK
- Threaded connection G

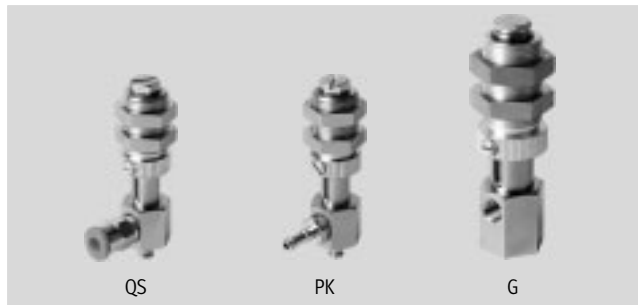

General technical data	
Design	Vacuum port on side, with height compensator
Type of mounting	Via lock nut
Mounting position	Vertical

Technical data							
Classification of suction cup holders for suction cups ESS → Internet: ESS	Vacuum port	Suction cup mounting	Nominal width [mm]	Suction cup holder height compensator [mm]	Spring force (normal/min. length) [N]	Volume [cm ³]	Weight [g]
Size 1	QS-4	I.D. 3 mm ¹⁾	3	10	Max. 1	0.272	29
	PK-3		1.9			0.150	28
Size 2	QS-6	O.D. 4 mm ¹⁾	2.2	10	Max. 1	0.260	33
	PK-4		2.2			0.138	32
Size 3	QS-6	M4	3.3	20	1/3	0.474	65
	PK-4		3			0.252	63
Size 4	QS-6	M6	5	20	1/9	0.370	65
	PK-4		3			0.448	63
Size 5	G $\frac{1}{8}$	M10	8.5	30	10/16	1.667	273
Size 6	G $\frac{1}{4}$	M20x2	10	40	15/32	16.968	560

1) Suction cup ESS is pushed in or on.

Operating and environmental conditions			
Vacuum port	Push-in connector QS	Barbed fitting connection PK	Threaded connection G
Operating medium	Atmospheric air based on ISO 8573-1:2010 [7:-:-]		
Ambient temperature [°C]	0 ... +60	-10 ... +60	-10 ... +60
Corrosion resistance class CRC ¹⁾	1		

1) Corrosion resistance class CRC 1 to Festo standard FN 940070

Low corrosion stress. For dry indoor applications or transport and storage protection. Also applies to parts behind covers, in the non-visible interior area, and parts which are covered in the application (e.g. drive trunnions).

Materials			
Vacuum port	Push-in connector QS	Barbed fitting connection PK	Threaded connection G
Retainer	High-alloy steel, tempered steel, POM	High-alloy steel, tempered steel	High-alloy steel, tempered steel
Seals	Steel, NBR	Steel, NBR	-
Note on materials	RoHS-compliant		

Suction cup holders ESH-HDL

Technical data

Dimensions

Push-in connector QS

Size 1

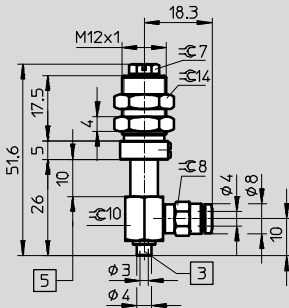

Size 2

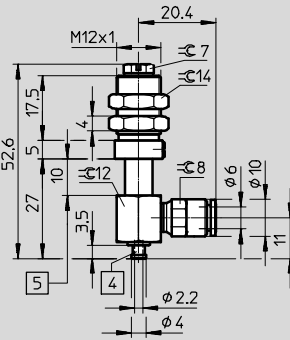

Size 3/size 4*

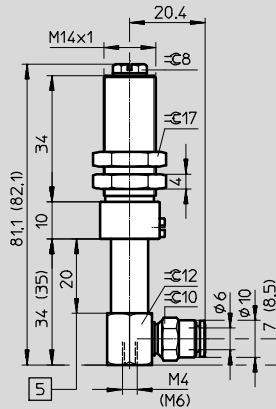

Barbed fitting connection PK

Size 1

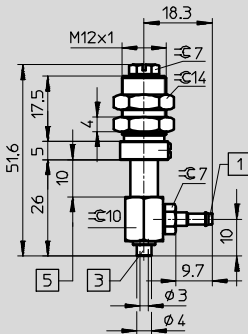

Size 2

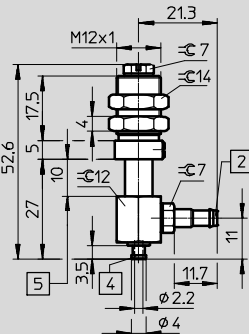

Size 3/size 4*

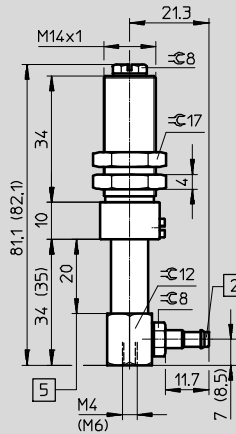

Threaded connection G

Size 5

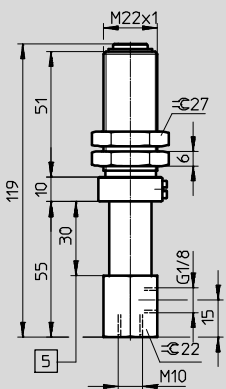

Size 6

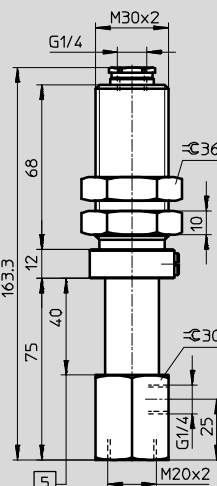

- 1 Barbed fitting PK-3 for plastic tubing
- 2 Barbed fitting PK-4 for plastic tubing
- 3 Hole for suction cup
- 4 Barbed fitting for suction cup
- 5 Stroke

* Dimensions in brackets

Suction cup holders ESH-HDL

Technical data

Ordering data							
Classification of suction cup holders	Vacuum port	Push-in connector		Barbed fitting connection		Threaded connection	
		Part No.	Type	Part No.	Type	Part No.	Type
Size 1	QS-4	189243	ESH-HDL-1-QS	–	–	–	–
	PK-3	–	–	189244	ESH-HDL-1-PK	–	–
Size 2	QS-6	189245	ESH-HDL-2-QS	–	–	–	–
	PK-4	–	–	189246	ESH-HDL-2-PK	–	–
Size 3	QS-6	189247	ESH-HDL-3-QS	–	–	–	–
	PK-4	–	–	189248	ESH-HDL-3-PK	–	–
Size 4	QS-6	189249	ESH-HDL-4-QS	–	–	–	–
	PK-4	–	–	189250	ESH-HDL-4-PK	–	–
Size 5	G $\frac{1}{8}$	–	–	–	–	189251	ESH-HDL-5-G
Size 6	G $\frac{1}{4}$	–	–	–	–	189252	ESH-HDL-6-G

Suction cup holders ESH-HE

Technical data

ESH-HE

Vacuum port on top, mounting via threaded connection for direct screw-in, without height compensator

Vacuum port:

- Threaded connection M3 and M5
- Threaded connection G $\frac{1}{8}$ and G $\frac{1}{4}$

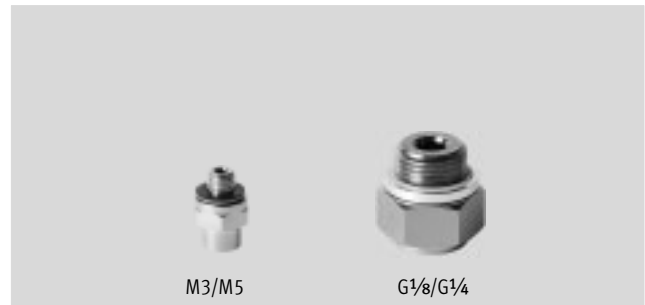

General technical data	
Design	Vacuum port on top
Type of mounting	Via male thread, via vacuum port
Mounting position	Vertical

Technical data					
Classification of suction cup holders for suction cups ESS → Internet: ESS	Vacuum port	Suction cup mounting	Nominal width	Volume	Weight
			[mm]	[cm ³]	[g]
Size 1	M3	I.D. 3 mm ¹⁾	1.2	0.040	1
Size 2	M5	O.D. 4 mm ¹⁾	2	0.036	3
Size 3	G $\frac{1}{8}$	M4	3	0.106	11
Size 4	G $\frac{1}{8}$	M6	4	0.289	11
Size 5	G $\frac{1}{4}$	M10	7	1.227	24

1) Suction cup ESS is pushed in or on.

Operating and environmental conditions	
Operating medium	Atmospheric air based on ISO 8573-1:2010 [7:-:-]
Ambient temperature [°C]	-10 ... +60
Corrosion resistance class CRC ¹⁾	1

1) Corrosion resistance class CRC 1 to Festo standard FN 940070
Low corrosion stress. For dry indoor applications or transport and storage protection. Also applies to parts behind covers, in the non-visible interior area, and parts which are covered in the application (e.g. drive trunnions).

Materials	
Retainer	Tempered steel
Seals	Steel, NBR, wrought aluminium alloy, POM
Note on materials	RoHS-compliant

Suction cup holders ESH-HE

Technical data

Dimensions

G and M thread

Size 1

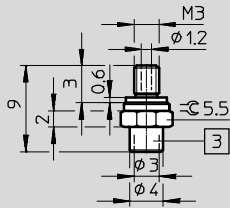

Size 2

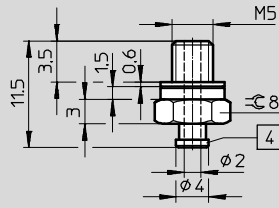

Size 3

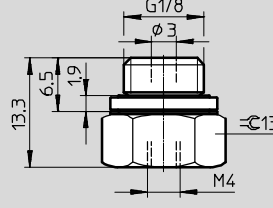

Size 4

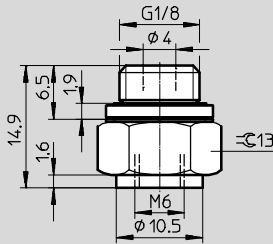

Size 5

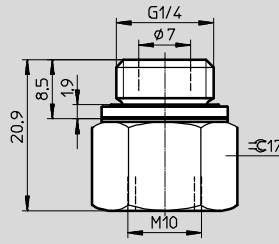

3 Hole for suction cup

4 Barbed fitting for suction cup

Ordering data

Classification of suction cup holders	Vacuum port	Part No.	Type
Size 1	M3	189253	ESH-HE-1-M3
Size 2	M5	189254	ESH-HE-2-M5
Size 3	G1/8	189255	ESH-HE-3-G1/8
Size 4	G1/8	189256	ESH-HE-4-G1/8
Size 5	G1/4	189257	ESH-HE-5-G1/4

Suction cup holders ESH-HF

Technical data

ESH-HF

Vacuum port on top, mounting via threaded connection for direct screw-in, with height compensator

Vacuum port:

- Threaded connection M10x1 and M14x1



General technical data	
Design	Vacuum port on top, with height compensator
Type of mounting	Via male thread, via vacuum port
Mounting position	Vertical

Technical data							
Classification of suction cup holders for suction cups ESS → Internet: ESS	Vacuum port	Suction cup mounting	Nominal width [mm]	Suction cup holder height compensator [mm]	Spring force (normal/min. length) [N]	Volume [cm ³]	Weight [g]
Size 1	M10x1	I.D. 3 mm ¹⁾	2	2.6	2/4	0.108	14
Size 2	M10x1	O.D. 4 mm ¹⁾	2			0.090	14
Size 3	M14x1	M4	3.3	6	6/12	0.400	54
Size 4	M14x1	M6	4			0.655	52

1) Suction cup ESS is pushed in or on.

Operating and environmental conditions	
Operating medium	Atmospheric air based on ISO 8573-1:2010 [7:-:-]
Ambient temperature [°C]	-10 ... +60
Corrosion resistance class CRC ¹⁾	1

1) Corrosion resistance class CRC 1 to Festo standard FN 940070
Low corrosion stress. For dry indoor applications or transport and storage protection. Also applies to parts behind covers, in the non-visible interior area, and parts which are covered in the application (e.g. drive trunnions).

Materials	
Retainer	Tempered steel
Seals	NBR, POM
Note on materials	RoHS-compliant

Suction cup holders ESH-HF

Technical data

FESTO

Dimensions

M thread

Size 1

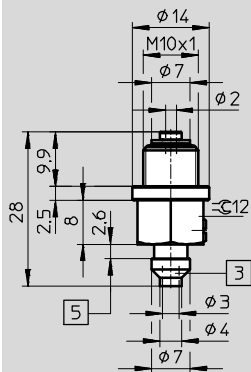

Size 2

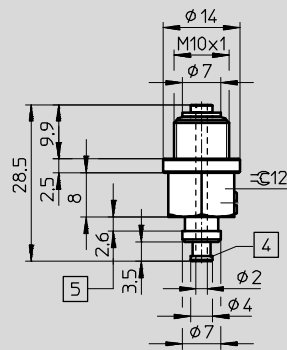

Size 3

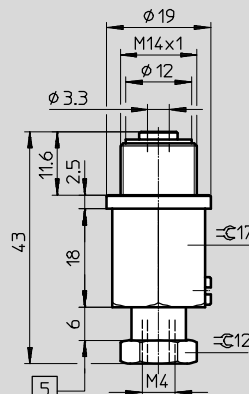

Size 4

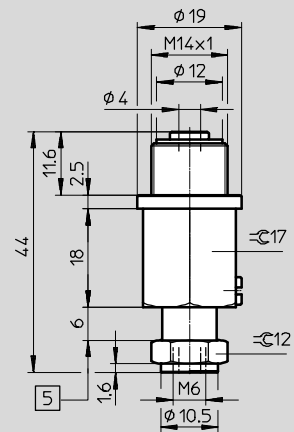

3 Hole for suction cup

4 Barbed fitting for suction cup

5 Stroke

Ordering data

Classification of suction cup holders	Vacuum port	Part No.	Type
Size 1	M10x1	189260	ESH-HF-1-M10x1
Size 2	M10x1	189261	ESH-HF-2-M10x1
Size 3	M14x1	189262	ESH-HF-3-M14x1
Size 4	M14x1	189263	ESH-HF-4-M14x1