

Electric cylinders ESBF, with spindle drive



 **New**
Sizes: 32, 40, 50

Electric cylinders ESBF, with spindle drive

Key features

FESTO

At a glance

The electric cylinder ESBF is a mechanical linear drive unit with piston rod. The driving component consists of an electrically actuated spindle that converts the rotary motion of the motor into a linear motion of the piston rod.

The electric cylinder is based on the ISO 15552 standard. The mechanical interfaces are largely compatible with the standards-based cylinder DSBF.

Two spindle types to choose from:

Size 32 ... 50:

- Ball screw (BS)
- Lead screw (LS)

Size 63 ... 100:

- Ball screw (BS)

Options:

- High corrosion protection
- Degree of protection IP65
- Piston rod extension
- NSF-H1 lubricant for food & beverage applications
- Wide range of accessories

Complete system consisting of electric cylinder, motor and motor mounting kit

Electric cylinder

→ 4



Motor

→ 25



 **Note**

A range of specially adapted complete solutions is available for the electric cylinder ESBF and the motors.

Motor mounting kit

→ 25

Axial kit

Parallel kit



Complete kits are available for both parallel and axial motor mounting.

Protective bellows kit EADB for use in dusty environments

→ 38



The protective bellows kit is a leak-free system. To prevent unwanted media from being drawn in, the supply and exhaust air for the kit must be ducted via a pressure compensation hole in the connection part **1**. The kit protects the piston rod, seal

and bearings against a wide variety of media, for example:

- Dust
- Chippings
- Oil
- Grease
- Petrol

Electric cylinders ESBF, with spindle drive

Features and type codes

Degree of protection IP65 (feature S1) for use in wet environments

→ 24

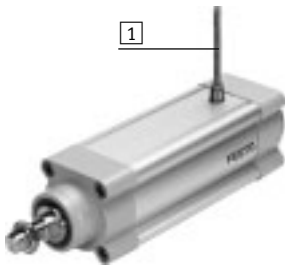

The electric cylinder to IP65 fulfils the specifications to IEC 60 529.

Air is exchanged between the interior of the cylinder and the environment via a pressure compensation hole **1**.

This prevents negative pressure or excess pressure arising in the interior of the cylinder.

It also prevents unwanted media being drawn in.

Sealing air can also be applied to the pressure compensation hole if needed (e.g. during a cleaning process).

NSF-H1 lubricant for food & beverage applications (feature F1)

The electric cylinder is of limited suitability for the food industry.

Can only be selected in combination with the ball screw (BS) drive system.

NSF-H1 lubricant for piston rod, screw spindle and other parts.

Further information on materials
www.festo.com/sp → technical hotline

Type codes

ESBF – BS – 63 – 100 – 5P – F

Type

ESBF	Electric cylinder
------	-------------------

Drive system

BS	Ball screw
LS	Lead screw

Size

Stroke [mm]

Spindle pitch [mm]

Variant

F	Female thread
S1	Degree of protection IP65
R3	High corrosion protection
F1	Suitable for use in the food industry as per extended information on materials
...E	Piston rod extension

New
Sizes: 32, 40, 50

Electric cylinders ESBF, with spindle drive

Peripherals overview

FESTO

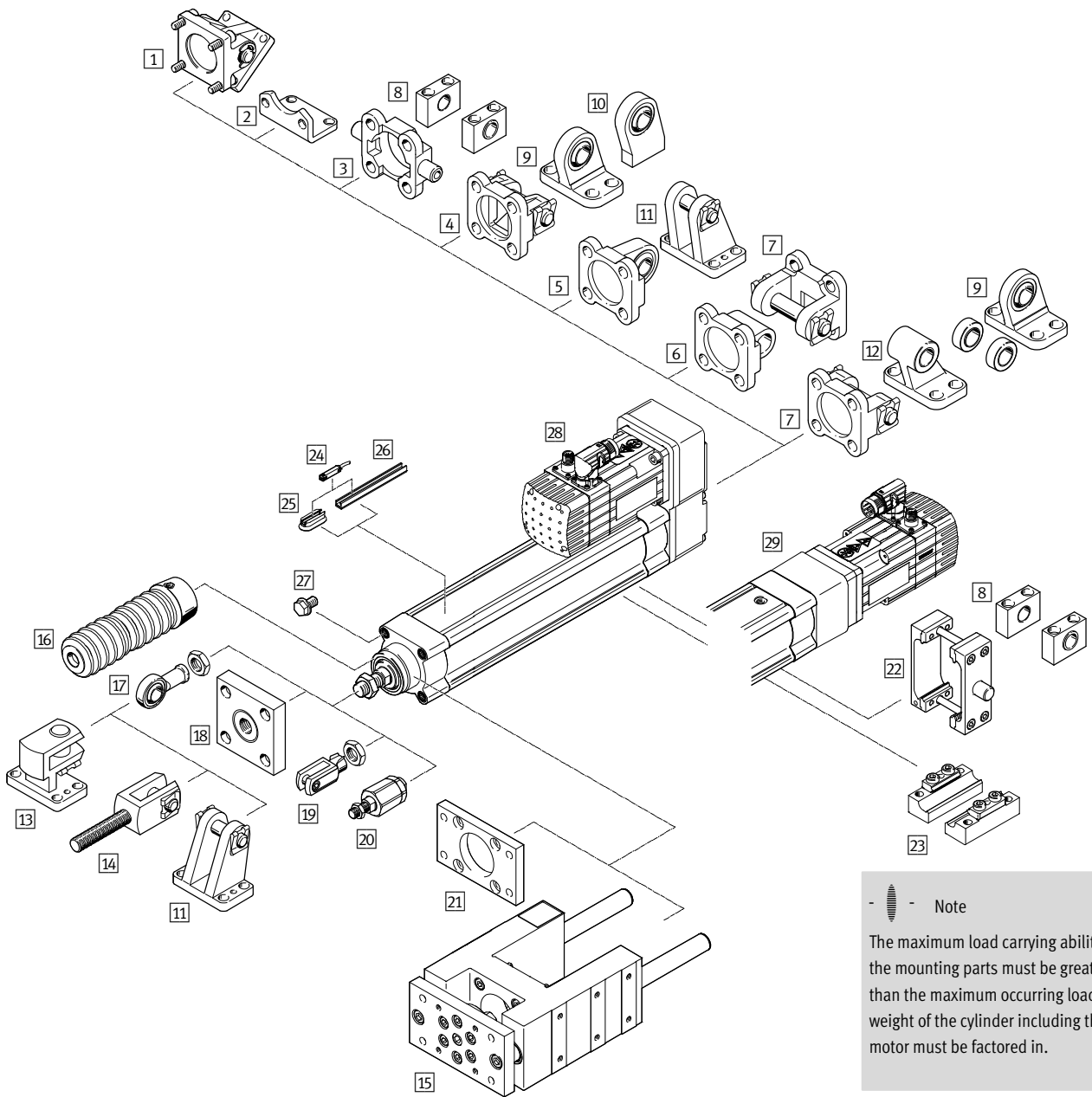

Note
 The maximum load carrying ability of the mounting parts must be greater than the maximum occurring load. The weight of the cylinder including the motor must be factored in.

Mounting components and accessories			
	Description	Suitable for high forces ¹⁾	→ Page/Internet
1	Swivel flange DAMS	■	49
2	Foot mounting HNC/CRHNC	–	44
3	Trunnion flange ZNCf/CRZNG	–	46
4	Swivel flange SNC	–	50
5	Swivel flange SNCS	–	51

1) Shows which accessories can be used within the entire force range. For restricted force ranges see the relevant accessory part, from page 44.

Electric cylinders ESBF, with spindle drive

Peripherals overview

Mounting components and accessories			
	Description	Suitable for high forces ¹⁾	→ Page/Internet
6	Swivel flange SNCL	With parallel motor mounting -	52
7	Swivel flange SNCB/SNCB-...-R3	With parallel motor mounting, for spherical bearing -	53
8	Trunnion support LNZG/CRLNZG	For cylinders with trunnion mounting -	47
9	Clevis foot LSNG	With parallel motor mounting, with spherical bearing -	55
10	Clevis foot LSNSG	With parallel motor mounting, weld-on, with spherical bearing -	55
11	Clevis foot LBG	With parallel motor mounting, for spherical bearing -	55
12	Clevis foot LNG/CRLNG	With parallel motor mounting -	55
13	Right-angle clevis foot LQG	For rod eye SGS -	55
14	Rod clevis SGA	For swivel mounting of cylinders ■	56
15	Guide unit EAGF	- For protecting electric cylinders against rotation at high torque loads - Cannot be used in combination with protective bellows kit EADB ■	57
16	Protective bellows kit EADB	- Protects the cylinder (piston rod, seal and bearings) against a wide range of media and thus prevents premature wear - The kit can only be used in combination with an extended piston rod (...E) ■	38
17	Rod eye SGS/CRSGS	With spherical bearing ■	56
18	Coupling piece KSZ	To compensate for radial deviations -	56
19	Rod clevis SG/CRSG	Permits a swivel motion of the cylinder in one plane ■	56
20	Self-aligning rod coupler FK/CRFK	For compensating radial and angular misalignments -	56
21	Flange mounting EAHH	- On the bearing cap - Cannot be used in combination with protective bellows kit EADB ■	45
22	Trunnion mounting kit DAMT	For mounting anywhere along the cylinder profile barrel. Cannot be mounted in the vicinity of the motor with parallel motor mounting -	54
23	Profile mounting EAHF-...-P	- For mounting the electric cylinder via the profile - Cannot be mounted in combination with the parallel kit EAMM-U with some combinations (in the vicinity of the motor) ■	43
24	Proximity sensor SME/SMT-8	For position sensing ■	58
25	Mounting kit CRSMB	For proximity sensor with T-slot ■	58
26	Sensor rail SAMH	For proximity sensor with T-slot ■	58
27	Blanking screw DAMD-PS	For covering unused mounting threads ■	59
28	Parallel kit EAMM-U	For parallel motor mounting ■	34
29	Axial kit EAMM-A	For axial motor mounting ■	25

1) Shows which accessories can be used within the entire force range. For restricted force ranges see the relevant accessory part, from page 44.

New
Sizes: 32, 40, 50



Electric cylinders ESBF, with spindle drive

Technical data

FESTO

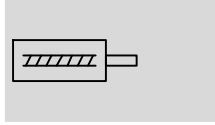
Function



-  Size
32 ... 100
-  Stroke length
30 ... 1500 mm
-  www.festo.com



General technical data						
Size	32	40	50	63	80	100
Based on standard	ISO 15552					
Design	Electric cylinder with ball screw or lead screw			Electric cylinder with ball screw		
Piston rod thread						
Male thread	M10x1.25	M12x1.25	M16x1.5	M16x1.5	M20x1.5	M20x1.5
Female thread	M6	M8	M10	M10	M12	M12
Working stroke [mm]	30 ... 800	30 ... 800	30 ... 1000	30 ... 1200	30 ... 1500	30 ... 1500
Protection against torsion/guide	With plain-bearing guide					
Duty cycle [%]	100					
Position sensing	For proximity sensor					
Type of mounting	With female thread/accessories					
Mounting position	Any					

Mechanical data – Ball screw									
Size	32			40			50		
Spindle pitch [mm/rev]	5	10		5	10	16	5	10	20
Spindle diameter [mm]	12			16			20		
Max. force of the cylinder ¹⁾ [kN]	1	1		3	3	2.6	5	5	4.5
Max. driving torque [Nm]	1.1	2		3	5.6	7.7	4.8	9.2	16.3
Max. radial force ²⁾ [N]	115			130			300		
Max. speed [m/s]	0.55	1.1		0.4	0.8	1.2	0.3	0.6	1.2
Max. rotational speed [rpm]	6600	6600		4800	4800	4500	3600	3600	3600
Max. acceleration [m/s ²]	5	15		5	15	25	5	15	25
Max. angle of rotation at the piston rod ³⁾ [°]	±0.25			±0.2			±0.15		
Reversing backlash ³⁾ [mm]	< 0.03	< 0.04		< 0.03	< 0.03	< 0.04	< 0.03	< 0.03	< 0.04
Repetition accuracy [mm]	±0.01								
No-load driving torque ⁴⁾ [Nm]	0.1			0.2			0.3		

Size	63			80			100		
Spindle pitch [mm/rev]	5	10	25	5	15	32	5	20	40
Spindle diameter [mm]	25			32			40		
Max. force of the cylinder ¹⁾ [kN]	7	7	6	12	12	10	17	17	14.5
Max. driving torque [Nm]	7	13.1	26.5	11.9	33.7	56.6	16.9	63.7	102.6
Max. radial force ²⁾ [N]	700			1100			1100		
Max. speed [m/s]	0.27	0.53	1.35	0.21	0.62	1.34	0.16	0.67	1.34
Max. rotational speed [rpm]	3250	3220	3260	2530	2515	2515	2010	2010	2010
Max. acceleration [m/s ²]	5	15	25	5	15	25	5	15	25
Max. angle of rotation at the piston rod ³⁾ [°]	±0.4			±0.5			±0.5		
Reversing backlash ³⁾ [mm]	< 0.03	< 0.03	< 0.04	< 0.03	< 0.03	< 0.04	< 0.03	< 0.03	< 0.04
Repetition accuracy [mm]	±0.015		±0.01						
No-load driving torque ⁴⁾ [Nm]	0.4	0.45	0.5	0.5	0.6	0.65	0.7	0.9	1.0

1) The pressure force is dependent on the stroke and has an effect on the service life → 10

2) On the drive shaft

3) In new condition

4) At a spindle speed of 200 rpm

Electric cylinders ESBF, with spindle drive

Technical data

Mechanical data – Lead screw				
Size		32	40	50
Spindle pitch	[mm/rev]	2.5	3	4
Spindle diameter	[mm]	12	16	20
Max. force of the cylinder ¹⁾	[kN]	0.6	1	1.6
Max. driving torque	[Nm]	1.1	2.4	4.8
Max. radial force ²⁾	[N]	115	130	300
Max. speed	[m/s]	0.05	0.05	0.05
Max. rotational speed	[rpm]	1200	1000	750
Max. acceleration	[m/s ²]	2.5	2.5	2.5
Max. angle of rotation at the piston rod	[°]	±0.25	±0.2	±0.15
Reversing backlash ³⁾	[mm]	< 0.1	< 0.1	< 0.1
Repetition accuracy	[mm]	±0.05		
No-load driving torque ⁴⁾	[Nm]	0.1	0.2	0.3

1) Electric cylinder with lead screw can be operated with maximum force over the entire stroke range.

2) On the drive shaft

3) In new condition

4) At a spindle speed of 200 rpm

Weight [g] – Ball screw						
Size	32	40	50	63	80	100
Basic weight m_0 at 0 mm stroke	781	1237	1982	3165	7393	11123
Additional weight m_{10} per 10 mm stroke	33	47	65	87	155	193
Moving mass m_{b0} at 0 mm stroke	281	467	793	1831	5300	8786
Moving mass m_{b10} per 10 mm stroke	9	26	35	52	103	132

Weight [g] – Lead screw			
Size	32	40	50
Basic weight m_0 at 0 mm stroke	667	1079	1716
Additional weight m_{10} per 10 mm stroke	34	48	67
Moving mass m_{b0} at 0 mm stroke	198	317	532
Moving mass m_{b10} per 10 mm stroke	9	11	13

Total weight $m_{ges.}$:

$$m_{ges.} = m_0 + m_{10} \times \frac{\text{stroke}}{10}$$

Total moving mass $m_{bges.}$:

$$m_{bges.} = m_{b0} + m_{b10} \times \frac{\text{stroke}}{10}$$

 **New**
Sizes: 32, 40, 50

Electric cylinders ESBF, with spindle drive

FESTO

Technical data

Operating and environmental conditions		
Ambient temperature ¹⁾	[°C]	0 ... +60
Storage temperature	[°C]	-20 ... +60
Degree of protection to IEC 60529		
ESBF-...		IP40
ESBF-...-S1		IP65
Relative air humidity	[%]	0 ... 95 (non-condensing)
Duty cycle	[%]	100
Suitable for use in the food industry with ESBF-...-F1 ²⁾		→ extended information on materials
Corrosion resistance class CRC ³⁾		
ESBF-...		2
ESBF-...-R3		3

1) Note operating range of proximity sensors and motors

2) Extended information on materials on request → technical hotline
 Only in combination with ESBF-BS-... (ball screw)

3) Corrosion resistance class CRC 2 to Festo standard FN 940070

Moderate corrosion stress. Indoor applications in which condensation may occur. External visible parts with primarily decorative requirements for the surface and which are in direct contact with the ambient atmosphere typical for industrial applications.

Corrosion resistance class CRC 3 to Festo standard FN 940070

High corrosion stress. Outdoor exposure under moderate corrosive conditions. External visible parts with primarily functional requirements for the surface and which are in direct contact with a normal industrial environment.

Mass moment of inertia – Ball screw										
Size		32			40			50		
Spindle pitch	[mm/rev]	5	10		5	10	16	5	10	20
J_0 at 0 mm stroke	[kg cm ²]	0.023	0.036		0.050	0.078	0.125	0.145	0.187	0.329
j_H per meter stroke	[kg cm ² /m]	0.122	0.139		0.46	0.48	0.523	1.019	1.043	1.139
j_L per kg payload	[kg cm ² /kg]	0.006	0.025		0.006	0.025	0.065	0.006	0.025	0.101

Size		63			80			100		
Spindle pitch	[mm/rev]	5	10	25	5	15	32	5	20	40
J_0 at 0 mm stroke	[kg cm ²]	0.491	0.486	0.65	1.529	1.648	2.119	4.696	5.050	6.71
j_H per meter stroke	[kg cm ² /m]	2.832	2.859	3.053	7.699	7.815	8.277	18.978	19.31	20.372
j_L per kg payload	[kg cm ² /kg]	0.006	0.025	0.158	0.006	0.057	0.259	0.006	0.101	0.405

Mass moment of inertia – Lead screw					
Size		32		40	50
Spindle pitch	[mm/rev]	2.5		3	4
J_0 at 0 mm stroke	[kg cm ²]	0.016		0.045	0.141
j_H per meter stroke	[kg cm ² /m]	0.161		0.508	1.238
j_L per kg payload	[kg cm ² /kg]	0.002		0.002	0.004

The mass moment of inertia J_A of the electric cylinder is calculated as follows:
 $J_A = J_0 + j_H \times \text{working stroke [m]} + j_L \times m_{\text{payload [kg]}}$

Electric cylinders ESBF, with spindle drive

Technical data

Materials

Sectional view

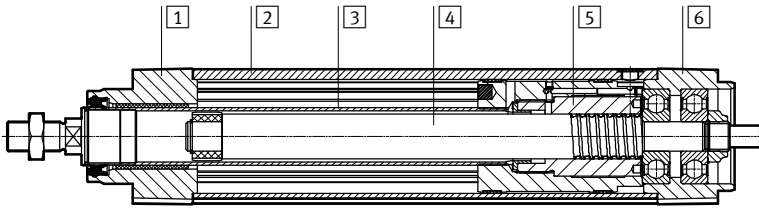

Size	32 ... 50	63 ... 100
1 Bearing cap	Coated wrought aluminium alloy	Coated gravity die-cast aluminium
2 Cylinder barrel	Smooth anodised wrought aluminium alloy	
3 Piston rod	High-alloy stainless steel	
4 Spindle	Rolled steel	
5 Spindle nut	Rolled steel	
6 Drive cover	Coated wrought aluminium alloy	Coated gravity die-cast aluminium
- Note on materials	RoHS compliant Contains paint-wetting impairment substances	

Lateral force F_q as a function of stroke length l

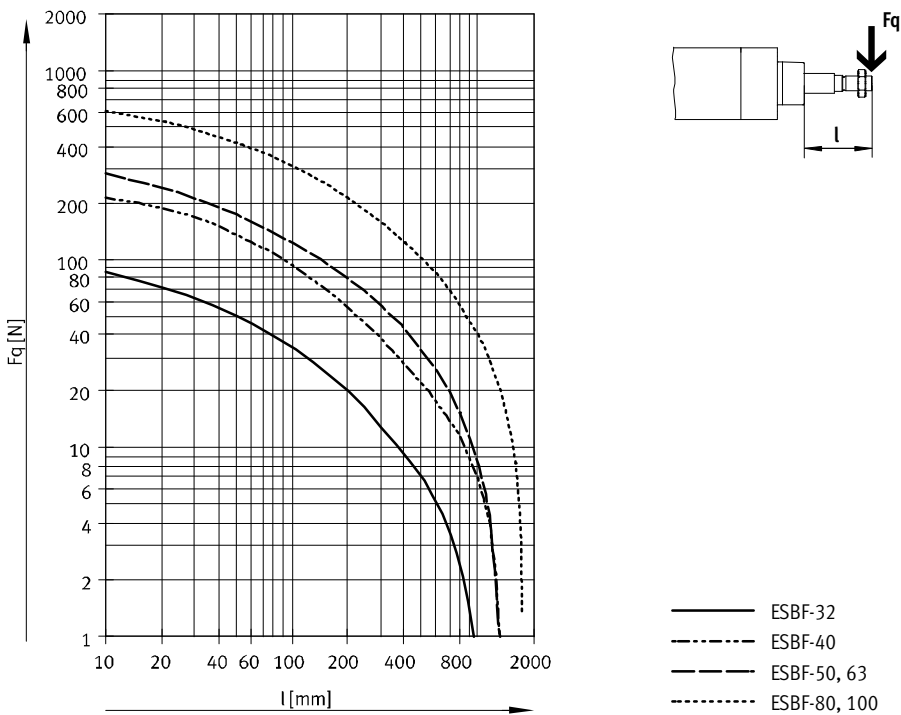

New
Sizes: 32, 40, 50

Electric cylinders ESBF, with spindle drive

Technical data



Max. pressure force F dependent on piston rod length l (l = stroke + optional piston rod extension)

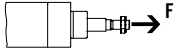

Due to possible buckling, the pressure force must be limited dependent on the stroke.

The tensile force is not affected by this.

For ball screw
 ESBF-BS-32-...

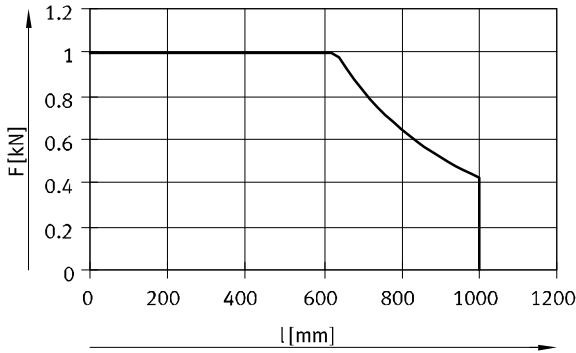

ESBF-BS-32-...-5P/10P

ESBF-BS-40-...

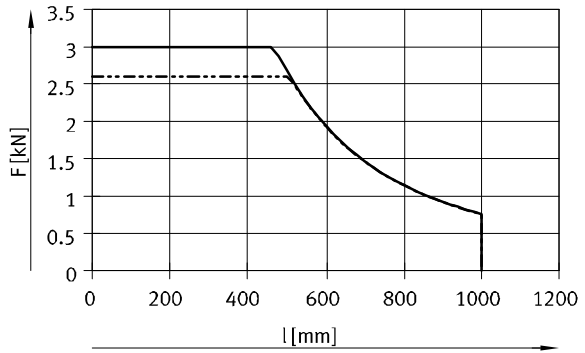

ESBF-BS-40-...-5P/10P
 ESBF-BS-40-...-16P

ESBF-BS-50-...

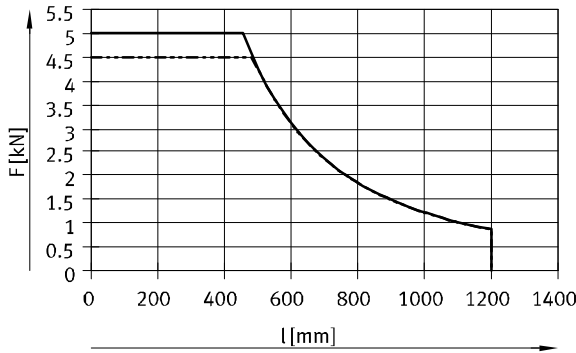

ESBF-BS-50-...-5P/10P
 ESBF-BS-50-...-20P

ESBF-BS-63-...

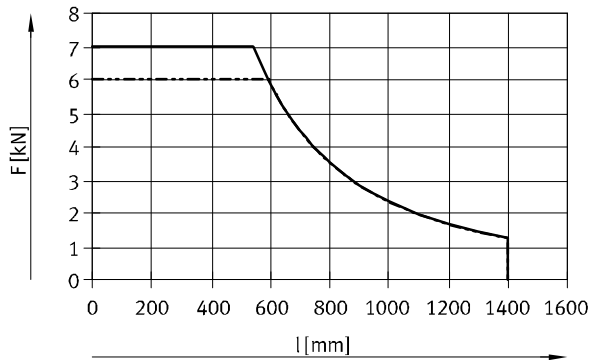

ESBF-BS-63-...-5P/10P
 ESBF-BS-63-...-25P

Electric cylinders ESBF, with spindle drive

Technical data

Max. pressure force F dependent on piston rod length l (l = stroke + optional piston rod extension)

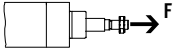

Due to possible buckling, the pressure force must be limited dependent on the stroke.

The tensile force is not affected by this.

For ball screw ESBF-BS-80-...

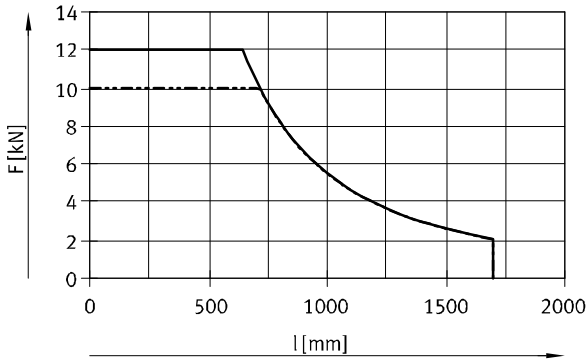

- ESBF-BS-80-...-5P/15P
- - - ESBF-BS-80-...-32P

ESBF-BS-100-...

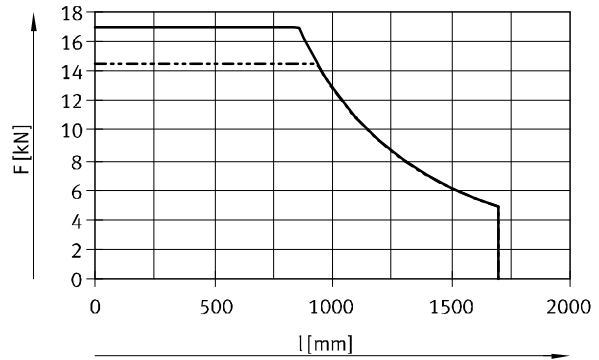

- ESBF-BS-100-...-5P/20P
- - - ESBF-BS-100-...-40P

For lead screw ESBF-LS-...

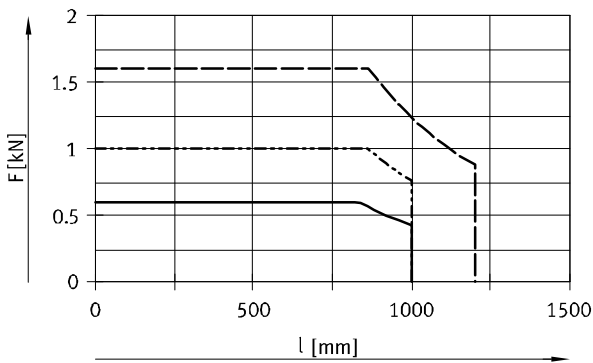

- ESBF-LS-32
- - - ESBF-LS-40
- · - ESBF-LS-50

New
Sizes: 32, 40, 50

Electric cylinders ESBF, with spindle drive

Technical data



Max. feed speed v as a function of stroke length l

For ball screw

ESBF-BS-32-...

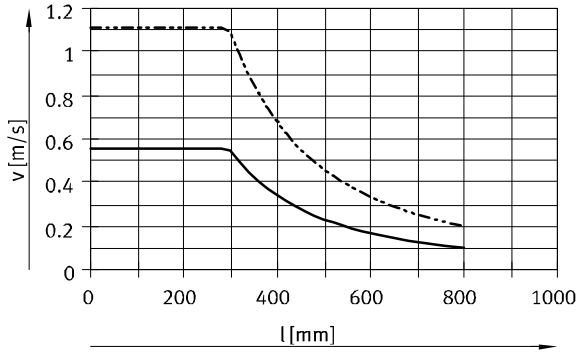

- ESBF-BS-32-...-5P
- - - ESBF-BS-32-...-10P

ESBF-BS-40-...

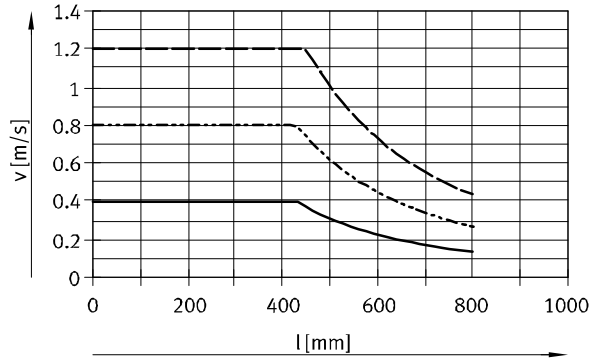

- ESBF-BS-40-...-5P
- - - ESBF-BS-40-...-10P
- · - ESBF-BS-40-...-16P

ESBF-BS-50-...

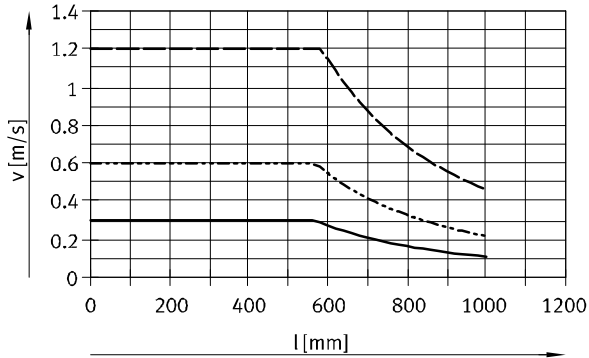

- ESBF-BS-50-...-5P
- - - ESBF-BS-50-...-10P
- · - ESBF-BS-50-...-20P

ESBF-BS-63-...

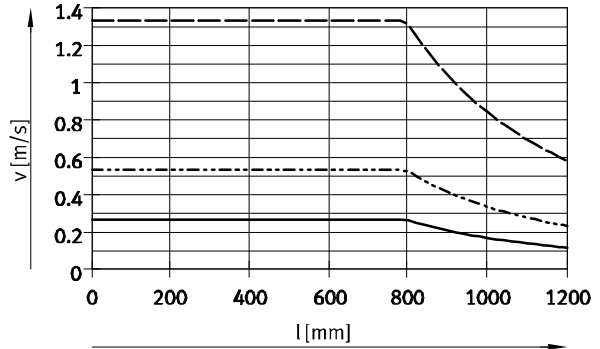

- ESBF-BS-63-...-5P
- - - ESBF-BS-63-...-10P
- · - ESBF-BS-63-...-25P

ESBF-BS-80-...

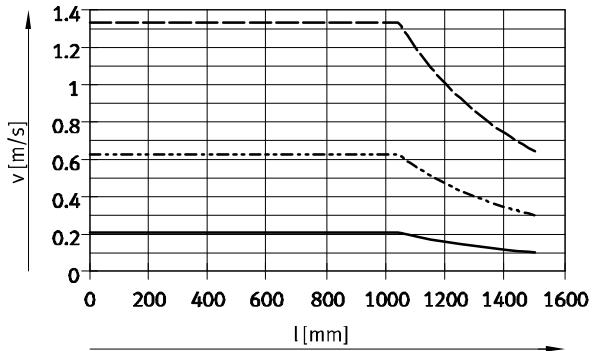

- ESBF-BS-80-...-5P
- - - ESBF-BS-80-...-15P
- · - ESBF-BS-80-...-32P

ESBF-BS-100-...

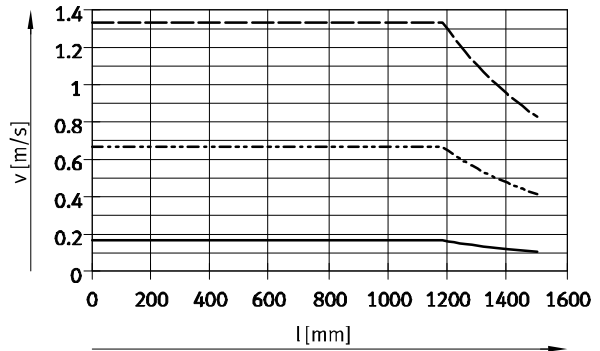

- ESBF-BS-100-...-5P
- - - ESBF-BS-100-...-20P
- · - ESBF-BS-100-...-40P

Electric cylinders ESBF, with spindle drive

Technical data

Maximum feed force F dependent on the feed speed v

For ball screw

ESBF-BS-32-...

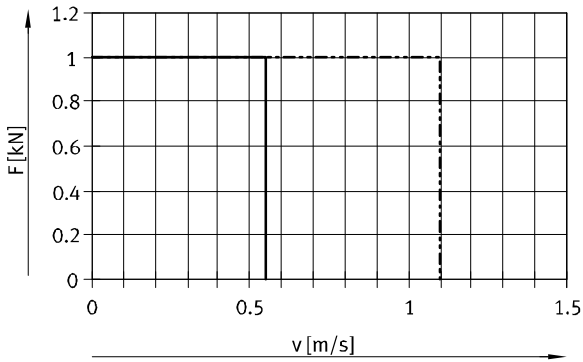

- ESBF-32-...-5P
- - - ESBF-32-...-10P

ESBF-BS-40-...

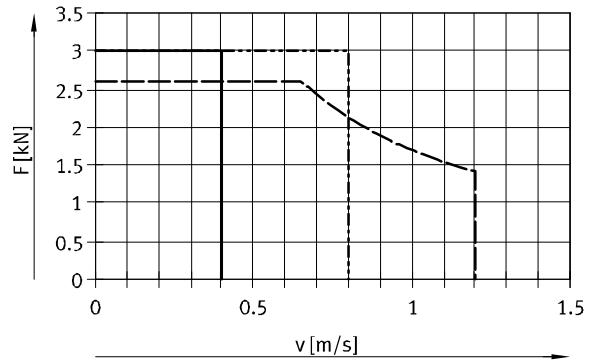

- ESBF-40-...-5P
- - - ESBF-40-...-10P
- · - ESBF-40-...-16P

ESBF-BS-50-...

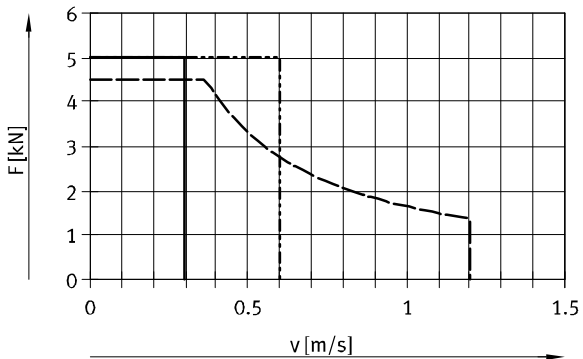

- ESBF-50-...-5P
- - - ESBF-50-...-10P
- · - ESBF-50-...-20P

ESBF-BS-63-...

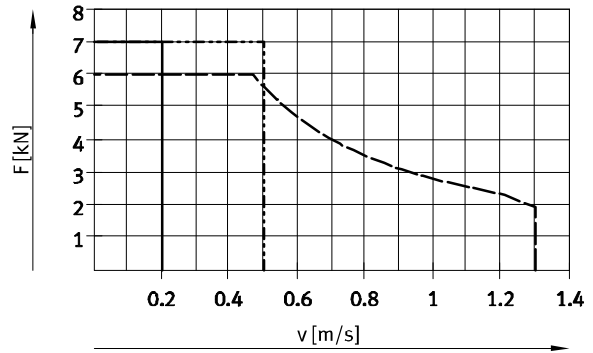

- ESBF-BS-63-...-5P
- - - ESBF-BS-63-...-10P
- · - ESBF-BS-63-...-25P

ESBF-BS-80-...

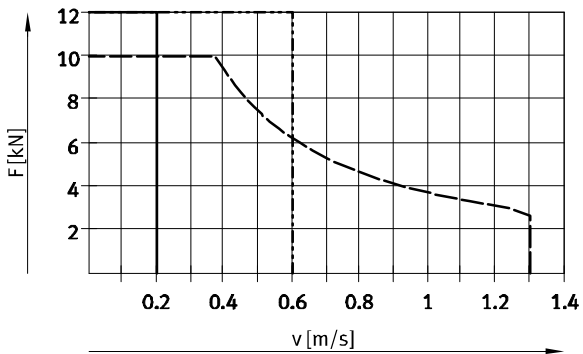

- ESBF-BS-80-...-5P
- - - ESBF-BS-80-...-15P
- · - ESBF-BS-80-...-32P

ESBF-BS-100-...

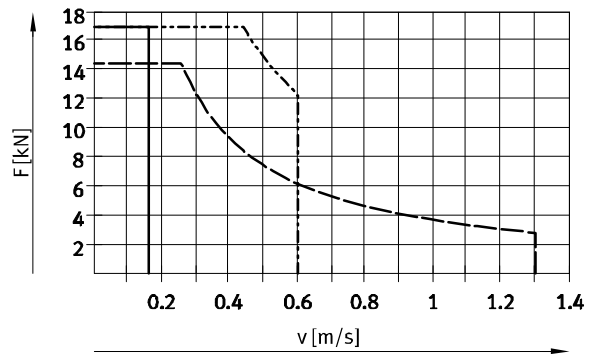

- ESBF-BS-100-...-5P
- - - ESBF-BS-100-...-20P
- · - ESBF-BS-100-...-40P



New

Sizes: 32, 40, 50

Electric cylinders ESBF, with spindle drive

Technical data

FESTO

Maximum feed force F dependent on the feed speed v

For lead screw

ESBF-LS-...

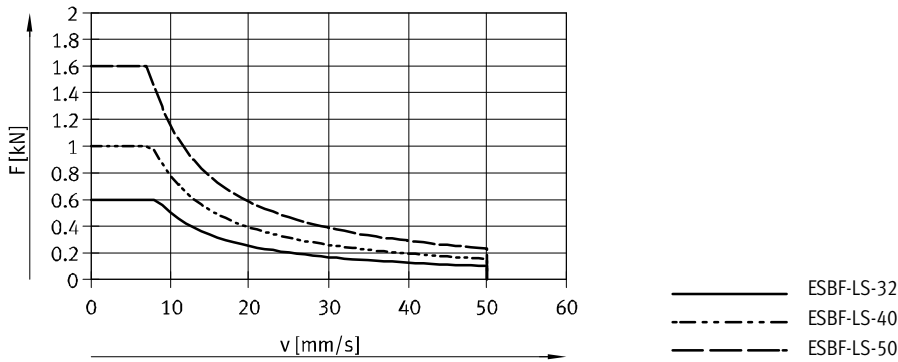

Service life

The service life of the electric cylinder is primarily dependent on the service life of the lead screw. The service life ends once the maximum number of switching cycles (ESBF-BL: 10 million; ESBF-LS: → table on page 15) or the running performance is reached.

The operating coefficient has a significant impact here. The operating coefficient and thus the possible service life can be determined approximately using the table (→ 15).



The specifications for running performance are based on experimentally determined and theoretically calculated data (at room temperature).

The running performance that can be achieved in practice can deviate considerably from the specified curves under different parameters.

Calculation of the mean feed force F_{xm} with ball screw (ESBF-BL)

$$F_{xm} = 3 \sqrt{\frac{F_{x1}^3 \times s_1 + \dots + F_{xn}^3 \times s_n}{s_1 + \dots + s_n}}$$

F_{xm} = Mean feed force

$F_{x1/n}$ = Feed force of section

$s_{1/n}$ = Share of movement cycle that is travel

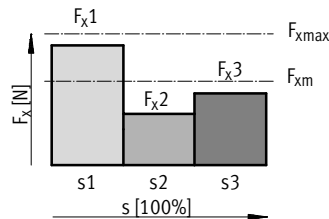

Mean feed force F_{xm} as a function of running performance L, with an operating coefficient f_B of 1.0 at room temperature

For ball screw

ESBF-BL-32-...

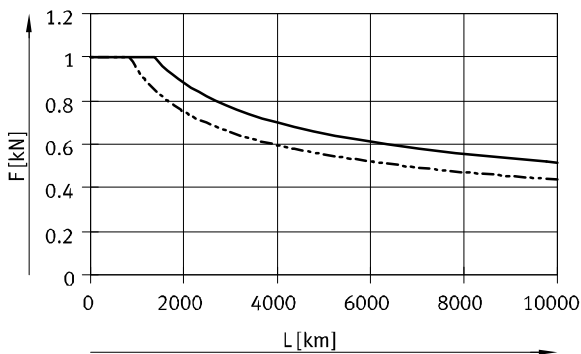

— ESBF-32-...-5P
 - - - ESBF-32-...-10P

ESBF-BL-40-...

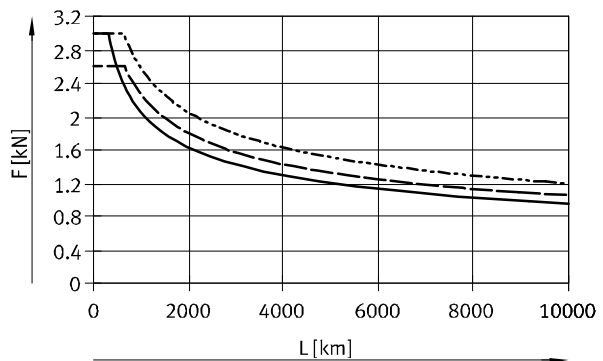

— ESBF-40-...-5P
 - - - ESBF-40-...-10P
 - - - ESBF-40-...-16P

Electric cylinders ESBF, with spindle drive

Technical data

Service life

Mean feed force F_{xm} as a function of running performance L , with an operating coefficient f_B of 1.0 at room temperature

For ball screw

ESBF-BS-50-...

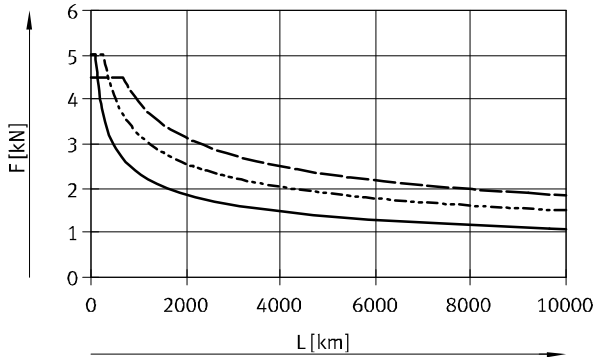

- ESBF-50-...-5P
- - - ESBF-50-...-10P
- · - ESBF-50-...-20P

ESBF-BS-63-...

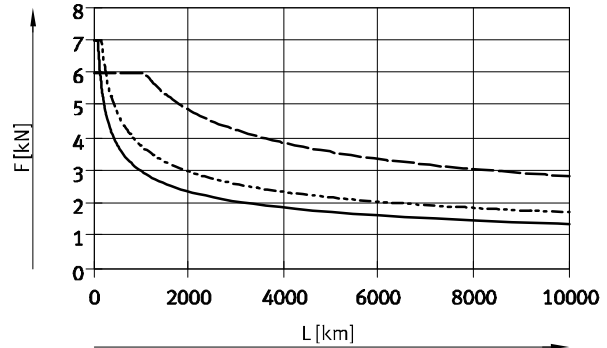

- ESBF-BS-63-...-5P
- - - ESBF-BS-63-...-10P
- · - ESBF-BS-63-...-25P

ESBF-BS-80-...

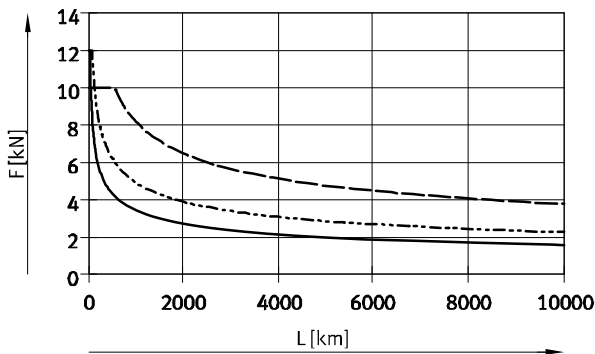

- ESBF-BS-80-...-5P
- - - ESBF-BS-80-...-15P
- · - ESBF-BS-80-...-32P

ESBF-BS-100-...

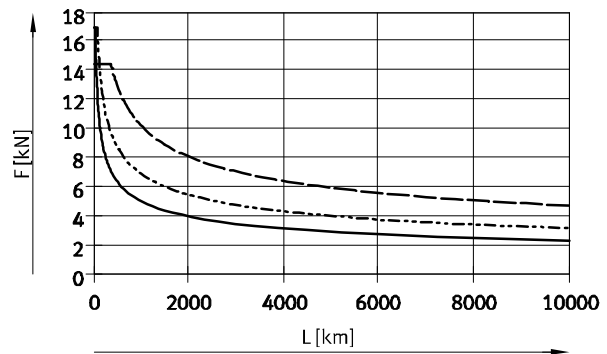

- ESBF-BS-100-...-5P
- - - ESBF-BS-100-...-20P
- · - ESBF-BS-100-...-40P

Life cycle taking into account the operating coefficient

$$L_{ist} = \frac{L}{f_B^3}$$

L_{ist} = Actual service life

L = Target service life

(→ graphs)

f_B = Operating coefficient

Load ¹⁾	Operating coefficient f_B		Sample application
	For ESBF-...	For ESBF-...-F1 (food zone)	
None	1.0 ... 1.2	1.4 ... 1.7	Measuring machine
Lightweight	1.2 ... 1.4	1.7 ... 2.0	Handling, robot technology
Medium	1.4 ... 1.6	2.0 ... 2.3	Press-in operations
High	1.6 ... 2.0	2.3 ... 3.0	Construction, agriculture

1) This refers to loads caused by impacts, temperatures, contamination, shock and vibrations that affect the cylinder or piston rod.

Reference values for lead screw (ESBF-LS)

Size	32	40	50
Running performance L [km]	200	250	300
Stress cycles L^1 [million]	1.0	1.2	1.4
Switching cycles L^2 [million]	0.5	0.6	0.7

1) Movement from position A to B with acceleration and deceleration to stop.

2) Two stress cycles to get back to the starting point.

 **New**
Sizes: 32, 40, 50

Electric cylinders ESBF, with spindle drive



Technical data

Friction losses and driving torque

Friction losses

The friction losses comprise the no-load driving torque and the speed-dependent friction losses.

$$M_{\text{reib}} = M_{\text{leerlauf}} + M_{\text{V}}$$

M_{reib} = Friction torque

M_{leerlauf} = No-load driving torque

M_{V} = Friction torque dependent on the feed speed

Driving torque

The driving torque required for the cylinder comprises the friction torque and the effective torque.

$$M_{\text{antrieb}} = M_{\text{reib}} + M_{\text{nutz}}$$

M_{antrieb} = Required driving torque

M_{reib} = Friction torque

M_{nutz} = Effective torque

No-load driving torque – Ball screw¹⁾

Size	32			40			50		
Spindle pitch [mm/rev]	5	10		5	10	16	5	10	20
No-load driving torque M_{leerlauf} [Nm]	0.1	0.1		0.2	0.2	0.2	0.3	0.3	0.3

Size	63			80			100		
Spindle pitch [mm/rev]	5	10	25	5	15	32	5	20	40
No-load driving torque M_{leerlauf} [Nm]	0.4	0.45	0.5	0.5	0.6	0.65	0.7	0.9	1.0

No-load driving torque – Lead screw¹⁾

Size	32	40	50
Spindle pitch [mm/rev]	2.5	3	4
No-load driving torque M_{leerlauf} [Nm]	0.1	0.2	0.3

1) Corresponds to the required driving torque without load, at a spindle speed of 200 rpm.

Electric cylinders ESBF, with spindle drive

Technical data

Friction torque M_f as a function of feed speed v

For ball screw

ESBF-BS-32-...

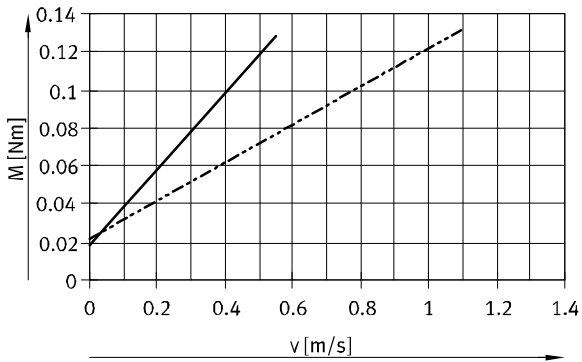

— ESBF-BS-32-...-5P
 - - - ESBF-BS-32-...-10P

ESBF-BS-40-...

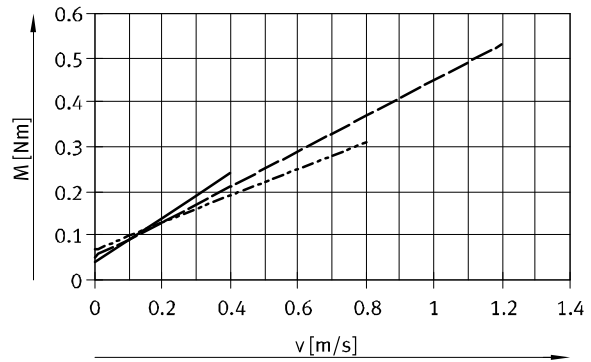

— ESBF-BS-40-...-5P
 - - - ESBF-BS-40-...-10P
 - · - ESBF-BS-40-...-16P

ESBF-BS-50-...

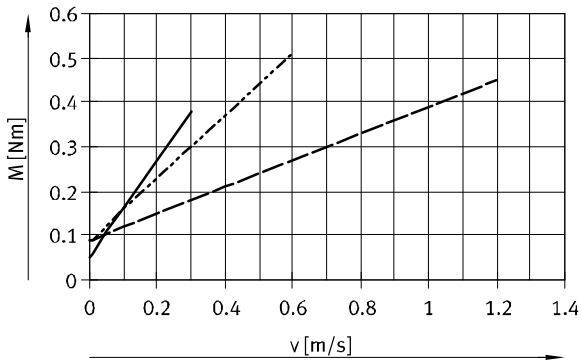

— ESBF-BS-50-...-5P
 - - - ESBF-BS-50-...-10P
 - · - ESBF-BS-50-...-20P

ESBF-BS-63-...

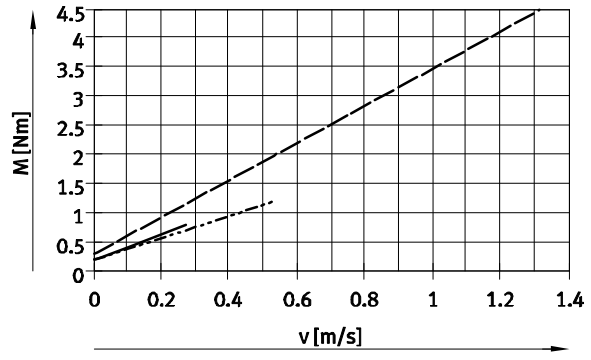

— ESBF-BS-63-...-5P
 - - - ESBF-BS-63-...-10P
 - · - ESBF-BS-63-...-25P

ESBF-BS-80-...

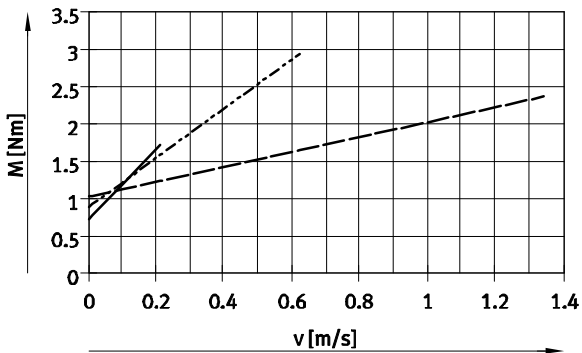

— ESBF-BS-80-...-5P
 - - - ESBF-BS-80-...-15P
 - · - ESBF-BS-80-...-32P

ESBF-BS-100-...

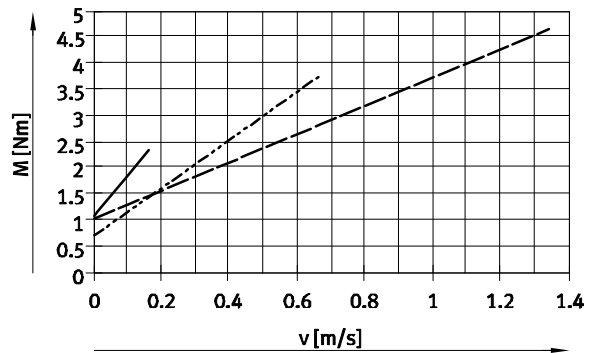

— ESBF-BS-100-...-5P
 - - - ESBF-BS-100-...-20P
 - · - ESBF-BS-100-...-40P



New

Sizes: 32, 40, 50

Electric cylinders ESBF, with spindle drive

Technical data

FESTO

Friction torque M_f as a function of feed speed v

For lead screw

ESBF-LS-...

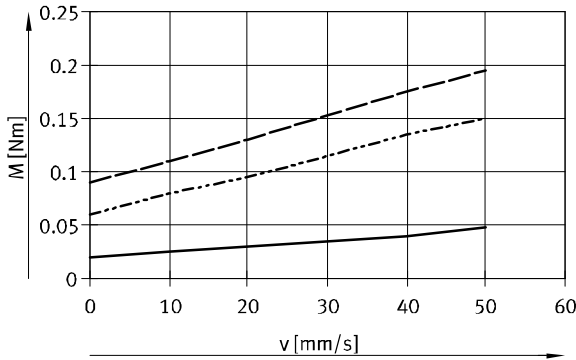

- ESBF-LS-32
- - - ESBF-LS-40
- · - ESBF-LS-50

Effective torque M_{nutz} as a function of feed force F

For ball screw

ESBF-BS-32-...

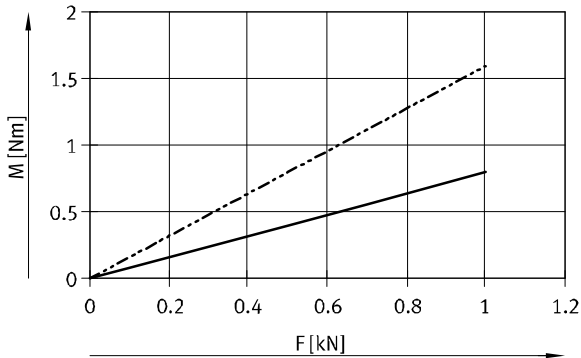

- ESBF-BS-32-...-5P
- - - ESBF-BS-32-...-10P

ESBF-BS-40-...

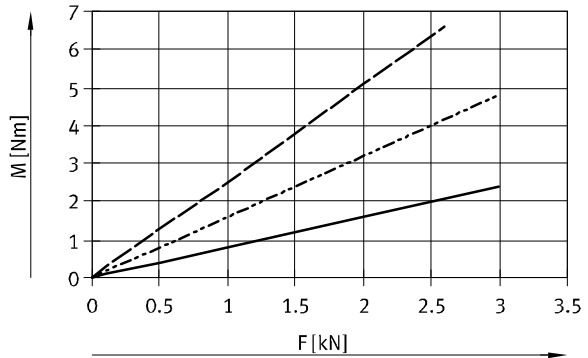

- ESBF-BS-40-...-5P
- - - ESBF-BS-40-...-10P
- · - ESBF-BS-40-...-16P

ESBF-BS-50-...

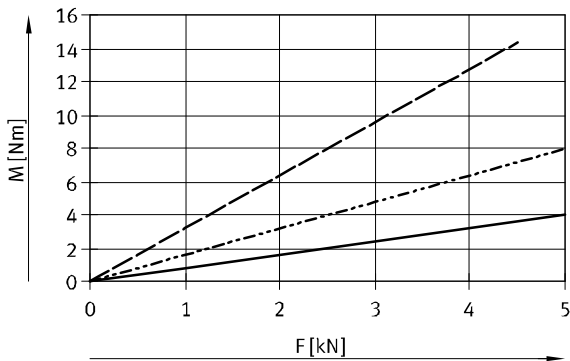

- ESBF-BS-50-...-5P
- - - ESBF-BS-50-...-10P
- · - ESBF-BS-50-...-20P

ESBF-BS-63-...

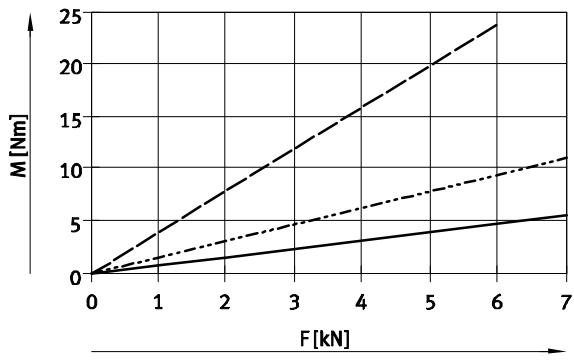

- ESBF-BS-63-...-5P
- - - ESBF-BS-63-...-10P
- · - ESBF-BS-63-...-25P

Electric cylinders ESBF, with spindle drive

Technical data

Effective torque M_{nutz} as a function of feed force F

For ball screw

ESBF-BS-80-...

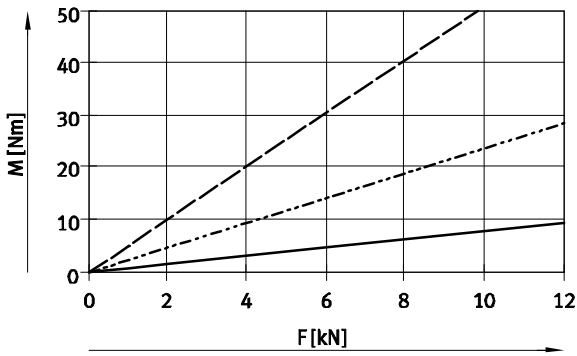

- ESBF-BS-80-...-5P
- - - ESBF-BS-80-...-15P
- · - ESBF-BS-80-...-32P

ESBF-BS-100-...

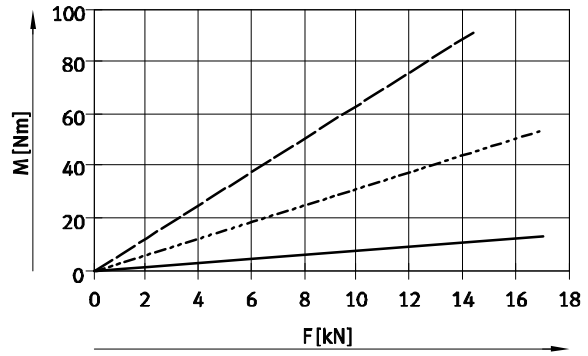

- ESBF-BS-100-...-5P
- - - ESBF-BS-100-...-20P
- · - ESBF-BS-100-...-40P

For lead screw

ESBF-LS-...

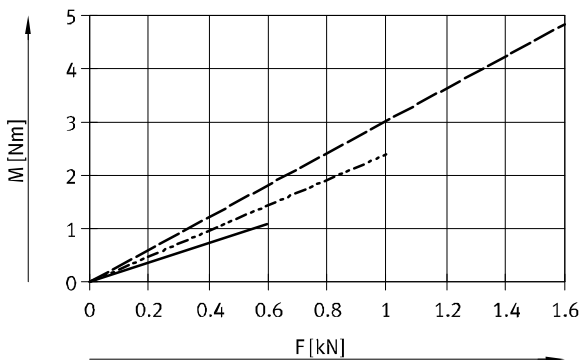

- ESBF-LS-32
- - - ESBF-LS-40
- · - ESBF-LS-50

New
Sizes: 32, 40, 50

Electric cylinders ESBF, with spindle drive

Technical data

FESTO

Dimensions

Download CAD data → www.festo.com

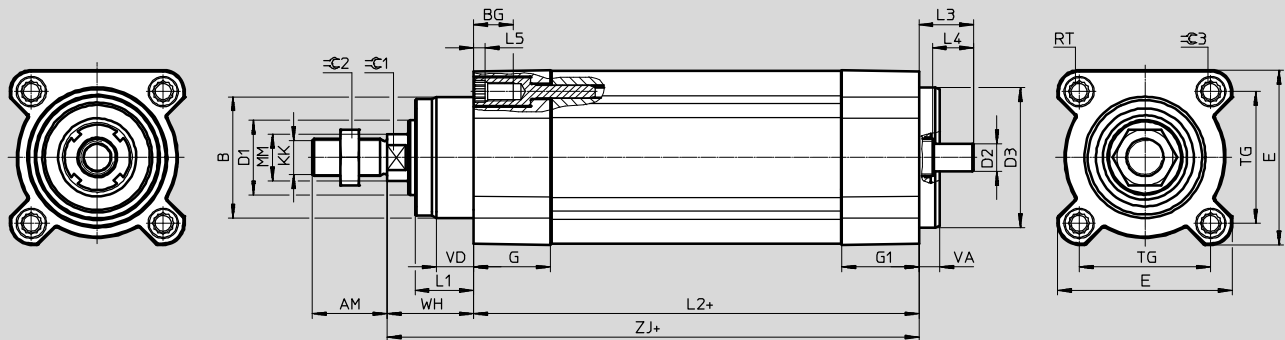

+ = plus stroke length

Size	AM	B	BG	D1	D2	D3	E	G
[mm]	-0.5	\varnothing d11	Min.	\varnothing H9	\varnothing H6	\varnothing f7		
32	22	34	16	20	6	32	$45^{+0,5}$	$25.5_{-0,1}$
40	24	39	16	24	8	40	$54^{+0,5}$	$30_{-0,1}$
50	32	45	17	28	12	50	$64^{+0,5}$	$30_{-0,1}$
63	32	52	17	32	12	60	$75^{+0,5/-0,1}$	$33\pm 0,1$
80	40	60	17	40	19	80	$93^{+0,5/-0,1}$	$39\pm 0,1$
100	40	70	17	50	24	100	$110^{+0,5/-0,1}$	$39\pm 0,1$

Size	G1	L1	L2	L3	L4	L5	KK	MM
[mm]					± 0.2	Min.		\varnothing -0.1
32	$25.5_{-0,1}$	$12^{+0,2}$	$122.5^{+0,2/-1,4}$	$15.9^{+0,8/-0,3}$	8	4	M10x1.25	14
40	$30_{-0,1}$	$14^{+0,2}$	$144^{+0,2/-1,4}$	$18.4^{+0,8/-0,3}$	14	4	M12x1.25	16
50	$34_{-0,1}$	$20^{+0,2}$	$163^{+0,2/-1,4}$	$27^{+0,8/-0,3}$	17	5	M16x1.5	20
63	$33\pm 0,1$	$25_{-0,5}$	$171^{+0,7/-1,2}$	$23.5\pm 0,5$	17	5	M16x1.5	20
80	$39\pm 0,1$	$31_{-0,5}$	$204^{+0,7/-1,2}$	$33.5\pm 0,5$	26	25.9	M20x1.5	25
100	$39\pm 0,1$	$34_{-0,5}$	$224^{+0,7/-1,2}$	$39.5\pm 0,5$	30	25.9	M20x1.5	25

Size	RT	TG	VA	VD	WH	ZJ	\sqrt{Ra}	\sqrt{Rz}	\sqrt{Ra}
[mm]									
32	M6	32.5	$7_{-0,2}$	$8\pm 0,1$	$25.5^{+1,9/-0,8}$	$148^{+2,1/-1,1}$	10	17	6
40	M6	38	$7_{-0,2}$	$9\pm 0,1$	$29.5^{+1,9/-0,8}$	$173.5^{+2,1/-1,1}$	13	19	6
50	M8	46.5	$9_{-0,2}$	$11.5\pm 0,1$	$36.5^{+1,9/-0,8}$	$199.5^{+2,1/-1,1}$	17	24	8
63	M8	$56.5\pm 0,5$	$9\pm 0,2$	$16\pm 0,2$	$37^{+1,8/-1,7}$	208	17	24	8
80	M10	$72\pm 0,5$	$10\pm 0,2$	$18\pm 0,2$	$46^{+1,8/-1,7}$	250	22	30	6
100	M10	$89\pm 0,5$	$12\pm 0,2$	$20\pm 0,2$	$51^{+1,8/-1,7}$	275	22	30	6

Electric cylinders ESBF, with spindle drive

Technical data

Dimensions

Download CAD data → www.festo.com

Variants

...E – Piston rod extension

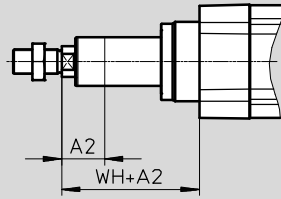

F – Female thread

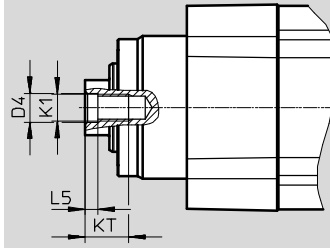

S1 – Protection class IP65/F1 – for the food industry

ESBF-32 ... 50

ESBF-63 ... 100

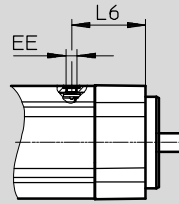
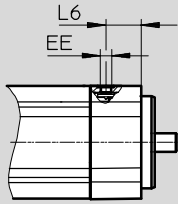

Size	A2	D4	EE	L5	L6	K1	KT	WH
[mm]	Max.	∅		±0.2			Min.	
32	200	6.4 ^{+0,2}	M7	2.6	19.5	M6	12	25.5 ^{+1,9/-0.8}
40	200	8.4 ^{+0,2}	M7	3.3	24	M8	12	29.5 ^{+1,9/-0.8}
50	200	10.5 ^{+0,2}	M7	4.7	28	M10	16	36.5 ^{+1,9/-0.8}
63	200	10.5 ^{+0,1}	G1/8	4.7	48.5	M10	16	37 ^{+1,8/-1.7}
80	200	13 ^{+0,1}	G1/8	6.1	57.5	M12	20	46 ^{+1,8/-1.7}
100	200	13 ^{+0,1}	G1/8	6.1	68.5	M12	20	51 ^{+1,8/-1.7}

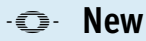

Sizes: 32, 40, 50

Electric cylinders ESBF, with spindle drive

Technical data



Ordering data – Standard design – Ball screw							
Spindle pitch [mm/rev]	Stroke [mm]	Part No.	Type	Spindle pitch [mm/rev]	Stroke [mm]	Part No.	Type
ESBF-32				ESBF-63			
5	100	8022562	ESBF-BS-32-100-5P	5	100	574093	ESBF-BS-63-100-5P
	200	2215384	ESBF-BS-32-200-5P		200	1347390	ESBF-BS-63-200-5P
	300	8022563	ESBF-BS-32-300-5P		300	574094	ESBF-BS-63-300-5P
	400	8022564	ESBF-BS-32-400-5P		400	574095	ESBF-BS-63-400-5P
10	100	8022565	ESBF-BS-32-100-10P	10	100	574096	ESBF-BS-63-100-10P
	200	8022566	ESBF-BS-32-200-10P		200	574097	ESBF-BS-63-200-10P
	300	8022567	ESBF-BS-32-300-10P		300	574098	ESBF-BS-63-300-10P
	400	8022568	ESBF-BS-32-400-10P		400	574099	ESBF-BS-63-400-10P
ESBF-40				ESBF-80			
5	100	8022574	ESBF-BS-40-100-5P	5	100	574104	ESBF-BS-80-100-5P
	200	2215385	ESBF-BS-40-200-5P		200	1347391	ESBF-BS-80-200-5P
	300	8022575	ESBF-BS-40-300-5P		300	574105	ESBF-BS-80-300-5P
	400	8022576	ESBF-BS-40-400-5P		400	574106	ESBF-BS-80-400-5P
10	100	8022577	ESBF-BS-40-100-10P	15	100	574107	ESBF-BS-80-100-15P
	200	8022578	ESBF-BS-40-200-10P		200	574108	ESBF-BS-80-200-15P
	300	8022579	ESBF-BS-40-300-10P		300	574109	ESBF-BS-80-300-15P
	400	8022580	ESBF-BS-40-400-10P		400	574110	ESBF-BS-80-400-15P
16	100	8022581	ESBF-BS-40-100-16P	32	100	574111	ESBF-BS-80-100-32P
	200	8022582	ESBF-BS-40-200-16P		200	574112	ESBF-BS-80-200-32P
	300	8022583	ESBF-BS-40-300-16P		300	574113	ESBF-BS-80-300-32P
	400	8022584	ESBF-BS-40-400-16P		400	574114	ESBF-BS-80-400-32P
ESBF-50				ESBF-100			
5	100	8022590	ESBF-BS-50-100-5P	5	100	574115	ESBF-BS-100-100-5P
	200	2215386	ESBF-BS-50-200-5P		200	1347393	ESBF-BS-100-200-5P
	300	8022591	ESBF-BS-50-300-5P		300	574116	ESBF-BS-100-300-5P
	400	8022592	ESBF-BS-50-400-5P		400	574117	ESBF-BS-100-400-5P
10	100	8022593	ESBF-BS-50-100-10P	20	100	574118	ESBF-BS-100-100-20P
	200	8022594	ESBF-BS-50-200-10P		200	574119	ESBF-BS-100-200-20P
	300	8022595	ESBF-BS-50-300-10P		300	574120	ESBF-BS-100-300-20P
	400	8022596	ESBF-BS-50-400-10P		400	574121	ESBF-BS-100-400-20P
20	100	8022597	ESBF-BS-50-100-20P	40	100	574122	ESBF-BS-100-100-40P
	200	8022598	ESBF-BS-50-200-20P		200	574123	ESBF-BS-100-200-40P
	300	8022599	ESBF-BS-50-300-20P		300	574124	ESBF-BS-100-300-40P
	400	8022600	ESBF-BS-50-400-20P		400	574125	ESBF-BS-100-400-40P



Order variable strokes and variants via the modular product system

→ 24

Electric cylinders ESBF, with spindle drive

Technical data

Ordering data – Standard design – Lead screw			
Spindle pitch [mm/rev]	Stroke [mm]	Part No.	Type
ESBF-32			
2.5	100	8022570	ESBF-LS-32-100-2.5P
	200	2295381	ESBF-LS-32-200-2.5P
	300	8022571	ESBF-LS-32-300-2.5P
	400	8022572	ESBF-LS-32-400-2.5P
ESBF-40			
3	100	8022586	ESBF-LS-40-100-3P
	200	2295382	ESBF-LS-40-200-3P
	300	8022587	ESBF-LS-40-300-3P
	400	8022588	ESBF-LS-40-400-3P
ESBF-50			
4	100	8022602	ESBF-LS-50-100-4P
	200	2295383	ESBF-LS-50-200-4P
	300	8022603	ESBF-LS-50-300-4P
	400	8022604	ESBF-LS-50-400-4P

 - Note

Order variable strokes and variants
 via the modular product system

→ 24

 **New**
Sizes: 32, 40, 50

Electric cylinders ESBF, with spindle drive

FESTO

Ordering data – Modular products

Ordering table										
Size	32	40	50	63	80	100	Conditions	Code	Entry code	
M Module no.	8022569	8022585	8022601	574090	574091	574092				
Function	Electric cylinder								ESBF	ESBF
Drive system	Ball screw						1	-BS		
	Lead screw						2	-LS		
Size	32	40	50	63	80	100		-...		
Stroke [mm]	100								-...	
	200									
	300									
	400									
	30 ... 800	30 ... 800	30 ... 1000	30 ... 1200	30 ... 1500	30 ... 1500				
Spindle pitch [mm]	2.5	-	-	-	-	-		-...P		
	-	3	-	-	-	-				
	-	-	4	-	-	-				
	5	5	5	5	5	5				
	10	10	10	10	-	-				
	-	-	-	-	15	-				
	-	16	-	-	-	-				
	-	-	20	-	-	20				
	-	-	-	25	-	-				
	-	-	-	-	32	-				
O Piston rod thread type	Male thread									
	Female thread							-F		
Degree of protection for electrics	Standard									
	IP65							-S1		
Corrosion protection	Standard									
	High corrosion protection						3	-R3		
Additional features	None									
	Suitable for use in the food industry as per extended information on materials						4	-F1		
Piston rod extension	None									
	1 ... 200							-...E		

- 1 BS** Only with spindle pitch 5P, 10P, 15P, 16P, 20P, 25P, 32P, 40P
- 2 LS** Only with spindle pitch 2.5P, 3P, 4P
- 3 R3** Only with S1
- 4 F1** Only with R3
Not with LS

M Mandatory data
O Options

Transfer order code

ESBF - - - - - - - - - - - -

Electric cylinders ESBF, with spindle drive

Accessories

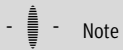

Note

Depending on the combination of motor and drive, it may not be possible to reach the maximum feed force of the drive.

When using parallel kits, the no-load driving torque of the respective kit must be taking into consideration.

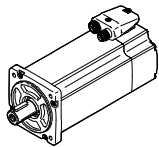
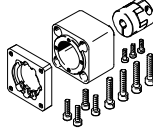
Permissible axis/motor combinations with axial kit		Technical data → Internet: eamm-a
Motor/gear unit ¹⁾	Axial kit	
		
Type	Part No.	Type
ESBF-32		
With servo motor		
EMME-AS-40-...	1976465	EAMM-A-D32-40P
	2207372	EAMM-A-D32-40P-S1 ²⁾
EMMS-AS-40-...	543147	EAMM-A-D32-40A
	1322178	EAMM-A-D32-40A-S1 ²⁾
EMMS-AS-55-...	550979	EAMM-A-D32-55A
	1322180	EAMM-A-D32-55A-S1 ²⁾
EMME-AS-60-...	1956054	EAMM-A-D32-60P
	2234020	EAMM-A-D32-60P-S1 ²⁾
With servo motor and gear unit		
EMME-AS-40-...	1454238	EAMM-A-D32-40G
EMGA-40-P-G...-EAS-40	2256396	EAMM-A-D32-40G-S1 ²⁾
EMMS-AS-40-...	1454238	EAMM-A-D32-40G
EMGA-40-P-G...-SAS-40	2256396	EAMM-A-D32-40G-S1 ²⁾
EMMS-AS-55-...	2946758	EAMM-A-D32-60G
EMGA-60-P-G...-SAS-55	2946759	EAMM-A-D32-60G-S1 ²⁾
EMME-AS-60-...	2946760	EAMM-A-D32-60H
EMGA-60-P-G...-EAS-60	2946761	EAMM-A-D32-60H-S1 ²⁾
EMMS-AS-70-...	2946758	EAMM-A-D32-60G
EMGA-60-P-G...-SAS-70	2946759	EAMM-A-D32-60G-S1 ²⁾
With stepper motor		
EMMS-ST-42-...	543148	EAMM-A-D32-42A
	1322179	EAMM-A-D32-42A-S1 ²⁾
EMMS-ST-57-...	550980	EAMM-A-D32-57A
	1322181	EAMM-A-D32-57A-S1 ²⁾
With stepper motor and gear unit		
EMMS-ST-42-...	1454238	EAMM-A-D32-40G
EMGA-40-P-G...-SST-42	2256396	EAMM-A-D32-40G-S1 ²⁾
EMMS-ST-57-...	2946758	EAMM-A-D32-60G
EMGA-60-P-G...-SST-57	2946759	EAMM-A-D32-60G-S1 ²⁾
With integrated drive		
EMCA-EC-67-...	1454239	EAMM-A-D32-67A
	2256397	EAMM-A-D32-67A-S1 ²⁾
With integrated drive and gear unit		
EMCA-EC-67-...	1454238	EAMM-A-D32-40G
EMGC-40-...	2256396	EAMM-A-D32-40G-S1 ²⁾
EMCA-EC-67-...	2946760	EAMM-A-D32-60H
EMGC-60-...	2946761	EAMM-A-D32-60H-S1 ²⁾

1) The input torque must not exceed the maximum permissible transferable torque of the axial kit.

2) With degree of protection IP65

 **New**
Sizes: 32, 40, 50

Electric cylinders ESBF, with spindle drive

Accessories

FESTO

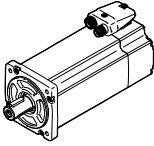
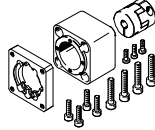
Permissible axis/motor combinations with axial kit		Technical data → Internet: eamm-a	
Motor ¹⁾	Axial kit		
			
Type	Part No.	Type	
ESBF-40			
With servo motor			
EMMS-AS-55-...	543153	EAMM-A-D40-55A	
	1322182	EAMM-A-D40-55A-S1 ²⁾	
EMME-AS-60-...	1977000	EAMM-A-D40-60P	
	2151519	EAMM-A-D40-60P-S1 ²⁾	
EMMS-AS-70-...	550981	EAMM-A-D40-70A	
	1322185	EAMM-A-D40-70A-S1 ²⁾	
With servo motor and gear unit			
EMME-AS-40-...	560282	EAMM-A-D40-40G ³⁾	
EMGA-40-P-G...-EAS-40	2256398	EAMM-A-D40-40G-G2	
	2256399	EAMM-A-D40-40G-S1 ²⁾	
EMMS-AS-40-...	560282	EAMM-A-D40-40G ³⁾	
EMGA-40-P-G...-SAS-40	2256398	EAMM-A-D40-40G-G2	
	2256399	EAMM-A-D40-40G-S1 ²⁾	
EMMS-AS-55-...	2256400	EAMM-A-D40-60G	
EMGA-60-P-G...-SAS-55	2256409	EAMM-A-D40-60G-S1 ²⁾	
EMME-AS-60-...	1454242	EAMM-A-D40-60H	
EMGA-60-P-G...-EAS-60	2256401	EAMM-A-D40-60H-S1 ²⁾	
EMMS-AS-70-...	2256400	EAMM-A-D40-60G	
EMGA-60-P-G...-SAS-70	2256409	EAMM-A-D40-60G-S1 ²⁾	
With stepper motor			
EMMS-ST-57-...	543154	EAMM-A-D40-57A	
	1322183	EAMM-A-D40-57A-S1 ²⁾	
EMMS-ST-87-...	550982	EAMM-A-D40-87A	
	1322186	EAMM-A-D40-87A-S1 ²⁾	
With stepper motor and gear unit			
EMMS-ST-42-...	560282	EAMM-A-D40-40G ³⁾	
EMGA-40-P-G...-SST-42	2256398	EAMM-A-D40-40G-G2	
	2256399	EAMM-A-D40-40G-S1 ²⁾	
EMMS-ST-57-...	2256400	EAMM-A-D40-60G	
EMGA-60-P-G...-SST-57	2256409	EAMM-A-D40-60G-S1 ²⁾	
With integrated drive			
EMCA-EC-67-...	1454243	EAMM-A-D40-67A	
	2256695	EAMM-A-D40-67A-S1 ²⁾	
With integrated drive and gear unit			
EMCA-EC-67-...	560282	EAMM-A-D40-40G ³⁾	
EMGC-40-...	2256398	EAMM-A-D40-40G-G2	
	2256399	EAMM-A-D40-40G-S1 ²⁾	
EMCA-EC-67-...	1454242	EAMM-A-D40-60H	
EMGC-60-...	2256401	EAMM-A-D40-60H-S1 ²⁾	

- 1) The input torque must not exceed the maximum permissible transferable torque of the axial kit.
 2) With degree of protection IP65
 3) Type discontinued

Electric cylinders ESBF, with spindle drive

Accessories

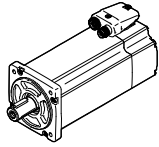
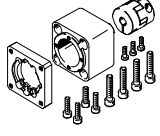
Permissible axis/motor combinations with axial kit		Technical data → Internet: eamm-a
Motor ¹⁾	Axial kit	
		
Type	Part No.	Type
ESBF-50		
With servo motor		
EMMS-AS-70-...	2733783	EAMM-A-D50-70A
	2734287	EAMM-A-D50-70A-S1 ²⁾
EMME-AS-80-...	2733785	EAMM-A-D50-80P
	2734289	EAMM-A-D50-80P-S1 ²⁾
EMME-AS-100-...	2733784	EAMM-A-D50-100A
	2734288	EAMM-A-D50-100A-S1 ²⁾
EMMS-AS-100-...	2733784	EAMM-A-D50-100A
	2734288	EAMM-A-D50-100A-S1 ²⁾
With servo motor and gear unit		
EMMS-AS-55-...	2733786	EAMM-A-D50-60G
EMGA-60-P-G...-SAS-55	2734290	EAMM-A-D50-60G-S1 ²⁾
EMME-AS-60-...	2733796	EAMM-A-D50-60H
EMGA-60-P-G...-EAS-60	2907418	EAMM-A-D50-60H-S1 ²⁾
EMMS-AS-70-...	2733786	EAMM-A-D50-60G
EMGA-60-P-G...-SAS-70	2734290	EAMM-A-D50-60G-S1 ²⁾
EMMS-AS-70-...	2733787	EAMM-A-D50-80G
EMGA-80-P-G...-SAS-70	2734291	EAMM-A-D50-80G-S1 ²⁾
EMME-AS-80-...	2733787	EAMM-A-D50-80G
EMGA-80-P-G...-EAS-80	2734291	EAMM-A-D50-80G-S1 ²⁾
EMMS-AS-100-...	2733787	EAMM-A-D50-80G
EMGA-80-P-G...-SAS-100	2734291	EAMM-A-D50-80G-S1 ²⁾
With stepper motor		
EMMS-ST-87-...	2733781	EAMM-A-D50-87A
	2734286	EAMM-A-D50-87A-S1 ²⁾
With stepper motor and gear unit		
EMMS-ST-57-...	2733786	EAMM-A-D50-60G
EMGA-60-P-G...-SST-57	2734290	EAMM-A-D50-60G-S1 ²⁾
EMMS-ST-87-...	2733787	EAMM-A-D50-80G
EMGA-80-P-G...-SST-87	2734291	EAMM-A-D50-80G-S1 ²⁾
With integrated drive and gear unit		
EMCA-EC-67-...	2733796	EAMM-A-D50-60H
EMGC-60-...	2907418	EAMM-A-D50-60H-S1 ²⁾

1) The input torque must not exceed the maximum permissible transferable torque of the axial kit.

2) With degree of protection IP65

 **Note**

The axial kit (without "S1" in the type code) can be retrofitted with a seal

set EADS-F to change the degree of protection from IP40 to IP65.

Additional information
 → eamm-a

 **New**
Sizes: 32, 40, 50

Electric cylinders ESBF, with spindle drive

Accessories

FESTO

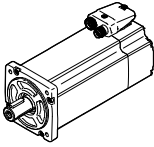
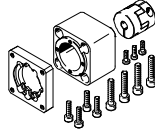
Permissible axis/motor combinations with axial kit		Technical data → Internet: eamm-a	
Motor ¹⁾	Axial kit		
Type	Part No.	Type	
			
ESBF-63			
With servo motor			
EMMS-AS-70-...	543161	EAMM-A-D60-70A	
	2256699	EAMM-A-D60-70A-S1 ²⁾	
EMME-AS-80-...	1977073	EAMM-A-D60-80P	
	2218564	EAMM-A-D60-80P-S1 ²⁾	
EMME-AS-100-...	550983	EAMM-A-D60-100A	
	2256700	EAMM-A-D60-100A-S1 ²⁾	
EMMS-AS-100-...	550983	EAMM-A-D60-100A	
	2256700	EAMM-A-D60-100A-S1 ²⁾	
With servo motor and gear unit			
EMMS-AS-55-...	560283	EAMM-A-D60-60G ³⁾	
EMGA-60-P-G...-SAS-55	2256696	EAMM-A-D60-60G-G2	
	2256698	EAMM-A-D60-60G-S1 ²⁾	
EMME-AS-60-...	1454245	EAMM-A-D60-60H	
EMGA-60-P-G...-EAS-60	2256697	EAMM-A-D60-60H-S1 ²⁾	
EMMS-AS-70-...	560283	EAMM-A-D60-60G ³⁾	
EMGA-60-P-G...-SAS-70	2256696	EAMM-A-D60-60G-G2	
	2256698	EAMM-A-D60-60G-S1 ²⁾	
EMMS-AS-70-...	1499402	EAMM-A-D60-80G	
EMGA-80-P-G...-SAS-70	2946762	EAMM-A-D60-80G-S1 ²⁾	
EMME-AS-80-...	1499402	EAMM-A-D60-80G	
EMGA-80-P-G...-EAS-80	2946762	EAMM-A-D60-80G-S1 ²⁾	
EMMS-AS-100-...	1499402	EAMM-A-D60-80G	
EMGA-80-P-G...-SAS-100	2946762	EAMM-A-D60-80G-S1 ²⁾	
With stepper motor			
EMMS-ST-87-...	543162	EAMM-A-D60-87A	
	1322188	EAMM-A-D60-87A-S1 ²⁾	
With stepper motor and gear unit			
EMMS-ST-57-...	560283	EAMM-A-D60-60G ³⁾	
EMGA-60-P-G...-SST-57	2256696	EAMM-A-D60-60G-G2	
	2256698	EAMM-A-D60-60G-S1 ²⁾	
EMMS-ST-87-...	1499402	EAMM-A-D60-80G	
EMGA-80-P-G...-SST-87	2946762	EAMM-A-D60-80G-S1 ²⁾	
With integrated drive and gear unit			
EMCA-EC-67-...	1454245	EAMM-A-D60-60H	
EMGC-60-...	2256697	EAMM-A-D60-60H-S1 ²⁾	

- 1) The input torque must not exceed the maximum permissible transferable torque of the axial kit.
2) With degree of protection IP65
3) Type discontinued

Electric cylinders ESBF, with spindle drive

Accessories

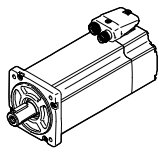
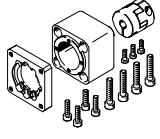
Permissible axis/motor combinations with axial kit		Technical data → Internet: eamm-a
Motor ¹⁾	Axial kit	
		
Type	Part No.	Type
ESBF-80		
With servo motor		
EMME-AS-100	1589665	EAMM-A-D80-100A
	1600673	EAMM-A-D80-100A-S1 ²⁾
EMMS-AS-100-...	1589665	EAMM-A-D80-100A
	1600673	EAMM-A-D80-100A-S1 ²⁾
EMMS-AS-140-...	1588299	EAMM-A-D80-140A
	1600674	EAMM-A-D80-140A-S1 ²⁾
With servo motor and gear unit		
EMMS-AS-70-...	2946763	EAMM-A-D80-80G
EMGA-80-P-G...-SAS-70	2946764	EAMM-A-D80-80G-S1 ²⁾
EMME-AS-80-...	2946763	EAMM-A-D80-80G
EMGA-80-P-G...-EAS-80	2946764	EAMM-A-D80-80G-S1 ²⁾
EMMS-AS-100-...	2946763	EAMM-A-D80-80G
EMGA-80-P-G...-SAS-100	2946764	EAMM-A-D80-80G-S1 ²⁾
With stepper motor and gear unit		
EMMS-ST-87-...	2946763	EAMM-A-D80-80G
EMGA-80-P-G...-SST-87	2946764	EAMM-A-D80-80G-S1 ²⁾
ESBF-100		
With servo motor		
EMME-AS-100	3356796	EAMM-A-D100-100A
	3356931	EAMM-A-D100-100A-S1 ²⁾
EMMS-AS-100-...	3356796	EAMM-A-D100-100A
	3356931	EAMM-A-D100-100A-S1 ²⁾
EMMS-AS-140-...	1588349	EAMM-A-D100-140A
	1600675	EAMM-A-D100-140A-S1 ²⁾
With servo motor and gear unit		
EMMS-AS-100-...	2449341	EAMM-A-D100-120G
EMGA-120-P-G...-SAS-100	2946765	EAMM-A-D100-120G-S1 ²⁾
EMMS-AS-140-...	2449341	EAMM-A-D100-120G
EMGA-120-P-G...-SAS-140	2946765	EAMM-A-D100-120G-S1 ²⁾

1) The input torque must not exceed the maximum permissible transferable torque of the axial kit.

2) With degree of protection IP65

 Note

The axial kit (without "S1" in the type code) can be retrofitted with a seal

set EADS-F to change the degree of protection from IP40 to IP65.



Additional information
 → eamm-a

 **New**
Sizes: 32, 40, 50

Electric cylinders ESBF, with spindle drive

Accessories

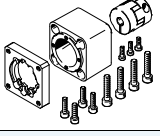
FESTO

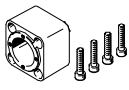
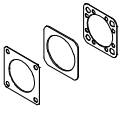

Part components of the axial kit				
Axial kit	Comprises:			
	Motor flange	Coupling	Coupling housing	Seal set
				
Part No. Type	Part No. Type	Part No. Type	Part No. Type	Part No. Type
ESBF-32				
543147 EAMM-A-D32-40A	552163 EAMF-A-28B-40A	543420 EAMC-16-20-6-6	552155 EAMK-A-D32-28B	–
1322178 EAMM-A-D32-40A-S1 ¹⁾				1561526 EADS-F-D32-40A
1454238 EAMM-A-D32-40G	1460095 EAMF-A-44C-40G-S1	562681 EAMC-30-32-6-10	551006 EAMK-A-D32-44A/C	–
2256396 EAMM-A-D32-40G-S1 ¹⁾				2253500 EADS-F-D32-40G
1976465 EAMM-A-D32-40P	1976704 EAMF-A-28B-40P	1232854 EAMC-16-20-6-8	552155 EAMK-A-D32-28B	–
2207372 EAMM-A-D32-40P-S1 ¹⁾				2207219 EADS-F-D32-40P
543148 EAMM-A-D32-42A	552164 EAMF-A-28B-42A	543419 EAMC-16-20-5-6	552155 EAMK-A-D32-28B	–
1322179 EAMM-A-D32-42A-S1 ¹⁾				1561527 EADS-F-D32-42A
550979 EAMM-A-D32-55A	529942 EAMF-A-44A/B-55A	551003 EAMC-30-32-6-9	551006 EAMK-A-D32-44A/C	–
1322180 EAMM-A-D32-55A-S1 ¹⁾				1561528 EADS-F-D32-55A
550980 EAMM-A-D32-57A	530081 EAMF-A-44A/B-57A	551002 EAMC-30-32-6-6.35	551006 EAMK-A-D32-44A/C	–
1322181 EAMM-A-D32-57A-S1 ¹⁾				1561529 EADS-F-D32-57A
2946758 EAMM-A-D32-60G	1460105 EAMF-A-44C-60G/H-S1	3187577 EAMC-30-32-6-11	551006 EAMK-A-D32-44A/C	–
2946759 EAMM-A-D32-60G-S1 ¹⁾				8022150 EADS-F-D32-60G/H
2946760 EAMM-A-D32-60H	1460105 EAMF-A-44C-60G/H-S1	1233256 EAMC-30-32-6-14	551006 EAMK-A-D32-44A/C	–
2946761 EAMM-A-D32-60H-S1 ¹⁾				8022150 EADS-F-D32-60G/H
1956054 EAMM-A-D32-60P	1956846 EAMF-A-44C-60P	1233256 EAMC-30-32-6-14	551006 EAMK-A-D32-44A/C	–
2234020 EAMM-A-D32-60P-S1 ¹⁾				2234012 EADS-F-D32-60P
1454239 EAMM-A-D32-67A	1476305 EAMF-A-44A/B/C-67A-S1	551003 EAMC-30-32-6-9	551006 EAMK-A-D32-44A/C	–
2256397 EAMM-A-D32-67A-S1 ¹⁾				2253501 EADS-F-D32-67A

1) With degree of protection IP65

Electric cylinders ESBF, with spindle drive

Accessories

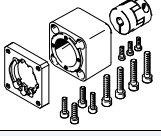
FESTO

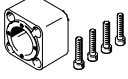
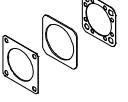
Part components of the axial kit				
Axial kit	Comprises:			
	Motor flange	Coupling	Coupling housing	Seal set
				
Part No. Type	Part No. Type	Part No. Type	Part No. Type	Part No. Type
ESBF-40				
560282 EAMM-A-D40-40G ²⁾	550986 EAMF-A-44A/B-40G	558029 EAMC-30-32-8-10	552157 EAMK-A-D40-44A/C	–
2256398 EAMM-A-D40-40G-G2	1460095 EAMF-A-44C-40G-S1	558029 EAMC-30-32-8-10	552157 EAMK-A-D40-44A/C	–
2256399 EAMM-A-D40-40G-S1 ¹⁾				2253502 EADS-F-D40-40G
543153 EAMM-A-D40-55A	529942 EAMF-A-44A/B-55A	543423 EAMC-30-32-8-9	552157 EAMK-A-D40-44A/C	–
1322182 EAMM-A-D40-55A-S1 ¹⁾				1561530 EADS-F-D40-55A
543154 EAMM-A-D40-57A	530081 EAMF-A-44A/B-57A	543421 EAMC-30-32-6.35-8	552157 EAMK-A-D40-44A/C	–
1322183 EAMM-A-D40-57A-S1 ¹⁾				1561531 EADS-F-D40-57A
2256400 EAMM-A-D40-60G	1460105 EAMF-A-44C-60G/H-S1	551004 EAMC-30-32-8-11	552157 EAMK-A-D40-44A/C	–
2256409 EAMM-A-D40-60G-S1 ¹⁾				2253503 EADS-F-D40-60G/H
1454242 EAMM-A-D40-60H	1460105 EAMF-A-44C-60G/H-S1	562682 EAMC-30-32-8-14	552157 EAMK-A-D40-44A/C	–
2256401 EAMM-A-D40-60H-S1 ¹⁾				2253503 EADS-F-D40-60G/H
1977000 EAMM-A-D40-60P	1956846 EAMF-A-44C-60P	562682 EAMC-30-32-8-14	552157 EAMK-A-D40-44A/C	–
2151519 EAMM-A-D40-60P-S1 ¹⁾				2151545 EADS-F-D40-60P
1454243 EAMM-A-D40-67A	1476305 EAMF-A-44A/B/C-67A-S1	543423 EAMC-30-32-8-9	551006 EAMK-A-D32-44A/C	–
2256695 EAMM-A-D40-67A-S1 ¹⁾				2253501 EADS-F-D32-67A
550981 EAMM-A-D40-70A	529943 EAMF-A-44A/B-70A	551004 EAMC-30-32-8-11	552157 EAMK-A-D40-44A/C	–
1322185 EAMM-A-D40-70A-S1 ¹⁾				1561532 EADS-F-D40-70A
550982 EAMM-A-D40-87A	530082 EAMF-A-44A/B-87A	551004 EAMC-30-32-8-11	552157 EAMK-A-D40-44A/C	–
1322186 EAMM-A-D40-87A-S1 ¹⁾				1561533 EADS-F-D40-87A

1) With degree of protection IP65



2) Type discontinued

 **New**
Sizes: 32, 40, 50

Electric cylinders ESBF, with spindle drive

Accessories

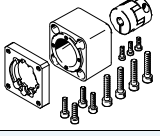
FESTO

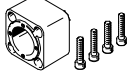
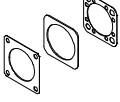

Part components of the axial kit				
Axial kit	Comprises:			
	Motor flange	Coupling	Coupling housing	Seal set
				
Part No. Type	Part No. Type	Part No. Type	Part No. Type	Part No. Type
ESBF-50				
2733786 EAMM-A-D50-60G	2256289 EAMF-A-64B-60G/H-S1	543424 EAMC-42-50-11-12	2733780 EAMK-A-D50-64B	–
2734290 EAMM-A-D50-60G-S1 ¹⁾				2733792 EADS-F-D50-60G/H
2733796 EAMM-A-D50-60H	2256289 EAMF-A-64B-60G/H-S1	1455671 EAMC-42-50-12-14	2733780 EAMK-A-D50-64B	–
2907418 EAMM-A-D50-60H-S1 ¹⁾				2733792 EADS-F-D50-60G/H
2733783 EAMM-A-D50-70A	529945 EAMF-A-64A/B-70A	543424 EAMC-42-50-11-12	2733780 EAMK-A-D50-64B	–
2734287 EAMM-A-D50-70A-S1 ¹⁾				2733789 EADS-F-D50-70A
2733787 EAMM-A-D50-80G	2843290 EAMF-A-64C-80G-S1	2138701 EAMC-42-50-12-20	2836865 EAMK-A-D50-64C	–
2734291 EAMM-A-D50-80G-S1 ¹⁾				2733793 EADS-F-D50-80G
2733785 EAMM-A-D50-80P	1977113 EAMF-A-64A/C-80P	551005 EAMC-42-50-12-19	2836865 EAMK-A-D50-64C	–
2734289 EAMM-A-D50-80P-S1 ¹⁾				2733791 EADS-F-D50-80P
2733781 EAMM-A-D50-87A	533140 EAMF-A-64A/B-87A	543424 EAMC-42-50-11-12	2733780 EAMK-A-D50-64B	–
2734286 EAMM-A-D50-87A-S1 ¹⁾				2733788 EADS-F-D50-87A
2733784 EAMM-A-D50-100A	529947 EAMF-A-64A/C/D-100A	551005 EAMC-42-50-12-19	2836865 EAMK-A-D50-64C	–
2734288 EAMM-A-D50-100A-S1 ¹⁾				2733790 EADS-F-D50-100A
ESBF-63				
560283 EAMM-A-D60-60G ²⁾	550987 EAMF-A-64A/B-60G/H	543424 EAMC-42-50-11-12	552160 EAMK-A-D60-64B	–
2256696 EAMM-A-D60-60G-G2	2256289 EAMF-A-64B-60G/H-S1	543424 EAMC-42-50-11-12	552160 EAMK-A-D60-64B	–
2256698 EAMM-A-D60-60G-S1 ¹⁾				2253505 EADS-F-D60-60G/H
1454245 EAMM-A-D60-60H	2256289 EAMF-A-64B-60G/H-S1	1455671 EAMC-42-50-12-14	552160 EAMK-A-D60-64B	–
2256697 EAMM-A-D60-60H-S1 ¹⁾				2253505 EADS-F-D60-60G/H
543161 EAMM-A-D60-70A	529945 EAMF-A-64A/B-70A	543424 EAMC-42-50-11-12	552160 EAMK-A-D60-64B	–
2256699 EAMM-A-D60-70A-S1 ¹⁾				8022145 EADS-F-D60-70A

1) With degree of protection IP65

2) Type discontinued

Electric cylinders ESBF, with spindle drive

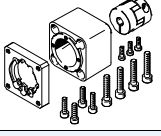
Accessories

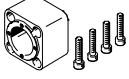
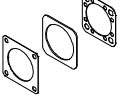
Part components of the axial kit				
Axial kit	Comprises:			
	Motor flange	Coupling	Coupling housing	Seal set
				
Part No. Type	Part No. Type	Part No. Type	Part No. Type	Part No. Type
ESBF-63				
1499402 EAMM-A-D60-80G	2843290 EAMF-A-64C-80G-S1	2138701 EAMC-42-50-12-20	551007 EAMK-A-D60-64C	–
2946762 EAMM-A-D60-80G-S1 ¹⁾				8022146 EADS-F-D60-80G
1977073 EAMM-A-D60-80P	1977113 EAMF-A-64A/C-80P	551005 EAMC-42-50-12-19	551007 EAMK-A-D60-64C	–
2218564 EAMM-A-D60-80P-S1 ¹⁾				2218523 EADS-F-D60-80P
543162 EAMM-A-D60-87A	533140 EAMF-A-64A/B-87A	543424 EAMC-42-50-11-12	552160 EAMK-A-D60-64B	–
1322188 EAMM-A-D60-87A-S1 ¹⁾				1561536 EADS-F-D60-87A
550983 EAMM-A-D60-100A	529947 EAMF-A-64A/C/D-100A	551005 EAMC-42-50-12-19	551007 EAMK-A-D60-64C	–
2256700 EAMM-A-D60-100A-S1 ¹⁾				2253507 EADS-F-D60-100A
ESBF-80				
2946763 EAMM-A-D80-80G	2933286 EAMF-A-77A-80G-S1	3181801 EAMC-56-58-19-20	1593627 EAMK-A-D80-77A	–
2946764 EAMM-A-D80-80G-S1 ¹⁾				8022147 EADS-F-D80-80G
1589665 EAMM-A-D80-100A	1593628 EAMF-A-77A-100A	1485673 EAMC-56-58-19-19	1593627 EAMK-A-D80-77A	–
1600673 EAMM-A-D80-100A-S1 ¹⁾				1593617 EADS-F-D80-100A
1588299 EAMM-A-D80-140A	1593636 EAMF-A-77A-140A	1485674 EAMC-56-58-19-24	1593627 EAMK-A-D80-77A	–
1600674 EAMM-A-D80-140A-S1 ¹⁾				1593671 EADS-F-D80-140A
ESBF-100				
1588349 EAMM-A-D100-140A	1593636 EAMF-A-77A-140A	1451407 EAMC-67-62-24-24	1593914 EAMK-A-D100-77A/B	–
1600675 EAMM-A-D100-140A-S1 ¹⁾				1593991 EADS-F-D100-140A
3356796 EAMM-A-D100-100A	1593628 EAMF-A-77A-100A	1485674 EAMC-56-58-19-24	1593914 EAMK-A-D100-77A/B	–
3356931 EAMM-A-D100-100A-S1 ¹⁾				3356966 EADS-F-D100-100A
2449341 EAMM-A-D100-120G	2449380 EAMF-A-77B-120G-S1	3187895 EAMC-67-62-24-25	1593914 EAMK-A-D100-77A/B	–
2946765 EAMM-A-D100-120G-S1 ¹⁾				8022148 EADS-F-D100-120G

1) With degree of protection IP65

2) Type discontinued

 **New**
Sizes: 32, 40, 50

Electric cylinders ESBF, with spindle drive

FESTO

Accessories

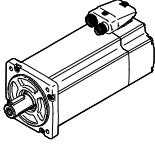
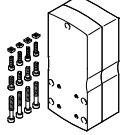
Permissible axis/motor combinations with parallel kit		Technical data → Internet: eamm-u
Motor/gear unit ¹⁾	Parallel kit	
		<ul style="list-style-type: none"> • Increased housing rigidity • More flexible motor mounting possible • Larger toothed belt bending radii for improved service life • Components can be mounted to the kit facing any direction • Use in combination with third-party motors on request
Type	Part No.	Type
ESBF-32		
With servo motor		
EMME-AS-40-...	2153283	EAMM-U-50-D32-40P-78
	2154009	EAMM-U-50-D32-40P-78-S1 ²⁾
EMMS-AS-40-...	1201591	EAMM-U-50-D32-40A-78
	1202302	EAMM-U-50-D32-40A-78-S1 ²⁾
EMMS-AS-55-...	1210126	EAMM-U-60-D32-55A-91
	1210450	EAMM-U-60-D32-55A-91-S1 ²⁾
EMME-AS-60-...	2619586	EAMM-U-70-D32-60P-96
	2619688	EAMM-U-70-D32-60P-96-S1 ²⁾
EMMS-AS-70-...	2755565	EAMM-U-70-D32-70A-96
	2781711	EAMM-U-70-D32-70A-96-S1 ²⁾
With stepper motor		
EMMS-ST-42-...	1201607	EAMM-U-50-D32-42A-78
	1202312	EAMM-U-50-D32-42A-78-S1 ²⁾
EMMS-ST-57-...	1210419	EAMM-U-60-D32-57A-91
	1210453	EAMM-U-60-D32-57A-91-S1 ²⁾
With gear unit		
EMGA-40-P-..., EMGC-40-P-...	1577358	EAMM-U-60-D32-40G-91
	1577346	EAMM-U-60-D32-40G-91-S1 ²⁾
EMGA-60-P-...-SAS/SST ³⁾	2748181	EAMM-U-70-D32-60G-96
	2778302	EAMM-U-70-D32-60G-96-S1 ²⁾
EMGA-60-P-...-EAS, EMGC-60-P-... ³⁾	2778393	EAMM-U-70-D32-60H-96
	2781450	EAMM-U-70-D32-60H-96-S1 ²⁾
With motor unit ⁴⁾		
MTR-DCI-32S-...	1570862	EAMM-U-50-D32-32B-78
MTR-DCI-42S-...	1577393	EAMM-U-60-D32-42B/C-91
MTR-DCI-52S-...	2755890	EAMM-U-70-D32-52B/C-96
ESBF-40		
With servo motor		
EMMS-AS-55-...	1210438	EAMM-U-60-D40-55A-91
	1210458	EAMM-U-60-D40-55A-91-S1 ²⁾
EMME-AS-60-...	2617488	EAMM-U-70-D40-60P-96
	2546123	EAMM-U-70-D40-60P-96-S1 ²⁾
EMMS-AS-70-...	2786204	EAMM-U-70-D40-70A-96
	2786316	EAMM-U-70-D40-70A-96-S1 ²⁾
EMMS-AS-70-...	1212826	EAMM-U-86-D40-70A-102
	1212854	EAMM-U-86-D40-70A-102-S1 ²⁾
EMME-AS-80-...	2802441	EAMM-U-86-D40-80P-102
	2802656	EAMM-U-86-D40-80P-102-S1 ²⁾

1) The input torque must not exceed the maximum permissible transferable torque of the parallel kit.

2) With degree of protection IP65

3) Gear unit drive shaft diameter: EMGA-60-P-...-SAS/-SST11 mm; EMGA-60-P-...-EAS, EMGC-60-P14 mm

4) Only in combination with ESBF-LS-...

Electric cylinders ESBF, with spindle drive

Accessories

FESTO

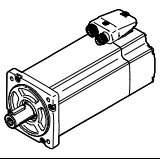
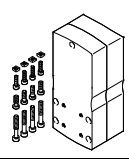
Permissible axis/motor combinations with parallel kit		Technical data → Internet: eamm-u
Motor/gear unit ¹⁾	Parallel kit	
		<ul style="list-style-type: none"> • Increased housing rigidity • More flexible motor mounting possible • Larger toothed belt bending radii for improved service life • Use in combination with third-party motors on request
Type	Part No.	Type
ESBF-40		
With stepper motor		
EMMS-ST-57-...	1210442	EAMM-U-60-D40-57A-91
	1210462	EAMM-U-60-D40-57A-91-S1²⁾
EMMS-ST-87-...	1215802	EAMM-U-86-D40-87A-102
	1215814	EAMM-U-86-D40-87A-102-S1²⁾
With gear unit		
EMGA-40-P-..., EMGC-40-P-...	1577165	EAMM-U-60-D40-40G-91
	1435968	EAMM-U-60-D40-40G-91-S1²⁾
EMGA-60-P-...-SAS/SST³⁾	2785471	EAMM-U-70-D40-60G-96
	2785542	EAMM-U-70-D40-60G-96-S1²⁾
EMGA-60-P-...-EAS, EMGC-60-P-...³⁾	2786101	EAMM-U-70-D40-60H-96
	2786137	EAMM-U-70-D40-60H-96-S1²⁾
EMGA-60-P-...-SAS/SST³⁾	1586445	EAMM-U-86-D40-60G-102
	1586429	EAMM-U-86-D40-60G-102-S1²⁾
EMGA-60-P-...-EAS, EMGC-60-P-...³⁾	1586496	EAMM-U-86-D40-60H-102
	1586372	EAMM-U-86-D40-60H-102-S1²⁾
With motor unit ⁴⁾		
MTR-DCI-42S-...	1570950	EAMM-U-60-D40-42B/C-91
MTR-DCI-52S-...	2786802	EAMM-U-70-D40-52B/C-96
MTR-DCI-52S-...	1537046	EAMM-U-86-D40-52B/C-102
ESBF-50		
With servo motor		
EMMS-AS-70-...	2786899	EAMM-U-70-D50-70A-96
	2756078	EAMM-U-70-D50-70A-96-S1²⁾
EMME-AS-80-...	2803053	EAMM-U-86-D50-80P-102
	2803073	EAMM-U-86-D50-80P-102-S1²⁾
EMME-AS-100-...	2799424	EAMM-U-110-D50-100A-120
	2799488	EAMM-U-110-D50-100A-120-S1²⁾
EMMS-AS-100-...	2799424	EAMM-U-110-D50-100A-120
	2799488	EAMM-U-110-D50-100A-120-S1²⁾
With stepper motor		
EMMS-ST-87-...	2802708	EAMM-U-86-D50-87A-102
	2802742	EAMM-U-86-D50-87A-102-S1²⁾

1) The input torque must not exceed the maximum permissible transferable torque of the parallel kit.

2) With degree of protection IP65

3) Gear unit drive shaft diameter: EMGA-60-P-...-SAS/-SST11 mm; EMGA-60-P-...-EAS, EMGC-60-P14 mm

4) Only in combination with ESBF-LS-...

 **Note**

The clamping component EADT is required to adjust the toothed belt pretension with EAMM-U-110.

The motor and/or axis shaft can optionally be supported with a counter bearing EAMG.

Additional information
 → eamm-u

 **New**
Sizes: 32, 40, 50

Electric cylinders ESBF, with spindle drive

FESTO

Accessories

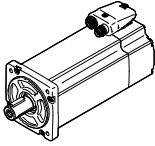
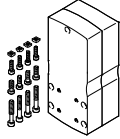
Permissible axis/motor combinations with parallel kit		Technical data → Internet: eamm-u
Motor/gear unit ¹⁾	Parallel kit	
		<ul style="list-style-type: none"> • Increased housing rigidity • More flexible motor mounting possible • Larger toothed belt bending radii for improved service life • Components can be mounted to the kit facing any direction • Use in combination with third-party motors on request
Type	Part No.	Type
ESBF-50		
With gear unit		
EMGA-60-P-...-SAS/SST ³⁾	2803125	EAMM-U-86-D50-60G-102
	2803197	EAMM-U-86-D50-60G-102-S1 ²⁾
EMGA-60-P-...-EAS, EMGC-60-P-... ³⁾	2803326	EAMM-U-86-D50-60H-102
	2803325	EAMM-U-86-D50-60H-102-S1 ²⁾
EMGA-60-P-...-SAS/SST ³⁾	2797368	EAMM-U-110-D50-60G-120
	2798665	EAMM-U-110-D50-60G-120-S1 ²⁾
EMGA-60-P-...-EAS, EMGC-60-P-... ³⁾	2798760	EAMM-U-110-D50-60H-120
	2799150	EAMM-U-110-D50-60H-120-S1 ²⁾
EMGA-80-P-...	2799196	EAMM-U-110-D50-80G-120
	2799281	EAMM-U-110-D50-80G-120-S1 ²⁾
ESBF-63		
With servo motor		
EMMS-AS-70-...	1212477	EAMM-U-86-D60-70A-102
	1212835	EAMM-U-86-D60-70A-102-S1 ²⁾
EMME-AS-80-...	2155875	EAMM-U-86-D60-80P-102
	2156527	EAMM-U-86-D60-80P-102-S1 ²⁾
EMME-AS-100-...	1202436	EAMM-U-110-D60-100A-120
	1203112	EAMM-U-110-D60-100A-120-S1 ²⁾
EMMS-AS-100-...	1202436	EAMM-U-110-D60-100A-120
	1203112	EAMM-U-110-D60-100A-120-S1 ²⁾
With stepper motor		
EMMS-ST-87-...	1215784	EAMM-U-86-D60-87A-102
	1215810	EAMM-U-86-D60-87A-102-S1 ²⁾
With gear unit		
EMGA-60-P-...-SAS/SST ³⁾	1586347	EAMM-U-86-D60-60G-102
	1437163	EAMM-U-86-D60-60G-102-S1 ²⁾
EMGA-60-P-...-EAS, EMGC-60-P-... ³⁾	1586276	EAMM-U-86-D60-60H-102
	1530837	EAMM-U-86-D60-60H-102-S1 ²⁾
EMGA-60-P-...-SAS/SST ³⁾	1543240	EAMM-U-110-D60-60G-120
	1436183	EAMM-U-110-D60-60G-120-S1 ²⁾
EMGA-60-P-...-EAS, EMGC-60-P-... ³⁾	1542264	EAMM-U-110-D60-60H-120
	1530621	EAMM-U-110-D60-60H-120-S1 ²⁾
EMGA-80-P-...	1532949	EAMM-U-110-D60-80G-120
	1530875	EAMM-U-110-D60-80G-120-S1 ²⁾

1) The input torque must not exceed the maximum permissible transferable torque of the parallel kit.

2) With degree of protection IP65

3) Gear unit drive shaft diameter: EMGA-60-P-...-SAS/-SST11 mm; EMGA-60-P-...-EAS, EMGC-60-P14 mm

Note

The clamping component EADT is required to adjust the toothed belt pretension with EAMM-U-110.

The motor and/or axis shaft can optionally be supported with a counter bearing EAMG.

Additional information
 → eamm-u

Electric cylinders ESBF, with spindle drive

Accessories

FESTO

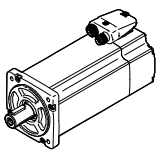
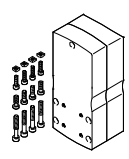
Permissible axis/motor combinations with parallel kit		Technical data → Internet: eamm-u
Motor/gear unit ¹⁾	Parallel kit	
		<ul style="list-style-type: none"> • Increased housing rigidity • More flexible motor mounting possible • Larger toothed belt bending radii for improved service life • Components can be mounted to the kit facing any direction • Use in combination with third-party motors on request
Type	Part No.	Type
ESBF-80		
With servo motor		
EMME-AS-100-...	1465438	EAMM-U-110-D80-100A-120
	1433650	EAMM-U-110-D80-100A-120-S1²⁾
EMMS-AS-100-...	1465438	EAMM-U-110-D80-100A-120
	1433650	EAMM-U-110-D80-100A-120-S1²⁾
EMMS-AS-140-...	1465530	EAMM-U-145-D80-140A-188
	1433709	EAMM-U-145-D80-140A-188-S1²⁾
With gear unit		
EMGA-80-P-...	1589614	EAMM-U-110-D80-80G-120
	1589706	EAMM-U-110-D80-80G-120-S1²⁾
ESBF-100		
With servo motor		
EMMS-AS-140-...	1465541	EAMM-U-145-D100-140A-188
	1433852	EAMM-U-145-D100-140A-188-S1²⁾
With gear unit		
EMGA-120-P-...	2803620	EAMM-U-145-D100-120G-188
	2803622	EAMM-U-145-D100-120G-188-S1²⁾

1) The input torque must not exceed the maximum permissible transferable torque of the parallel kit.

2) With degree of protection IP65

Note

The clamping component EADT is required to adjust the toothed belt pretension with EAMM-U-110.

The motor and/or axis shaft can optionally be supported with a counter bearing EAMG.

Additional information
 → eamm-u

New
Sizes: 32, 40, 50

Electric cylinders ESBF, with spindle drive

Accessories

FESTO

Protective bellows kit EADB



General technical data						
Type EADB-V2-		32	40	50	63	80
Max. stroke range of cylinder ¹⁾	[mm]	30 ... 500	30 ... 500	30 ... 500	30 ... 500	30 ... 500
Type of mounting		Push-on				
		Via threaded pin				
Mounting position		Any				
Resistance to media		Dust, chippings, oil, grease, petrol (→ Internet: Resistance to media)				
Ambient temperature ²⁾	[°C]	-10 ... +80				
Degree of protection to IEC 60529		IP65				
Corrosion resistance class CRC ³⁾		3				

1) In combination with the protective bellows kit EADB

2) Note operating range of proximity sensors and cylinder

3) Corrosion resistance class CRC 3 to Festo standard FN 940070

High corrosion stress. Outdoor exposure under moderate corrosive conditions. External visible parts with primarily functional requirements for the surface and which are in direct contact with a normal industrial environment.

Materials

Sectional view

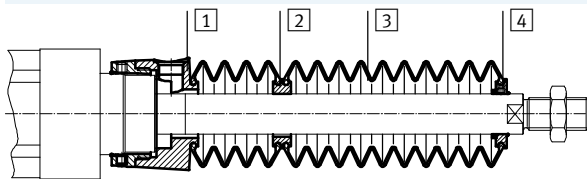

Bellows		
1	Connection	Anodised wrought aluminium alloy
2	Adapter	Polyamide
3	Bellows	NBR
4	End piece	Anodised wrought aluminium alloy
-	O-ring	NBR
Note on materials		Free of copper and PTFE RoHS compliant

Weight [g]						
Type EADB-V2- Stroke [mm]		32	40	50	63	80
Product weight						
10 ... 100		116	109	190	203	269
101 ... 200		155	146	261	265	327
201 ... 300		173	164	306	307	365
301 ... 400		212	201	377	370	423
401 ... 500		233	222	402	391	444
Moving mass						
10 ... 100		46	44	93	79	72
101 ... 200		85	82	164	142	130
201 ... 300		104	99	209	183	168
301 ... 400		143	137	280	246	226
401 ... 500		163	157	305	267	247

Electric cylinders ESBF, with spindle drive

Accessories

Travel speed v as a function of tubing length l



The protective bellows kit is a leak-free system. To prevent unwanted media from being drawn in, the supply and exhaust air for the kit must be ducted

via a pressure compensation hole in the connection part [1]. The pressure generated in the protective bellows kit by the positioning motion is primarily defined by the travel

speed and tubing length. The recommended tubing length based on the travel speed of the drive can be read from the graph.

For size 32

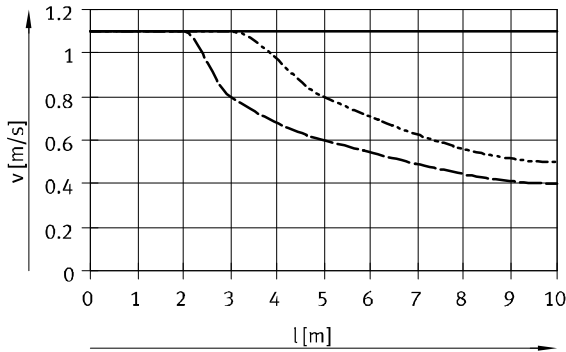

- with QS-G1/4-12, QSH-16-12, PUN-16x2,5
- - - with QS-G1/4-12, PUN-12x2
- · - with QS-G1/4-10, PUN-10x1,5

For size 40

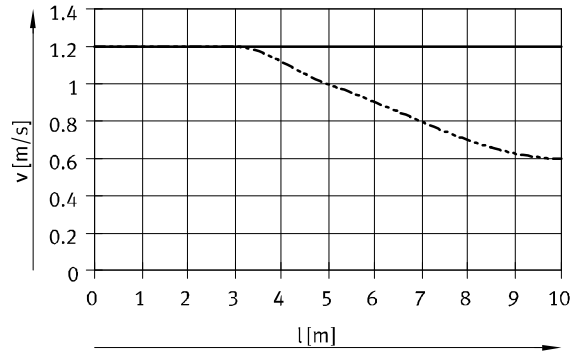

- with QS-G1/4-12, QSH-16-12, PUN-16x2,5
- - - with QS-G1/4-10, PUN-10x1,5

For size 50

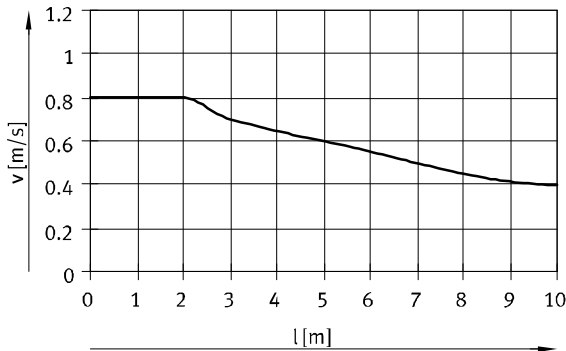

- with QS-G1/4-12, QSH-16-12, PUN-16x2,5

For size 63

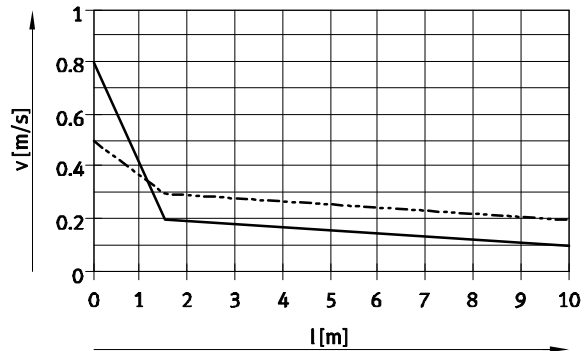

- with QS-G1/4-12, PUN-12x2
- - - with QS-G1/4-12, QSH-16-12, PUN-16x2,5

For size 80

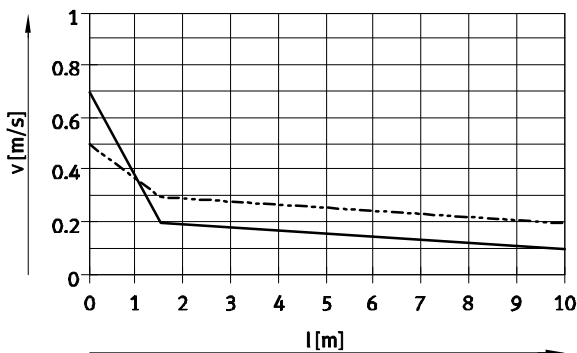

- with QS-G1/4-12, PUN-12x2
- - - with QS-G1/4-12, QSH-16-12, PUN-16x2,5

New
Sizes: 32, 40, 50

Electric cylinders ESBF, with spindle drive

Accessories

FESTO

Tube size and push-in fitting for pressure compensation hole

The push-in fittings in the following table must be used for the pressure compensation hole.

Silencers can be used as an alternative. This reduces the travel speed slightly.

Ø [mm]	Tubing O.D. [mm]	Push-in fitting		Push-in sleeve		Plastic tubing Type
		Part No.	Type	Part No.	Type	
32, 40, 50, 63, 80	16	186350	QS-G $\frac{1}{4}$ -12	153261	QSH-16-12	PUN-16x2,5
32, 63, 80	12	186350	QS-G $\frac{1}{4}$ -12	-	-	PUN-12x2
32, 40	10	186101	QS-G $\frac{1}{4}$ -10	-	-	PUN-10x1,5

Dimensions

Download CAD data → www.festo.com

For size 32 ... 50

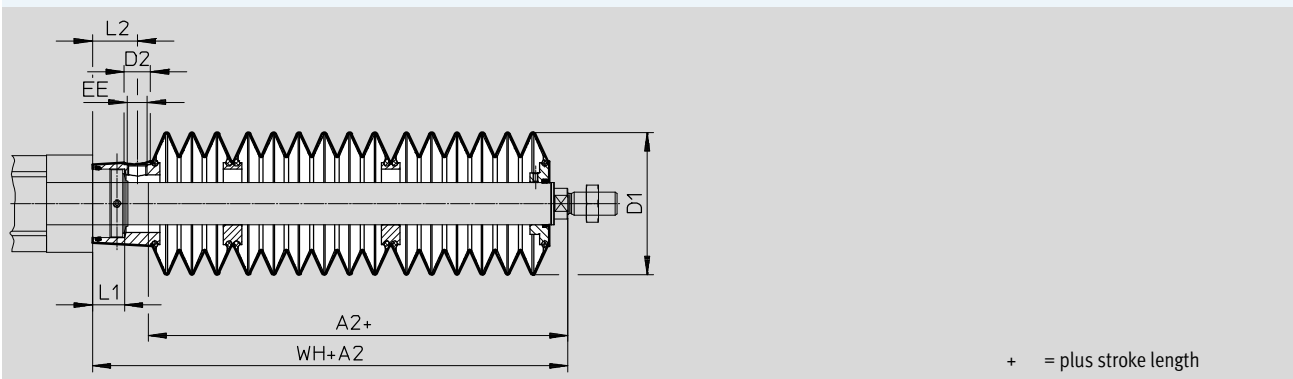

Ø Stroke [mm]	32							40						
	A2 ¹⁾	D1 Max.	D2	EE	L1	L2	WH+A2	A2 ¹⁾	D1 Max.	D2	EE	L1	L2	WH+A2
10 ... 100	52	57	17	G $\frac{1}{4}$	15	23.3	76.5	50	57	17	G $\frac{1}{4}$	15	23.3	79.5
101 ... 200	81						105.5	79						108.5
201 ... 300	92						116.5	90						119.5
301 ... 400	121						145.5	119						148.5
401 ... 500	139						162.5	137						166.5

Ø Stroke [mm]	50						
	A2 ¹⁾	D1 Max.	D2	EE	L1	L2	WH+A2
10 ... 100	46	93	17	G $\frac{1}{4}$	21	29.4	81.5
101 ... 200	70						106.5
201 ... 300	82						118.5
301 ... 400	107						142.5
401 ... 500	119						155.5

1) The dimension corresponds to the E value (piston rod extension) of the cylinder

Electric cylinders ESBF, with spindle drive

Accessories

Dimensions

Download CAD data → www.festo.com

For size 63, 80

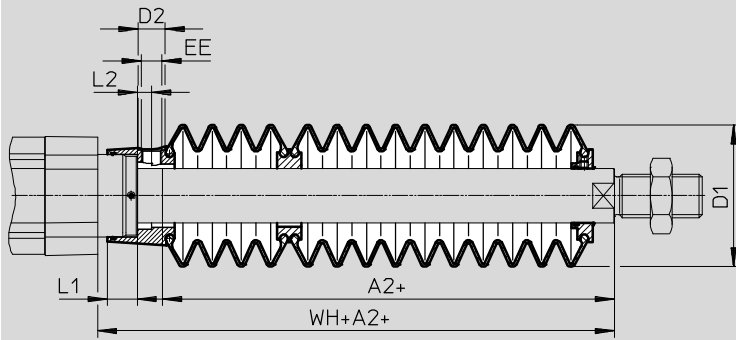

+ = plus stroke length

Ø Stroke [mm]	63						
	A2 ¹⁾	D1 Max.	D2	EE	L1	L2	WH+A2
10 ... 100	45	93	17	G1/4	18.9	9	82
101 ... 200	70						107
201 ... 300	82						119
301 ... 400	106						143
401 ... 500	119						156

Ø Stroke [mm]	80						
	A2 ¹⁾	D1 Max.	D2	EE	L1	L2	WH+A2
10 ... 100	48	93	17	G1/4	21.9	12	94
101 ... 200	73						119
201 ... 300	85						131
301 ... 400	109						155
401 ... 500	122						168

1) The dimension corresponds to the E value (piston rod extension) of the cylinder

Electric cylinders ESBF, with spindle drive

Accessories

Ordering data – Protective bellows kit

An extended piston rod (order code ...E) → 24 is absolutely essential if a protective bellows kit is to be used.

The necessary dimensions for ...E as a function of cylinder size and stroke as well as the corresponding protective bellows kit are indicated in the following table:

Order example:

Selected electric cylinder:

ESBF-BS-63-250-5P-...E

The dimension for the corresponding E value (see table):

82 mm

Complete type code for electric cylinder:

ESBF-BS-63-250-5P-82E

The corresponding protective bellows kit:

EADB-V2-63-S201-300

Cylinder data			Protective bellows kit	
∅ [mm]	Stroke [mm]	Dimension for ...E [mm]	Part No.	Type
32	10 ... 100	52	2828829	EADB-V2-32-S10-100
	101 ... 200	81	2828830	EADB-V2-32-S101-200
	201 ... 300	92	2828831	EADB-V2-32-S201-300
	301 ... 400	121	2828832	EADB-V2-32-S301-400
	401 ... 500	139	2828833	EADB-V2-32-S401-500
40	10 ... 100	50	2828834	EADB-V2-40-S10-100
	101 ... 200	79	2828835	EADB-V2-40-S101-200
	201 ... 300	90	2828836	EADB-V2-40-S201-300
	301 ... 400	119	2828837	EADB-V2-40-S301-400
	401 ... 500	137	2828838	EADB-V2-40-S401-500
50	10 ... 100	46	2828839	EADB-V2-50-S10-100
	101 ... 200	70	2828840	EADB-V2-50-S101-200
	201 ... 300	82	2828841	EADB-V2-50-S201-300
	301 ... 400	107	2828842	EADB-V2-50-S301-400
	401 ... 500	119	2828843	EADB-V2-50-S401-500
63	10 ... 100	45	1488361	EADB-V2-63-S10-100
	101 ... 200	70	1488362	EADB-V2-63-S101-200
	201 ... 300	82	1488363	EADB-V2-63-S201-300
	301 ... 400	106	1488364	EADB-V2-63-S301-400
	401 ... 500	119	1488365	EADB-V2-63-S401-500
80	10 ... 100	48	1489406	EADB-V2-80-S10-100
	101 ... 200	73	1489407	EADB-V2-80-S101-200
	201 ... 300	85	1489408	EADB-V2-80-S201-300
	301 ... 400	109	1489409	EADB-V2-80-S301-400
	401 ... 500	122	1489410	EADB-V2-80-S401-500

Electric cylinders ESBF, with spindle drive

Accessories

Profile mounting EAHF

Materials:

RoHS compliant

Plate: Anodised aluminium

Clamping piece: Coated steel

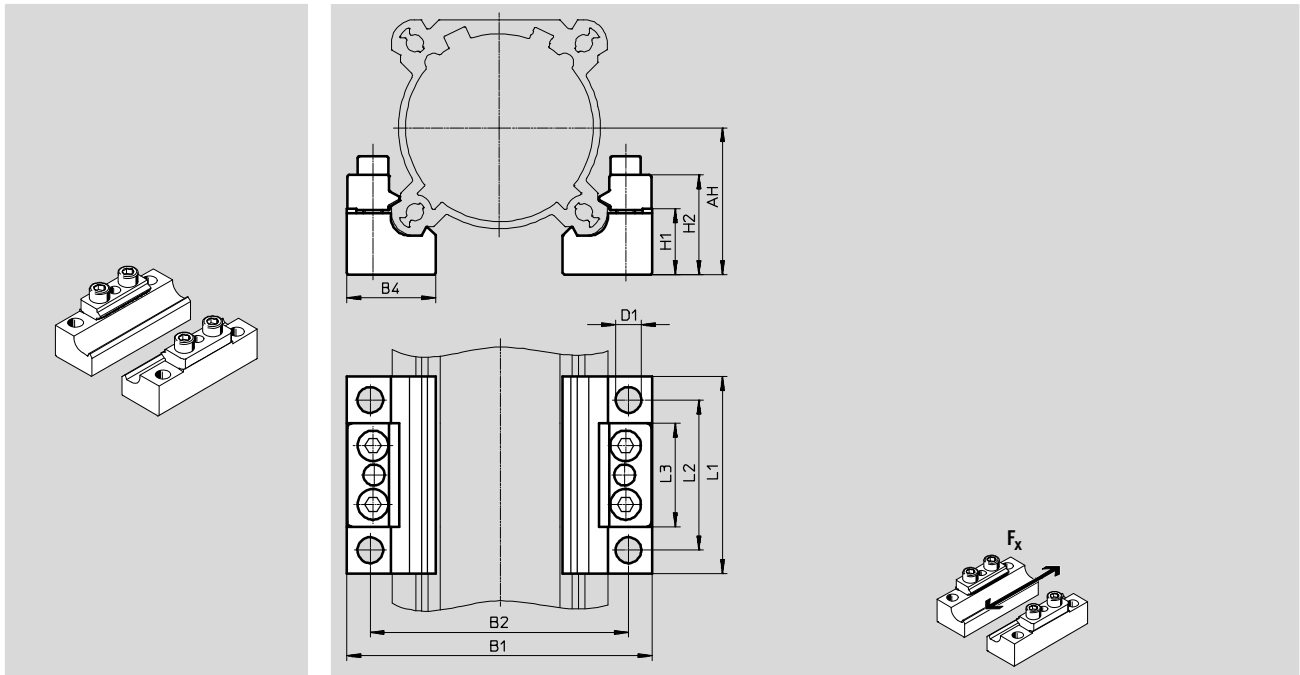

Dimensions and ordering data

For size	AH	B1	B2	B4	D1	H1	H2	L1	L2	L3
[mm]					∅					
32	32	76	60	26	9	16	23.6	80	60	34
40	36	84.5	68	26	9	16	23.6	80	60	34
50	44.5	94	81	30	9	22.8	30.4	80	60	41
63	50	105	92	30	9	22.8	30.4	80	60	41
80	62.5	130	110	38	11	28.1	42.5	84	64	44
100	71	147	127	38	11	28.1	42.5	84	64	44

For size	Transferable axial force F_x	CRC ¹⁾	Weight	Part No.	Type
[mm]	[kN]		[g]		
32, 40	1.6	3	218	2838839	EAHF-V2-32/40-P
50, 63	3.6	3	340	1547781	EAHF-V2-50/63-P
80, 100	4.0	3	570	1547780	EAHF-V2-80/100-P

1) Corrosion resistance class CRC 3 to Festo standard FN 940070

High corrosion stress. Outdoor exposure under moderate corrosive conditions. External visible parts with primarily functional requirements for the surface and which are in direct contact with a normal industrial environment.

New
Sizes: 32, 40, 50

Electric cylinders ESBF, with spindle drive

Accessories

FESTO

**Foot mounting HNC/CRHNC,
for parallel motor attachment**

Materials:
HNC: Galvanised steel

CRHNC: High-alloy steel
Free of copper and PTFE

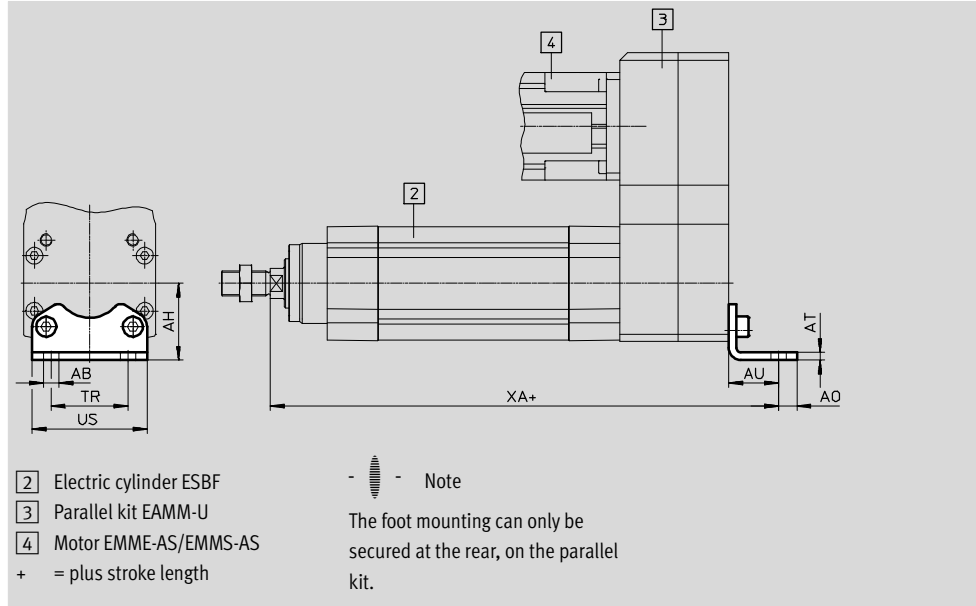

Dimensions and ordering data							
For size	AB ∅	AH	AO	AT	AU	TR	US
[mm]					±0.2	JS14	
32	7	32	6.5	4	24	32	45-0.5
40	10	36	9	4	28	36	54-0.6
50	10	45	9.5	5	32	45	64-0.6
63	10	50	12.5	5	32	50	75-0.6
80	12	63	15	6	41	63	93-0.8
100	14.5	71	17.5	6	41	75	110-0.8

For size [mm]	XA With parallel kit					
	EAMM-U-50	EAMM-U-60	EAMM-U-70	EAMM-U-86	EAMM-U-110	EAMM-U-145
32	217	228	236.5	–	–	–
40	–	257.5	266	270.5	–	–
50	–	–	298	302.5	313.5	–
63	–	–	–	311	322	–
80	–	–	–	–	373	390.5
100	–	–	–	–	–	415.5

For size [mm]	Max. load carrying ability [kN]	ESBF-...				ESBF-...-R3			
		CRC ¹⁾	Weight [g]	Part No.	Type	CRC ¹⁾	Weight [g]	Part No.	Type
32	0.9	2	144	174369	HNC-32	4	139	176937	CRHNC-32
40	1.5	2	193	174370	HNC-40	4	188	176938	CRHNC-40
50	2.5	2	353	174371	HNC-50	4	341	176939	CRHNC-50
63	4	2	436	174372	HNC-63	4	424	176940	CRHNC-63
80	6	2	829	174373	HNC-80	4	810	176941	CRHNC-80
100	9	2	1009	174374	HNC-100	4	990	176942	CRHNC-100

1) Corrosion resistance class CRC 2 to Festo standard FN 940070
Moderate corrosion stress. Indoor applications in which condensation may occur. External visible parts with primarily decorative requirements for the surface and which are in direct contact with the ambient atmosphere typical for industrial applications.
Corrosion resistance class CRC 4 to Festo standard FN 940070
Particularly high corrosion stress. Outdoor exposure under extreme corrosive conditions. Parts exposed to aggressive media, for instance in the chemical or food industries. These applications may need to be supported by special tests (→ also FN 940082) using appropriate media.

Electric cylinders ESBF, with spindle drive

Accessories

Flange mounting EAHH

Materials:
 High-alloy stainless steel

RoHS compliant
 Free of copper and PTFE

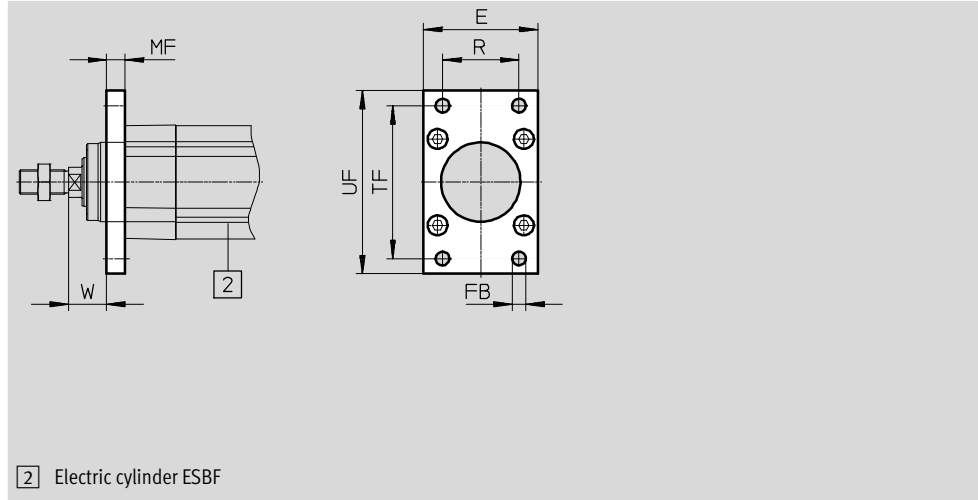

2 Electric cylinder ESBF

Dimensions and ordering data

For size	E	FB ∅ H13	MF js14	R	TF	UF ±1	W
[mm]							
32	45	7	10	32	64	80	15.5
40	54	9	10	36	72	90	19.5
50	64	9	12	45	90	110	24.5
63	75	9	12	50	100	120	25
80	93	12	16	63	126	150	30
100	110	14	16	75	150	175	35

For size	Max. load carrying ability	ESBF...-R3		
		CRC ¹⁾	Weight	Part No. Type
[mm]	[kN]		[g]	
32	1	4	206	2827587 EAHH-V2-32-R1
40	3	4	275	2827588 EAHH-V2-40-R1
50	5	4	496	2827589 EAHH-V2-50-R1
63	7	4	633	1502305 EAHH-V2-63-R1
80	12	4	1360	1502306 EAHH-V2-80-R1
100	17	4	1880	1502307 EAHH-V2-100-R1

1) Corrosion resistance class CRC 4 to Festo standard FN 940070
 Particularly high corrosion stress. Outdoor exposure under extreme corrosive conditions. Parts exposed to aggressive media, for instance in the chemical or food industries. These applications may need to be supported by special tests (→ also FN 940082) using appropriate media.

New
Sizes: 32, 40, 50

Electric cylinders ESBF, with spindle drive

Accessories

FESTO

Trunnion flange ZNCF/CRZNG

Materials:

ZNCF: Stainless steel casting

CRZNG: Electropolished stainless steel casting

Free of copper and PTFE

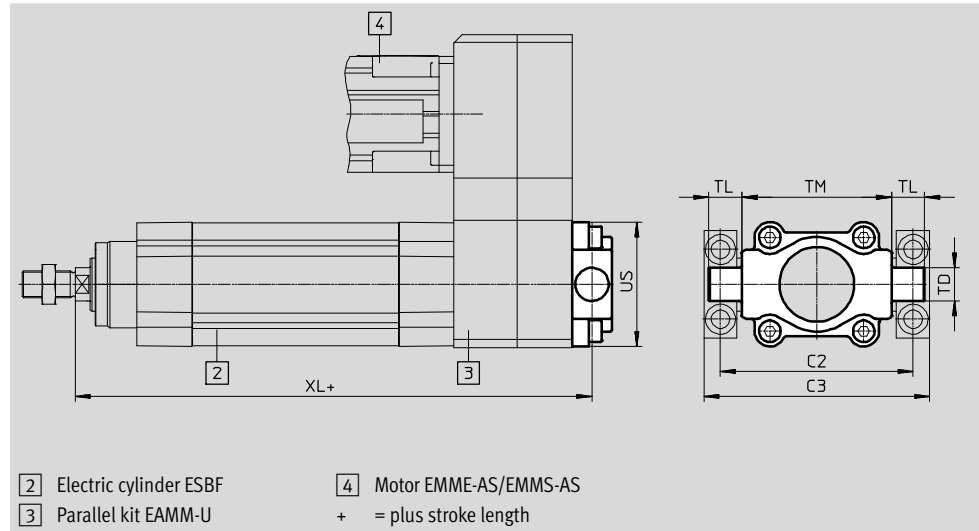

2 Electric cylinder ESBF
 3 Parallel kit EAMM-U
 4 Motor EMME-AS/EMMS-AS
 + = plus stroke length

Dimensions and ordering data

For size	C2	C3	TD Ø	TL	TM	US
[mm]			e9		H14	
32	71	86	12	12 _{h14}	50	45
40	87	105	16	16 _{h14}	63	54
50	99	117	16	16 _{h14}	75	64
63	116	136	20	20 _{+0,5/-0,7}	90	75
80	136	156	20	19.5 _{+0,5/-0,7}	110	93
100	164	189	25	24.5 _{+0,5/-0,7}	132	110

For size	XL					
	With parallel kit					
[mm]	EAMM-U-50	EAMM-U-60	EAMM-U-70	EAMM-U-86	EAMM-U-110	EAMM-U-145
32	201	212	220.5	–	–	–
40	–	239.5	248	252.5	–	–
50	–	–	278	282.5	293.5	–
63	–	–	–	291	302	–
80	–	–	–	–	346	363.5
100	–	–	–	–	–	393.5

For size	Max. load carrying ability [kN]	ESBF-...				ESBF-...-R3			
		CRC ¹⁾	Weight [g]	Part No.	Type	CRC ¹⁾	Weight [g]	Part No.	Type
32	0.9	2	150	174411	ZNCF-32	4	150	161852	CRZNG-32
40	1.5	2	285	174412	ZNCF-40	4	285	161853	CRZNG-40
50	2.5	2	473	174413	ZNCF-50	4	473	161854	CRZNG-50
63	4	2	687	174414	ZNCF-63	4	687	161855	CRZNG-63
80	6	2	1296	174415	ZNCF-80	4	1296	161856	CRZNG-80
100	9	2	2254	174416	ZNCF-100	4	2254	161857	CRZNG-100

1) Corrosion resistance class CRC 2 to Festo standard FN 940070

Moderate corrosion stress. Indoor applications in which condensation may occur. External visible parts with primarily decorative requirements for the surface and which are in direct contact with the ambient atmosphere typical for industrial applications.

Corrosion resistance class CRC 4 to Festo standard FN 940070

Particularly high corrosion stress. Outdoor exposure under extreme corrosive conditions. Parts exposed to aggressive media, for instance in the chemical or food industries. These applications may need to be supported by special tests (→ also FN 940082) using appropriate media.

Electric cylinders ESBF, with spindle drive

Accessories

Trunnion support LNZG

Materials:

Trunnion support: Anodised aluminium

Plain bearing: Plastic

Free of copper and PTFE

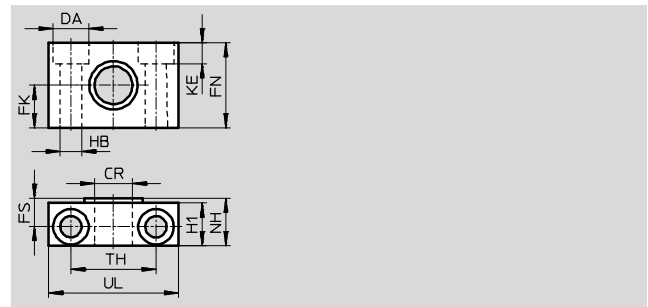
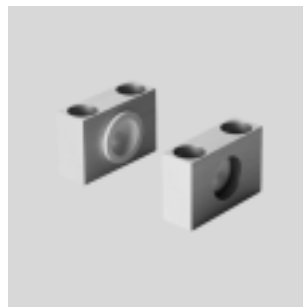

Dimensions and ordering data

For size [mm]	Max. load carrying ability [kN]	CR ∅	DA ∅	FK ±0.1	FN	FS	H1	HB ∅
32	0.9	D11	H13					H13
32	0.9	12	11	15	30	10.5	15	6.6
40, 50	2.5	16	15	18	36	12	18	9
63, 80	6	20	18	20	40	13	20	11
100	9	25	20	25	50	16	24.5	14

For size [mm]	KE	NH	TH ±0.2	UL	CRC ¹⁾	Weight [g]	Part No.	Type
32	6.8	18	32	46	2	83	32959	LNZG-32
40, 50	9	21	36	55	2	129	32960	LNZG-40/50
63, 80	11	23	42	65	2	178	32961	LNZG-63/80
100	13	28.5	50	75	2	306	32962	LNZG-100/125

1) Corrosion resistance class CRC 2 to Festo standard FN 940070

Moderate corrosion stress. Indoor applications in which condensation may occur. External visible parts with primarily decorative requirements for the surface and which are in direct contact with the ambient atmosphere typical for industrial applications.

New
Sizes: 32, 40, 50

Electric cylinders ESBF, with spindle drive

Accessories

FESTO

Trunnion support CRLNZG

Materials:

High-alloy steel

Free of copper and PTFE

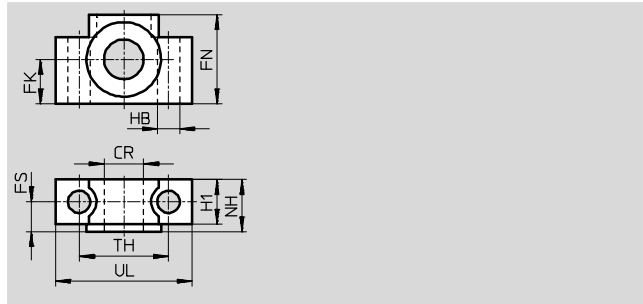
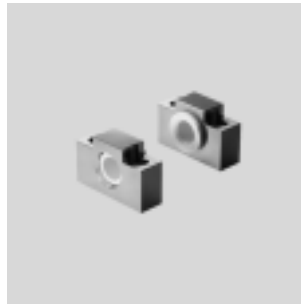

Dimensions and ordering data							
For size	Max. load carrying ability	CR	FK	FN	FS	H1	HB
[mm]	[kN]	∅	±0.1				∅
		D11					H13
32	0.9	12	15	30	10.5	15	6.6
40/50	2.5	16	18	36	12	18	9
63, 80	6	20	20	40	13	20	11
100	9	25	25	50	16	24.5	14

For size	NH	TH	UL	CRC ¹⁾	Weight	Part No.	Type
[mm]		±0.2			[g]		
32	18	32	46	4	205	161874	CRLNZG-32
40/50	21	36	55	4	323	161875	CRLNZG-40/50
63, 80	23	42	65	4	435	161876	CRLNZG-63/80
100	28.5	50	75	4	739	161877	CRLNZG-100/125

1) Corrosion resistance class CRC 4 to Festo standard FN 940070
 Particularly high corrosion stress. Outdoor exposure under extreme corrosive conditions. Parts exposed to aggressive media, for instance in the chemical or food industries. These applications may need to be supported by special tests (→ also FN 940082) using appropriate media.

Electric cylinders ESBF, with spindle drive

Accessories

Swivel flange DAMS

Materials:
 Aluminium

RoHS compliant
 Free of copper and PTFE

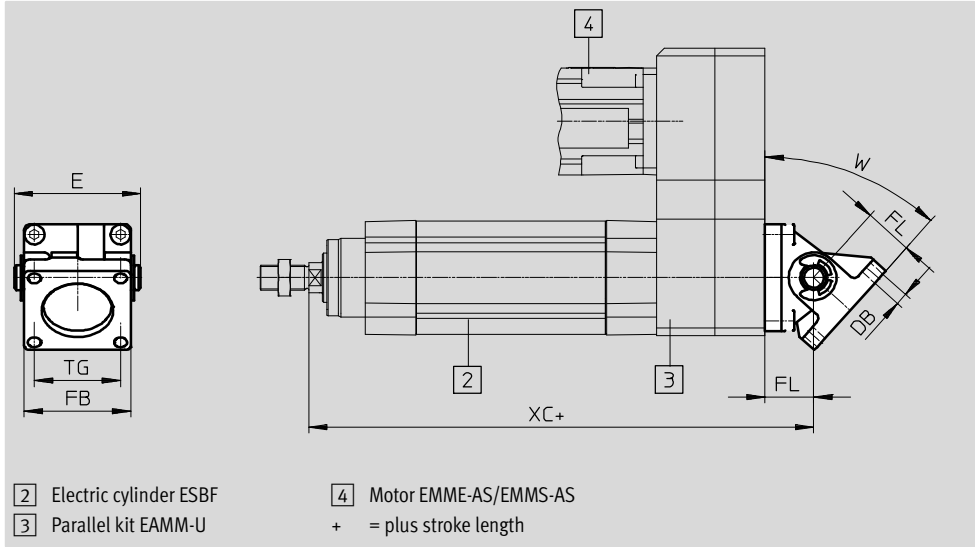

Dimensions and ordering data						
For size	DB ∅	E	FB	FL	TG	W Max. [°]
[mm]						
40	6.5	63	52	25	38	32
50	8.5	73	60	27	46.5	45
63	8.5	83	70	32	56.5	42
80	10.5	103	90	36	72	31
100	10.5	127	110	41	89	36

For size	XC				
	With parallel kit				
[mm]	EAMM-U-60	EAMM-U-70	EAMM-U-86	EAMM-U-110	EAMM-U-145
40	254.5	263	267.5	-	-
50	-	293	297.5	308.5	-
63	-	-	311	322	-
80	-	-	-	368	385.5
100	-	-	-	-	415.5

For size	Max. load carrying ability	CRC ¹⁾	Weight	Part No.	Type
[mm]	[kN]		[g]		
40	3	3	258	2787470	DAMS-K-V1-40-V-R3
50	5	3	451	2787651	DAMS-K-V1-50-V-R3
63	7	3	657	1555443	DAMS-K-V1-63-V-R3
80	12	3	1240	1556588	DAMS-K-V1-80-V-R3
100	17	3	1940	1560237	DAMS-K-V1-100-V-R3

1) Corrosion resistance class CRC 3 to Festo standard FN 940070
 High corrosion stress. Outdoor exposure under moderate corrosive conditions. External visible parts with primarily functional requirements for the surface and which are in direct contact with a normal industrial environment.

Note
 The swivel flange SNCS or SNCB (max. load carrying ability of 1 kN) can be used for size 32.

New
Sizes: 32, 40, 50

Electric cylinders ESBF, with spindle drive

Accessories

FESTO

Swivel flange SNC

Materials:
 Die-cast aluminium

Free of copper and PTFE
 RoHS compliant

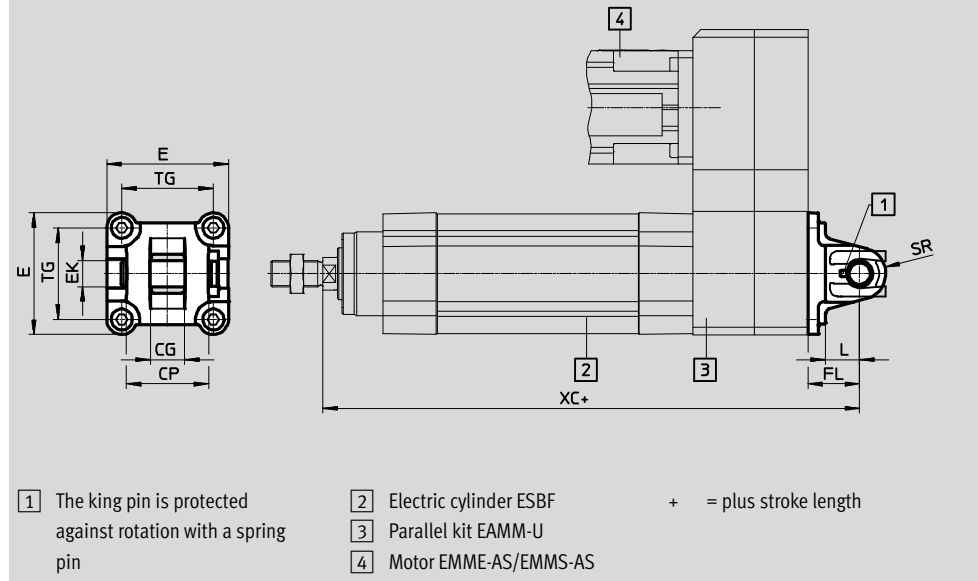

Dimensions and ordering data

For size	CG	CP	E	EK	FL	L	SR	TG
[mm]	H14	H14		∅ H9	±0.2			
32	14	34	45 ^{+0.2/-0.5}	10	22	13	10	32.5
40	16	40	54 ^{-0.5}	12	25	16	12	38
50	21	45	64 ^{-0.6}	16	27	16	12	46.5
63	21	51	75 ^{-0.6}	16	32	21	16	56.5
80	25	65	93 ^{-0.8}	20	36	22	16	72
100	25	75	110 ^{+0.3/-0.8}	20	41	27	20	89

For size	XC					
	With parallel kit					
[mm]	EAMM-U-50	EAMM-U-60	EAMM-U-70	EAMM-U-86	EAMM-U-110	EAMM-U-145
32	215	226	234.5	–	–	–
40	–	254.5	263	267.5	–	–
50	–	–	293	297.5	308.5	–
63	–	–	–	311	322	–
80	–	–	–	–	368	385.5
100	–	–	–	–	–	415.5

For size	Max. load carrying ability	CRC ¹⁾	Weight	Part No.	Type
[mm]	[kN]		[g]		
32	0.9	2	93	174383	SNC-32
40	1.5	2	140	174384	SNC-40
50	2.5	2	234	174385	SNC-50
63	4	2	331	174386	SNC-63
80	6	2	618	174387	SNC-80
100	9	2	865	174388	SNC-100

1) Corrosion resistance class CRC 2 to Festo standard FN 940070
 Moderate corrosion stress. Indoor applications in which condensation may occur. External visible parts with primarily decorative requirements for the surface and which are in direct contact with the ambient atmosphere typical for industrial applications.

Electric cylinders ESBF, with spindle drive

Accessories

Swivel flange SNCS

Materials:

SNCS 63 ... 80: Die-cast aluminium

SNCS 100: Wrought aluminium alloy

Free of copper and PTFE

RoHS compliant

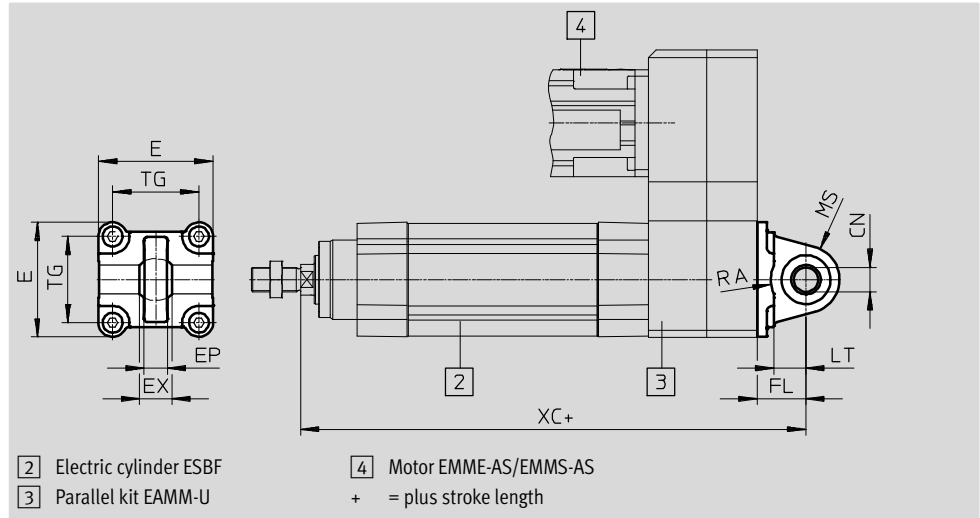
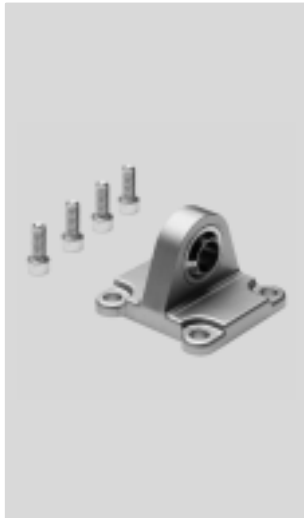

2 Electric cylinder ESBF
 3 Parallel kit EAMM-U

4 Motor EMME-AS/EMMS-AS
 + = plus stroke length

Dimensions and ordering data

For size	CN Ø	E	EP	EX	FL	LT	MS	RA	TG
[mm]			±0.2		±0.2			+1	
32	10 ^{+0,013}	45 ^{+0,2/-0,5}	10.5	14	22	13	15 ^{+0,5}	14.5	32.5
40	12 ^{+0,015}	54 _{-0,5}	12	16	25	16	17 ^{+0,5}	17.5	38
50	16 ^{+0,015}	64 _{-0,6}	15	21	27	16	20 ^{+0,5}	18.5	46.5
63	16 ^{+0,015}	75 _{-0,6}	15	21	32	21	23 _{-0,5}	23	56.5
80	20 ^{+0,018}	93 _{-0,8}	18	25	36	22	28 _{-0,5}	25	72
100	20 ^{+0,018}	109 ^{+1/-0,7}	18	25	41	27	30 ^{+0,5}	95	89

For size	XC With parallel kit					
	EAMM-U-50	EAMM-U-60	EAMM-U-70	EAMM-U-86	EAMM-U-110	EAMM-U-145
[mm]						
32	215	226	234.5	–	–	–
40	–	254.5	263	267.5	–	–
50	–	–	293	297.5	308.5	–
63	–	–	–	311	322	–
80	–	–	–	–	368	385.5
100	–	–	–	–	–	415.5

For size	Max. load carrying ability	CRC ¹⁾	Weight	Part No.	Type
[mm]	[kN]		[g]		
32	1	2	86	174397	SNCS-32
40	1.5	2	122	174398	SNCS-40
50	2.5	2	216	174399	SNCS-50
63	4	2	281	174400	SNCS-63
80	6	2	557	174401	SNCS-80
100	9	2	683	174402	SNCS-100

1) Corrosion resistance class CRC 2 to Festo standard FN 940070

Moderate corrosion stress. Indoor applications in which condensation may occur. External visible parts with primarily decorative requirements for the surface and which are in direct contact with the ambient atmosphere typical for industrial applications.

New
Sizes: 32, 40, 50

Electric cylinders ESBF, with spindle drive

Accessories

FESTO

Swivel flange SNCL

Materials:
 Die-cast aluminium

Free of copper and PTFE
 RoHS compliant

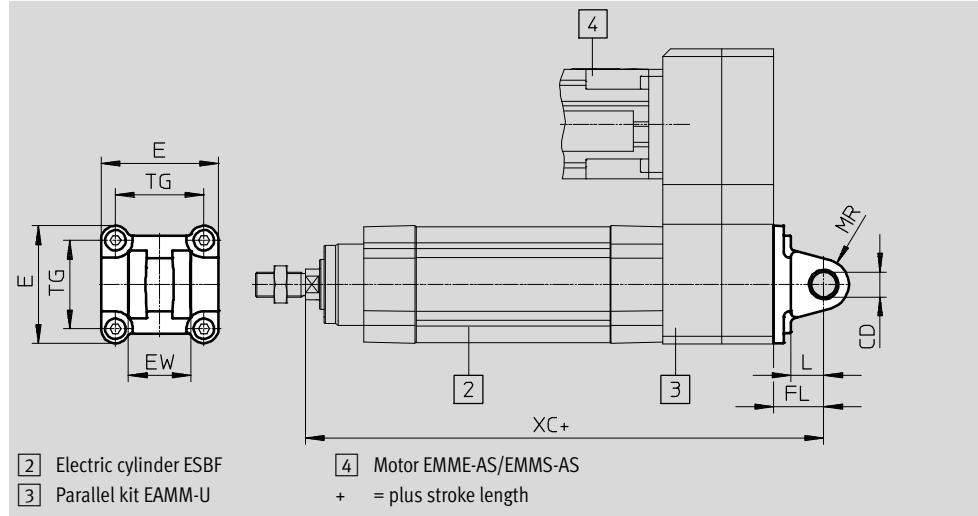

Dimensions and ordering data							
For size	CD	E	EW	FL	L	MR	TG
[mm]	∅ H9		-0.2/-0.6	±0.2			
32	10	45 ^{+0.2/-0.5}	26	22	13	10	32.5
40	12	54 ^{-0.5}	28	25	16	12	38
50	12	64 ^{-0.6}	32	27	16	12	46.5
63	16	75 ^{-0.6}	40	32	21	16	56.5
80	16	93 ^{-0.8}	50	36	22	16	72
100	20	110 ^{+0.3/-0.8}	60	41	27	20	89

For size	XC					
	With parallel kit					
[mm]	EAMM-U-50	EAMM-U-60	EAMM-U-70	EAMM-U-86	EAMM-U-110	EAMM-U-145
32	215	226	234.5	-	-	-
40	-	254.5	263	267.5	-	-
50	-	-	293	297.5	308.5	-
63	-	-	-	311	322	-
80	-	-	-	-	368	385.5
100	-	-	-	-	-	415.5

For size	Max. load carrying ability	CRC ¹⁾	Weight	Part No.	Type
[mm]	[kN]		[g]		
32	0.9	2	71	174404	SNCL-32
40	1.5	2	95	174405	SNCL-40
50	2.5	2	158	174406	SNCL-50
63	4	2	225	174407	SNCL-63
80	6	2	436	174408	SNCL-80
100	9	2	606	174409	SNCL-100

1) Corrosion resistance class CRC 2 to Festo standard FN 940070
 Moderate corrosion stress. Indoor applications in which condensation may occur. External visible parts with primarily decorative requirements for the surface and which are in direct contact with the ambient atmosphere typical for industrial applications.

Electric cylinders ESBF, with spindle drive

Accessories

Swivel flange
SNCB/SNCB-...-R3

Materials:
 SNCB: Die-cast aluminium
 SNCB-...-R3: Die-cast aluminium with
 protective coating, high corrosion
 protection

Free of copper and PTFE
 RoHS compliant

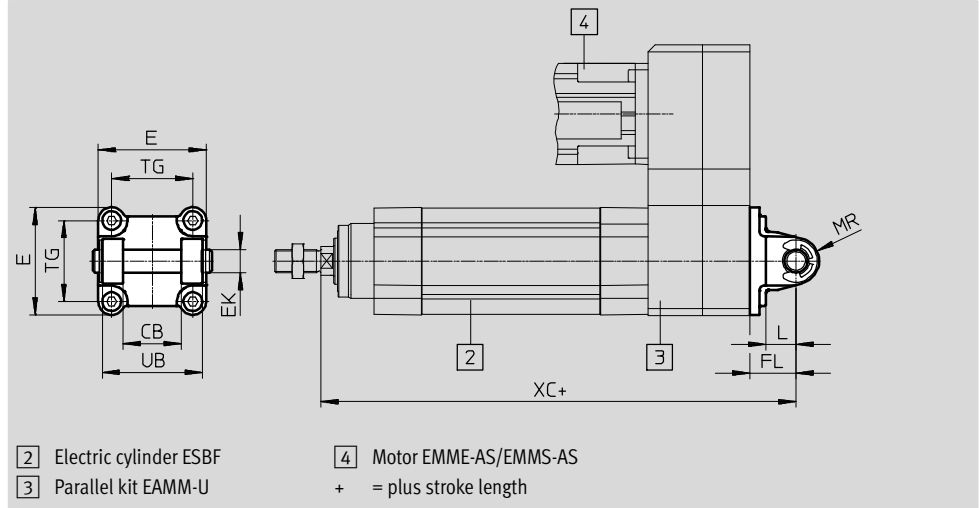

Dimensions and ordering data								
For size	CB	E	EK ∅	FL	L	MR	TG	UB
[mm]	H14		e8	±0.2		-0.5		H14
32	26	45 ^{+0,2/-0,5}	10	22	13	8.5	32.5	45
40	28	54 ^{-0,5}	12	25	16	12	38	52
50	32	64 ^{-0,6}	12	27	16	12	46.5	60
63	40	75 ^{-0,6}	16	32	21	16	56.5	70
80	50	93 ^{-0,8}	16	36	22	16	72	90
100	60	110 ^{+0,3/-0,8}	20	41	27	20	89	110

For size [mm]	XC With parallel kit					
	EAMM-U-50	EAMM-U-60	EAMM-U-70	EAMM-U-86	EAMM-U-110	EAMM-U-145
32	215	226	234.5	-	-	-
40	-	254.5	263	267.5	-	-
50	-	-	293	297.5	308.5	-
63	-	-	-	311	322	-
80	-	-	-	-	368	385.5
100	-	-	-	-	-	415.5

For size [mm]	Max. load carrying ability [kN]	ESBF-...				ESBF-...-R3			
		CRC ¹⁾	Weight [g]	Part No.	Type	CRC ¹⁾	Weight [g]	Part No.	Type
32	1	2	103	174390	SNCB-32	3	100	176944	SNCB-32-R3
40	1.5	2	155	174391	SNCB-40	3	151	176945	SNCB-40-R3
50	2.5	2	232	174392	SNCB-50	3	228	176946	SNCB-50-R3
63	4	2	375	174393	SNCB-63	3	371	176947	SNCB-63-R3
80	6	2	636	174394	SNCB-80	3	632	176948	SNCB-80-R3
100	9	2	1035	174395	SNCB-100	3	986	176949	SNCB-100-R3

1) Corrosion resistance class CRC 2 to Festo standard FN 940070
 Moderate corrosion stress. Indoor applications in which condensation may occur. External visible parts with primarily decorative requirements for the surface and which are in direct contact with the ambient atmosphere typical for industrial applications.
 Corrosion resistance class CRC 3 to Festo standard FN 940070
 High corrosion stress. Outdoor exposure under moderate corrosive conditions. External visible parts with primarily functional requirements for the surface and which are in direct contact with a normal industrial environment.

New
Sizes: 32, 40, 50

Electric cylinders ESBF, with spindle drive

Accessories



Trunnion mounting kit DAMT

Materials:
 Galvanised steel

Free of copper and PTFE
 RoHS compliant

The kit can be mounted at any position along the cylinder profile barrel. The trunnion mounting kit cannot be

mounted in the vicinity of the motor when used in combination with the parallel kit EAMM-U.

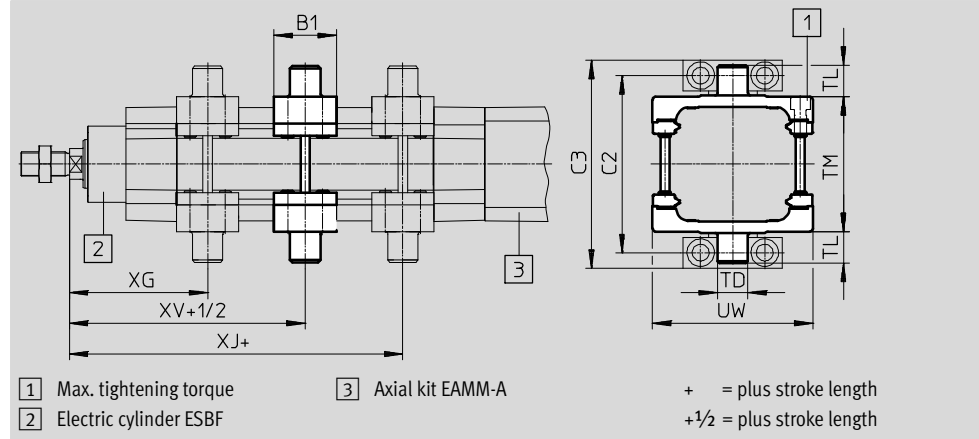



Dimensions and ordering data								
For size	B1	C2	C3	TD	TL	TM	UW	XG
[mm]				∅ e9				
32	30	71	86	12	12	50	65	66
40	32	87	105	16	16	63	75	75.5
50	34	99	117	16	16	75	95	83.5
63	41	116	136	20	20	90	105	90.5
80	44	136	156	20	20	110	130	107
100	48	164	189	25	25	132	145	114

For size	XJ	XV	Max. tightening torque	Max. load carrying ability	CRC ¹⁾	Weight	Part No.	Type
[mm]			[Nm]	[kN]		[g]		
32	107.5	86.8	4+1	0.9	1	212.7	2213233	DAMT-V1-32-A
40	127.5	101.5	8+1	1.5	1	387.5	2214899	DAMT-V1-40-A
50	152.5	118	8+2	2.5	1	607.6	2214909	DAMT-V1-50-A
63	154.5	122.5	18+2	4	1	910.5	2214971	DAMT-V1-63-A
80	189	148	28+2	6	1	1493.7	163529	DAMT-V1-80-A
100	212	163	28+2	9	1	2094.8	163530	DAMT-V1-100-A

1) Corrosion resistance class CRC 1 to Festo standard FN 940070
 Low corrosion stress. For dry indoor applications or transport and storage protection. Also applies to parts behind covers, in the non-visible interior area, and parts which are covered in the application (e.g. drive trunnions).

Electric cylinders ESBF, with spindle drive

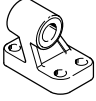
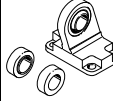
Accessories

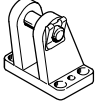
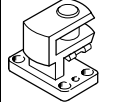
Ordering data – Mounting attachments					Technical data → Internet: clevis foot				
Designation	For size	Max. load carrying ability [kN]	Part No.	Type	Designation	For size	Max. load carrying ability [kN]	Part No.	Type
Clevis foot LNG					Clevis foot LSN				
	32	0.9	33890	LNG-32		32	0.9	5561	LSN-32
	40	1.5	33891	LNG-40		40	1.5	5562	LSN-40
	50	2.5	33892	LNG-50		50	2.5	5563	LSN-50
	63	4	33893	LNG-63		63	4	5564	LSN-63
	80	6	33894	LNG-80		80	6	5565	LSN-80
	100	9	33895	LNG-100		100	9	5566	LSN-100
Clevis foot LSNG					Clevis foot LSNSG				
	32	0.9	31740	LSNG-32		32	0.9	31747	LSNSG-32
	40	1.5	31741	LSNG-40		40	1.5	31748	LSNSG-40
	50	2.5	31742	LSNG-50		50	2.5	31749	LSNSG-50
	63	4	31743	LSNG-63		63	4	31750	LSNSG-63
	80	6	31744	LSNG-80		80	6	31751	LSNSG-80
	100	9	31745	LSNG-100		100	9	31752	LSNSG-100
Clevis foot LBG					Right-angle clevis foot LQG				
	32	0.9	31761	LBG-32		32	0.9	31768	LQG-32
	40	1.5	31762	LBG-40		40	1.5	31769	LQG-40
	50	2.5	31763	LBG-50		50	2.5	31770	LQG-50
	63	4	31764	LBG-63		63	4	31771	LQG-63
	80	6	31765	LBG-80		80	6	31772	LQG-80
	100	9	31766	LBG-100		100	9	31773	LQG-100

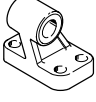



Ordering data – Mounting attachments, corrosion-resistant				Technical data → Internet: clevis foot	
Designation	For size	Max. load carrying ability [kN]	Part No.	Type	
Clevis foot CRLNG					
	32	0.9	161840	CRLNG-32	
	40	1.5	161841	CRLNG-40	
	50	2.5	161842	CRLNG-50	
	63	4	161843	CRLNG-63	
	80	6	161844	CRLNG-80	
	100	9	161845	CRLNG-100	



 **New**
Sizes: 32, 40, 50

Electric cylinders ESBF, with spindle drive

Accessories

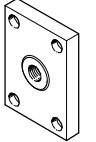
FESTO

Ordering data – Piston-rod attachments					Technical data → Internet: piston-rod attachment				
Designation	For size	Max. load carrying ability [kN]	Part No.	Type	Designation	For size	Max. load carrying ability [kN]	Part No.	Type
Rod eye SGS					Rod clevis SGA				
	32	0.9	9261	SGS-M10x1,25		32	0.9	32954	SGA-M10x1,25
	40	1.5	9262	SGS-M12x1,25		40	1.5	10767	SGA-M12x1,25
	50, 63	4	9263	SGS-M16x1,5		50, 63	4	10768	SGA-M16x1,5
	80, 100	9	9264	SGS-M20x1,5		80, 100	9	10769	SGA-M20x1,5
Rod clevis SG					Self-aligning rod coupler FK				
	32	0.9	6144	SG-M10x1,25		32	0.9	6140	FK-M10x1,25
	40	1.5	6145	SG-M12x1,25		40	1.5	6141	FK-M12x1,25
	50, 63	4	6146	SG-M16x1,5		50, 63	4	6142	FK-M16x1,5
	80, 100	9	6147	SG-M20x1,5		80, 100	9	6143	FK-M20x1,5
Coupling piece KSZ									
	32	0.9	36125	KSZ-M10x1,25					
	40	1.5	36126	KSZ-M12x1,25					
	50, 63	4	36127	KSZ-M16x1,5					
	80, 100	9	36128	KSZ-M20x1,5					

Ordering data – Piston-rod attachments, corrosion-resistant					Technical data → Internet: piston-rod attachment				
Designation	For size	Max. load carrying ability [kN]	Part No.	Type	Designation	For size	Max. load carrying ability [kN]	Part No.	Type
Rod eye CRSGS					Rod clevis CRSG				
	32	0.9	195582	CRSGS-M10x1,25		32	0.9	13569	CRSG-M10x1,25
	40	1.5	195583	CRSGS-M12x1,25		40	1.5	13570	CRSG-M12x1,25
	50, 63	4	195584	CRSGS-M16x1,5		50, 63	4	13571	CRSG-M16x1,5
	80, 100	9	195585	CRSGS-M20x1,5		80, 100	9	13572	CRSG-M20x1,5
Self-aligning rod coupler CRFK									
	32	0.9	2305778	CRFK-M10x1,25					
	40	1.5	2305779	CRFK-M12x1,25					
	50, 63	4	2490673	CRFK-M16x1,5					
	80, 100	9	2545677	CRFK-M20x1,5					

Electric cylinders ESBF, with spindle drive

Accessories

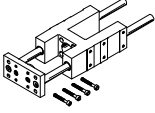
Ordering data – Guide units				Technical data → Internet: eagf			
	Stroke [mm]	Part No.	Type	Stroke [mm]	Part No.	Type	
	For size 32			For size 40			
	10 ... 100	2782679	EAGF-V2-KF-32-100	10 ... 100	2782939	EAGF-V2-KF-40-100	
	10 ... 200	2782818	EAGF-V2-KF-32-200	10 ... 200	2782976	EAGF-V2-KF-40-200	
	10 ... 320	2782885	EAGF-V2-KF-32-320	10 ... 320	2783047	EAGF-V2-KF-40-320	
	10 ... 400	2782923	EAGF-V2-KF-32-400	10 ... 400	2783080	EAGF-V2-KF-40-400	
	1 ... 500	3038083	EAGF-V2-KF-32-	1 ... 500	3038089	EAGF-V2-KF-40-	
	For size 50			For size 63			
	10 ... 100	2783639	EAGF-V2-KF-50-100	10 ... 100	1725842	EAGF-V2-KF-63-100	
	10 ... 200	2784152	EAGF-V2-KF-50-200	10 ... 200	1725843	EAGF-V2-KF-63-200	
	10 ... 320	2784164	EAGF-V2-KF-50-320	10 ... 320	1725844	EAGF-V2-KF-63-320	
	10 ... 400	2784184	EAGF-V2-KF-50-400	10 ... 400	1725845	EAGF-V2-KF-63-400	
	1 ... 500	3038094	EAGF-V2-KF-50-	1 ... 500	2608521	EAGF-V2-KF-63-	
	For size 80			For size 100			
	10 ... 100	1725846	EAGF-V2-KF-80-100	10 ... 100	1725850	EAGF-V2-KF-100-100	
	10 ... 200	1725847	EAGF-V2-KF-80-200	10 ... 200	1725851	EAGF-V2-KF-100-200	
	10 ... 320	1725848	EAGF-V2-KF-80-320	10 ... 320	1725852	EAGF-V2-KF-100-320	
	10 ... 400	1725849	EAGF-V2-KF-80-400	10 ... 400	1725853	EAGF-V2-KF-100-400	
	1 ... 500	2608528	EAGF-V2-KF-80-	1 ... 500	2608532	EAGF-V2-KF-100-	

 - Note

The length of the guide unit must be correspondingly longer for cylinders with piston rod extensions.

 **New**
Sizes: 32, 40, 50

Electric cylinders ESBF, with spindle drive

Accessories

FESTO

Sensor mounting

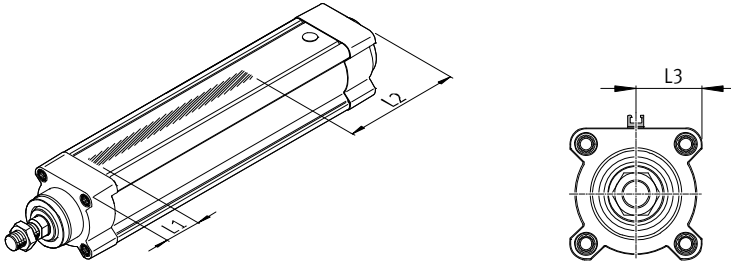

The sensor mountings can only be attached within the highlighted area due to the asymmetry of the internal magnets.

The proximity sensors may not switch reliably if they are mounted outside of this area.



Size	L1	L2	L3
32	26	48	22.3
40	30	65	26.5
50	30	84	31.5
63	33	99	37
80	39	132	46
100	39	151	54.5

Ordering data – Sensor mounting for T-slot

	Description	Length [mm]	Part No.	Type
Sensor rail				
	For proximity sensors SME/SMT-8. If required, multiple sensor rails can be glued on one behind the other.	50	1600093	SAMH-N8-SR-50
		100	1600118	SAMH-N8-SR-100
Mounting kit				
	For proximity sensors SME/SMT-8. The overall length corresponds to the length of the sensing range plus an adjustment range of approx. 10 mm for the proximity sensors.	35	525565	CRSMB-8-32/100

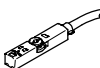
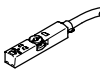

Ordering data – Proximity sensor for T-slot, magneto-resistive

Technical data → Internet: smt

	Type of mounting	Switching output	Electrical connection	Cable length [m]	Part No.	Type
N/O contact						
	Inserted in the slot from above, flush with the cylinder profile, short design	PNP	Cable, 3-wire	2.5	574335	SMT-8M-A-PS-24V-E-2,5-OE
			Plug M8x1, 3-pin	0.3	574334	SMT-8M-A-PS-24V-E-0,3-M8D
			Plug M12x1, 3-pin	0.3	574337	SMT-8M-A-PS-24V-E-0,3-M12
		NPN	Cable, 3-wire	2.5	574338	SMT-8M-A-NS-24V-E-2,5-OE
Plug M8x1, 3-pin	0.3		574339	SMT-8M-A-NS-24V-E-0,3-M8D		
N/C contact						
	Inserted in the slot from above, flush with the cylinder profile, short design	PNP	Cable, 3-wire	7.5	574340	SMT-8M-A-PO-24V-E-7,5-OE

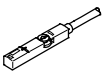

Electric cylinders ESBF, with spindle drive

Accessories

Ordering data – Proximity sensors for T-slot, magnetic reed						Technical data → Internet: sme	
	Type of mounting	Switching output	Electrical connection	Cable length [m]	Part No.	Type	
N/O contact							
	Inserted in the slot from above, flush with the cylinder profile	Contacting	Cable, 3-wire	2.5	543862	SME-8M-DS-24V-K-2,5-OE	
				5.0	543863	SME-8M-DS-24V-K-5,0-OE	
			Cable, 2-wire	2.5	543872	SME-8M-ZS-24V-K-2,5-OE	
				0.3	543861	SME-8M-DS-24V-K-0,3-M8D	
N/C contact							
	Insertable in the slot lengthwise, flush with the cylinder profile	Contacting	Cable, 3-wire	7.5	160251	SME-8-O-K-LED-24	

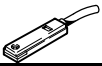
Proximity sensor for size 63 ... 100

Ordering data – Proximity sensor, magneto-resistive CRSMT						Technical data → Internet: crsmt	
	Type of mounting	Switching output	Electrical connection	Cable length [m]	Part No.	Type	
N/O contact							
	Insertable in the slot lengthwise, flush with the cylinder profile	PNP	Cable, 3-wire	2.5	525563	CRSMT-8-PS-K2,5-LED-24	
				5.0	525564	CRSMT-8-PS-K5-LED-24	

Ordering data – Connecting cables					Technical data → Internet: nebu	
	Electrical connection, left	Electrical connection, right	Cable length [m]	Part No.	Type	
	Straight socket, M8x1, 3-pin	Cable, open end, 3-wire	2.5	541333	NEBU-M8G3-K-2.5-LE3	
			5	541334	NEBU-M8G3-K-5-LE3	
	Straight socket, M12x1, 5-pin	Cable, open end, 3-wire	2.5	541363	NEBU-M12G5-K-2.5-LE3	
			5	541364	NEBU-M12G5-K-5-LE3	
	Angled socket, M8x1, 3-pin	Cable, open end, 3-wire	2.5	541338	NEBU-M8W3-K-2.5-LE3	
			5	541341	NEBU-M8W3-K-5-LE3	
	Angled socket, M12x1, 5-pin	Cable, open end, 3-wire	2.5	541367	NEBU-M12W5-K-2.5-LE3	
			5	541370	NEBU-M12W5-K-5-LE3	

Ordering data – Blanking screws, corrosion-resistant							
	For Ø	Material	CRC ¹⁾	Weight [g]	Part No.	Type	PU ²⁾
	32, 40	High-alloy steel	3	6.5	1355016	DAMD-PS-M6-12-R1	4
	50, 63		3	17.5	650121	DAMD-PS-M8-16-R1	
	80, 100		3	23	1355026	DAMD-PS-M10-16-R1	

1) Corrosion resistance class CRC 3 to Festo standard FN 940070

High corrosion stress. Outdoor exposure under moderate corrosive conditions. External visible parts with primarily functional requirements for the surface and which are in direct contact with a normal industrial environment.

2) Packaging unit