

Spindle axes EGC-BS-KF, with recirculating ball bearing guide



Electromechanical drives

Selection aid



Overview of toothed belt and spindle axes

Toothed belt axes

- Speeds of up to 10 m/s
- Acceleration of up to 50 m/s²
- Repetition accuracy of up to ±0.08 mm
- Strokes of up to 8500 mm (longer strokes on request)
- Flexible motor mounting

Spindle axes

- Speeds of up to 2 m/s
- Acceleration of up to 20 m/s²
- Repetition accuracy of up to ±0.003 mm
- Strokes of up to 3000 mm

Coordinate system

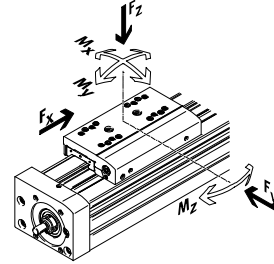

Toothed belt axes

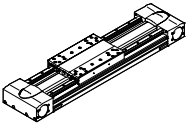
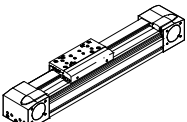
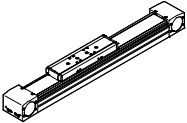
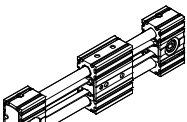
Type	F_x [N]	v [m/s]	M_x [Nm]	M_y [Nm]	M_z [Nm]	Properties
Heavy-duty recirculating ball bearing guide						
EGC-HD-TB						
	450	3	140	275	275	<ul style="list-style-type: none"> • Flat drive unit with rigid, closed profile • Precision, resilient DUO guide rail • Ideal as a basic axis for linear gantries and cantilever axes
	1000	5	300	500	500	
	1800	5	900	1450	1450	
Recirculating ball bearing guide						
EGC-TB-KF						
	50	3	3.5	10	10	<ul style="list-style-type: none"> • Rigid, closed profile • Precision, resilient guide rail • Small drive pinions reduce necessary driving torque • Space-saving position sensing
	100	5	16	132	132	
	350	5	36	228	228	
	800	5	144	680	680	
	2500	5	529	1820	1820	
ELGA-TB-KF						
	350	5	16	132	132	<ul style="list-style-type: none"> • Internal guide and toothed belt • Precision, resilient guide rail • Guide and toothed belt protected by cover strip • High feed forces
	800	5	36	228	228	
	1300	5	104	680	680	
	2000	5	167	1150	1150	
ELGR-TB						
	50	3	2.5	20	20	<ul style="list-style-type: none"> • Cost-optimised rod guide • Ready-to-install unit • Resilient ball bearings for dynamic operation
	100	3	5	40	40	
	350	3	15	124	124	

Electromechanical drives

Selection aid

Overview of toothed belt and spindle axes

Toothed belt axes

- Speeds of up to 10 m/s
- Acceleration of up to 50 m/s²
- Repetition accuracy of up to ±0.08 mm
- Strokes of up to 8500 mm (longer strokes on request)
- Flexible motor mounting

Spindle axes

- Speeds of up to 2 m/s
- Acceleration of up to 20 m/s²
- Repetition accuracy of up to ±0.003 mm
- Strokes of up to 3000 mm

Coordinate system

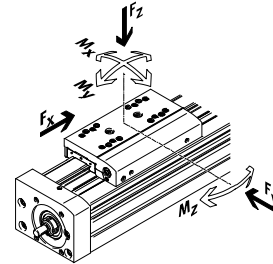

Toothed belt axes

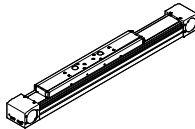
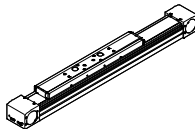
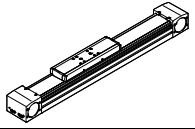
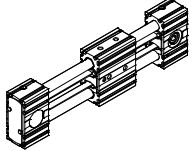
Type	F _x [N]	v [m/s]	M _x [Nm]	M _y [Nm]	M _z [Nm]	Properties
Roller bearing guide						
ELGA-TB-RF						
	350 800 1300	10 10 10	11 30 100	40 180 640	40 180 640	<ul style="list-style-type: none"> • Heavy-duty roller bearing guide • Guide and toothed belt protected by cover strip • Speeds of up to 10 m/s • Lower weight than axes with guide rails
ELGA-TB-RF-F1						
	260 600 1000	10 10 10	8.8 24 80	32 144 512	32 144 512	<ul style="list-style-type: none"> • Suitable for use in the food zone • Sturdy roller bearing guide • Guide and toothed belt protected by cover strip • Speeds of up to 10 m/s • Lower weight than axes with guide rails
Plain-bearing guide						
ELGA-TB-G						
	350 800 1300	5 5 5	5 10 120	30 60 120	10 20 40	<ul style="list-style-type: none"> • Guide and toothed belt protected by cover strip • For simple handling tasks • As an actuator for external guides • Insensitive to harsh environmental conditions
ELGR-TB-GF						
	50 100 350	1 1 1	1 2.5 1	10 20 40	10 20 40	<ul style="list-style-type: none"> • Cost-optimised rod guide • Ready-to-install unit • Heavy-duty plain bearings for use in harsh environmental conditions

Electromechanical drives

Selection aid



Overview of toothed belt and spindle axes

Toothed belt axes

- Speeds of up to 10 m/s
- Acceleration of up to 50 m/s²
- Repetition accuracy of up to ±0.08 mm
- Strokes of up to 8500 mm (longer strokes on request)
- Flexible motor mounting

Spindle axes

- Speeds of up to 2 m/s
- Acceleration of up to 20 m/s²
- Repetition accuracy of up to ±0.003 mm
- Strokes of up to 3000 mm

Coordinate system

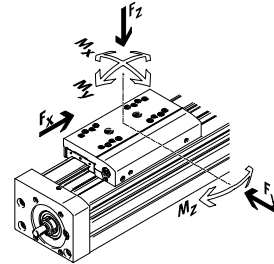

Spindle axes

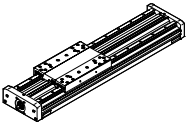
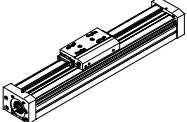
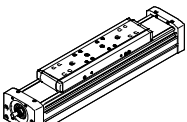
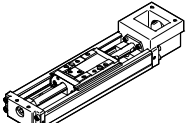
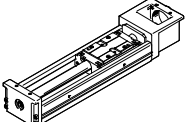
Type	F_x [N]	v [m/s]	M_x [Nm]	M_y [Nm]	M_z [Nm]	Properties
Heavy-duty recirculating ball bearing guide						
EGC-HD-BS						
	300 600 1300	0.5 1.0 1.5	140 300 900	275 500 1450	275 500 1450	<ul style="list-style-type: none"> • Flat drive unit with rigid, closed profile • Precision, resilient DUO guide rail • Ideal as a basic axis for linear gantries and cantilever axes
Recirculating ball bearing guide						
EGC-BS-KF						
	300 600 1300 3000	0.5 1.0 1.5 2.0	16 36 144 529	132 228 680 1820	132 228 680 1820	<ul style="list-style-type: none"> • Rigid, closed profile • Precision, resilient guide rail • For extremely high requirements for speed force and precision • Space-saving position sensing
ELGA-BS-KF						
	300 600 1300 3000	0.5 1.0 1.5 2.0	16 36 104 167	132 228 680 1150	132 228 680 1150	<ul style="list-style-type: none"> • Internal guide and ball screw • Precision guide rail with high load capacity • For the highest requirements for feed force and precision • Guide and ball screw protected by cover strip • Space-saving position sensing
EGSK						
	57 133 184 239 392	0.33 1.10 0.83 1.10 1.48	13 28.7 60 79.5 231	3.7 9.2 20.4 26 77.3	3.7 9.2 20.4 26 77.3	<ul style="list-style-type: none"> • Spindle axes with maximum precision, compactness and rigidity • Recirculating ball bearing guide and ball screw without caged ball bearings • Standard designs in stock
EGSP						
	112 212 466 460	0.6 0.6 2.0 2.0	36.3 81.5 90.3 258	12.5 31.6 32.1 94	12.5 31.6 32.1 94	<ul style="list-style-type: none"> • Spindle axes with maximum precision, compactness and rigidity • Recirculating ball bearing guide with caged ball bearings • Ball screw sizes 33, 46 with caged ball bearings

Spindle axes EGC-BS-KF, with recirculating ball bearing guide

Key features

At a glance

Powerful

- Generously sized profiles with an optimised cross section afford maximum rigidity and load capacity
- Speed, acceleration and torque resistance set a new standard

Economical

- In addition to its technical data, the spindle axis also offers an excellent price/performance ratio
- Due to the EGC's high performance it is often possible to use a smaller size

Versatile

- Different spindle pitches, numerous sizes and variants such as protected guides open up a broad range of applications
- Space-saving position sensing with proximity sensors in the profile slot is possible
- Wide range of options for mounting on drives
- Comprehensive range of mounting accessories for multi-axis combinations
- Spindle support enables maximum travel speed with all stroke lengths

Comprehensive range for the most varied load conditions

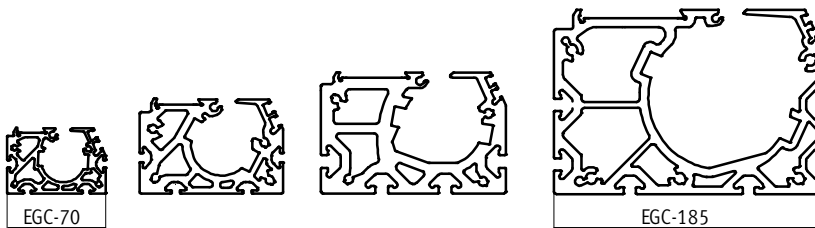

Characteristic values of the axes

The specifications shown in the table are maximum values.

The precise values for each of the variants can be found in the relevant technical data in the catalogue.

Version	Size	Working stroke [mm]	Speed [m/s]	Repetition accuracy [mm]	Feed force [N]	Guide characteristics				
						Forces and torques				
						Fy [N]	Fz [N]	Mx [Nm]	My [Nm]	Mz [Nm]
Recirculating ball bearing guide										
	70	50 ... 1000	0.5	±0.02	300	1850	1850	16	132	132
	80	50 ... 2000	1.0	±0.02	600	3050	3050	36	228	228
	120	50 ... 2500	1.5	±0.02	1300	6890	6890	144	680	680
	185	50 ... 3000	2.0	±0.02	3000	15200	15200	529	1820	1820

- - Note

PositioningDrives
sizing software
www.festo.com

Spindle axes EGC-BS-KF, with recirculating ball bearing guide

Key features

FESTO

Slide variants

Standard slide



Extended slide



Additional slide



Guide options

Protected version



- The protected guide cleans the guide rail and protects the recirculating ball bearing guide with the aid of an additional wiper

With central lubrication

→ 23



- The lubrication adapter enables the guide to be permanently lubricated using semi or fully automatic relubrication devices
- The adapters are suitable for oils and greases
- Both lubrication adapters must be connected

Displacement encoder

→ 14

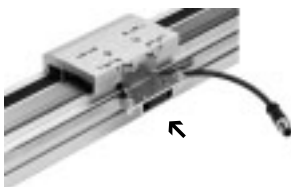

- The position of the slide can be sensed directly when using the incremental displacement encoder. This means that all elasticities of the drive train can be detected and can be corrected by the motor controller

Clamping unit

→ 15

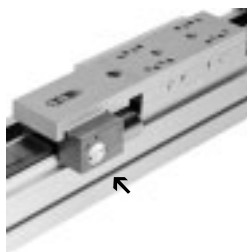

- 1 or 2-channel design, for holding loads
- Reliable holding is guaranteed since the forces act directly on the slide
- A limited number of emergency braking operations are permissible with the sizes 120 and 185

Spindle axes EGC-BS-KF, with recirculating ball bearing guide

Key features

Complete system comprising spindle axis, motor, motor controller and motor mounting kit
Spindle axis with recirculating ball bearing guide



Motor

→48



1



2

- 1 Servo motor EMME-AS, EMMS-AS
- 2 Stepper motor EMMS-ST

-  - Note

A range of specially adapted complete solutions is available for the spindle axis EGC and the motors.

Motor controller

Technical data → Internet: motorcontroller



1



2

- 1 Servo motor controller CMMP-AS
- 2 Stepper motor controller CMMS-ST

Motor mounting kit

Axial kit

→48

Parallel kit

→53



Spindle axes EGC-BS-KF, with recirculating ball bearing guide

Peripherals overview

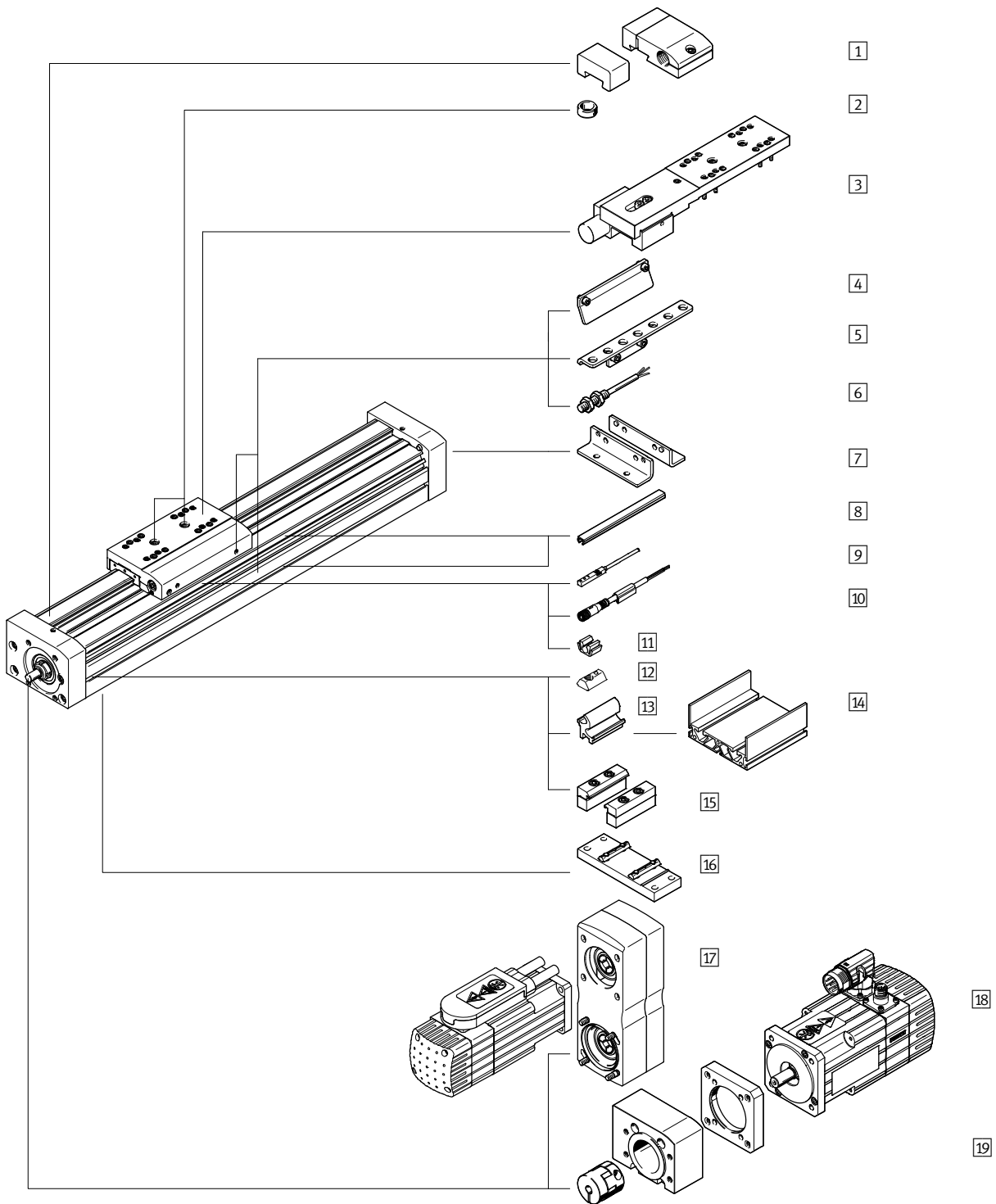

Spindle axes EGC-BS-KF, with recirculating ball bearing guide

Peripherals overview

Variants and accessories		
Type	Description	→ Page/Internet
1 Emergency buffer with retainer A	For avoiding damage at the end stop in the event of malfunction	57
2 Centring pin/sleeve ZBS, ZBH	For centring loads and attachments on the slide 2 centring pins/sleeves included in the scope of delivery of the axis	59
3 Clamping unit 1H...-PN, 2H-PN	For holding loads	15
4 Switch lug X, Z, O, P, W, R	For sensing the slide position	57
5 Sensor bracket O, P, W, R	Adapter for mounting the inductive proximity sensors (round design) on the axis	58
6 Proximity sensor, M8 O, P, W, R	Inductive proximity sensor, round design The order code O, P, W, R includes 1 switch lug and max. 2 sensor brackets in the scope of delivery	61
7 Foot mounting F	For mounting the axis on the end cap (only possible on one side)	55
8 Slot cover B, S	For protecting against ingress of dirt	59
9 Proximity sensor, T-slot X, Z	Inductive proximity sensor, for T-slot The order code X, Z includes 1 switch lug in the scope of delivery	60
10 Connecting cable V	For proximity sensor (order code W and R)	61
11 Clip CL	For mounting the proximity sensor cable in the slot	59
12 Slot nut Y	For mounting attachments	59
13 Adapter kit DHAM	For mounting the support profile on the axis	60
14 Support profile HMIA	For mounting and guiding an energy chain	60
15 Profile mounting M	For mounting the axis on the side of the profile	55
16 Central support EAHF EAHF-L5	For mounting the axis from underneath on the profile	56
17 Parallel kit EAMM-U	For parallel motor mounting (consisting of: housing, clamping sleeve, toothed belt pulley, toothed belt)	53
18 Motor EMME, EMMS	Motors specially matched to the axis, with or without brake	48
19 Axial kit EAMM-A	For axial motor mounting (consisting of: coupling, coupling housing and motor flange)	48
– Passive guide axis EGC-FA	Axis without drive	egc-fa

Spindle axes EGC-BS-KF, with recirculating ball bearing guide

Type codes

	EGC	-	70	-	500	-	BS	-		-		-	KF	-		-	MR	-	GK	
Type																				
EGC	Spindle axis																			
Size																				
Stroke [mm]																				
Drive function																				
BS	Ball screw spindle																			
Spindle pitch																				
Spindle support																				
-	None																			
S	With spindle support																			
Guide																				
KF	Recirculating ball bearing guide																			
Stroke reserve																				
Motor attachment position																				
ML	On the left																			
MR	On the right																			
Slide																				
GK	Standard slide																			
GV	Extended slide																			
GP	Standard slide, protected																			
GQ	Extended slide, protected																			

Spindle axes EGC-BS-KF, with recirculating ball bearing guide

Type codes

→		-	-	-	-	-	ZUB -	F2MX2Z	-	DN
Additional slide										
KL	Standard, left									
Additional slide										
KR	Standard, right									
Lubrication function										
-	Standard									
C	Lubrication adapter									
Displacement encoder, incremental										
M1	Resolution: 2.5 µm									
M2	Resolution: 10 µm									
Clamping unit										
1HL	1-channel, left									
1HR	1-channel, right									
2H	2-channel									
Actuation type										
PN	Pneumatically actuated									
Accessories enclosed separately										
F	Foot mounting									
...M	Profile mounting									
...B	Mounting slot cover									
...S	Sensor slot cover									
...Y	Slot nut for mounting slot									
...X	Proximity sensor (SIES), inductive, slot type 8, PNP, N/O contact, 7.5 m cable									
...Z	Proximity sensor (SIES), inductive, slot type 8, PNP, N/C contact, 7.5 m cable									
...A	Emergency buffer with retainer									
...O	Proximity sensor (SIEN), inductive, M8, PNP, N/O contact, 2.5 m cable									
...P	Proximity sensor (SIEN), inductive, M8, PNP, N/C contact, 2.5 m cable									
...W	Proximity sensor (SIEN), inductive, M8, PNP, N/O contact, plug M8									
...R	Proximity sensor (SIEN), inductive, M8, PNP, N/C contact, plug M8									
...V	Connecting cable									
...CL	Cable clip									
Operating instructions										
DN	None									

Spindle axes EGC-BS-KF, with recirculating ball bearing guide

FESTO

Technical data

Function

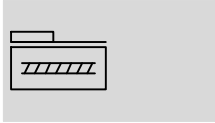

- - Size
70 ... 185
- - Stroke length
50 ... 3000 mm
- - www.festo.com

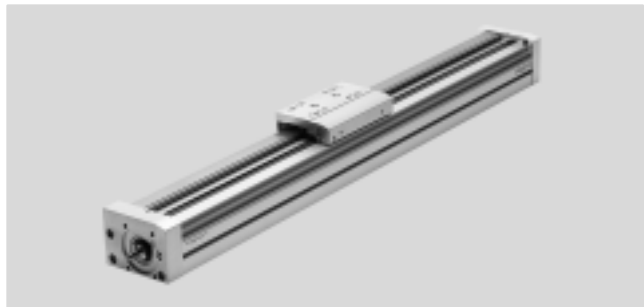

General technical data							
Size		70	80		120		185
Spindle pitch		10	10	20	10	25	40
Design	Electromechanical axis with recirculating ball bearing spindle						
Guide	Recirculating ball bearing guide						
Mounting position	Any						
Working stroke							
EGC-...-GK/-GP	[mm]	50 ... 1000	50 ... 2000		50 ... 2500		50 ... 3000
EGC-...-GV/-GQ	[mm]	50 ... 900	50 ... 1900		50 ... 2400		50 ... 2900
Max. feed force F_x	[N]	300	600		1,300		3,000
No-load torque	[Nm]	0.3	0.5	0.5	1.5	1.5	3.0
at min. travel speed	[m/s]	0.05	0.1	0.1	0.2	0.2	0.2
No-load torque	[Nm]	0.45	0.75	0.75	2.25	2.25	6.5
at max. travel speed	[m/s]	0.5	0.5	1	0.6	1.5	2
Max. radial force ¹⁾	[N]	220	250		500		4000
Max. rotational speed ²⁾	[rpm]	3000	3000		3600		3000
Max. acceleration	[m/s ²]	15					
Repetition accuracy	[mm]	±0.02					

1) At the drive shaft

2) Rotational speed and speed are stroke-dependent

Operating and environmental conditions		
Ambient temperature	[°C]	-10 ... +60
Protection class		IP40
Duty cycle	[%]	100

Spindle axes EGC-BS-KF, with recirculating ball bearing guide

Technical data

Weight [g]				
Size	70	80	120	185
Basic weight with 0 mm stroke ¹⁾				
EGC-...-GK/-GP	1500	2700	12500	30000
EGC-...-GV/-GQ	2000	3500	14400	34500
Additional weight per 10 mm stroke	50	80	190	390
Moving load				
EGC-...-GK/-GP	400	740	2400	8600
EGC-...-GV/-GQ	600	950	2900	9850
Additional slide				
EGC-...-KL/-KR	300	550	2000	6000
Clamping unit				
EGC-...-1H...-PN	-	700	2300	4900
EGC-...-2H-PN	-	1300	4000	8300

1) Incl. slide

Spindle				
Size	70	80	120	185
Diameter [mm]	12	15	25	40
Pitch [mm/rev.]	10	10 20	10 25	40

Mass moment of inertia							
Size	70	80	120	185			
Spindle pitch	10	10 20	10 25	40			
J ₀							
EGC-...-GK [kg mm ²]	1.99	5.2 5.2	64.46 64.46	594			
EGC-...-GV [kg mm ²]	3.41	8.67 8.68	92 92	774.71			
J _H per metre stroke [kg mm ² /m]	14.2	34.6 34.6	275.6 275.6	1803.1			
J _L per kg effective load [kg mm ² /kg]	2.53	2.53 10.13	2.53 15.83	40.53			
J _W Slide							
EGC-...-GK [kg mm ²]	1.04	1.86 7.46	6.09 38.06	348.87			
EGC-...-GV [kg mm ²]	1.48	2.34 9.35	7.34 45.85	399.08			
J _F Clamping unit							
EGC-...-1H...-PN [kg mm ²]	-	1.78 7.1	5.8 36.4	198.5			
EGC-...-2H-PN [kg mm ²]	-	3.3 13.2	10 63.3	336.4			

The mass moment of inertia J_A of the entire axis is calculated as follows:

$$J_A = J_0 + \sum J_W + J_H \times \text{working stroke [m]} + J_L \times m_{\text{effective load [kg]}} + J_F$$

$\sum J_W$ = Total mass moment of inertia of all slides (including the first slide)

Spindle axes EGC-BS-KF, with recirculating ball bearing guide

Technical data

Materials

Sectional view

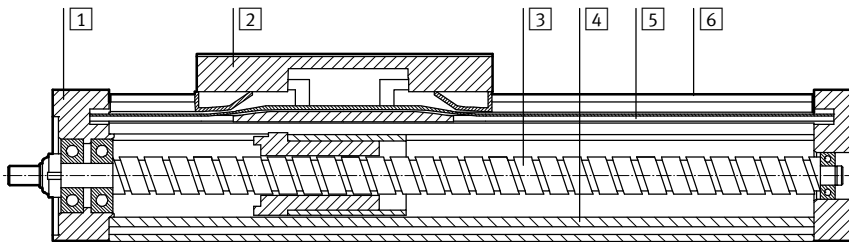

Axis	
1	End cap Anodised wrought aluminium alloy
2	Slide Anodised wrought aluminium alloy
3	Spindle Steel
4	Profile Anodised aluminium
5	Cover band Polyurethane
6	Guide rail High-alloy steel
Note on materials RoHS-compliant	

Technical data – Displacement encoder		Dimensions → 39	
Type		EGC-...-M1	EGC-...-M2
Resolution	[µm]	2.5	10
Max. travel speed with motor controller CMMP-AS-...	[m/s]	4	4
Encoder signal		5 V TTL; A/A, B/B without zero pulse	
Signal output		Line Driver, push-pull, proof against continuous short circuits	
Electrical connection		8-pin plug, round design, M12	
Cable length	[mm]	160	

Operating and environmental conditions – Displacement encoder	
Ambient temperature	[°C] -10 ... +70
Protection class	IP64
CE marking (see declaration of conformity)	To EU EMC Directive ¹⁾

1) For information about the applicability of the component see the manufacturer's EC declaration of conformity at: www.festo.com/sp → User documentation.
If the component is subject to restrictions on usage in residential, office or commercial environments or small businesses, further measures to reduce the emitted interference may be necessary.

Instructions for use

The spindle axis with displacement encoder is not designed for the following sample applications:

- Magnetic field

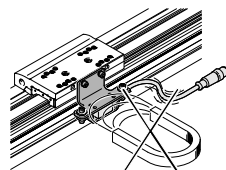

- Welding application

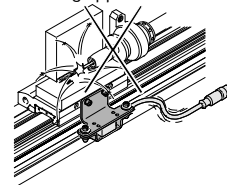

Spindle axes EGC-BS-KF, with recirculating ball bearing guide

Technical data

Technical data – Clamping unit				Dimensions → 40
Size		80	120	185
Pneumatic connection		M5	M5	M5
Clamping type		Clamping via spring force, released via compressed air		
Static holding force				
EGC-...-1H...-PN	[N]	320	1200	1500
EGC-...-2H-PN	[N]	640	2400	3000
Max. number of emergency braking operations ¹⁾ at reference energy	[[]]	–	750 35	750 70
Number of clamping operations under nominal load	[million switching cycles]	0.45	0.05	> 1.4

1) Emergency braking refers to braking the effective load if the drive axis loses power.

Operating and environmental conditions – Clamping unit			
Operating medium		Compressed air according to ISO 8573-1:2010 [7:4:4]	
Operating pressure			
Clamping unit opened	[bar]	4.5 ... 8	
Clamping unit closed	[bar]	Pressureless	
Ambient temperature	[°C]	–10 ... +60	

 Note
The axis can only be relubricated with the lubrication adapter when used in combination with the clamping unit (EGC-...-C).

Spindle axes EGC-BS-KF, with recirculating ball bearing guide

Technical data

FESTO

Characteristic load values

The indicated forces and torques refer to the slide surface. The point of application of force is the point where the centre of the guide and the longitudinal centre of the slide intersect.

These values must not be exceeded during dynamic operation. Special attention must be paid to the cushioning phase.

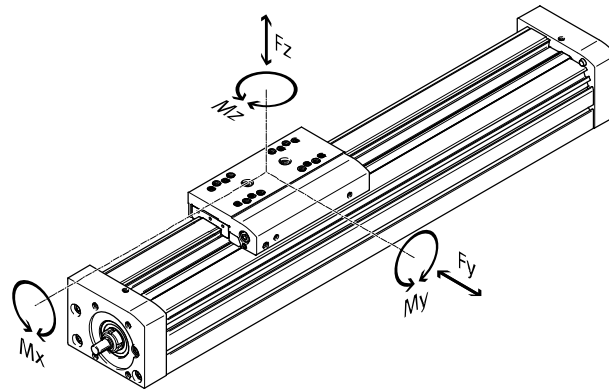

Max. permissible forces and torques for a service life of 5000 km						
Size		70	80	120	185	
F _{y,max.}	[N]	1850	3050	6890	15200	
F _{z,max.}	[N]	1850	3050	6890	15200	
M _{x,max.}	[Nm]	16	36	144	529	
M _{y,max./M_{z,max.}}						
EGC-...-GK/-GP	[Nm]	51	97	380	1157	
M _{y,max./M_{z,max.}}						
EGC-...-GV/-GQ	[Nm]	132	228	680	1820	

Basic load ratings							
Size		70	80	120	185		
Spindle pitch		10	10	20	10	25	40
Ball screw							
Dynamic c _{dyn,BS}	[N]	4000	6820	7480	16000	13700	36200

-  Note

For a service life of 5000 km for the guide system, the load comparison factor must have a value of $f_v < 1$,

based on the maximum permissible forces and torques for a service life of 5000 km.

If the axis is simultaneously subjected to several of the indicated forces and torques, the following equation

must be satisfied in addition to the indicated maximum loads:

Calculating the load comparison factor:

$$f_v = \frac{|F_{y,dyn}|}{F_{y,max}} + \frac{|F_{z,dyn}|}{F_{z,max}} + \frac{|M_{x,dyn}|}{M_{x,max}} + \frac{|M_{y,dyn}|}{M_{y,max}} + \frac{|M_{z,dyn}|}{M_{z,max}}$$

Spindle axes EGC-BS-KF, with recirculating ball bearing guide

Technical data

Calculating service life

The service life of the guide depends on the load. To provide a rough indication of the service life of the

guide, the graph below plots the load comparison factor f_v against the service life.

These values are only theoretical. You must consult your local contact person at Festo for load comparison factors f_v greater than 1.5.

Load comparison factor f_v as a function of service life

Example:

A user wants to move an X kg load. Using the formula $\rightarrow 16$ gives a value of 1.5 for the load comparison factor f_v . According to the graph, the guide would have a service life of

approx. 1500 km. Reducing the acceleration reduces the M_z and M_y values. A load comparison factor f_v of 1 now gives a service life of 5000 km.

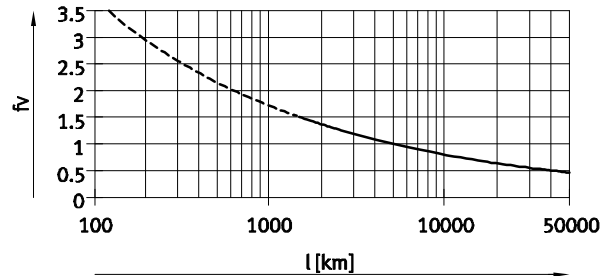

Note

PositioningDrives
sizing software
www.festo.com

The guide workload for a service life of 5000 km can be calculated with the help of the sizing software.

$f_v > 1.5$ are only theoretical comparison values for the recirculating ball bearing guide.

Comparison of the characteristic load values for 5000 km with dynamic forces and torques of recirculating ball bearing guides

The characteristic load values of roller bearing guides are standardised to ISO and JIS using dynamic and static forces and torques. These forces and torques are based on an expected service life for the guide system of 100 km to ISO or 50 km to JIS.

As the characteristic load values are dependent on the service life, the max. permissible forces and torques for a service life of 5000 km cannot be compared with the dynamic forces and torques of roller bearing guides to ISO/JIS.

To make it easier to compare the guide capacity of linear axes EGC with roller bearing guides, the table below lists the theoretically permissible forces and torques for a calculated service life of 100 km. This corresponds to the dynamic forces and torques to ISO.

These 100 km values have been calculated mathematically and are only to be used for comparing with dynamic forces and torques to ISO. The drives must not be loaded with these characteristic values as this could damage them.

Max. permissible forces and torques for a theoretical service life of 100 km (from a guide perspective only)

Size		70	80	120	185
$F_{y_{max}}$	[N]	6815	11236	25383	55997
$F_{z_{max}}$	[N]	6815	11236	25383	55997
$M_{x_{max}}$	[Nm]	59	133	531	1949
$M_{y_{max}}/M_{z_{max}}$					
EGC-...-GK/-GP	[Nm]	188	357	1400	4262
$M_{y_{max}}/M_{z_{max}}$					
EGC-...-GV/-GQ	[Nm]	486	840	2505	6705

Spindle axes EGC-BS-KF, with recirculating ball bearing guide

Technical data

FESTO

Speed v as a function of working stroke l

EGC-70

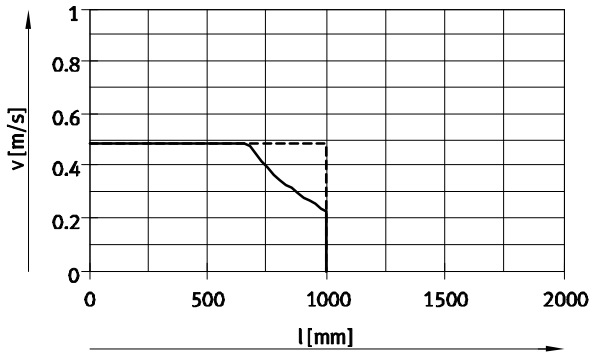

— EGC-70-10P without spindle support
 - - - EGC-70-10P with spindle support

EGC-80

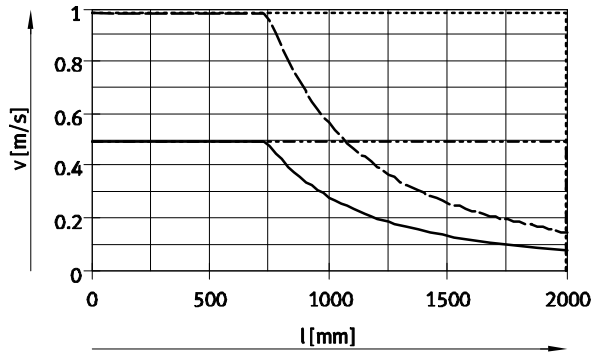

— EGC-80-10P without spindle support
 - - - EGC-80-10P with spindle support
 — EGC-80-20P without spindle support
 - - - EGC-80-20P with spindle support

EGC-120

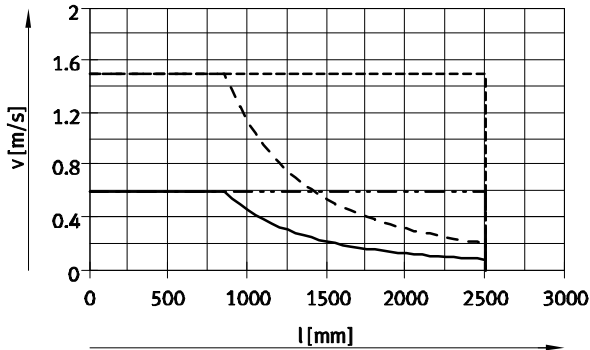

— EGC-120-10P without spindle support
 - - - EGC-120-10P with spindle support
 — EGC-120-25P without spindle support
 - - - EGC-120-25P with spindle support

EGC-185

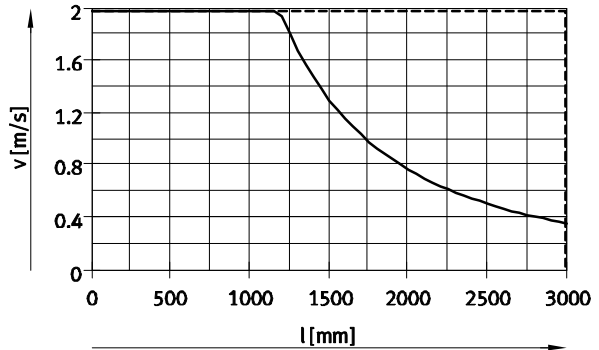

— EGC-185-40P without spindle support
 - - - EGC-185-40P with spindle support

Speed v as a function of rotational speed n

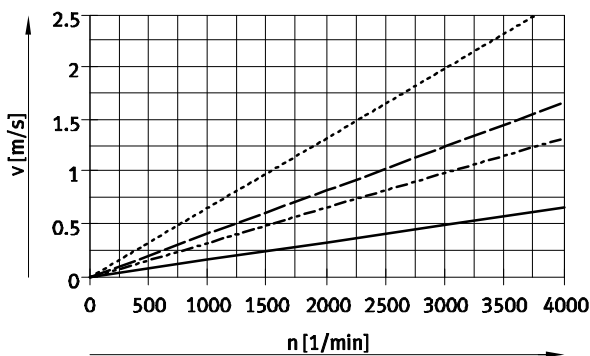

 Note
 Rotational speed is stroke-dependent.
 Note maximum rotational speed.

— EGC-70/-80-10P/-120-10P
 - - - EGC-80-20P
 - · - EGC-120-25P
 ····· EGC-185

Spindle axes EGC-BS-KF, with recirculating ball bearing guide

Technical data

Maximum acceleration a as a function of applied load m

EGC-70

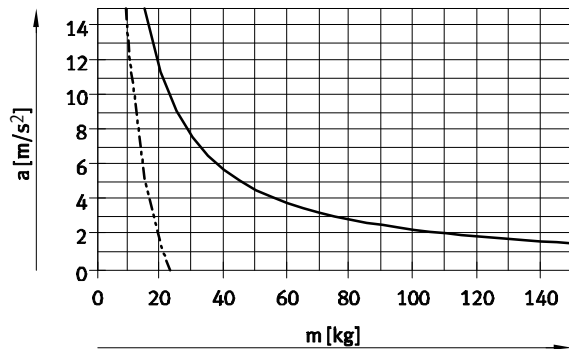

EGC-80

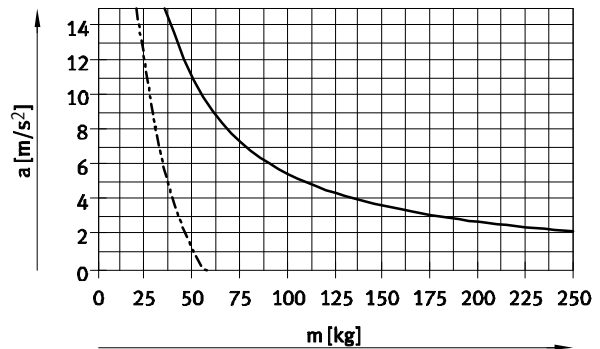

EGC-120

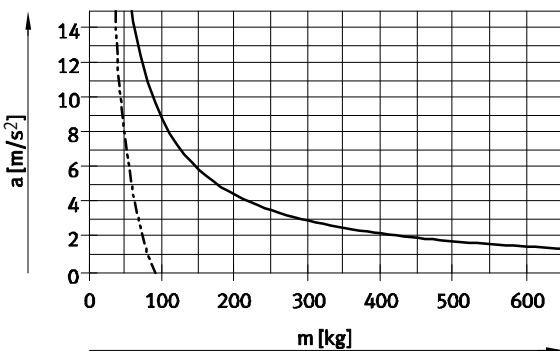

EGC-185

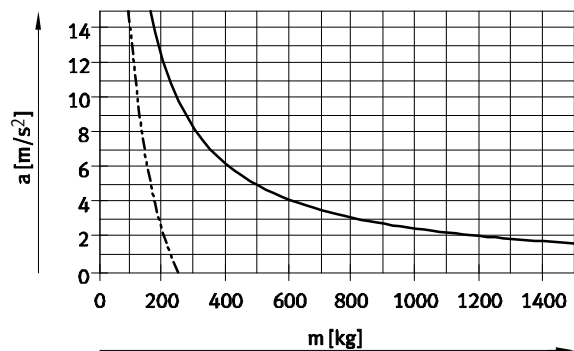

— Horizontal mounting position - - - - - Vertical mounting position

Theoretical feed force F as a function of input torque M

EGC-70/-80

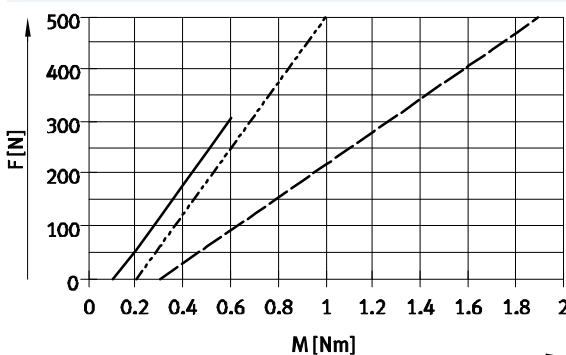

EGC-120/-185

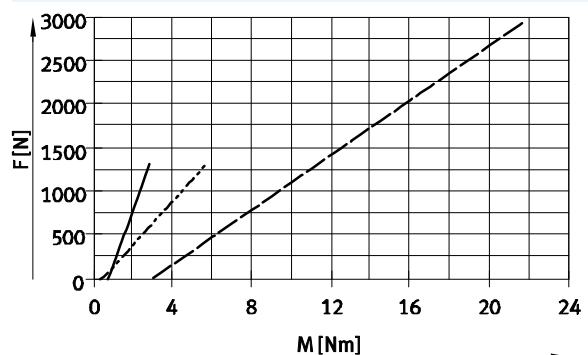

— EGC-70-10P - - - - - EGC-80-20P
 ····· EGC-80-10P

— EGC-120-BS-10P - - - - - EGC-185-BS-40P
 ····· EGC-120-BS-25P

Spindle axes EGC-BS-KF, with recirculating ball bearing guide

Technical data



Stroke reserve			
Stroke length	Stroke reserve		
The selected stroke corresponds in principle to the required working stroke. The variants GK/GV do not have a wiper seal on the guide. These variants therefore additionally have a safety distance between the drive cap and slide that is not designated as part of the working stroke.	A safety distance (similar to GK/GV) between the drive cap and slide can be defined for the variants GP/GQ and GK-C/GV-C using the modular product system via the "stroke reserve" feature. With the variants GK/GV, the stroke reserve and safety distance are added for each end position.	<ul style="list-style-type: none"> The stroke reserve length can be freely selected The sum of the stroke length and 2x stroke reserve must not exceed the maximum working stroke 	Example: EGC-70-500-BS-10P-KF-20H-... Working stroke = 500 mm 2x stroke reserve = 40 mm Total stroke = 540 mm (540 mm = 500 mm + 2x 20 mm)

Size	70	80		120		185
Spindle pitch	10	10	20	10	25	40
L9 = safety distance with GK/GV (per end position) [mm]	10.5	13	13	18	18	21

Working stroke reduction

With standard slide GK/GP / extended slide GV/GQ with additional slide KL/KR

- The working stroke is reduced by the length of the additional slide and the distance between both slides
- If the variant GP/GQ is ordered, the additional slide is also protected
- If the variant GV/GQ is ordered, the additional slide is not extended
- If the variant GK-C/GV-C is ordered, the additional slide is also supplied with lubrication adapters

L16 = Slide length
 L17 = Additional slide length

L18 = Distance between both slides
 1 Additional slide

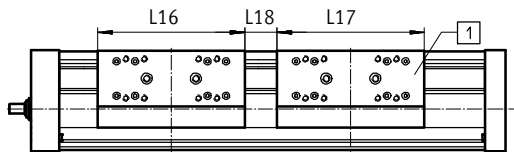

Example:
 Type EGC-70-500-BS-...-GK-KR
 Working stroke without additional slide = 500 mm
 L18 = 20 mm
 L16, L17 = 100 mm
 Working stroke with additional slide = 380 mm
 (500 mm - 20 mm - 100 mm)

Dimensions – Additional slide								
Size	70		80		120		185	
	GK/GV	GP/GQ	GK/GV	GP/GQ or GK-C/GV-C	GK/GV	GP/GQ or GK-C/GV-C	GK/GV	GK-C/GV-C
Length L17 [mm]	100	121	120	146	203.3	236	282.8	322
Min. distance between the slides L18 [mm]	-	21	-	26	-	36	-	42

Spindle axes EGC-BS-KF, with recirculating ball bearing guide

Technical data

Working stroke reduction per side

With integrated emergency buffer NPE and shock absorber retainer KYE

- The working stroke is reduced by the total dimension of the emergency buffer and shock absorber retainer.
- The rubber buffer in the cap must be removed.
- Shock absorbers must not be used in combination with lubrication adapters.

Size	70	80	120	185
With emergency buffer [mm]	43	68	98	133

Working stroke reduction

With integrated clamping unit

- The working stroke is reduced by the length of the clamping unit.
- With 1-channel clamping units, the stroke is reduced on one side with respect to the mounting surface.
- With 2-channel clamping units, the stroke is reduced symmetrically with respect to the mounting surface of the load.
- Shock absorbers must not be used in combination with the clamping unit.

Size	80	120	185
EGC-...-1H...-PN [mm]	87	124	131
EGC-...-2H-PN [mm]	174	248	262

2nd moment of area

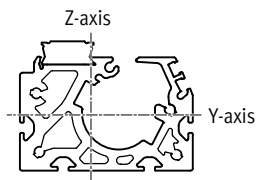

Size	70	80	120	185
ly [mm ⁴]	4.19x10 ⁵	9.81x10 ⁵	5.01x10 ⁶	2.61x10 ⁷
lz [mm ⁴]	5.78x10 ⁵	1.32x10 ⁶	5.82x10 ⁶	2.6x10 ⁷

Spindle axes EGC-BS-KF, with recirculating ball bearing guide

Technical data



Maximum permissible support span L (without profile mounting MUE/central support EAHF) as a function of force F

In order to limit deflection in the case of large strokes, the axis may need to be supported.

The following graphs can be used to determine the maximum permissible support span L as a function of force F acting on the axis. The deflection is $f = 0.5 \text{ mm}$.

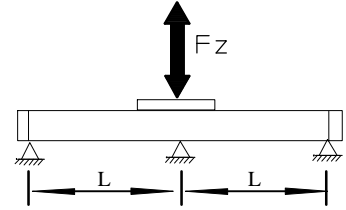
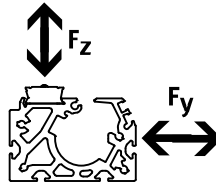

Force Fy

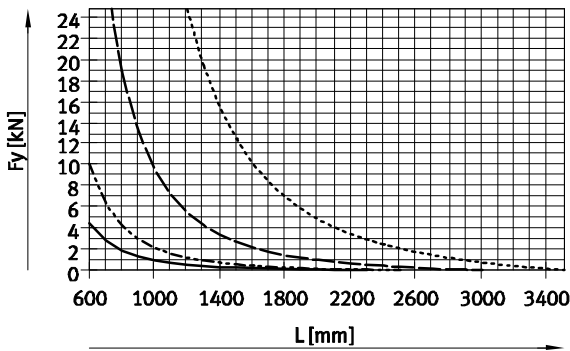

Force Fz

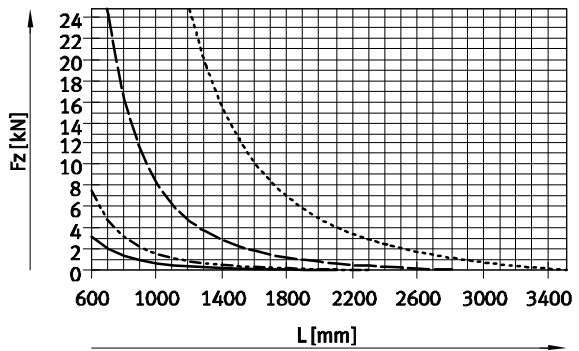

- EGC-70 - - - - - EGC-120
- EGC-80 - - - - - EGC-185

Recommended deflection limits

Adherence to the following deflection limits is recommended so as not to

impair the functional performance of the axes. Greater deformation can

result in increased friction, greater wear and reduced service life.

Size	Dyn. deflection (load moving)	Stat. deflection (load stationary)
70 ... 185	0.05% of the axis length, max. 0.5 mm	0.1% of the axis length

Spindle axes EGC-BS-KF, with recirculating ball bearing guide

Technical data

Central lubrication

The lubrication adapter enables the guide of the spindle axis EGC-BS to be permanently lubricated in applications in humid or wet ambient conditions using semi or fully automatic relubrication devices.

- For size 80, 120, 185
- The modules are suitable for oils and greases
- The dimensions of the spindle axis EGC-BS are the same with and without central lubrication modules
- Both lubrication adapters must be connected
- There are three connection options on each side
- Can be used in combination with:
 - Standard slide GK
 - Additional slide KL, KR
- Cannot be used in combination with:
 - Protected recirculating ball bearing guide GP

Slide dimensions
→ 34

Order code C in the modular product system → 46

Connection option for customer design

The drawing opposite shows the connection option on the top lubrication interface using a customer design.

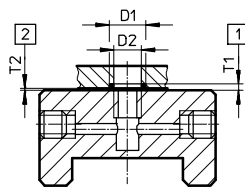

- D1 8^{+0.2} mm
- D2 6 mm
- T1 0.6_{-0.05} mm
- T2 0.1^{+0.2} mm
- O-ring ∅ 6x1 mm (DIN3771)

- 1 Slot depth for O-ring
- 2 Required air gap

Additional dimensions → 34

Structure of a central lubrication system

A central lubrication system requires various additional components. The illustration shows different options (using a hand pump, pneumatic container pump or electric container pump) required as a minimum for designing a central lubrication system. Festo does not sell these additional components, however they can be obtained from the following companies:

- Lincoln
- Bielomatik
- SKF (Vogel)

Festo recommends these companies because they can supply all the necessary components.

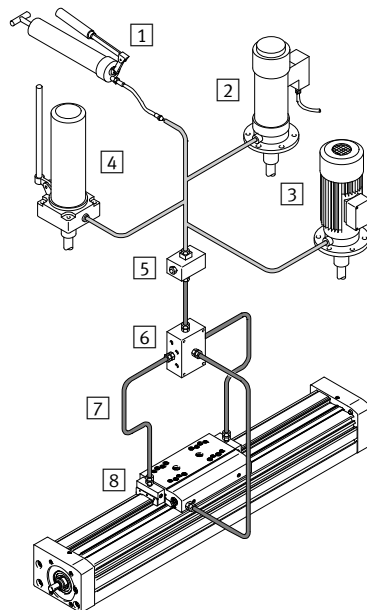

- 1 Hand pump
- 2 Pneumatic container pump
- 3 Electric container pump
- 4 Manually operated container pump
- 5 Nipple block
- 6 Distributor block
- 7 Tubing or piping
- 8 Fittings

Spindle axes EGC-BS-KF, with recirculating ball bearing guide



Technical data

Dimensions Download CAD data → www.festo.com

+ = plus stroke length + 2x stroke reserve
 L9 With GK/GV: safety distance per end position
 With GP/GQ: dimension for wiper seal → 20
 With GK-C/GV-C: dimension for adapter → 34

Working stroke reduction in combination with additional slide → 20

Size	Variant	Stroke	B1	B2	B3	B4	B5	B6	B7	B9	D1 ∅ H7	D2 ∅ h7	D3
70	GK/GP	50 ... 1000	69	58.6	16.5	30	45	29	39	1	38	6	≈13
	GV/GQ	50 ... 900											
80	GK/GP	< 1,477	82	72.6	22	40	60	35	46.75	1	48	8	∅18
		≥ 1,477											
120	GK/GP	< 1,377	120	107	33	80	40	64	78	1	62	12	∅28
		≥ 1,377											
185	GK/GP	< 1,604	186	169	53	120	80	80	114	1	95	25	∅44
		≥ 1,604											
	GV/GQ	< 2,361											
		≥ 2,361											
	GV/GQ	< 2,261											
		≥ 2,261											

Spindle axes EGC-BS-KF, with recirculating ball bearing guide

Technical data

Size	Variant	Stroke	D4	D5 ∅ H7	D6	D8 ∅ H7	H1	H2	H3	H5	H6	H7	L1	L2
70	GK/GP	50 ... 1000	M5	-	M5	5	64	22.5	50.5	13	13	36	168	86.5
	GV/GQ	50 ... 900											268	136.5
80	GK/GP	< 1,477	M5	9	M5	5	76.5	27	62	17.5	15	46	196	101
		≥ 1,477											236	121
	GV/GQ	< 1,377											296	151
		≥ 1,377											336	171
120	GK/GP	< 1,704	M6	-	M8	9	111.5	42.5	89.5	22	22	54	309	156
		≥ 1,704											369	186
	GV/GQ	< 1,604											409	206
		≥ 1,604											469	236
185	GK/GP	< 2,361	M8	-	M10	9	172.5	65.2	141.5	25	25	80	412	209
		≥ 2,361											512	259
	GV/GQ	< 2,261											512	259
		≥ 2,261											612	309

Size	Variant	Stroke	L3	L4	L5	L6	L7	L8	L9	T1	T2	T6	T7	T9
70	GK/GP	50 ... 1000	21	8	14	1.8	16	3	10.5	2.5	12	-	10	3.1
	GV/GQ	50 ... 900												
80	GK/GP	< 1,477	23	12.5	18	2	17	3	13	2.5	12	2.1	10	3.1
		≥ 1,477												
	GV/GQ	< 1,377												
		≥ 1,377												
120	GK/GP	< 1,704	33	17.5	25.5	2	30	3	18	3	15	-	16	2.1
		≥ 1,704												
	GV/GQ	< 1,604												
		≥ 1,604												
185	GK/GP	< 2,361	43	23	30.5	2	37	3	21	3	20	-	20	2.1
		≥ 2,361												
	GV/GQ	< 2,261												
		≥ 2,261												



Note

Flatness of the bearing surface and the attachments. The use in parallel constructions. → www.festo.com

Spindle axes EGC-BS-KF, with recirculating ball bearing guide

Technical data

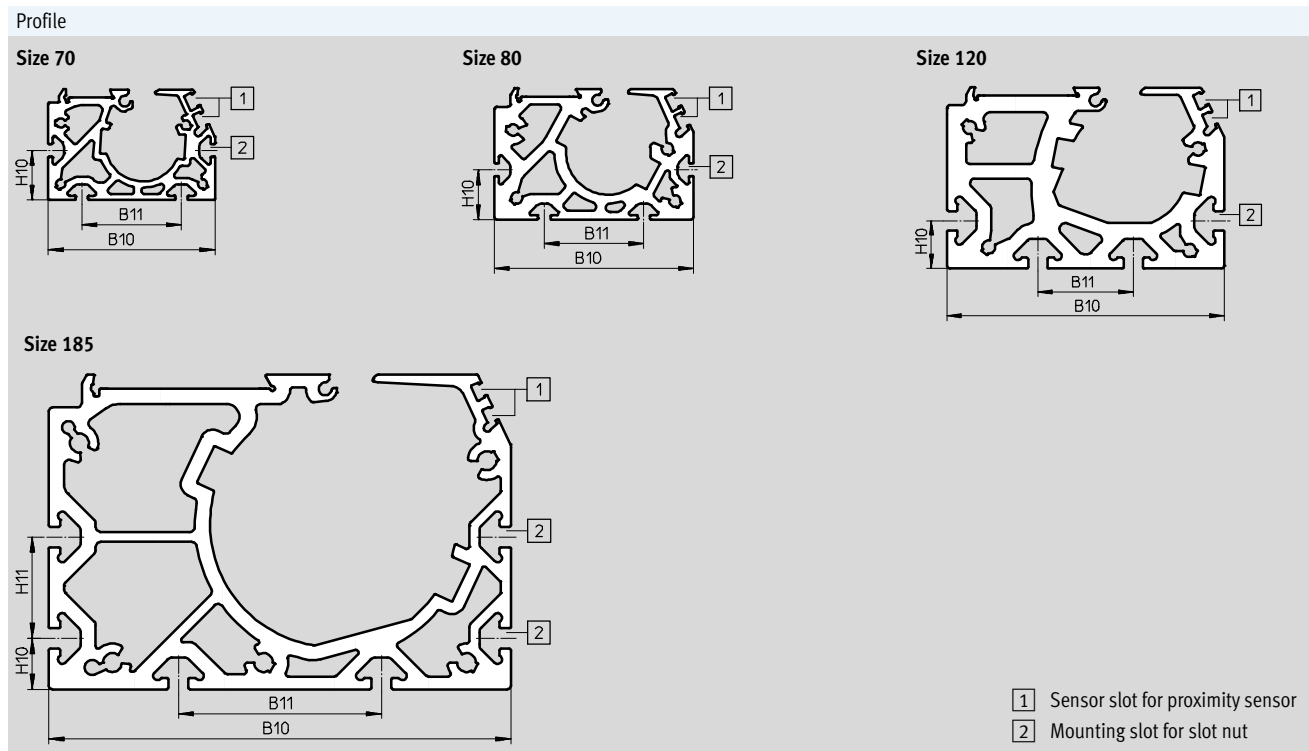

Size	B10	B11	H10	H11
70	67	40	20	-
80	80	40	20	-
120	116	40	20	-
185	182	80	20	40

Spindle axes EGC-BS-KF, with recirculating ball bearing guide

Technical data

Dimensions

Download CAD data → www.festo.com

GK – Standard slide/GP – Standard slide, protected

Size 70

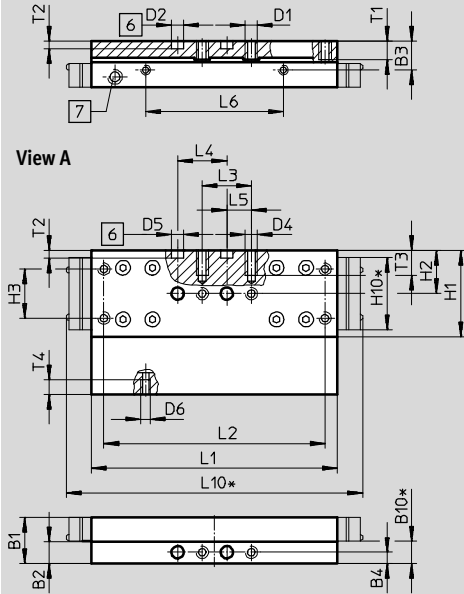

Size 80

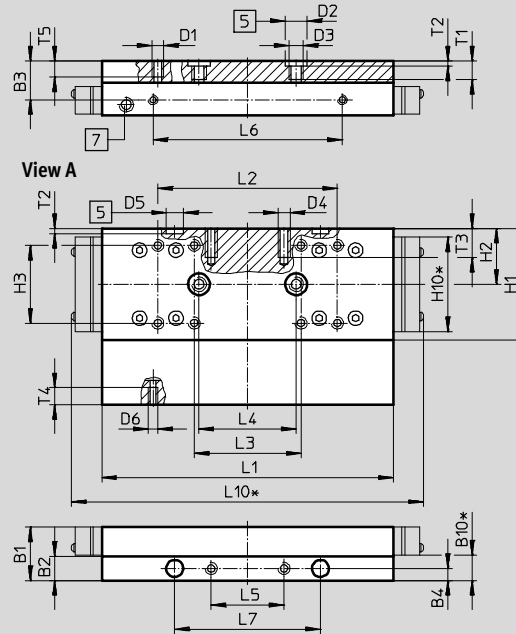

- 5 Hole for centring sleeve
- 6 Hole for centring pin
- 7 Lubricating hole for spindle
M6 threaded connection, 8 mm deep
- * Protected version

Size	B1	B2	B3	B4	B10*	D1	D2 ∅ H7	D3	D4	D5 ∅ H7	D6	H1	H2	H3
70	18.7	8.7	11.7	4.5	9	M5	5	–	M5	5	M4	35	17.5	20 ±0.1
80	22	10	16	5	10.4	M5	9	M6	M5	7	M4	46	23	32 ±0.2

Size	H10*	L1	L2	L3	L4	L5	L6	L7	L10*	T1	T2	T3	T4	T5
		±0.1			±0.03		±0.1	±0.05			+0.1			
70	29.4	100	90 ±0.1	20 ±0.1	20	10 ±0.1	56	–	121	7.5	3.1	10	6	–
80	39	120	74 ±0.2	44 ±0.2	40	30 ±0.1	78	60	145	8.6	2.1	12	7	7.5

* Protected version

Spindle axes EGC-BS-KF, with recirculating ball bearing guide



Technical data

Dimensions Download CAD data → www.festo.com

GK – Standard slide/GP – Standard slide, protected

Size 120

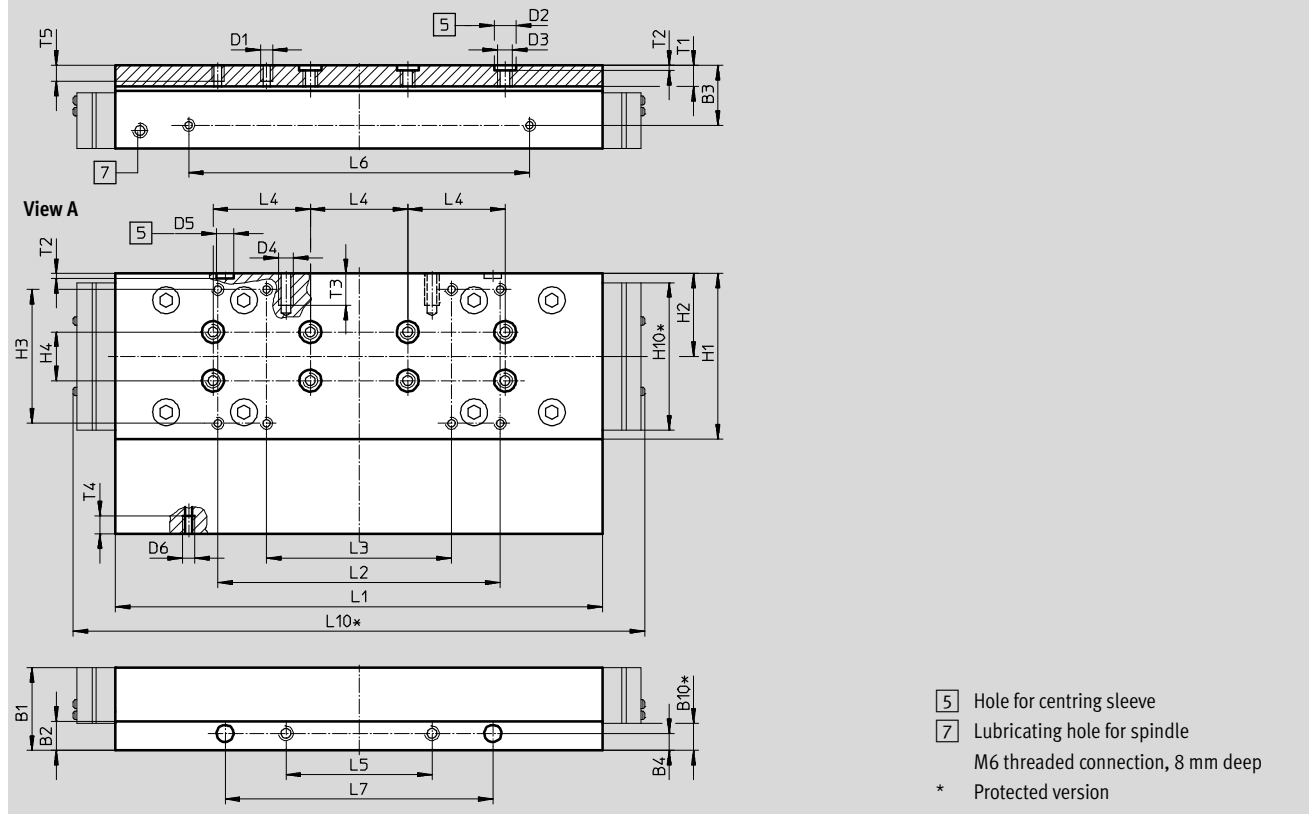

Size	B1	B2	B3	B4	B10*	D1	D2 ∅ H7	D3	D4	D5 ∅ H7	D6	H1	H2	H3	H4 ±0.03
120	34	12	24.5	7	11.2	M5	9	M6	M6	7	M5	68	34	55 ±0.2	20

Size	H10*	L1	L2	L3	L4	L5	L6	L7	L10*	T1	T2	T3	T4	T5
120	60.6	±0.1	±0.2	±0.2	±0.03	±0.1	±0.1	±0.05	235	8.6	+0.1	13	7.5	7.5

* Protected version

Spindle axes EGC-BS-KF, with recirculating ball bearing guide

Technical data

Dimensions

Download CAD data → www.festo.com

GK – Standard slide

Size 185

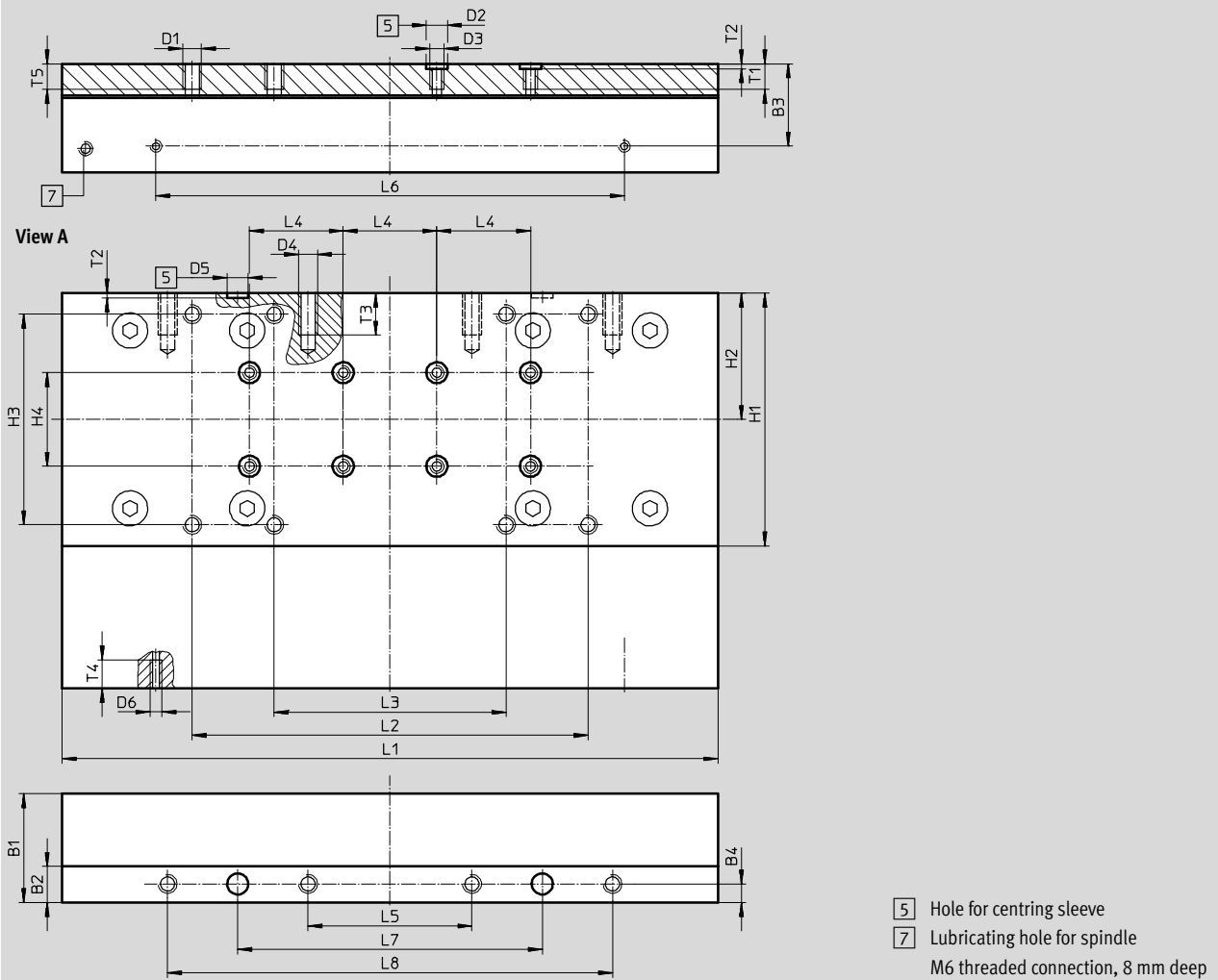

Size	B1	B2	B3	B4	D1	D2 ∅ H7	D3	D4	D5 ∅ H7	D6	H1	H2	H3 ±0.2	H4 ±0.03
185	46.5	15.5	35.2	8	M8	9	M6	M8	9	M5	108	54	90	40

Size	L1	L2	L3	L4	L5	L6	L7	L8	T1	T2 +0.1	T3	T4	T5
185	282.8	169	99	40	70	200	130	190	11	2.1	18	12.3	12

Spindle axes EGC-BS-KF, with recirculating ball bearing guide

Technical data

Dimensions Download CAD data → www.festo.com

GV – Extended slide/GQ – Extended slide, protected

Size 70

View A

- 6 Hole for centring pin
- 7 Lubricating hole for spindle
- M6 threaded connection, 8 mm deep
- * Protected version

Size	B1	B2	B3	B4	B10*	D1	D2 Ø H7	D4	D5 Ø H7
70	18.7	8.7	11.7	4.5	9	M5	5	M5	5

Size	D6	H1	H2	H3	H10*	L1	L2	L3	L4
				±0.1		±0.1	±0.1	±0.1	±0.03
70	M4	35	17.5	20	29.4	200	90	20	20

Size	L5	L6	L7	L8	L10*	T1	T2	T3	T4
	±0.1	±0.1	±0.1	±0.2			+0.1		
70	10	56	40	190	221	7.5	3.1	10	6

* Protected version

Spindle axes EGC-BS-KF, with recirculating ball bearing guide

Technical data

Dimensions Download CAD data → www.festo.com

GV – Extended slide/GQ – Extended slide, protected

Size 80

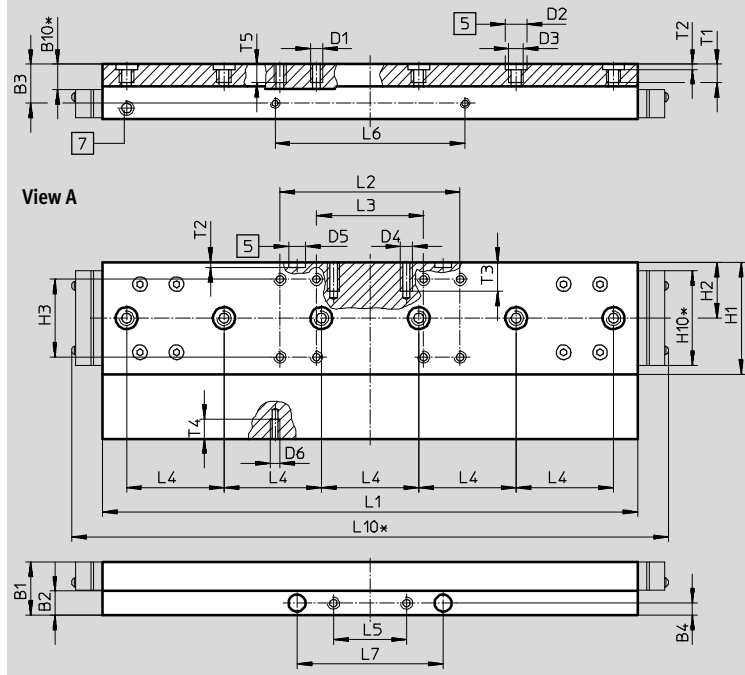

- 5 Hole for centring sleeve
- 7 Lubricating hole for spindle
M6 threaded connection, 8 mm deep
- * Protected version

Size	B1	B2	B3	B4	B10*	D1	D2 ∅	D3	D4	D5 ∅
80	22	10	16	5	10.4	M5	9 H7	M6	M5	7 H7

Size	D6	H1	H2	H3	H10*	L1	L2	L3	L4
80	M4	46	23	±0.2 32	39	±0.1 220	±0.2 74	±0.2 44	±0.03 40

Size	L5	L6	L7	L10*	T1	T2	T3	T4	T5
80	±0.1 30	±0.1 78	±0.05 60	245	8.6	+0.1 2.1	12	7	7.5

* Protected version

Spindle axes EGC-BS-KF, with recirculating ball bearing guide

Technical data

Dimensions Download CAD data → www.festo.com

GV – Extended slide/GQ – Extended slide, protected

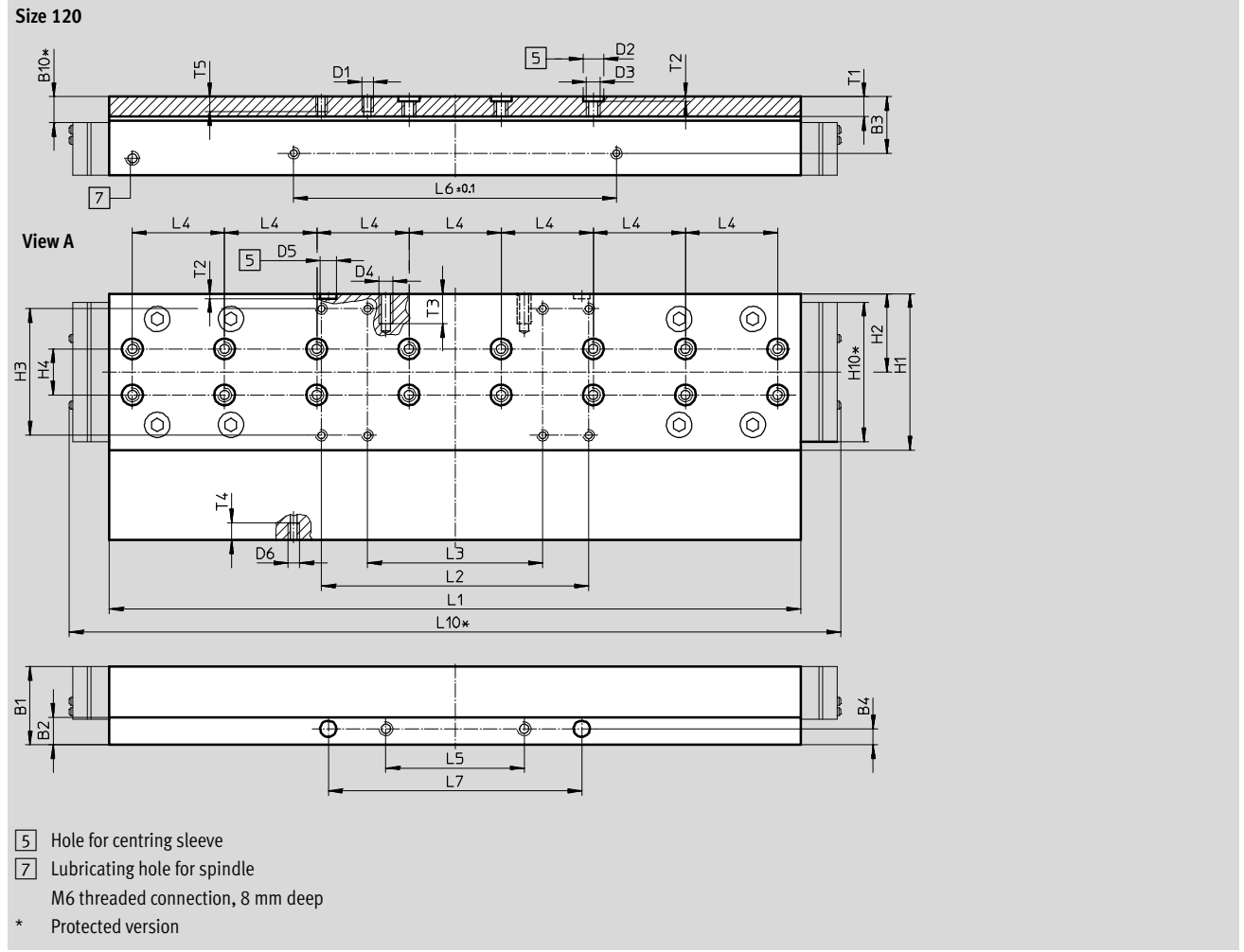

Size	B1	B2	B3	B4	B10*	D1	D2 ∅ H7	D3	D4	D5 ∅ H7
120	34	12	24.5	7	11.2	M5	9	M6	M6	7

Size	D6	H1	H2	H3	H4	H10*	L1	L2	L3	L4
					±0.03		±0.1			±0.03
120	M5	68	34	55 ±0.2	20	60.6	303.3	116 ±0.2	76 ±0.2	40

Size	L5	L6	L7	L8	L10*	T1	T2	T3	T4	T5
	±0.1	±0.1		±0.2			±0.1			
120	60	140	110 ±0.05	–	335	8.6	2.1	13	7.5	7.5

* Protected version

Spindle axes EGC-BS-KF, with recirculating ball bearing guide

Technical data

Dimensions

Download CAD data → www.festo.com

GV – Extended slide

Size 185

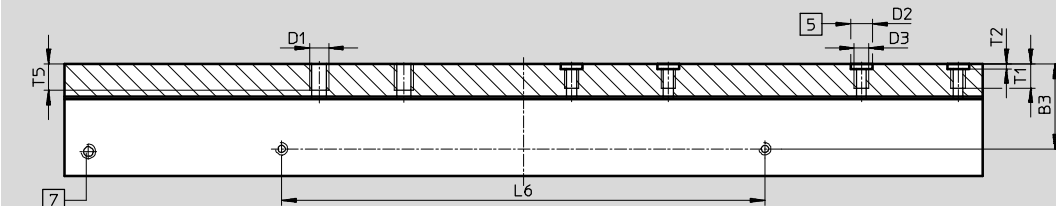

View A

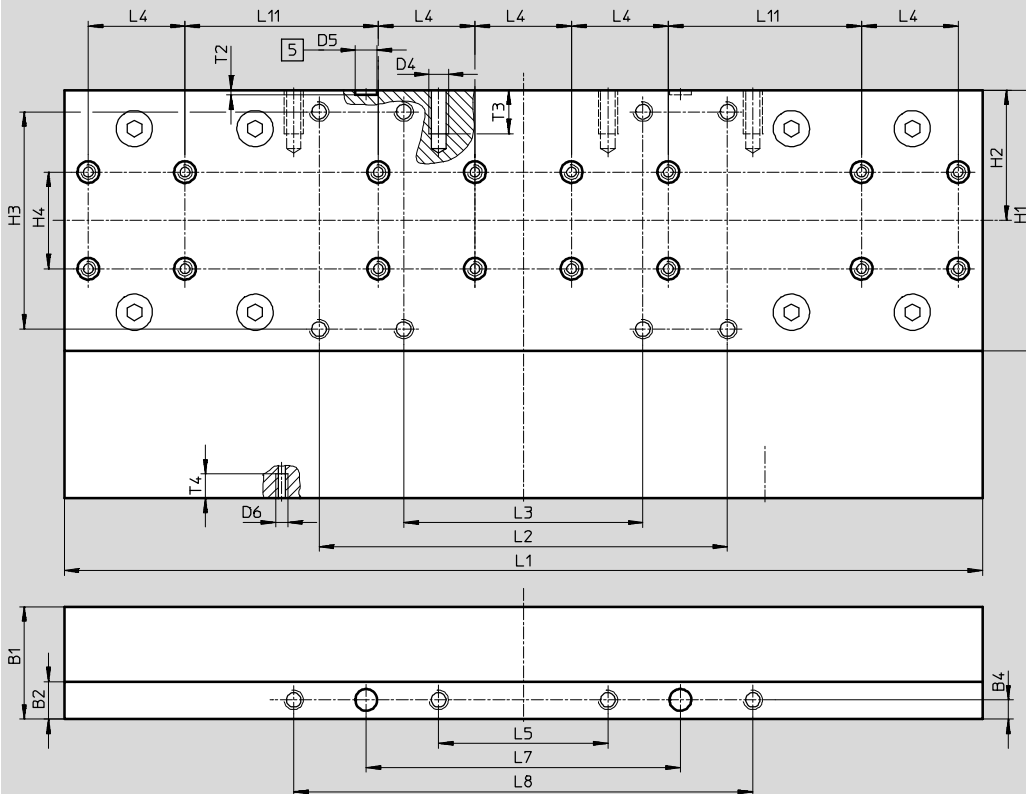

- 5 Hole for centring sleeve
- 7 Lubricating hole for spindle
M6 threaded connection, 8 mm deep

Size	B1	B2	B3	B4	D1	D2 ∅ H7	D3	D4	D5 ∅ H7
185	46.5	15.5	35.2	8	M8	9	M6	M8	9

Size	D6	H1	H2	H3	H4	L1	L2	L3	L4	
185	M5	108	54	90	±0.2	±0.03	±0.1	±0.2	±0.2	±0.03

Size	L5	L6	L7	L8	L11	T1	T2	T3	T4	T5
185	±0.2	±0.1	±0.05	±0.2	±0.03	11	+0.1	18	10	12

Spindle axes EGC-BS-KF, with recirculating ball bearing guide

Technical data



Dimensions

Download CAD data → www.festo.com

GK-C – Standard slide with lubrication adapter

Size 80

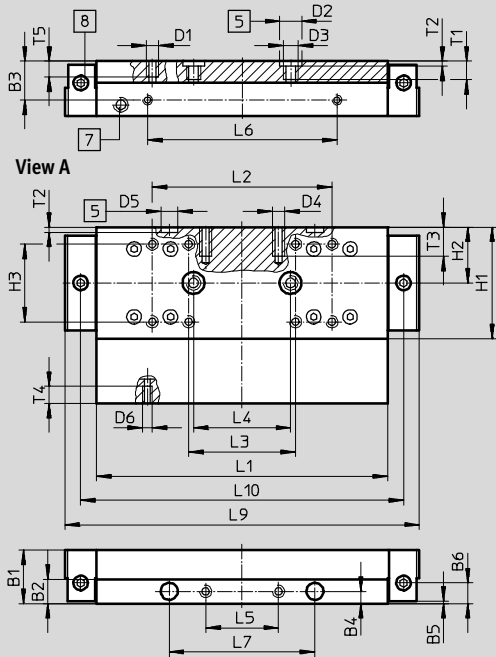

Size 120

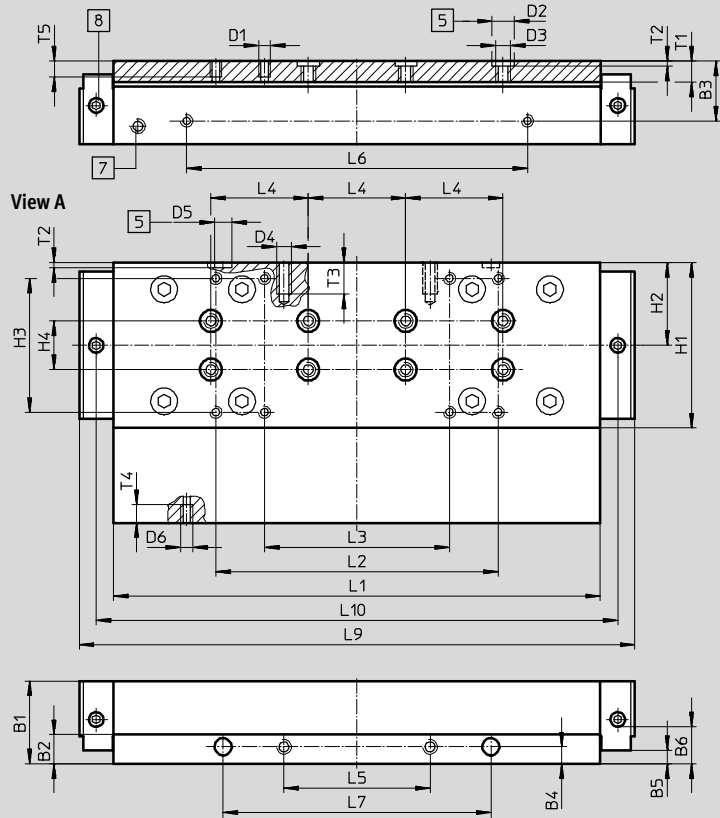

- 5 Hole for centring sleeve
- 7 Lubricating hole for spindle
M6 threaded connection, 8 mm deep
- 8 Lubricating hole for lubrication adapter
M6 threaded connection, 6 mm deep

Size	B1	B2	B3	B4	B5	B6	D1	D2	D3	D4
					±0.1			∅ H7		
80	22	10	16	5	1	8.5	M5	9	M6	M5
120	34	12	24.5	7	5.5	18.2	M5	9	M6	M6

Size	D5	D6	H1	H2	H3	H4	L1	L2	L3	L4
	∅ H7				±0.2	±0.03	±0.1	±0.2	±0.2	±0.03
80	7	M4	46	23	32	–	120	74	44	40
120	7	M5	68	34	55	20	203.3	116	76	40

Size	L5	L6	L7	L9	L10	T1	T2	T3	T4	T5
	±0.1	±0.1	±0.05				+0.1			
80	30	78	60	146	133	8.6	2.1	12	7	7.5
120	60	140	110	226.9	214.3	8.6	2.1	13	7.5	7.5

Spindle axes EGC-BS-KF, with recirculating ball bearing guide

Technical data

Dimensions

Download CAD data → www.festo.com

GK-C – Standard slide with lubrication adapter

Size 185

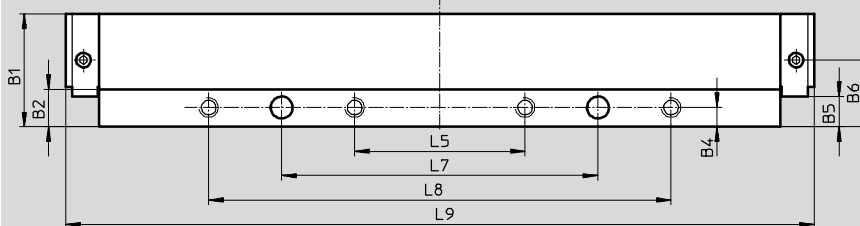
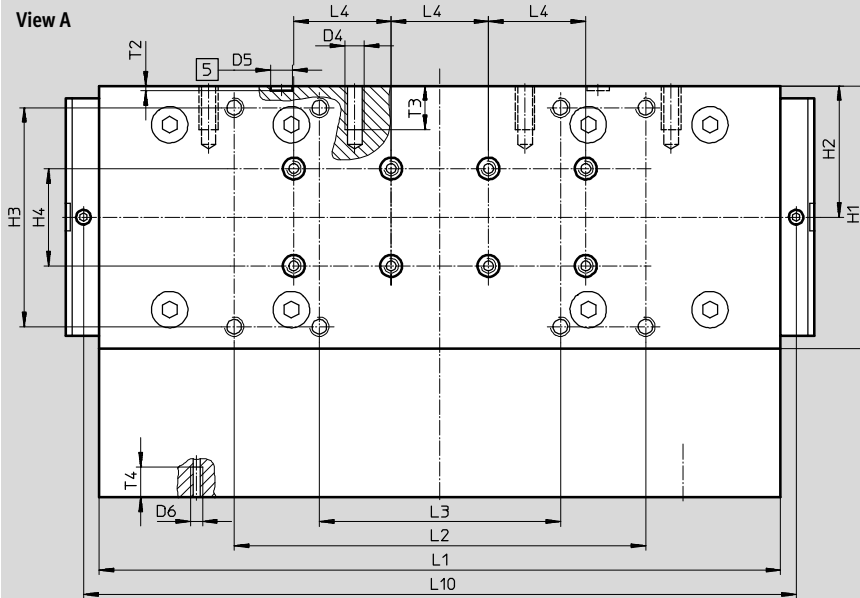
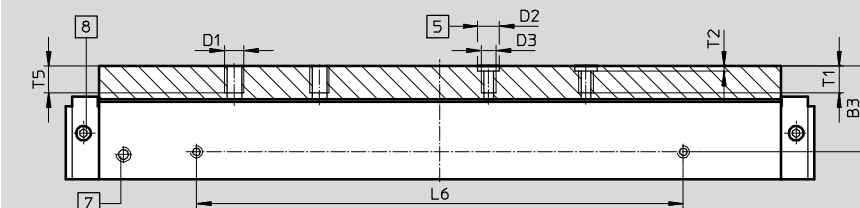

- 5 Hole for centring sleeve
- 7 Lubricating hole for spindle
M6 threaded connection, 8 mm deep
- 8 Lubricating hole for lubrication adapter
M6 threaded connection, 6 mm deep

Size	B1	B2	B3	B4	B5	B6	D1	D2	D3	D4
185	46.5	15.5	35.2	8	±0.1 12.5	27.5	M8	∅ H7 9	M6	M8

Size	D5	D6	H1	H2	H3	H4	L1	L2	L3	L4
185	∅ H7 9	M5	108	54	±0.2 90	±0.03 40	±0.1 282.8	±0.2 169	±0.2 99	±0.03 40

Size	L5	L6	L7	L8	L9	L10	T1	T2	T3	T4	T5
185	±0.2 70	±0.1 200	±0.05 130	±0.2 190	307.4	292.8	11	+0.1 2.1	18	12.3	12

Spindle axes EGC-BS-KF, with recirculating ball bearing guide

Technical data

Dimensions Download CAD data → www.festo.com

GV-C – Extended slide with lubrication adapter

Size 80

View A

- 5 Hole for centring sleeve
- 7 Lubricating hole for spindle
M6 threaded connection, 8 mm deep
- 8 Lubricating hole for lubrication adapter
M6 threaded connection, 6 mm deep

Size	B1	B2	B3	B4	B5	B6	D1	D2	D3	D4
					±0.1			∅ H7		
80	22	10	16	5	1	8.5	M5	9	M6	M5

Size	D5	D6	H1	H2	H3	L1	L2	L3	L4	L5
	∅ H7				±0.2	±0.1	±0.2	±0.2	±0.03	±0.1
80	7	M4	46	23	32	220	74	44	40	30

Size	L6	L7	L9	L10	T1	T2	T3	T4	T5
	±0.1	±0.05				+0.1			
80	78	60	246	233	8.6	2.1	12	7	7.5

Spindle axes EGC-BS-KF, with recirculating ball bearing guide

Technical data

Dimensions

Download CAD data → www.festo.com

GV-C – Extended slide with lubrication adapter

Size 120

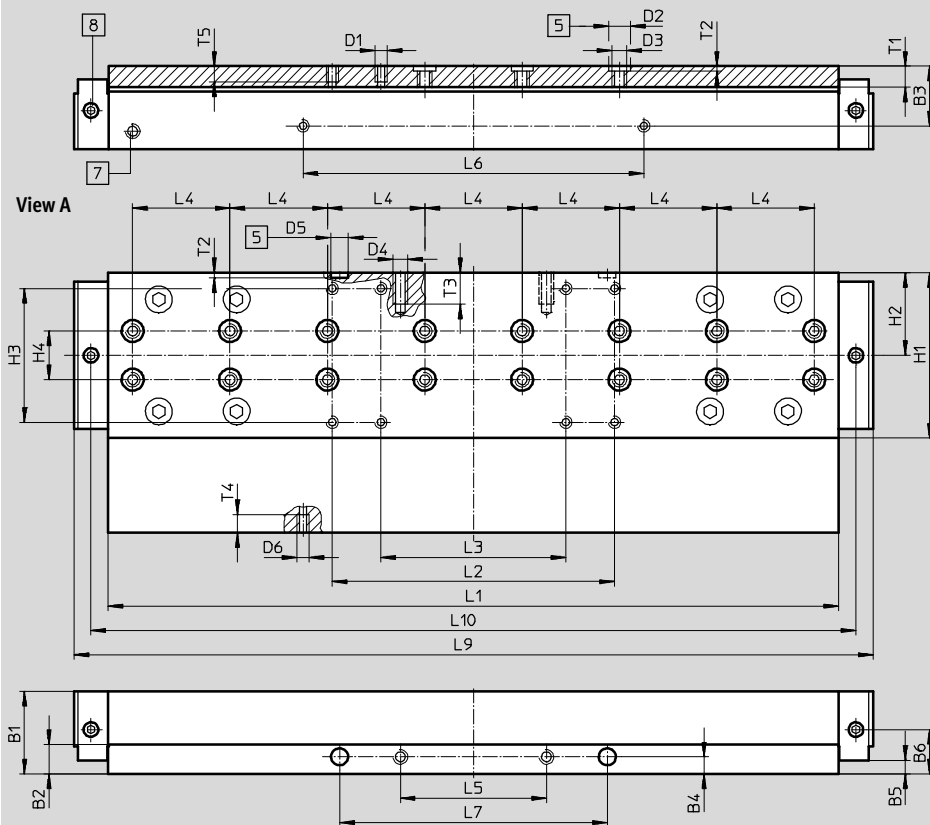

- 5 Hole for centring sleeve
- 7 Lubricating hole for spindle
M6 threaded connection, 8 mm deep
- 8 Lubricating hole for lubrication adapter
M6 threaded connection, 6 mm deep

Size	B1	B2	B3	B4	B5	B6	D1	D2 ∅ H7	D3	D4
120	34	12	24.5	7	±0.1 5.5	18.2	M5	9	M6	M6

Size	D5 ∅ H7	D6	H1	H2	H3	H4	L1	L2	L3	L4
120	±0.2 7	M5	68	34	±0.2 55	±0.03 20	±0.1 303.3	±0.2 116	±0.2 76	±0.03 40

Size	L5	L6	L7	L9	L10	T1	T2	T3	T4	T5
120	±0.1 60	±0.1 140	±0.05 110	326.9	314.3	8.6	+0.1 2.1	13	7.5	7.5

Spindle axes EGC-BS-KF, with recirculating ball bearing guide

Technical data



Dimensions

Download CAD data → www.festo.com

GV-C – Extended slide with lubrication adapter

Size 185

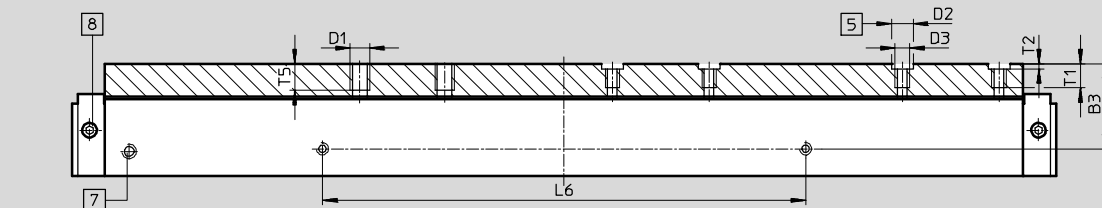

View A

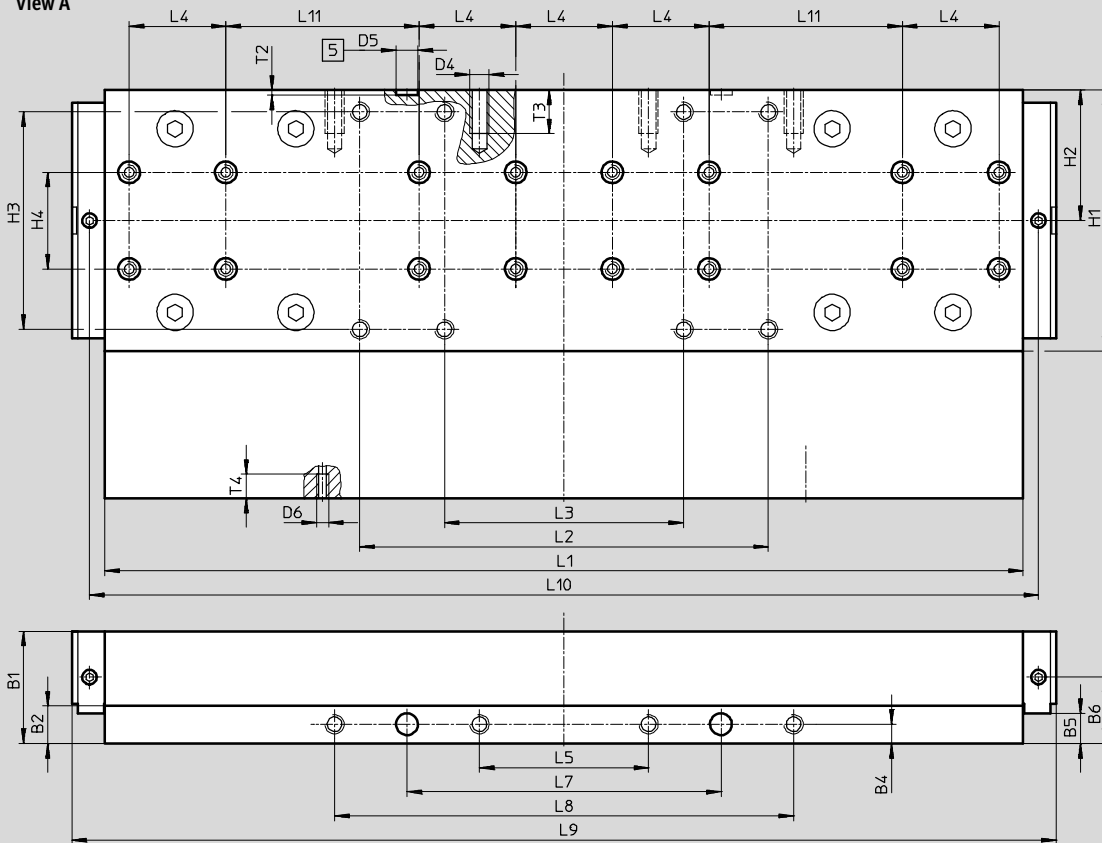

- 5 Hole for centring sleeve
- 7 Lubricating hole for spindle
M6 threaded connection, 8 mm deep
- 8 Lubricating hole for lubrication adapter
M6 threaded connection, 6 mm deep

Size	B1	B2	B3	B4	B5	B6	D1	D2 ∅ H7	D3	D4
185	46.5	15.5	35.2	8	±0.1 12.5	27.5	M8	9	M6	M8

Size	D5 ∅ H7	D6	H1	H2	H3	H4	L1	L2	L3	L4	L5
185	9	M5	108	54	±0.2 90	±0.03 40	±0.1 382.8	±0.2 169	±0.2 99	±0.03 40	±0.2 70

Size	L6	L7	L8	L9	L10	L11	T1	T2	T3	T4	T5
185	±0.1 200	±0.05 130	±0.2 190	407.4	392.8	±0.03 80	11	+0.1 2.1	18	10	12

Spindle axes EGC-BS-KF, with recirculating ball bearing guide

Technical data

Dimensions

Download CAD data → www.festo.com

M1/M2 – With incremental encoder

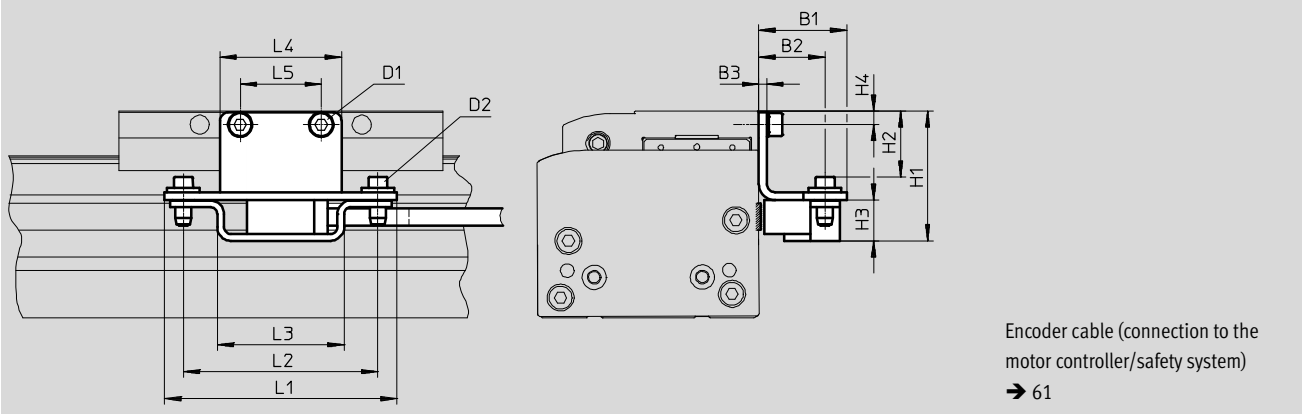

Type	B1	B2	B3	H1	H2	H3	H4
EGC-70-...-M1	32.5	24.5	3	39	18.4	15	4.5
EGC-70-...-M2				39	18.4		4.5
EGC-80-...-M1				48	24.4		5
EGC-80-...-M2				48	24.4		5
EGC-120-...-M1				60	36.4		7
EGC-120-...-M2				60	36.4		7
EGC-185-...-M1				78.5	54.9		8
EGC-185-...-M2				78.5	54.9		8

Type	D1	D2	L1	L2	L3	L4	L5
EGC-70-...-M1	M5x8	M4x14	86	72	47	35	20
EGC-70-...-M2	M5x8					35	20
EGC-80-...-M1	M5x8					45	30
EGC-80-...-M2	M5x8					45	30
EGC-120-...-M1	M6x10					86	60
EGC-120-...-M2	M6x10					86	60
EGC-185-...-M1	M8x12					86	70
EGC-185-...-M2	M8x12					86	70

Spindle axes EGC-BS-KF, with recirculating ball bearing guide

Technical data

Dimensions

Download CAD data → www.festo.com

1HL/1HR/2H – With clamping unit

Size 80

1-channel, left

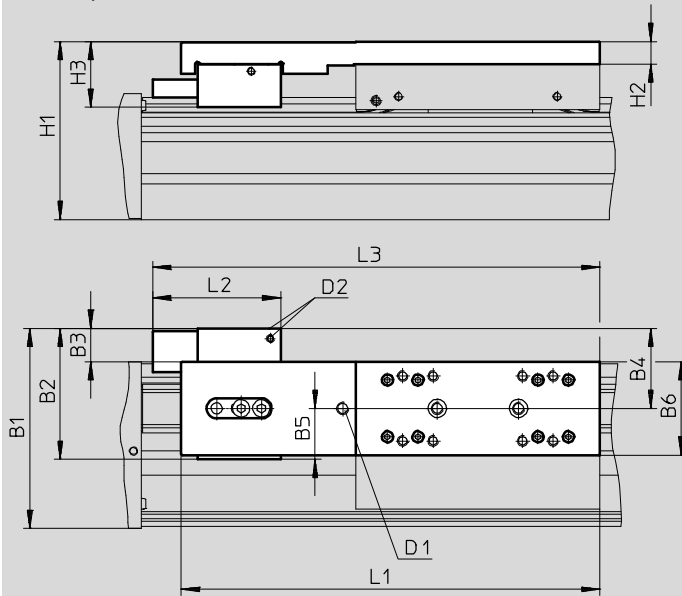

1-channel, right

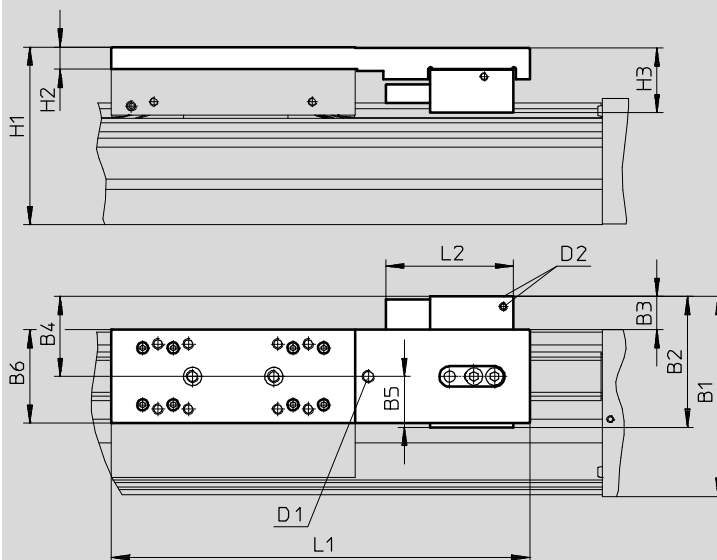

D2 Compressed air supply

Working stroke reduction in combination with additional slide

→ 21

Spindle axes EGC-BS-KF, with recirculating ball bearing guide

Technical data



Dimensions

Download CAD data → www.festo.com

1HL/1HR/2H – With clamping unit

Size 80

2-channel

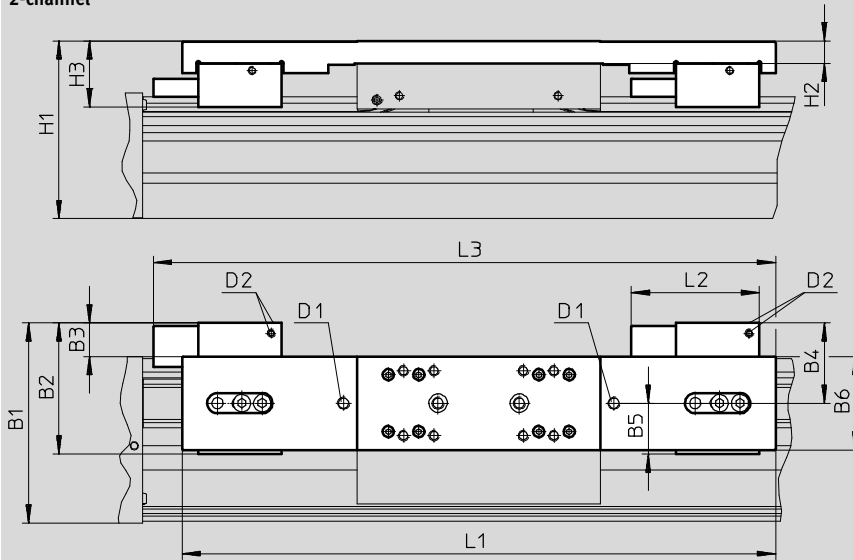

D2 Compressed air supply

Working stroke reduction in combination with additional slide → 21

Type	B1	B2	B3	B4	B5	B6	H1	H2	H3	D1	D2	L1	L2	L3											
EGC-80-...-1HL-PN	98.4	64.4	17.4	39.4	25	46	87.5	11	32.4	M6	M5	206	63	220											
EGC-80-...-1HR-PN														-											
EGC-80-...-C-1HL-PN														220											
EGC-80-...-C-1HR-PN														-											
EGC-80-...-2H-PN												292													306
EGC-80-...-C-2H-PN																									

Spindle axes EGC-BS-KF, with recirculating ball bearing guide

Technical data

Dimensions

Download CAD data → www.festo.com

1HL/1HR/2H – With clamping unit

Size 120/185

1-channel, left

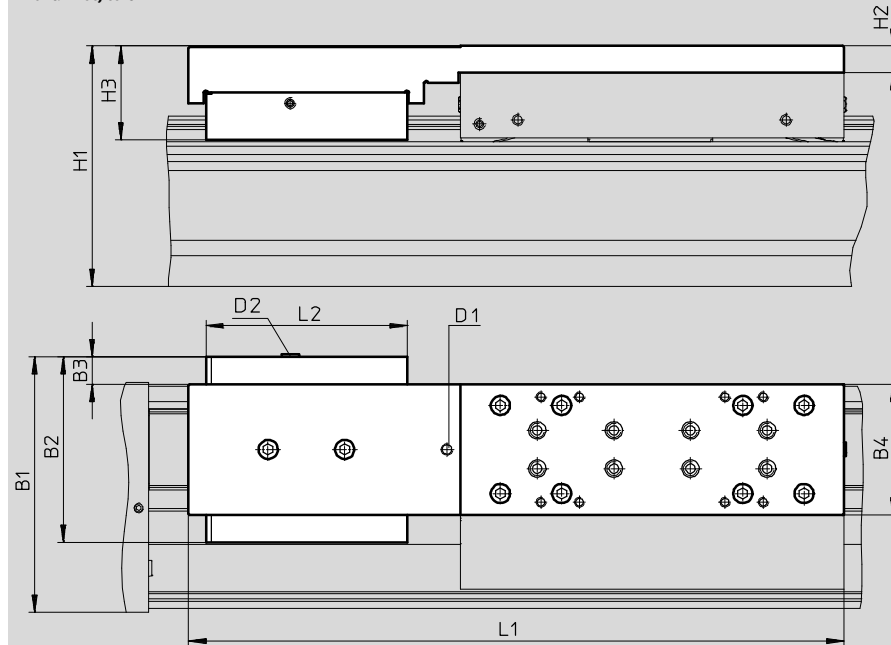

1-channel, right

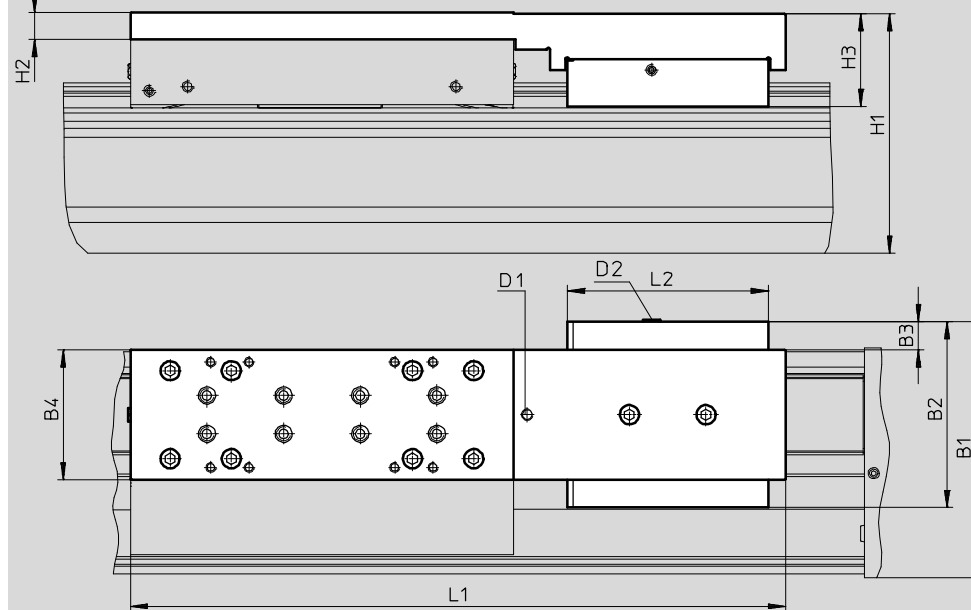

D2 Compressed air supply

Working stroke reduction in combination with additional slide → 21

Spindle axes EGC-BS-KF, with recirculating ball bearing guide

Technical data

Dimensions Download CAD data → www.festo.com

1HL/1HR/2H – With clamping unit

Size 120/185

2-channel

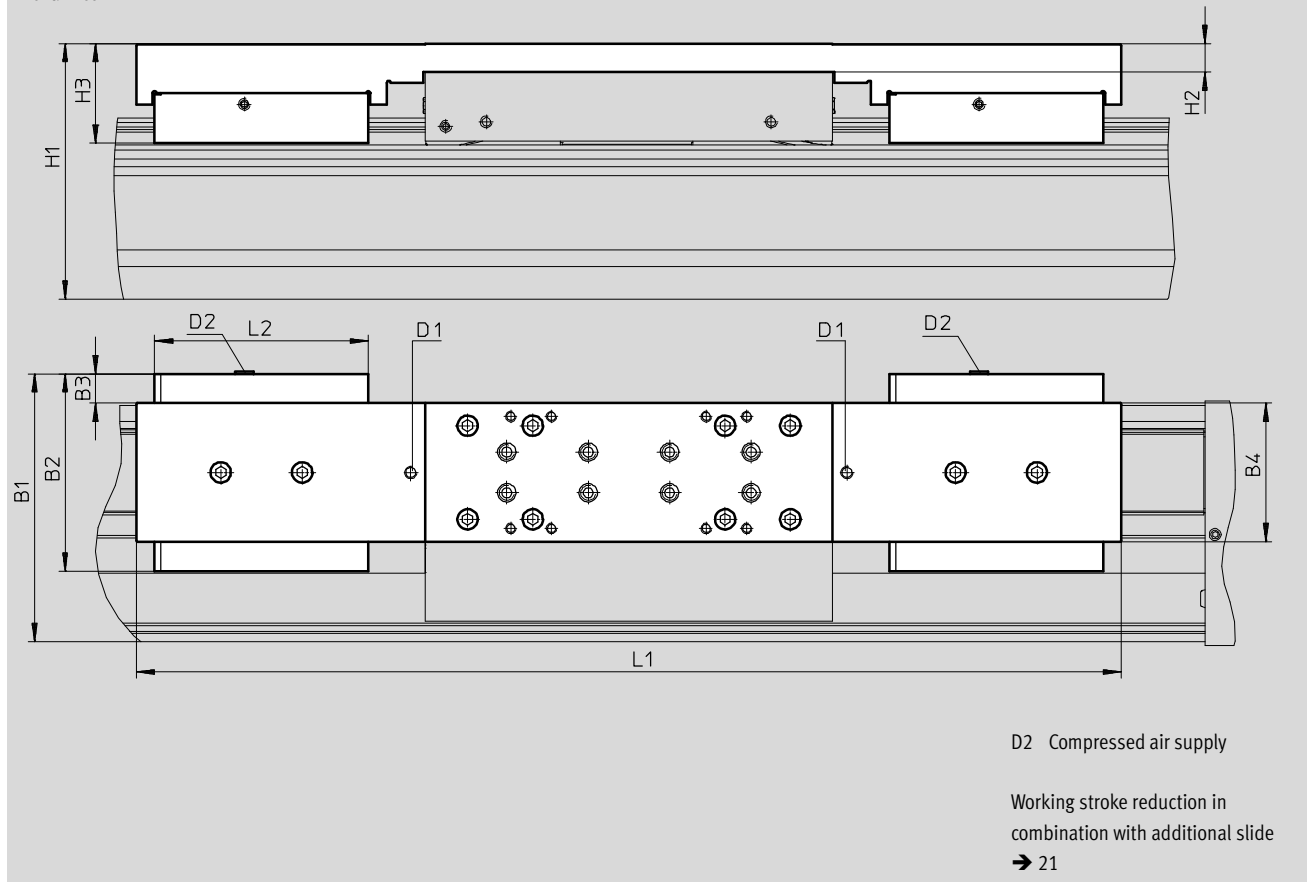

Type	B1	B2	B3	B4	H1	H2	H3	D1	D2	L1	L2
Size 120											
EGC-120-...-1HL-PN	133.5	97	15.5	68	125.5	14	48.9	M6	M5	342	105
EGC-120-...-1HR-PN											
EGC-120-...-C-1HL-PN											
EGC-120-...-C-1HR-PN											
EGC-120-...-2H-PN											
EGC-120-...-C-2H-PN										484	
Size 185											
EGC-185-...-1HL-PN	196.5	131	12.5	108	189.5	17	64.1	M6	M5	432	109
EGC-185-...-1HR-PN											
EGC-185-...-C-1HL-PN											
EGC-185-...-C-1HR-PN											
EGC-185-...-2H-PN											
EGC-185-...-C-2H-PN										584	

Spindle axes EGC-BS-KF, with recirculating ball bearing guide

Technical data

Ordering data – Stock items

Features:

- Stroke reserve: 0 mm
- Motor attachment position:
on the left
- Standard slide

Size	Stroke [mm]	Part No.	Type
70	Spindle pitch 10 mm/U		
	100	3013388	EGC-70-100-BS-10P-KF-0H-ML-GK
	200	3013389	EGC-70-200-BS-10P-KF-0H-ML-GK
	300	3013390	EGC-70-300-BS-10P-KF-0H-ML-GK
	400	3013391	EGC-70-400-BS-10P-KF-0H-ML-GK
	500	3013392	EGC-70-500-BS-10P-KF-0H-ML-GK
	600	3013393	EGC-70-600-BS-10P-KF-0H-ML-GK
80	Spindle pitch 10 mm/U		
	100	3013532	EGC-80-100-BS-10P-KF-0H-ML-GK
	200	3013533	EGC-80-200-BS-10P-KF-0H-ML-GK
	300	3013534	EGC-80-300-BS-10P-KF-0H-ML-GK
	400	3013535	EGC-80-400-BS-10P-KF-0H-ML-GK
	500	3013536	EGC-80-500-BS-10P-KF-0H-ML-GK
	600	3013537	EGC-80-600-BS-10P-KF-0H-ML-GK
	800	3013538	EGC-80-800-BS-10P-KF-0H-ML-GK
	Spindle pitch 20 mm/U		
	100	3013539	EGC-80-100-BS-20P-KF-0H-ML-GK
	200	3013540	EGC-80-200-BS-20P-KF-0H-ML-GK
	300	3013541	EGC-80-300-BS-20P-KF-0H-ML-GK
	400	3013542	EGC-80-400-BS-20P-KF-0H-ML-GK
	500	3013543	EGC-80-500-BS-20P-KF-0H-ML-GK
	600	3013544	EGC-80-600-BS-20P-KF-0H-ML-GK
	800	3013545	EGC-80-800-BS-20P-KF-0H-ML-GK
	120	Spindle pitch 10 mm/U	
100		3013571	EGC-120-100-BS-10P-KF-0H-ML-GK
200		3013572	EGC-120-200-BS-10P-KF-0H-ML-GK
300		3013573	EGC-120-300-BS-10P-KF-0H-ML-GK
400		3013574	EGC-120-400-BS-10P-KF-0H-ML-GK
500		3013575	EGC-120-500-BS-10P-KF-0H-ML-GK
600		3013576	EGC-120-600-BS-10P-KF-0H-ML-GK
800		3013577	EGC-120-800-BS-10P-KF-0H-ML-GK
Spindle pitch 25 mm/U			
100		3013578	EGC-120-100-BS-25P-KF-0H-ML-GK
200		3013579	EGC-120-200-BS-25P-KF-0H-ML-GK
300		3013580	EGC-120-300-BS-25P-KF-0H-ML-GK
400		3013581	EGC-120-400-BS-25P-KF-0H-ML-GK
500		3013582	EGC-120-500-BS-25P-KF-0H-ML-GK
600		3013583	EGC-120-600-BS-25P-KF-0H-ML-GK
800		3013584	EGC-120-800-BS-25P-KF-0H-ML-GK

Spindle axes EGC-BS-KF, with recirculating ball bearing guide

Ordering data – Modular products

Order code

Mandatory data

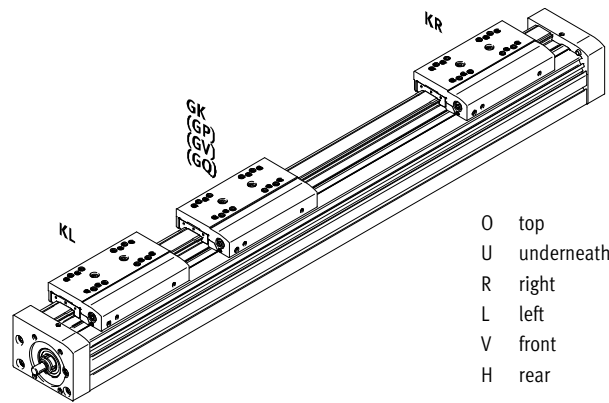
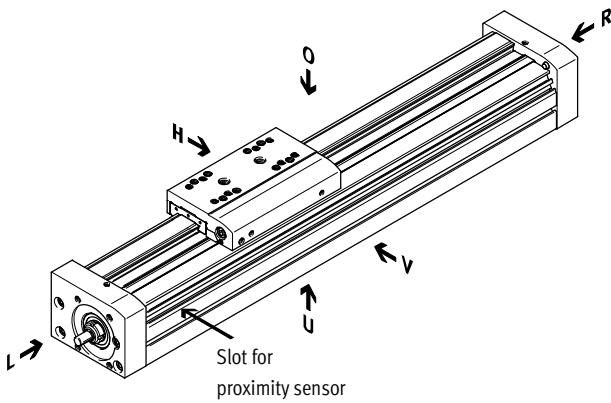

- O top
- U underneath
- R right
- L left
- V front
- H rear

Accessories

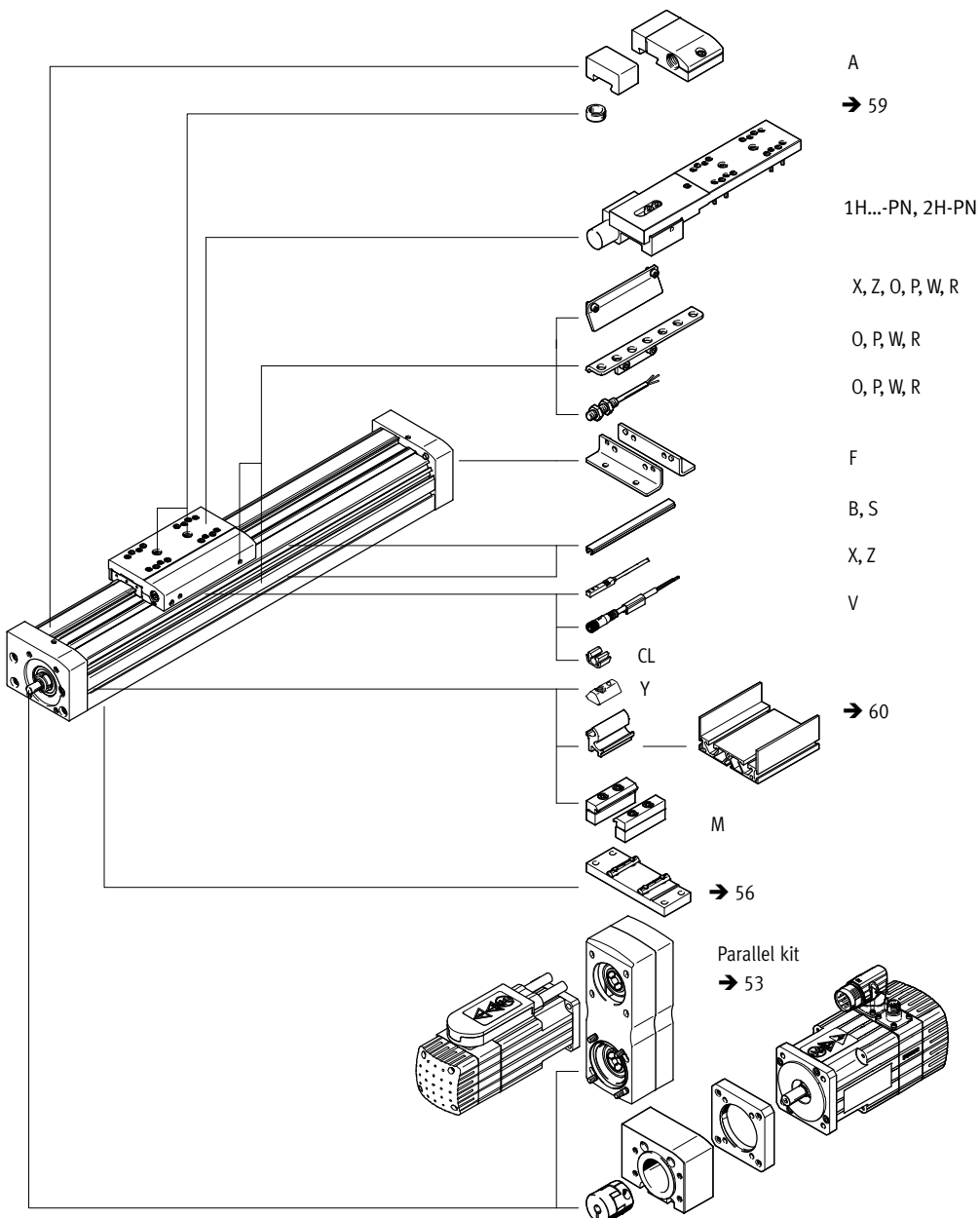

Spindle axes EGC-BS-KF, with recirculating ball bearing guide

Ordering data – Modular products

Ordering table							
Size	70	80	120	185	Condi- tions	Code	Enter code
M Module No.	556807	556808	556809	556811			
Design	Linear axis					EGC	EGC
Size	70	80	120	185		-...	
Stroke for GK, GP (without stroke reserve) [mm]	100; 200; 300; 400; 500; 600; 700; 800; 1000	100; 200; 300; 500; 600; 800; 1000; 1500; 1800; 2000	200; 300; 500; 600; 800; 1000; 1400; 1500; 2000; 2500	300; 500; 600; 1000; 1500; 2000; 2500; 3000		-...	-...
Stroke for GV, GQ (without stroke reserve) [mm]	100; 200; 300; 400; 500; 600; 700; 900	100; 200; 400; 500; 700; 900; 1300; 1400; 1700; 1900	100; 200; 400; 500; 700; 900; 1300; 1400; 1900; 2400	200; 400; 500; 900; 1400; 1900; 2400; 2900		-...	
Function	Ball screw spindle					-BS	-BS
Spindle pitch	10	10	10	-		-10P	
	-	20	-	-		-20P	
	-	-	25	-		-25P	
	-	-	-	40		-40P	
Spindle support	None						
	With spindle support				1	-S	
	> 705 mm ¹⁾	> 780 mm ¹⁾	> 883 mm ¹⁾	> 1224 mm ¹⁾			
	> 605 mm ²⁾	> 680 mm ²⁾	> 783 mm ²⁾	> 1124 mm ²⁾			
Guide	Recirculating ball bearing guide					-KF	-KF
Stroke reserve [mm]	0 ... 999 (0 = no stroke reserve)				2	-...H	
Motor attachment position	Motor on the left					-ML	
	Motor on the right					-MR	
Slide	Standard slide					-GK	
	Extended slide, protected					-GQ	
	Standard slide, protected					-GP	
	Extended slide					-GV	

- 1 S** Only available above the specified strokes
 - 1) in combination with slide GK, GP
 - 2) in combination with slide GQ, GV
- 2 ...H** The sum of the stroke length and 2x stroke reserve must not exceed the maximum stroke length

 Note
Spindle support enables maximum travel speed with all stroke lengths.

- M** Mandatory data
- O** Options

Order code

EGC - - - **BS** - - - **KF** - - -

Spindle axes EGC-BS-KF, with recirculating ball bearing guide

Ordering data – Modular products

Ordering table							
Size	70	80	120	185	Condi- tions	Code	Enter code
[O] Additional slide	Left	Additional slide, standard, on left			[3]	-KL	
	Right	Additional slide, standard, on right			[3]	-KR	
Lubrication function	Standard						
	-	Lubrication adapter				-C	
Displacement encoder, incremental	Resolution: 2.5 µm					-M1	
	Resolution: 10 µm					-M2	
Clamping unit	-	1-channel, left		[4]		-1HL	
	-	1-channel, right		[4]		-1HR	
	-	2-channel		[4]		-2H	
Actuation type	-	Pneumatic				-PN	
↓ Accessories	Accessories enclosed separately					ZUB-	ZUB-
[O] Foot mounting	1					F	
Profile mounting	1 ... 50					...M	
Cover	Mounting slot	1 ... 50 (1 = 2 units, 500 mm)				...B	
	Sensor slot	1 ... 50 (1 = 2 units, 500 mm)				...S	
Slot nut for mounting slot	1 ... 99					...Y	
Proximity sensor (SIES), inductive, slot type 8, PNP, incl. switch lug	N/O contact, 7.5 m cable	1 ... 6				...X	
	N/C contact, 7.5 m cable	1 ... 6				...Z	
Emergency buffer with retainer	1 ... 2				[5]	...A	
Proximity sensor (SIEN), inductive, M8, PNP, incl. switch lug with sensor bracket	N/O contact, 2.5 m cable	1 ... 99				...O	
	N/C contact, 2.5 m cable	1 ... 99				...P	
Connecting cable 2.5 m, M8, 3-wire	N/O contact, plug M8	1 ... 99				...W	
	N/C contact, plug M8	1 ... 99				...R	
Cable clip	10, 20, 30, 40, 50, 60, 70, 80, 90					...CL	
Operating instructions	Express waiver - no operating instructions to be included (already available) (operating instructions in pdf format are available free of charge on the Internet at www.festo.com)					-DN	

- [3] **KL, KR** If the protected slide variant (GQ, GP) is selected, then the additional slide (KL, KR) is also protected
If the extended slide variant (GQ, GV) is selected, then the additional slide (KL, KR) is not extended
If the slide with lubrication adapter (GK-C, GV-C) is selected, then the additional slide (KL, KR) is also supplied with lubrication adapter
Working stroke reduction in combination with additional slide (KL, KR) → 20
- [4] **1HL, 1HR, 2H** Not with slide GQ, GV as well as additional slide KL, KR
Only with PN
Working stroke reduction in combination with clamping unit (1HL, 1HR, 2H) → 21
- [5] **... A** Emergency buffer with retainer A cannot be combined with slide GP, GQ, GK-C, GV-C and clamping unit 1H...PN, 2H-PN

 Note

The code X, Z includes a switch lug in the scope of delivery.
The code O, P, W, R includes one switch lug and max. two sensor brackets in the scope of delivery.

- [M] Mandatory data
- [O] Options

Transfer order code

- [] - [] - [] - [] - [] - [] **ZUB** - [] - []

Spindle axes EGC-BS-KF, with recirculating ball bearing guide

Accessories

-  - Note

Depending on the combination of motor and drive, it may not be possible to reach the maximum feed force of the drive.

The respective no-load driving torque of the kit must be taken into consideration when using parallel kits.

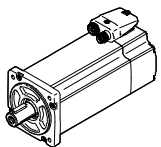
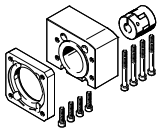
Permissible axis/motor combinations with axial kit – without gear unit		Technical data → Internet: eamm-a	
Motor ¹⁾	Axial kit		
			
Type	Part No.	Type	
EGC-70			
With servo motor			
EMME-AS-40-...	2219044	EAMM-A-S38-40P ²⁾	
	3637972	EAMM-A-S38-40P-G2	
EMMS-AS-40-...	558162	EAMM-A-S38-40A ²⁾	
	3637971	EAMM-A-S38-40A-G2	
EMMS-AS-55-...	558163	EAMM-A-S38-55A ²⁾	
	3637967	EAMM-A-S38-55A-G2	
EMME-AS-60-...	2219110	EAMM-A-S38-60P ²⁾	
	3637958	EAMM-A-S38-60P-G2	
With stepper motor			
EMMS-ST-42-...	560685	EAMM-A-S38-42A ²⁾	
	3637965	EAMM-A-S38-42A-G2	
EMMS-ST-57-...	560686	EAMM-A-S38-57A ²⁾	
	3637956	EAMM-A-S38-57A-G2	
With integrated drive			
EMCA-EC-67-...	1456638	EAMM-A-S38-67A-G2	
EGC-80			
With servo motor			
EMMS-AS-55-...	558164	EAMM-A-S48-55A ²⁾	
	3637961	EAMM-A-S48-55A-G2	
EMME-AS-60-...	2220560	EAMM-A-S48-60P ²⁾	
	3637964	EAMM-A-S48-60P-G2	
EMMS-AS-70-...	558165	EAMM-A-S48-70A ²⁾	
	3637957	EAMM-A-S48-70A-G2	
With stepper motor			
EMMS-ST-57-...	560687	EAMM-A-S48-57A ²⁾	
	3637963	EAMM-A-S48-57A-G2	
EMMS-ST-87-...	560688	EAMM-A-S48-87A ²⁾	
	3637962	EAMM-A-S48-87A-G2	

1) The input torque must not exceed the maximum permissible transferable torque of the axial kit.

2) Type discontinued

Spindle axes EGC-BS-KF, with recirculating ball bearing guide

Accessories

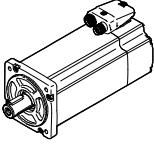
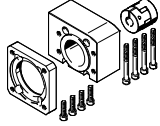
Permissible axis/motor combinations with axial kit – without gear unit		Technical data → Internet: eamm-a
Motor ¹⁾	Axial kit	
		
Type	Part No.	Type
EGC-120		
With servo motor		
EMMS-AS-70-...	558166	EAMM-A-S62-70A ²⁾
	3637959	EAMM-A-S62-70A-G2
EMME-AS-80-...	2222582	EAMM-A-S62-80P ²⁾
	3637970	EAMM-A-S62-80P-G2
EMME-AS-100-...	558167	EAMM-A-S62-100A ²⁾
	3637960	EAMM-A-S62-100A-G2
EMMS-AS-100-...	558167	EAMM-A-S62-100A ²⁾
	3637960	EAMM-A-S62-100A-G2
EMMS-AS-140-...	558168	EAMM-A-S62-140A ²⁾
	3637969	EAMM-A-S62-140A-G2
With stepper motor		
EMMS-ST-87-...	560689	EAMM-A-S62-87A ²⁾
	3637966	EAMM-A-S62-87A-G2
EGC-185		
With servo motor		
EMME-AS-100-...	558169	EAMM-A-S95-100A ²⁾
	3637955	EAMM-A-S95-100A-G2
EMMS-AS-100-...	558169	EAMM-A-S95-100A ²⁾
	3637955	EAMM-A-S95-100A-G2
EMMS-AS-140-...	558170	EAMM-A-S95-140A ²⁾
	3637954	EAMM-A-S95-100A-G2

1) The input torque must not exceed the maximum permissible transferable torque of the axial kit.
 2) Type discontinued

Spindle axes EGC-BS-KF, with recirculating ball bearing guide



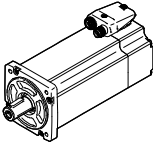
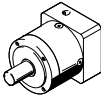
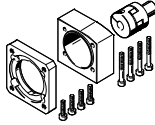

Accessories

Permissible axis/motor combinations with axial kit – with gear unit		Technical data → Internet: eamm-a	
Motor ¹⁾	Gear unit	Axial kit	
			
Type	Type	Part-No.	Type
EGC-70			
With servo motor			
EMME-AS-40-...	EMGA-40-P-G...-EAS-40	1456647	EAMM-A-S38-40G-G2
EMMS-AS-40-...	EMGA-40-P-G...-SAS-40	1456647	EAMM-A-S38-40G-G2
With stepper motor			
EMMS-ST-42-...	EMGA-40-P-G...-SST-42	1456647	EAMM-A-S38-40G-G2
With integrated drive			
EMCA-EC-67-...	EMGC-40-...	1456647	EAMM-A-S38-40G-G2
EGC-80			
With servo motor			
EMME-AS-40-...	EMGA-40-P-G...-EAS-40	1456650	EAMM-A-S48-40G-G2
EMMS-AS-40-...	EMGA-40-P-G...-SAS-40	1456650	EAMM-A-S48-40G-G2
EMMS-AS-55-...	EMGA-60-P-G...-SAS-55	2256701	EAMM-A-S48-60G-G2
EMME-AS-60-...	EMGA-60-P-G...-EAS-60	1456652	EAMM-A-S48-60H-G2
EMMS-AS-70-...	EMGA-60-P-G...-SAS-70	2256701	EAMM-A-S48-60G-G2
With stepper motor			
EMMS-ST-42-...	EMGA-40-P-G...-SST-42	1456650	EAMM-A-S48-40G-G2
EMMS-ST-57-...	EMGA-60-P-G...-SST-57	2256701	EAMM-A-S48-60G-G2
With integrated drive			
EMCA-EC-67-...	EMGC-40-...	1456650	EAMM-A-S48-40G-G2
EMCA-EC-67-...	EMGC-60-...	1456652	EAMM-A-S48-40H-G2
EGC-120			
With servo motor			
EMMS-AS-55-...	EMGA-60-P-G...-SAS-55	2297649	EAMM-A-S62-60G-G2
EMME-AS-60-...	EMGA-60-P-G...-EAS-60	1456654	EAMM-A-S62-60H-G2
EMMS-AS-70-...	EMGA-60-P-G...-SAS-70	2297649	EAMM-A-S62-60G-G2
EMMS-AS-70-...	EMGA-80-P-G...-SAS-70	1972530	EAMM-A-S62-80G-G2
EMME-AS-80-...	EMGA-80-P-G...-EAS-80	1972530	EAMM-A-S62-80G-G2
EMMS-AS-100-...	EMGA-80-P-G...-SAS-100	1972530	EAMM-A-S62-80G-G2
With stepper motor			
EMMS-ST-57-...	EMGA-60-P-G...-SST-57	2297649	EAMM-A-S62-60G-G2
EMMS-ST-87-...	EMGA-80-P-G...-SST-87	1472530	EAMM-A-S62-80G-G2
With integrated drive			
EMCA-EC-67-...	EMGC-60-...	1456654	EAMM-A-S62-60H-G2

1) The input torque must not exceed the maximum permissible transferable torque of the axial kit.

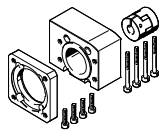
Spindle axes EGC-BS-KF, with recirculating ball bearing guide

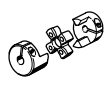
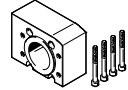



Accessories

Component parts of the axial kit				
Axial kit	Comprises:			
	Motor flange	Coupling	Coupling housing	Screw set
				
Part No. Type	Part No. Type	Part No. Type	Part No. Type	Part No. Type
EGC-70				
558162 EAMM-A-S38-40A	558175 EAMF-A-38B-40A	558312 EAMC-30-32-6-6	558171 EAMK-A-S38-38A/B	–
3637971 EAMM-A-S38-40A-G2	558175 EAMF-A-38B-40A	558312 EAMC-30-32-6-6	3637942 EAMK-A-S38-38A/B-G2	–
1456647 EAMM-A-S38-40G-G2	1460097 EAMF-A-38A-40G	562681 EAMC-30-32-6-10	3637942 EAMK-A-S38-38A/B-G2	567488 EAHM-L2-M5-50
2219044 EAMM-A-S38-40P	2219077 EAMF-A-38B-40P	533708 EAMC-30-32-6-8	558171 EAMK-A-S38-38A/B	–
3637972 EAMM-A-S38-40P-G2	2219077 EAMF-A-38B-40P	533708 EAMC-30-32-6-8	3637942 EAMK-A-S38-38A/B-G2	–
560685 EAMM-A-S38-42A	560691 EAMF-A-38B-42A	561333 EAMC-30-32-5-6	558171 EAMK-A-S38-38A/B	–
3637965 EAMM-A-S38-42A-G2	560691 EAMF-A-38B-42A	561333 EAMC-30-32-5-6	3637942 EAMK-A-S38-38A/B-G2	–
558163 EAMM-A-S38-55A	558176 EAMF-A-38A-55A	551003 EAMC-30-32-6-9	558171 EAMK-A-S38-38A/B	567488 EAHM-L2-M5-50
3637967 EAMM-A-S38-55A-G2	558176 EAMF-A-38A-55A	551003 EAMC-30-32-6-9	3637942 EAMK-A-S38-38A/B-G2	567488 EAHM-L2-M5-50
560686 EAMM-A-S38-57A	560692 EAMF-A-38A-57A	551002 EAMC-30-32-6-6.35	558171 EAMK-A-S38-38A/B	567488 EAHM-L2-M5-50
3637956 EAMM-A-S38-57A-G2	560692 EAMF-A-38A-57A	551002 EAMC-30-32-6-6.35	3637942 EAMK-A-S38-38A/B-G2	567488 EAHM-L2-M5-50
2219110 EAMM-A-S38-60P	1987412 EAMF-A-38B-60P	1233256 EAMC-30-32-6-14	558171 EAMK-A-S38-38A/B	567489 EAHM-L2-M5-55
3637958 EAMM-A-S38-60P-G2	1987412 EAMF-A-38B-60P	1233256 EAMC-30-32-6-14	3637942 EAMK-A-S38-38A/B-G2	567489 EAHM-L2-M5-55
1456638 EAMM-A-S38-67A-G2	1490100 EAMF-A-38A-67A	551003 EAMC-30-32-6-9	3637942 EAMK-A-S38-38A/B-G2	567489 EAHM-L2-M5-55
EGC-80				
1456650 EAMM-A-S48-40G-G2	4067069 EAMF-A-48B-40G	558029 EAMC-30-32-8-10	3637941 EAMK-A-S48-48A/B-G2	–
558164 EAMM-A-S48-55A	558177 EAMF-A-48B-55A	543423 EAMC-30-32-8-9	558172 EAMK-A-S48-48A/B	–
3637961 EAMM-A-S48-55A-G2	558177 EAMF-A-48B-55A	543423 EAMC-30-32-8-9	3637941 EAMK-A-S48-48A/B-G2	–
560687 EAMM-A-S48-57A	560694 EAMF-A-48B-57A	543421 EAMC-30-32-6.35-8	558172 EAMK-A-S48-48A/B	–
3637963 EAMM-A-S48-57A-G2	560694 EAMF-A-48B-57A	543421 EAMC-30-32-6.35-8	3637941 EAMK-A-S48-48A/B-G2	–
2256701 EAMM-A-S48-60G-G2	558019 EAMF-A-48A-60G/H	551004 EAMC-30-32-8-11	3637941 EAMK-A-S48-48A/B-G2	567489 EAHM-L2-M5-55
1456652 EAMM-A-S48-60H-G2	558019 EAMF-A-48A-60G/H	562682 EAMC-30-32-8-14	3637941 EAMK-A-S48-48A/B-G2	567489 EAHM-L2-M5-55
2220560 EAMM-A-S48-60P	2220620 EAMF-A-48A-60P	562682 EAMC-30-32-8-14	558172 EAMK-A-S48-48A/B	567489 EAHM-L2-M5-55
3637964 EAMM-A-S48-60P-G2	2220620 EAMF-A-48A-60P	562682 EAMC-30-32-8-14	3637941 EAMK-A-S48-48A/B-G2	567489 EAHM-L2-M5-55

Spindle axes EGC-BS-KF, with recirculating ball bearing guide

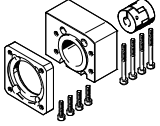
FESTO

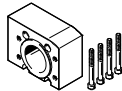
Accessories

Component parts of the axial kit				
Axial kit	Comprises:			
	Motor flange	Coupling	Coupling housing	Screw set
				
Part No. Type	Part No. Type	Part No. Type	Part No. Type	Part No. Type
EGC-80				
558165 EAMM-A-S48-70A	558025 EAMF-A-48A-70A	551004 EAMC-30-32-8-11	558172 EAMK-A-S48-48A/B	567488 EAHM-L2-M5-50
3637957 EAMM-A-S48-70A-G2	558025 EAMF-A-48A-70A	551004 EAMC-30-32-8-11	3637941 EAMK-A-S48-48A/B-G2	567488 EAHM-L2-M5-50
560688 EAMM-A-S48-87A	560695 EAMF-A-48A-87A	551004 EAMC-30-32-8-11	558172 EAMK-A-S48-48A/B	567489 EAHM-L2-M5-55
3637962 EAMM-A-S48-87A-G2	560695 EAMF-A-48A-87A	551004 EAMC-30-32-8-11	3637941 EAMK-A-S48-48A/B-G2	567489 EAHM-L2-M5-55
EGC-120				
2297649 EAMM-A-S62-60G-G2	1460112 EAMF-A-62A-60G/H	525864 EAMC-40-66-11-12	3637940 EAMK-A-S62-62A/B-G2	567495 EAHM-L2-M6-90
1456654 EAMM-A-S62-60H-G2	1460112 EAMF-A-62A-60G/H	1452803 EAMC-40-66-12-14	3637940 EAMK-A-S62-62A/B-G2	567495 EAHM-L2-M6-90
558166 EAMM-A-S62-70A	558179 EAMF-A-62B-70A	558313 EAMC-42-66-11-12	558173 EAMK-A-S62-62A/B	–
3637959 EAMM-A-S62-70A-G2	558179 EAMF-A-62B-70A	558313 EAMC-42-66-11-12	3637940 EAMK-A-S62-62A/B-G2	–
1972530 EAMM-A-S62-80G-G2	2116672 EAMF-A-62B-80G	2138701 EAMC-42-50-12-20	3637940 EAMK-A-S62-62A/B-G2	–
2222582 EAMM-A-S62-80P	2222624 EAMF-A-62B-80P	551005 EAMC-42-50-12-19	558173 EAMK-A-S62-62A/B	–
3637970 EAMM-A-S62-80P-G2	2222624 EAMF-A-62B-80P	551005 EAMC-42-50-12-19	3637940 EAMK-A-S62-62A/B-G2	–
560689 EAMM-A-S62-87A	560696 EAMF-A-62B-87A	558313 EAMC-42-66-11-12	558173 EAMK-A-S62-62A/B	–
3637966 EAMM-A-S62-87A-G2	560696 EAMF-A-62B-87A	558313 EAMC-42-66-11-12	3637940 EAMK-A-S62-62A/B-G2	–
558167 EAMM-A-S62-100A	558026 EAMF-A-62A-100A	551005 EAMC-42-50-12-19	558173 EAMK-A-S62-62A/B	567494 EAHM-L2-M6-80
3637960 EAMM-A-S62-100A-G2	558026 EAMF-A-62A-100A	551005 EAMC-42-50-12-19	3637940 EAMK-A-S62-62A/B-G2	567494 EAHM-L2-M6-80
558168 EAMM-A-S62-140A	558022 EAMF-A-62A-140A	558314 EAMC-42-50-12-24	558173 EAMK-A-S62-62A/B	567495 EAHM-L2-M6-90
3637969 EAMM-A-S62-140A-G2	558022 EAMF-A-62A-140A	558314 EAMC-42-50-12-24	3637940 EAMK-A-S62-62A/B-G2	567495 EAHM-L2-M6-90
EGC-185				
558169 EAMM-A-S95-100A	558182 EAMF-A-95B-100A	558315 EAMC-56-58-19-25	558174 EAMK-A-S95-95A/B	–
3637955 EAMM-A-S95-100A-G2	558182 EAMF-A-95B-100A	558315 EAMC-56-58-19-25	3637939 EAMK-A-S95-95A/B-G2	–
558170 EAMM-A-S95-140A	558023 EAMF-A-95A-140A	558316 EAMC-56-58-24-25	558174 EAMK-A-S95-95A/B	567498 EAHM-L2-M8-100
3637954 EAMM-A-S95-140A-G2	558023 EAMF-A-95A-140A	558316 EAMC-56-58-24-25	3637939 EAMK-A-S95-95A/B-G2	567498 EAHM-L2-M8-100

Spindle axes EGC-BS-KF, with recirculating ball bearing guide

Accessories

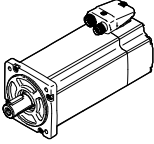
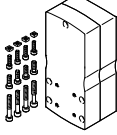
Permissible axis/motor combinations with parallel kit		Technical data → Internet: eamm-u
Motor/gear unit ¹⁾	Parallel kit	
		<ul style="list-style-type: none"> • Increased housing rigidity • More flexible motor mounting possible • Larger toothed belt bending radii for improved service life • Components can be mounted to the kit facing any direction • These parallel kits include a counter bearing EAMG for supporting the axis shaft. Additional information. More information → online eamm-u • Use in combination with third-party motors on request
Type	Part No.	Type
EGC-70-...-BS		
With servo motor		
EMME-AS-40-...	2155239	EAMM-U-50-S38-40P-78
EMMS-AS-40-...	1217708	EAMM-U-50-S38-40A-78
EMMS-AS-55-...	1218538	EAMM-U-60-S38-55A-91
With stepper motor		
EMMS-ST-42-...	1217945	EAMM-U-50-S38-42A-78
EMMS-ST-57-...	1218568	EAMM-U-60-S38-57A-91
With gear unit		
EMGA-40-P-...	2283732	EAMM-U-60-S38-40G-91
EMGC-40-P-...	2283732	EAMM-U-60-S38-40G-91
EGC-80-...-BS		
With servo motor		
EMMS-AS-55-...	1219370	EAMM-U-60-S48-55A-91
EMME-AS-60-...	2629253	EAMM-U-70-S48-60P-96
EMMS-AS-70-...	2787320	EAMM-U-70-S48-70A-96
EMMS-AS-70-...	1217689	EAMM-U-86-S48-70A-102
With stepper motor		
EMMS-ST-57-...	1219379	EAMM-U-60-S48-57A-91
EMMS-ST-87-...	1217604	EAMM-U-86-S48-87A-177
With gear unit		
EMGA-40-P-...	2283760	EAMM-U-60-S48-40G-91
EMGC-40-P-...	2283760	EAMM-U-60-S48-40G-91
EMGA-60-P-...-SAS/SST ²⁾	2801627	EAMM-U-70-S48-60G-96
EMGA-60-P-...-EAS, EMGC-60-P-... ²⁾	2801715	EAMM-U-70-S48-60H-96
EMGA-60-P-...-SAS/SST ²⁾	1587251	EAMM-U-86-S48-60G-102
EMGA-60-P-...-EAS, EMGC-60-P-... ²⁾	1587338	EAMM-U-86-S48-60H-102

1) The input torque must not exceed the maximum permissible transferable torque of the parallel kit.

2) Gear unit drive shaft diameter: EMGA-60-P-...-SAS/SST11 mm; EMGA-60-P-...-EAS, EMGC-60-P14 mm

Spindle axes EGC-BS-KF, with recirculating ball bearing guide

Accessories

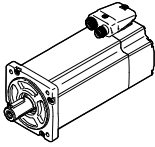
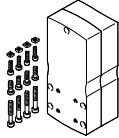
Permissible axis/motor combinations with parallel kit		Technical data → Internet: eamm-u
Motor/gear unit ¹⁾	Parallel kit	
		<ul style="list-style-type: none"> • Increased housing rigidity • More flexible motor mounting possible • Larger toothed belt bending radii for improved service life • Components can be mounted to the kit facing any direction • These parallel kits include a counter bearing EAMG for supporting the axis shaft. Additional information. More information → online eamm-u • Use in combination with third-party motors on request
Type	Part No.	Type
EGC-120-...-BS		
With servo motor		
EMMS-AS-70-...	1217543	EAMM-U-86-S62-70A-177
EMME-AS-80-...	2157004	EAMM-U-86-S62-80P-177
EMME-AS-100-...	1217381	EAMM-U-110-S62-100A-207
EMMS-AS-100-...	1217381	EAMM-U-110-S62-100A-207
EMMS-AS-140-...	1219440	EAMM-U-145-S62-140A-288
With stepper motor		
EMMS-ST-87-...	1217373	EAMM-U-86-S62-87A-177
With gear unit		
EMGA-60-P-...-SAS/SST ²⁾	1587411	EAMM-U-86-S62-60G-177
EMGA-60-P-...-EAS, EMGC-60-P-... ²⁾	1587453	EAMM-U-86-S62-60H-177
EGC-185-...-BS		
With servo motor		
EMME-AS-100-...	1220656	EAMM-U-110-S95-100A-207
EMMS-AS-100-...	1220656	EAMM-U-110-S95-100A-207
EMMS-AS-140-...	1220582	EAMM-U-145-S95-140A-288
With gear unit		
EMGA-80-P-...	1589544	EAMM-U-110-S95-80G-207

1) The input torque must not exceed the maximum permissible transferable torque of the parallel kit.
 2) Gear unit drive shaft diameter: EMGA-60-P-...-SAS/-SST11 mm; EMGA-60-P-...-EAS, EMGC-60-P14 mm

 - Note
 The clamping element EADT is required to adjust the toothed belt pretensioning for EAMM-U-110 and EAMM-U-145.

Spindle axes EGC-BS-KF, with recirculating ball bearing guide

Accessories

Foot mounting HPE
(order code F)

Materials:
Galvanised steel
RoHS-compliant

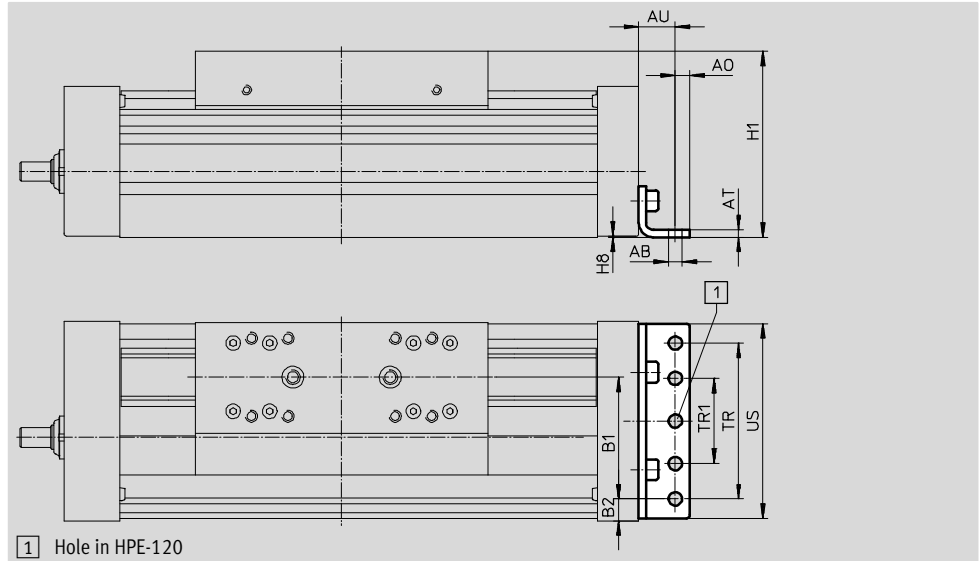

Dimensions and ordering data														
For size	AB ∅	A0	AT	AU	B1	B2	H1	H8	TR	TR1	US	Weight [g]	Part No.	Type
70	5.5	6	3	13	37	14.5	64	0.5	40	-	67	115	558321	HPE-70
80	5.5	6	3	15	38	21	76.5	0.5	40	-	80	150	558322	HPE-80
120	9	8	6	22	65	20	111.5	0.6	80	-	116	578	558323	HPE-120
185	9	12	8	25	118	13	172.5	0.5	160	80	182	1438	558325	HPE-185

Profile mounting MUE
(order code M)

Materials:
Anodised aluminium
RoHS-compliant

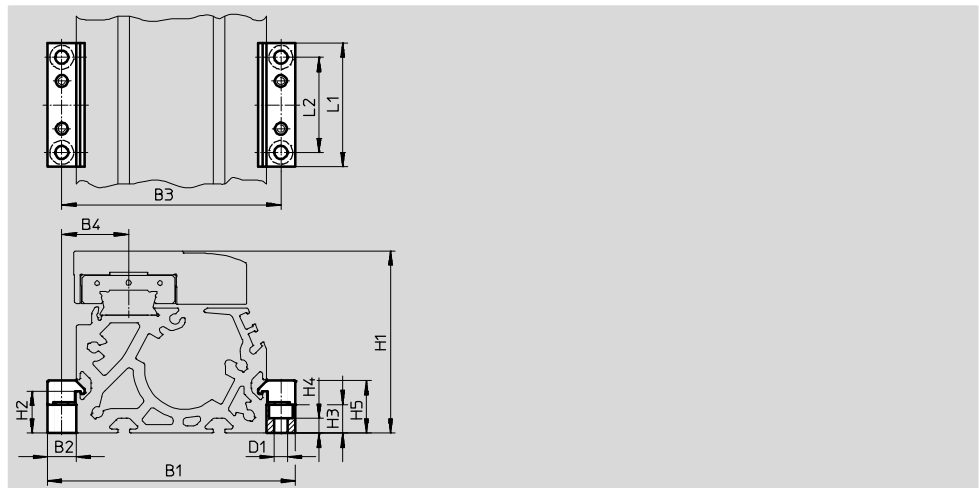

Dimensions and ordering data															
For size	B1	B2	B3	B4	D1 ∅	H1	H2	H3	H4	H5	L1	L2	Weight [g]	Part No.	Type
70	91	12	79	22.5	5.5	64	17.5	12	6.2	22	52	40	80	558043	MUE-70/80
80	104	12	92	28	5.5	76.5	17.5	12	6.2	22	52	40	80	558043	MUE-70/80
120	154	19	135	42.5	9	111.5	16	14	5.5	29.5	90	40	290	558044	MUE-120/185
185	220	19	201	62.5	9	172.5	16	14	5.5	29.5	90	40	290	558044	MUE-120/185

Spindle axes EGC-BS-KF, with recirculating ball bearing guide



Accessories

Central support EAHF

Materials:

Anodised aluminium

RoHS-compliant

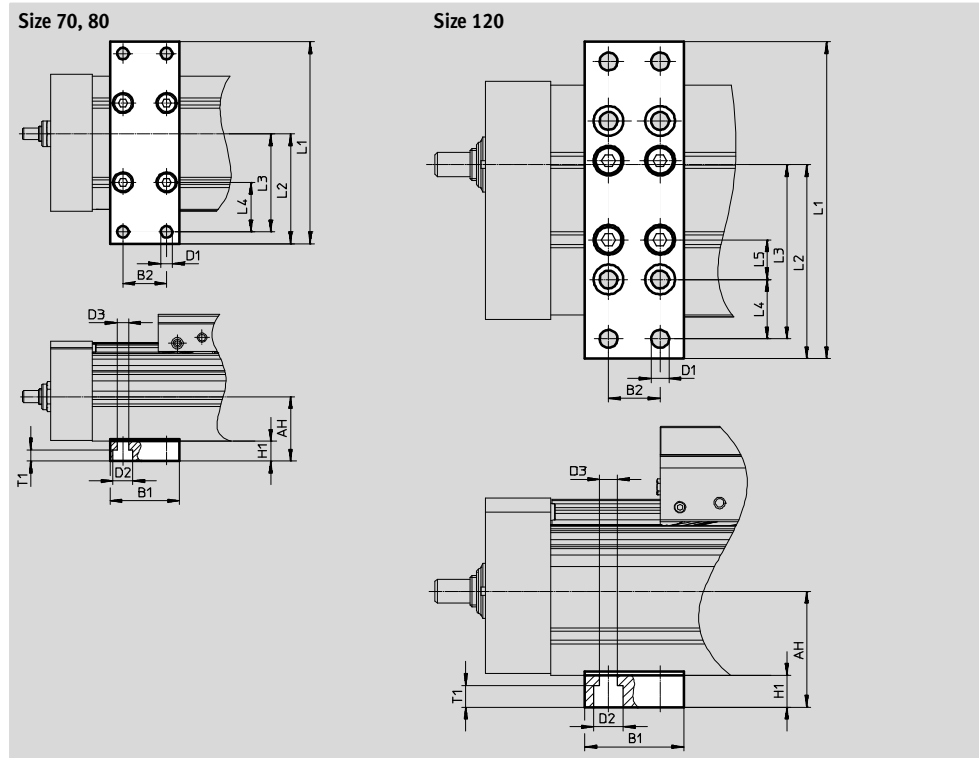

Dimensions and ordering data								
For size	AH	B1	B2	D1 Ø	D2 Ø	D3 Ø	H1	L1
70	32.5	35	22	5.8	10	5.8	10	102
80	37							112
120	58.5	50	26	9	15	9	16	160

For size	L2	L3	L4	L5	T1	Weight [g]	Part No.	Type
70	55.5	49.5	25	-	5.7	113	2349256	EAHF-L5-70-P
80	62	56	30			123	3535188	EAHF-L5-80-P
120	98	88	30	20	11	384	2410274	EAHF-L5-120-P

Spindle axes EGC-BS-KF, with recirculating ball bearing guide

Accessories

Shock absorber retainer KYE
Emergency buffer NPE → 59
(order code A)

Materials:
Anodised aluminium
RoHS-compliant

Cannot be used in combination with
the variants GP and GQ or GK-C, GV-
C and 1H...-PN, 2H-PN.

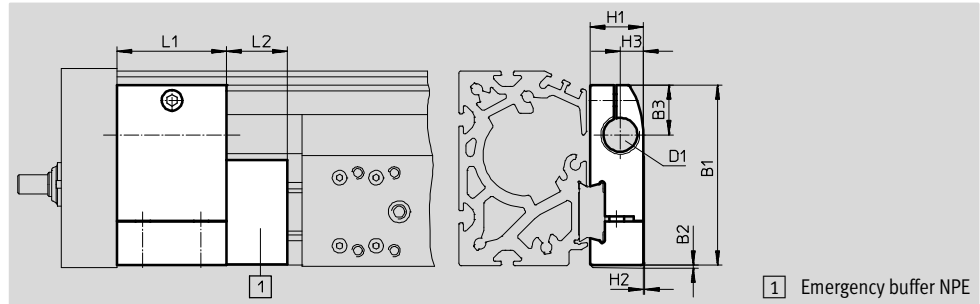

Dimensions and ordering data												
For size	B1	B2	B3	D1	H1	H2	H3	L1	L2	Weight [g]	Part No.	Type
70	57.5	1	16.5	M12x1	18.2	0.5	7.5	30	15	75	557584	KYE-70
80	74.2	1	20.5	M16x1	22	0.5	9.5	45	25	170	557585	KYE-80
120	108.5	1	26	M22x1.5	31	1	14	60	40	680	557586	KYE-120
185	168	1	37	M26x1.5	42	4	18	75	60	1075	557587	KYE-185

Switch lug SF-EGC-1
For sensing via proximity sensor
SIES-8M
(order code X or Z)

Materials:
Galvanised steel
RoHS-compliant

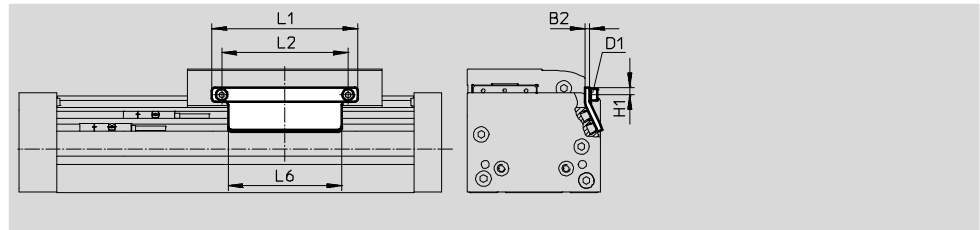

Dimensions and ordering data									
For size	B2	D1	H1	L1	L2	L6	Weight [g]	Part No.	Type
70	3	M4	4.65	70	56	50	50	558047	SF-EGC-1-70
80	3	M4	4.65	90	78	70	63	558048	SF-EGC-1-80
120	3	M5	8	170	140	170	147	558049	SF-EGC-1-120
185	3	M5	10	230	200	230	246	558051	SF-EGC-1-185

Spindle axes EGC-BS-KF, with recirculating ball bearing guide

Accessories



Switch lug SF-EGC-2

For sensing via proximity sensor
SIEN-M8B (order code O, P, W or R) or
SIES-8M (order code X or Z)

Materials:

Galvanised steel
RoHS-compliant

Sensor bracket HWS-EGC

For proximity sensor SIEN-M8B
(order code O, P, W or R)

Materials:

Galvanised steel
RoHS-compliant

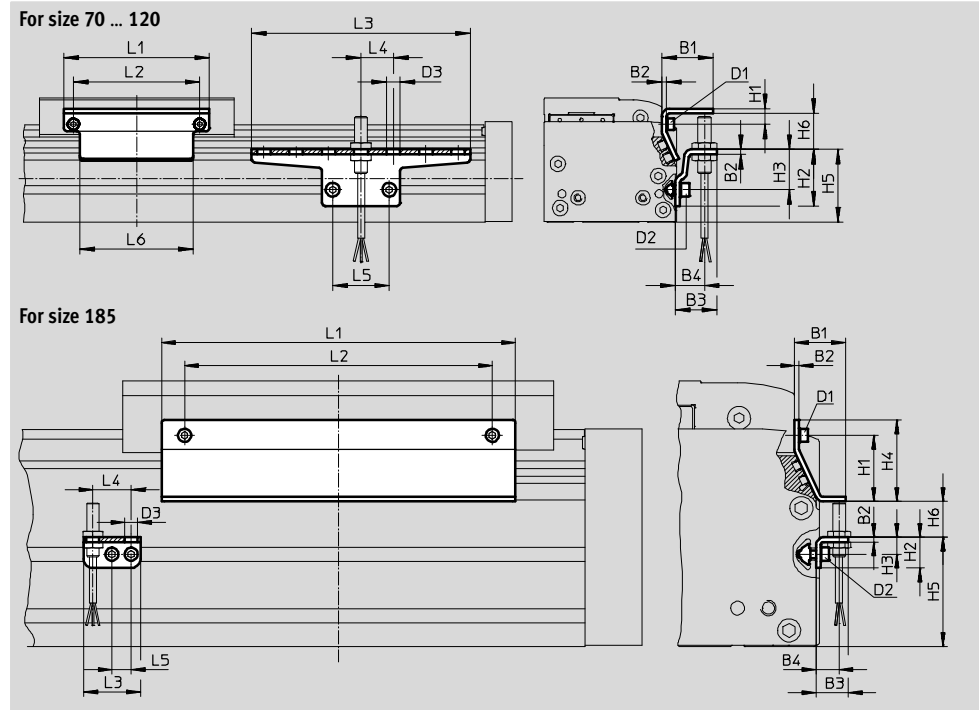
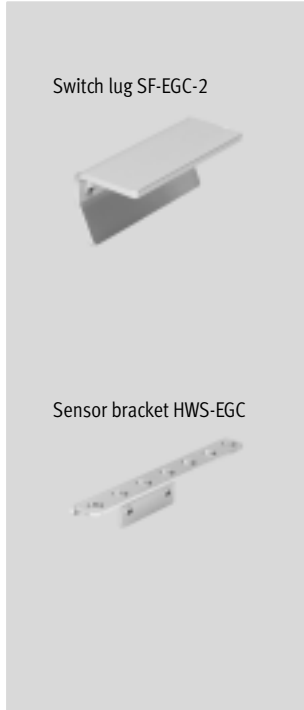

Dimensions and ordering data									
For size	B1	B2	B3	B4	D1	D2	D3	H1	H2
70	31.5	3	25.5	18	M4	M5	8.4	9.5	35
80	31.5	3	25.5	18	M4	M5	8.4	9.5	35
120	32	3	25.5	18	M5	M5	8.4	13.2	65
185	33	3	25.5	15	M5	M5	8.4	43	20





For size	H3	H4	H5	H6 Max.	L1	L2	L3	L4	L5	L6
70	25	-	45	13.5	70	56	135	20	35	50
80	25	-	45	23.5	90	78	135	20	35	70
120	55	-	75	24	170	140	215	20	35	170
185	11	53	71	25.5	230	200	37	25	12.5	230

For size	Weight [g]	Part No.	Type
Switch lug			
70	100	558052	SF-EGC-2-70
80	130	558053	SF-EGC-2-80
120	277	558054	SF-EGC-2-120
185	390	558056	SF-EGC-2-185

For size	Weight [g]	Part No.	Type
Sensor bracket			
70	110	558057	HWS-EGC-M5
80	110	558057	HWS-EGC-M5
120	217	570365	HWS-EGC-M8-B
185	58	560517	HWS-EGC-M8:KURZ

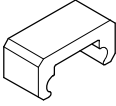
Spindle axes EGC-BS-KF, with recirculating ball bearing guide

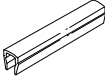
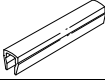
Accessories

Ordering data						
	For size	Comment	Order code	Part No.	Type	PU ¹⁾
Emergency buffer NPE						
	70	For use in combination with shock absorber retainer KYE	A	562581	NPE-70	1
	80			562582	NPE-80	
	120			562583	NPE-120	
	185			562584	NPE-185	
Slot nut NST						
	70, 80	For mounting slot	Y	150914	NST-5-M5	1
				8047843	NST-5-M5-10	10
				8047878	NST-5-M5-50	50
	120, 185	For mounting slot	Y	150915	NST-8-M6	1
				8047868	NST-8-M6-10	10
				8047869	NST-8-M6-50	50
Centring pin/sleeve ZBS/ZBH²⁾						
	70	For slide	-	150928	ZBS-5	10
	80, 120, 185			150927	ZBH-9	
Slot cover ABP						
	70, 80	For mounting slot	B	151681	ABP-5	2
	120, 185	Every 0.5 m		151682	ABP-8	
Slot cover ABP-S						
	70 ... 185	For sensor slot Every 0.5 m	S	563360	ABP-5-S1	2
Clip SMBK						
	70 ... 185	For sensor slot, for attaching the proximity sensor cables	CL	534254	SMBK-8	10

1) Packaging unit quantity

2) 2 centring pins/sleeves included in the scope of delivery of the axis

Spindle axes EGC-BS-KF, with recirculating ball bearing guide

Accessories



Mounting options between axis and support profile

Depending on the adapter kit, the spacing between the axis and the support profile is:
x = 20 mm or 50 mm

The support profile must be mounted using at least 2 adapter kits. For longer strokes, an adapter kit must be used every 500 mm.

Example:

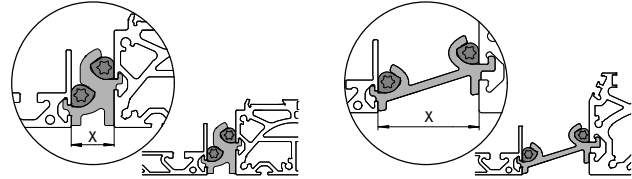





Ordering data					
	For size	Comment	Part No.	Type	PU ¹⁾
Adapter kit DHAM					
	70, 80	<ul style="list-style-type: none"> For mounting the support profile on the axis Spacing between axis and profile is 20 mm 	562241	DHAM-ME-N1-CL	1
	120, 185		562242	DHAM-ME-N2-CL	
	70, 80	<ul style="list-style-type: none"> For mounting the support profile on the axis Spacing between axis and profile is 50 mm 	574560	DHAM-ME-N1-50-CL	
	120, 185		574561	DHAM-ME-N2-50-CL	
Support profile HMIA					
	70 ... 185	<ul style="list-style-type: none"> For guiding an energy chain 	539379	HMIA-E07-	1



1) Packaging unit quantity

Ordering data – Proximity sensors for T-slot, inductive							Technical data → Internet: sies	
	Type of mounting	Electrical connection	Switching output	Cable length [m]	Order code	Part No.	Type	
N/O contact								
	Insertable in the slot from above, flush with the cylinder profile	Cable, 3-wire	PNP	7.5	X	551386	SIES-8M-PS-24V-K-7,5-OE	
		Plug connector M8x1, 3-pin		0.3	-	551387	SIES-8M-PS-24V-K-0,3-M8D	
		Cable, 3-wire	NPN	7.5	-	551396	SIES-8M-NS-24V-K-7,5-OE	
		Plug connector M8x1, 3-pin		0.3	-	551397	SIES-8M-NS-24V-K-0,3-M8D	
N/C contact								
	Insertable in the slot from above, flush with the cylinder profile	Cable, 3-wire	PNP	7.5	Z	551391	SIES-8M-PO-24V-K-7,5-OE	
		Plug connector M8x1, 3-pin		0.3	-	551392	SIES-8M-PO-24V-K-0,3-M8D	
		Cable, 3-wire	NPN	7.5	-	551401	SIES-8M-NO-24V-K-7,5-OE	
		Plug connector M8x1, 3-pin		0.3	-	551402	SIES-8M-NO-24V-K-0,3-M8D	

Spindle axes EGC-BS-KF, with recirculating ball bearing guide

Accessories

Ordering data – Proximity sensor M8 (round design), inductive							Technical data → Internet: sien
	Electrical connection	LED	Switching output	Cable length [m]	Order code	Part No.	Type
N/O contact							
	Cable, 3-wire	■	PNP	2.5	O	150386	SIEN-M8B-PS-K-L
	Plug connector M8x1, 3-pin	■	PNP	–	W	150387	SIEN-M8B-PS-S-L
N/C contact							
	Cable, 3-wire	■	PNP	2.5	P	150390	SIEN-M8B-PO-K-L
	Plug connector M8x1, 3-pin	■	PNP	–	R	150391	SIEN-M8B-PO-S-L

Ordering data – Connecting cables					Technical data → Internet: nebu	
	Electrical connection, left	Electrical connection, right	Cable length [m]	Part No.	Type	
	Straight socket, M8x1, 3-pin	Cable, open end, 3-wire	2.5	159420	SIM-M8-3GD-2,5-PU	
			2.5	541333	NEBU-M8G3-K-2.5-LE3	
			5	541334	NEBU-M8G3-K-5-LE3	
	Angled socket, M8x1, 3-pin	Cable, open end, 3-wire	2.5	541338	NEBU-M8W3-K-2.5-LE3	
			5	541341	NEBU-M8W3-K-5-LE3	

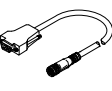
Ordering data – Encoder cables for displacement encoder, EGC-...-M1/-M2					Technical data → Internet: nebm	
	Electrical connection, left	Electrical connection, right	Cable length [m]	Part No.	Type	
	Displacement encoder EGC-...-M1/-M2	Motor controller CMMP-AS-...	5	1599105	NEBM-M12G8-E-5-S1G9-V3	
			10	1599106	NEBM-M12G8-E-10-S1G9-V3	
			15	1599107	NEBM-M12G8-E-15-S1G9-V3	
			χ ¹⁾	1599108	NEBM-M12G8-E-...-S1G9-V3	

1) Max. cable length 25 m.