

Accessories for electrical positioning systems

FESTO



Accessories for electrical positioning systems

Features

FESTO

At a glance

Bellows couplings EAMC-B

→ 3



- One-piece coupling with threaded pin locking, suitable for force-locked and backlash-free transmission of small and medium torques between electric motors and axes.
- System product for positioning technology
- Outside diameter 15 and 19 mm

Gear couplings EAMC

→ 5



- Three-piece coupling with clamping hub, suitable for force-locked and backlash-free transmission of medium and high torques between electric motors and axes.
- System product for positioning technology
- Outside diameter 15, 16, 20, 30, 40, 42, 56, 65, 67 mm

Gear couplings EAMD, with expanding mandrel

→ 10



- Three-piece coupling with expanding mandrel and clamping hub, suitable for force-locked and backlash-free transmission of medium and high torques between electric motors and axes with hollow shafts.
- System product for positioning technology
- Outside diameter 16, 19, 25, 32, 42, 56, 67 mm

Connecting shafts KSK

→ 13



Electric axes are often combined to form multi-axis systems. It is particularly important when designing gantry systems with a medium centre

distance of the axes and heavy loads that the two basic axes be driven synchronously. For these systems, two axes with toothed belt drive are

generally coupled with a shared motor and synchronised using a connecting shaft.

Range of applications:

- For synchronising toothed belt axes DGE and EGC
- For torsion-resistant transmission of the necessary torque
- For slip-free transmission of an identical feed speed
- For compensating tolerances and alignment errors between two axes

Technical data for toothed belt axis:

- DGE-ZR-KF → 14
- EGC-TB-KF → 16
- ELGA-TB-RF → 18
- ELGA-TB-KF → 18

Couplings EAMC

Type codes

Bellows couplings EAMC-B

Type codes

EAMC – B – 19 – 24 – 6 – 9

Type

EAMC	Coupling
------	----------

Coupling type

B	Bellows coupling
---	------------------

Outside diameter [mm]

15	15 mm
----	-------

19	19 mm
----	-------

Overall length

22	22 mm
----	-------

24	24 mm
----	-------

Clamping diameter D1

Clamping diameter D2

Couplings EAMC

Technical data

FESTO

Bellows coupling EAMC-B

∅ - Diameter
15 and 19 mm



General technical data		EAMC-B-15-22	EAMC-B-19-24
Type			
Mass moment of inertia	[kg mm ²]	0.13	0.47
Tightening torque for clamping screw	[Nm]	1.5	1.5
Max. rotational speed	[rpm]	12000	8000
Corrosion resistance class CRC ¹⁾		1	
Materials	Hubs	Aluminium	
	Bellows	Stainless steel	
Note on materials		RoHS-compliant	

1) Corrosion resistance class CRC 1 to Festo standard FN 940070

Low corrosion stress. For dry indoor applications or transport and storage protection. Also applies to parts behind covers, in the non-visible interior area, and parts which are covered in the application (e.g. drive trunnions).

Dimensions and ordering data

Download CAD data → www.festo.com

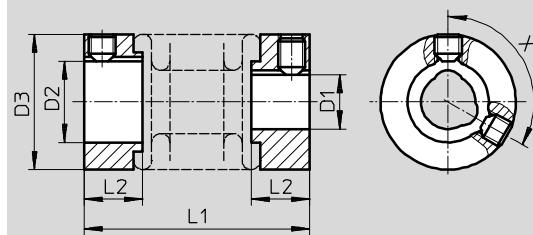

∅ [mm]	D1 ∅ H7	D2 ∅ H7	D3 ∅	L1	L2	X [°]	Transferable torque [Nm]	Weight [g]	Part No.	Type
15	4	5	15	22	6.5	-	1	6	530084	EAMC-B-15-22-4-5
	4	6	15	22	6.5	-	1	6	540750	EAMC-B-15-22-4-6
	4	9	15	22	6.5	-	1	6	184262	EAMC-B-15-22-4-9
	5	5	15	22	6.5	-	1	6	530085	EAMC-B-15-22-5-5
	5	6	15	22	6.5	-	1	6	540751	EAMC-B-15-22-5-6
	5	9	15	22	6.5	-	1	6	529953	EAMC-B-15-22-5-9
19	6	6	19	24	7.5	120	1.5	12	184265	EAMC-B-19-24-6-6
	6	6.35	19	24	7.5	120	1.5	12	530086	EAMC-B-19-24-6-6.35
	6	9	19	24	7.5	120	1.5	12	184263	EAMC-B-19-24-6-9
	6	10	19	24	7.5	120	1.5	12	1450210	EAMC-B-19-24-6-10

Couplings EAMC

Type codes

Gear couplings EAMC

Type codes

EAMC - 42 - 50 - 14 - 20

Type

EAMC	Gear coupling
------	---------------

Outside diameter [mm]

15	15 mm
16	16 mm
20	20 mm
30	30 mm
40	40 mm
42	42 mm
56	56 mm
65	65 mm
67	67 mm

Overall length

20	20 mm
30	30 mm
32	32 mm
35	35 mm
50	50 mm
58	58 mm
62	62 mm
66	66 mm
90	90 mm

Clamping diameter D1

Clamping diameter D2

Couplings EAMC

Technical data

FESTO

Gear coupling EAMC

⌀ Diameter
15 ... 67 mm



General technical data						
Type		EAMC-15-20	EAMC-16-20	EAMC-20-30	EAMC-30-32	EAMC-30-35
Mass moment of inertia	[kg mm ²]	0.23	0.3	1.06	5.87	6.1
Tightening torque for clamping screw	[Nm]	1.3	0.6	0.76	4	2.9
Max. rotational speed	[rpm]	10000	10000	9000	8000	8000
Corrosion resistance class CRC ¹⁾		1				
Materials	Hubs	Aluminium				
	Ring gear	Polyurethane				
Note on materials		RoHS-compliant				

Type		EAMC-40-66	EAMC-42-50	EAMC-42-66	EAMC-56-58	EAMC-65-90	EAMC-67-62
Mass moment of inertia	[kg mm ²]	42.3	35	45.5	128	417	280
Tightening torque for clamping screw	[Nm]	10.5	8	8	15	25	35
Max. speed	[rpm]	6500	6000	6000	5500	4500	4500
Corrosion resistance class CRC ¹⁾		1					
Materials	Hubs	Aluminium					
	Ring gear	Polyurethane					
Note on materials		RoHS-compliant					

1) Corrosion resistance class CRC 1 to Festo standard FN 940070
Low corrosion stress. For dry indoor applications or transport and storage protection. Also applies to parts behind covers, in the non-visible interior area, and parts which are covered in the application (e.g. drive trunnions).

Couplings EAMC

Technical data

FESTO

Dimensions and ordering data

Download CAD data → www.festo.com

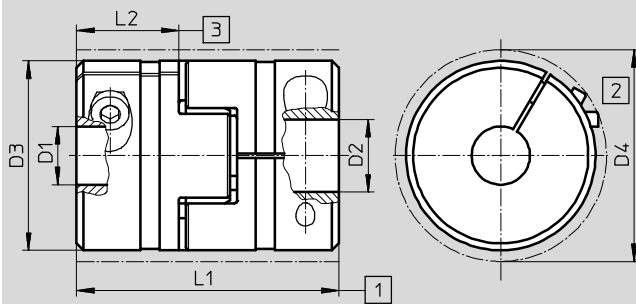

- 1 Nominal length with axial offset compensation
- 2 Min. installation \varnothing (interference profile of clamping screw)
- 3 Insertion depth

\varnothing [mm]	D1 \varnothing H7	D2 \varnothing H7	D3 \varnothing	D4 \varnothing	L1	L2	Transferable torque [Nm]	Weight [g]	Part No.	Type
15	5	6	15	–	20±1	6.5	1.5	8	533707	EAMC-15-20-5-6
16	3	5	16	17	20±1	6	0.2	8	562672	EAMC-16-20-3-5
	3	8	16	17	20±1	6	0.2	8	2310368	EAMC-16-20-3-8
	4	5	16	17	20±1	6	0.65	8	562674	EAMC-16-20-4-5
	4	8	16	17	20±1	6	0.7	8	562675	EAMC-16-20-4-8
	4	6	16	17	20±1	6	0.65	8	562673	EAMC-16-20-4-6
	5	5	16	17	20±1	6	1.1	8	562676	EAMC-16-20-5-5
	5	6	16	17	20±1	6	1.1	8	543419	EAMC-16-20-5-6
	5	8	16	17	20±1	6	1.1	8	562677	EAMC-16-20-5-8
	6	6	16	17	20±1	6	1.6	8	543420	EAMC-16-20-6-6
	6	8	16	17	20±1	6	1.6	8	1232854	EAMC-16-20-6-8
20	5	6	20	24	30	10	2.2	20	558902	EAMC-20-30-5-6
	6	6	20	24	30	10	2.3	20	558901	EAMC-20-30-6-6
	6	10	20	24	30	10	2.3	20	1451964	EAMC-20-30-6-10
30	5	6	30	–	32±1	10.3	3.5	48	561333	EAMC-30-32-5-6
	5	8	30	–	32±1	10.3	3.5	48	562678	EAMC-30-32-5-8
	6	6	30	–	32±1	10.3	6.5	48	558312	EAMC-30-32-6-6
	6	6.35	30	–	32±1	10.3	6.5	48	551002	EAMC-30-32-6-6.35
	6	8	30	–	32±1	10.3	6.5	48	533708	EAMC-30-32-6-8
	6	9	30	–	32±1	10.3	6.5	48	551003	EAMC-30-32-6-9
	6	11	30	–	32±1	10.3	6.5	48	3187577	EAMC-30-32-6-11
	6	14	30	–	32±1	10.3	6.5	48	1233256	EAMC-30-32-6-14
	6.35	8	30	–	32±1	10.3	6.5	48	543421	EAMC-30-32-6.35-8
	6.35	10	30	–	32±1	10.3	6.5	48	562679	EAMC-30-32-6.35-10
	8	8	30	–	32±1	10.3	12.5	48	543422	EAMC-30-32-8-8
	8	9	30	–	32±1	10.3	12.5	48	543423	EAMC-30-32-8-9
	8	10	30	–	32±1	10.3	12.5	48	558029	EAMC-30-32-8-10
	8	11	30	–	32±1	10.3	12.5	48	551004	EAMC-30-32-8-11
	8	14	30	–	32±1	10.3	12.5	48	562682	EAMC-30-32-8-14
	9	10	30	–	32±1	10.3	12.5	48	562680	EAMC-30-32-9-10
	10	10	30	–	32±1	10.3	12.5	48	2310372	EAMC-30-32-10-10
	10	11	30	–	32±1	10.3	12.5	48	565008	EAMC-30-32-10-11
	10	14	30	–	32±1	10.3	12.5	48	562683	EAMC-30-32-10-14

Couplings EAMC

Technical data

FESTO

Dimensions and ordering data

Download CAD data → www.festo.com

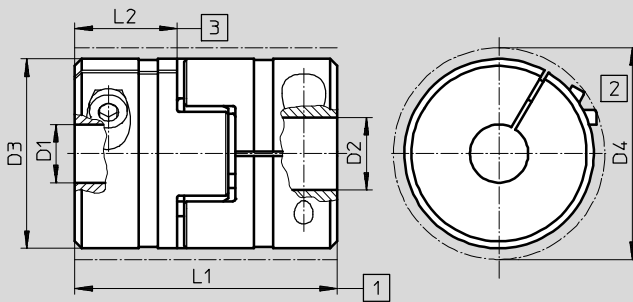

- 1 Nominal length with axial offset compensation
- 2 Min. installation \varnothing (interference profile of clamping screw)
- 3 Insertion depth

\varnothing [mm]	D1 \varnothing H7	D2 \varnothing H7	D3 \varnothing	D4 \varnothing	L1	L2	Transferable torque [Nm]	Weight [g]	Part No.	Type
30	6	6	30	31.4	35±0.7	11	7.5	45	123040	EAMC-30-35-6-6
	6	6.35	30	31.4	35±0.7	11	7.5	45	530087	EAMC-30-35-6-6.35
	6	8	30	31.4	35±0.7	11	7.5	45	123041	EAMC-30-35-6-8
	6	9	30	31.4	35±0.7	11	7.5	45	530941	EAMC-30-35-6-9
	6	10	30	31.4	35±0.7	11	7.5	45	1453062	EAMC-30-35-6-10
	6	11	30	31.4	35±0.7	11	7.5	45	123843	EAMC-30-35-6-11
	6	12	30	31.4	35±0.7	11	7.5	45	123855	EAMC-30-35-6-12
	6.35	8	30	31.4	35±0.7	11	7.5	45	530088	EAMC-30-35-6.35-8
	6.35	12	30	31.4	35±0.7	11	7.5	45	550995	EAMC-30-35-6.35-12
	8	8	30	31.4	35±0.7	11	8	45	123044	EAMC-30-35-8-8
	8	9	30	31.4	35±0.7	11	8	45	557390	EAMC-30-35-8-9
	8	10	30	31.4	35±0.7	11	8	45	123050	EAMC-30-35-8-10
	8	11	30	31.4	35±0.7	11	8	45	123042	EAMC-30-35-8-11
	8	12	30	31.4	35±0.7	11	8	45	123043	EAMC-30-35-8-12
	8	14	30	31.4	35±0.7	11	8	45	1453063	EAMC-30-35-8-14
	9	12	30	31.4	35±0.7	11	8.3	45	550996	EAMC-30-35-9-12
10	12	30	31.4	35±0.7	11	8.6	45	552640	EAMC-30-35-10-12	
11	12	30	31.4	35±0.7	11	8.9	45	123051	EAMC-30-35-11-12	
12	12	30	31.4	35±0.7	11	9.4	45	123052	EAMC-30-35-12-12	
40	9	12	40	45.8	66±0.85	25	17	139	1731999	EAMC-40-66-9-12
	10	12	40	45.8	66±0.85	25	17	139	1452794	EAMC-40-66-10-12
	11	11	40	45.8	66±0.85	25	17	139	530090	EAMC-40-66-11-11
	11	12	40	45.8	66±0.85	25	17	139	525864	EAMC-40-66-11-12
	11	14	40	45.8	66±0.85	25	17	139	1452798	EAMC-40-66-11-14
	11	15	40	45.8	66±0.85	25	17	139	550998	EAMC-40-66-11-15
	11	20	40	45.8	66±0.85	25	17	139	550999	EAMC-40-66-11-20
	12	14	40	45.8	66±0.85	25	17	139	1452803	EAMC-40-66-12-14
	12	15	40	45.8	66±0.85	25	17	139	123850	EAMC-40-66-12-15
	12	19	40	45.8	66±0.85	25	17	139	529952	EAMC-40-66-12-19
	12	20	40	45.8	66±0.85	25	17	139	123851	EAMC-40-66-12-20
	14	20	40	45.8	66±0.85	25	17	139	1452809	EAMC-40-66-14-20
	15	16	40	45.8	66±0.85	25	17	139	123846	EAMC-40-66-15-16
	15	19	40	45.8	66±0.85	25	17	139	123844	EAMC-40-66-15-19
	15	20	40	45.8	66±0.85	25	17	139	123845	EAMC-40-66-15-20
	15	22	40	45.8	66±0.85	25	17	139	3307627	EAMC-40-66-15-22
	15	24	40	45.8	66±0.85	25	17	139	176033	EAMC-40-66-15-24
	19	20	40	45.8	66±0.85	25	17	139	123847	EAMC-40-66-19-20
	20	20	40	45.8	66±0.85	25	17	139	123849	EAMC-40-66-20-20
	20	24	40	45.8	66±0.85	25	17	139	176034	EAMC-40-66-20-24
XX ¹⁾	15	40	45.8	66±0.85	25	-	139	176036	EAMC-40-66-XX-15	
XX ¹⁾	20	40	45.8	66±0.85	25	-	139	176037	EAMC-40-66-XX-20	

1) Hub predrilled to \varnothing 5 mm. Hole max. 20 mm

Couplings EAMC

Technical data

FESTO

Dimensions and ordering data

Download CAD data → www.festo.com

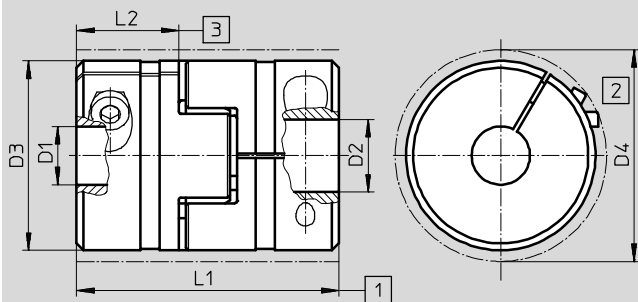

- 1 Nominal length with axial offset compensation
- 2 Min. installation \varnothing (interference profile of clamping screw)
- 3 Insertion depth

\varnothing [mm]	D1 \varnothing H7	D2 \varnothing H7	D3 \varnothing	D4 \varnothing	L1	L2	Transferable torque [Nm]	Weight [g]	Part No.	Type
42	8	19	42	44.5	50±2	17	17	140	2310376	EAMC-42-50-8-19
	9	12	42	44.5	50±2	17	17	138	1732001	EAMC-42-50-9-12
	10	12	42	44.5	50±2	17	17	138	1455666	EAMC-42-50-10-12
	11	12	42	44.5	50±2	17	17	138	543424	EAMC-42-50-11-12
	12	12	42	44.5	50±2	17	17	138	533709	EAMC-42-50-12-12
	12	14	42	44.5	50±2	17	17	138	1455671	EAMC-42-50-12-14
	12	16	42	44.5	50±2	17	17	138	1232880	EAMC-42-50-12-16
	12	19	42	44.5	50±2	17	17	138	551005	EAMC-42-50-12-19
	12	20	42	44.5	50±2	17	17	138	2138701	EAMC-42-50-12-20
	12	24	42	44.5	50±2	17	17	138	558314	EAMC-42-50-12-24
	14	20	42	44.5	50±2	17	17	138	533710	EAMC-42-50-14-20
	11	12	42	44.5	66±2	25	17	166	558313	EAMC-42-66-11-12
56	19	19	56	57	58±2	19.9	60	270	1485673	EAMC-56-58-19-19
	19	20	56	57	58±2	19.9	60	270	3181801	EAMC-56-58-19-20
	19	24	56	57	58±2	19.9	60	270	1485674	EAMC-56-58-19-24
	19	25	56	57	58±2	19.9	60	270	558315	EAMC-56-58-19-25
	24	25	56	57	58±2	19.9	60	270	558316	EAMC-56-58-24-25
65	15	24	65	72.6	90±1.1	35	80	535	530940	EAMC-65-90-15-24
	19	25	65	72.6	90±1.1	35	85	535	551000	EAMC-65-90-19-25
	20	25	65	72.6	90±1.1	35	85	535	176035	EAMC-65-90-20-25
	24	25	65	72.6	90±1.1	35	92	535	123852	EAMC-65-90-24-25
	25	25	65	72.6	90±1.1	35	92	535	123853	EAMC-65-90-25-25
	25	32	65	72.6	90±1.1	35	92	535	1745817	EAMC-65-90-25-32
	25	40	65	72.6	90±1.1	35	62	535	551001	EAMC-65-90-25-40
	XX ²⁾	25	65	72.6	90±1.1	35	-	535	176038	EAMC-65-90-XX-25
67	24	24	66.5	68	62±2	21	143	430	1451407	EAMC-67-62-24-24
	24	25	66.5	68	62±2	21	143	430	3187895	EAMC-67-62-24-25
	24	32	66.5	68	62±2	21	143	430	1485796	EAMC-67-62-24-32

2) Hub predrilled to \varnothing 9.5 mm. Hole max. 38 mm

Couplings EAMD

Type codes

Gear couplings EAMD, with expanding mandrel

Type codes

EAMD - 25 - 22 - 6.35 - 10 X 12 - U

Type	
EAMD	Gear coupling with expanding mandrel

Outside diameter [mm]	
16	16 mm
19	19 mm
25	25 mm
28	28 mm
32	32 mm
42	42 mm
56	56 mm
67	67 mm

Overall length	
15	15 mm
22	22 mm
32	32 mm
40	40 mm
46	46 mm
51	51 mm
82	82 mm

Clamping diameter D1

Mandrel diameter D2

Mandrel length C2

Ring gear hardness U

Couplings EAMD

Technical data

Gear coupling EAMD, with expanding mandrel

 Diameter
 16 ... 67 mm



General technical data		EAMD-16-15	EAMD-19-15	EAMD-25-22	EAMD-28-22
Type					
Mass moment of inertia	[kg mm ²]	0.355	0.445	3.2	3.3
Tightening torque for clamping screw D1	[Nm]	0.6	0.6	2	2
Tightening torque for clamping screw D2	[Nm]	1	1	1.5	1.5
Max. rotational speed	[rpm]	10000	10000	8000	8000
Corrosion resistance class CRC ¹⁾		1			
Materials	Hubs	Aluminium			
	Ring gear	Polyurethane			
Note on materials		RoHS-compliant			

Type		EAMD-32-32	EAMD-42-40	EAMD-56-46	EAMD-67-51	EAMD-67-82
Mass moment of inertia	[kg mm ²]	14.5	39	147	374	831
Tightening torque for clamping screw D1	[Nm]	4	8	15	35	35
Tightening torque for clamping screw D2	[Nm]	7	8.5	14	60	60
Max. speed	[rpm]	8000	6000	5500	4500	4500
Corrosion resistance class CRC ¹⁾		1				
Materials	Hubs	Aluminium				
	Ring gear	Polyurethane				
Note on materials		RoHS-compliant				

1) Corrosion resistance class CRC 1 to Festo standard FN 940070
 Low corrosion stress. For dry indoor applications or transport and storage protection. Also applies to parts behind covers, in the non-visible interior area, and parts which are covered in the application (e.g. drive trunnions).

Couplings EAMD

Technical data

FESTO

Dimensions and ordering data Download CAD data → www.festo.com

EAMD-16-.../EAMD-19-... EAMD-...

1 Nominal length with axial offset compensation
 2 Min. installation \varnothing (interference profile of clamping screw)
 3 Insertion depth

\varnothing [mm]	D1 \varnothing H7	D2 \varnothing H7	D3 \varnothing	D4 \varnothing	D5 \varnothing	L1	L2	L3	L4	Transferable torque [Nm]	Weight [g]	Part No.	Type
16	6.35	8	16	16	-	15±1	10	6	-	1.6	13	561292	EAMD-16-15-6.35-8X10
	8	8	16	16	-	15±1	10	6	-	2	13	1184697	EAMD-16-15-8-8X10
19	9	8	19	16	-	15±1	10	6	-	2	13	557999	EAMD-19-15-9-8X10
	10	8	19	16	-	15±1	10	6	-	2	13	557998	EAMD-19-15-10-8X10
25	6.35	10	25	22	-	22+1	12	8.1	1	3.6	44	561293	EAMD-25-22-6.35-10X12
	10	10	25	22	-	22+1	12	8.1	1	9	44	1453860	EAMD-25-22-10-10X12
	11	10	25	22	-	22+1	12	8.1	1	9	44	558000	EAMD-25-22-11-10X12
28	14	10	28	22	-	22±1	12	8	1	9	49	1453861	EAMD-28-22-14-10X12
32	11	16	32	25	-	32±1	20	10.1	1.5	12.5	126	558001	EAMD-32-32-11-16X20
	14	16	32	25	-	32±1	20	10.1	1.5	12.5	126	1377840	EAMD-32-32-14-16X20
	16	16	32	25	-	32±1	20	10.1	1.5	12.5	126	1184858	EAMD-32-32-16-16X20
42	14	16	42	25	44.5	40±2	25	17	1.5	21	190	3420022	EAMD-42-40-14-16X25-U
	19	16	42	25	44.5	40±2	25	17	1.5	17	190	558002	EAMD-42-40-19-16X25
	20	16	42	25	44.5	40±2	25	17	1.5	17	190	1188350	EAMD-42-40-20-16X25
	20	16	42	25	44.5	40±2	25	17	1.5	21	190	1781043	EAMD-42-40-20-16X25-U
56	19	23	56	40	57	46.5±2	27	20	2	60	392	558003	EAMD-56-46-19-23X27
	20	23	56	40	57	46.5±2	27	20	2	60	392	558004	EAMD-56-46-20-23X27
	24	23	56	40	57	46.5±2	27	20	2	60	392	558005	EAMD-56-46-24-23X27
	25	23	56	40	57	46.5±2	27	20	2	60	392	1188801	EAMD-56-46-25-23X27
	25	23	56	40	57	46.5±2	27	20	2	75	392	1781045	EAMD-56-46-25-23X27-U
67	19	32	66.5	-	68	51±2	32	21	-	113	735	3398671	EAMD-67-51-19-32X32-U
	20	32	66.5	-	68	51±2	32	21	-	120	735	3717812	EAMD-67-51-20-32X32-U
	24	32	66.5	-	68	51±2	32	21	-	143	735	558008	EAMD-67-51-24-32X32-U
	25	32	66.5	-	68	51±2	32	21	-	150	735	558006	EAMD-67-51-25-32X32-U
	32	32	66.5	-	68	51±2	32	21	-	192	735	1379269	EAMD-67-51-32-32X32-U
	32	32	66.5	-	68	82±2	32	21	-	192	1560	1379270	EAMD-67-82-32-32X32-U

Connecting shaft KSK

Type codes

For toothed belt axis DGE-...-ZR-KF

		KSK	25	800
Type				
KSK	Connecting shaft			
Size				
25	DGE-25-...-ZR-KF			
40	DGE-40-...-ZR-KF			
63	DGE-63-...-ZR-KF			
Nominal length L1				

For toothed belt axis EGC-...-TB-KF

		KSK	80	800
Type				
KSK	Connecting shaft			
Size				
50	EGC-50-...-TB-KF			
70	EGC-70-...-TB-KF			
80	EGC-80-...-TB-KF			
120	EGC-120-...-TB-KF			
185	EGC-185-...-TB-KF			
Nominal length L1				

For toothed belt axis ELGA-TB-RF-.../ELGA-TB-KF-...

		KSK	80	1000
Type				
KSK	Connecting shaft			
Size				
A-70	ELGA-TB-RF-70-...			
	ELGA-TB-KF-70-...			
80	ELGA-TB-RF-80-...			
	ELGA-TB-KF-80-...			
120	ELGA-TB-RF-120-...			
	ELGA-TB-KF-120-...			
185	ELGA-TB-KF-150-...			
Nominal length L1				

Connecting shaft KSK

Technical data

FESTO

Connecting shafts KSK
for toothed belt axis DGE-ZR-KF

Ø - Size
25, 40, 63

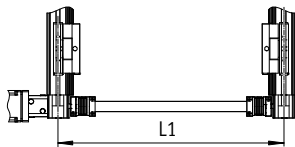

Nominal length L1 = Centre-to-centre distance between the axes

The total mass is calculated as follows:

$$m_{\text{total}} = m_0 + m_L \times L1$$

The moment of inertia is calculated as follows:

$$J_{\text{total}} = J_0 + J_L \times L1$$

General technical data			
Size	25	40	63
Design	Connecting tube with a coupling at each end		
Mounting position	Horizontal (vertical on request)		
Nominal length L1 [mm]	200 ... 2000	250 ... 2000	350 ... 2000
Basic moment of inertia J_0 with L1 = 0mm [kg mm ²]	31	147	1310
Additional moment of inertia J_L per 1m nominal length [kg mm ² /m]	34	80	333
Max. permissible axial offset [mm]	±2		
Basic weight m_0 with L1 = 0mm [kg]	0.22	0.36	1.8
Additional weight m_L per 1m nominal length [kg/m]	0.32	0.48	0.8

Operating and environmental conditions	
Ambient temperature [°C]	-10 ... +60
Corrosion resistance class CRC ¹⁾	2
Materials	
Coupling, Hubs	Wrought aluminium alloy
Coupling, Bellows	High-alloy steel
Connecting tube, drive shaft materials	High-alloy steel
Note on materials	RoHS-compliant
	Contains PWIS (paint-wetting impairment substances)

1) Corrosion resistance class CRC 2 to Festo standard FN 940070

Moderate corrosion stress. Indoor applications in which condensation may occur. External visible parts with primarily decorative requirements for the surface and which are in direct contact with the ambient atmosphere typical for industrial applications.

Max. rotational speed n as a function of nominal length L1

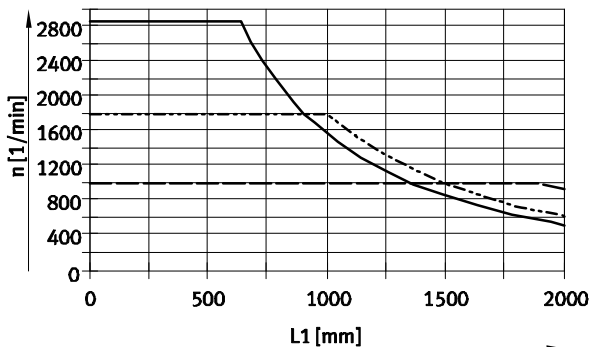

Max. speed v as a function of nominal length L1

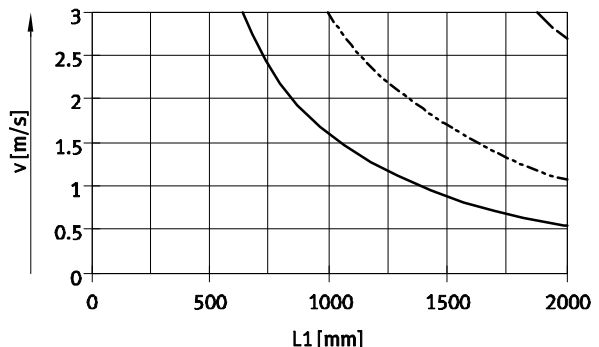

— KSK-25
- - - KSK-40
- · - KSK-63

Connecting shaft KSK

Technical data

FESTO

Dimensions and ordering data

Download CAD data → www.festo.com

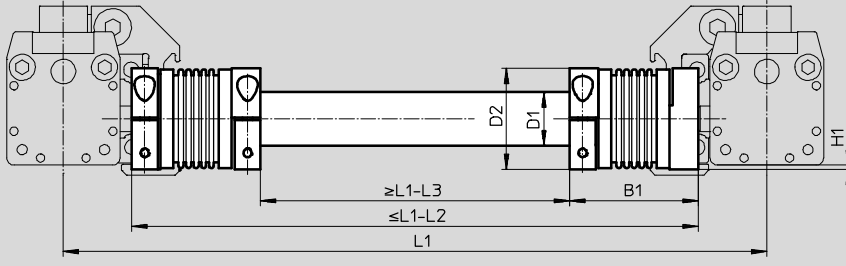

Size [mm]	B1	D1 ∅	D2 ∅	H1	L1	L2	L3	Part No.	Type
25	50	21.27	40	1.6	1)	51.4	156.4	196587	KSK-25-...
40	59	26.52	49	–		71.4	194.6	196588	KSK-40-...
63	94	41.6	81	–		114.6	308.6	196589	KSK-63-...

1) Centre-to-centre distance between the axes

Note

The nominal length L1 must be specified in the type code when ordering. The nominal length L1 indicates the centre-to-centre distance between the axes in this case.

Order example:
Two toothed belt axes
DGE-40-...-ZR-KF are to be linked using a connecting shaft with a nominal length L1 = 1000 mm.

The following connecting shaft is required:
Type: KSK-40-1000
Part No. 196 588

Connecting shaft KSK

Technical data

FESTO

Connecting shafts KSK
for toothed belt axis EGC-TB-KF

Ø - Size
50, 70, 80, 120, 185

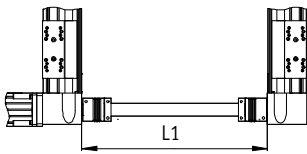

Nominal length L1 = Inside width
between the drive covers

The total mass is calculated as
follows:

$$m_{\text{total}} = m_0 + m_L \times L1$$

The moment of inertia is calculated as
follows:

$$J_{\text{total}} = J_0 + J_L \times L1$$

General technical data

Size	50	70	80	120	185
Design	Connecting tube with a coupling at each end as well as 2 drive shafts for adapting the hollow shaft				
Mounting position	Horizontal (vertical on request)				
Nominal length L1 [mm]	200 ... 2000			250 ... 2000	350 ... 2000
Basic moment of inertia J_0 with L1 = 0mm [kg mm ²]	34	35	159	1390	7261
Additional moment of inertia J_L per 1m nominal length [kg mm ² /m]	34	34	80	333	1946
Max. permissible axial offset [mm]	±2				±5
Basic weight m_0 with L1 = 0mm [kg]	0.28	0.29	0.53	2.28	5.29
Additional weight m_L per 1m nominal length [kg/m]	0.32	0.32	0.48	0.8	1.89

Operating and environmental conditions

Ambient temperature [°C]	-10 ... +60
Corrosion resistance class CRC ¹⁾	2
Materials	
Coupling, Hubs	Wrought aluminium alloy
Coupling, Bellows	High-alloy steel
Connecting tube, drive shaft materials	High-alloy steel
Note on materials	
	RoHS-compliant
	Contains PWIS (paint-wetting impairment substances)

1) Corrosion resistance class CRC 2 to Festo standard FN 940070

Moderate corrosion stress. Indoor applications in which condensation may occur. External visible parts with primarily decorative requirements for the surface and which are in direct contact with the ambient atmosphere typical for industrial applications.

Max. rotational speed n as a function of nominal length L1

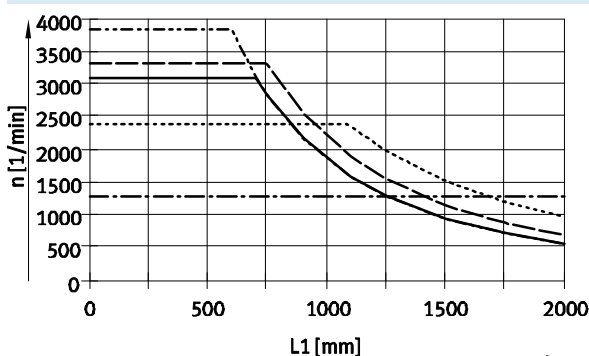

— KSK-50 ····· KSK-120
- - - KSK-70 - · - KSK-185
- · - KSK-80

Max. speed v as a function of nominal length L1

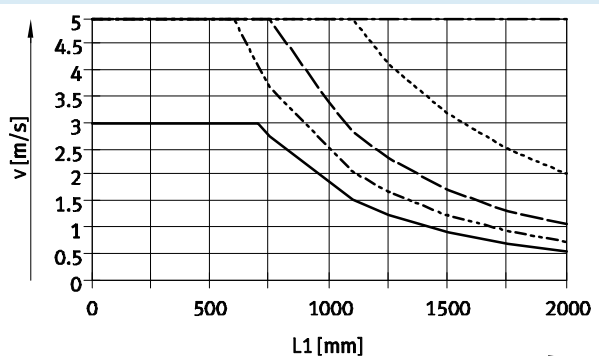

Connecting shaft KSK

Technical data

FESTO

Dimensions and ordering data

Download CAD data → www.festo.com

Internal/external guide

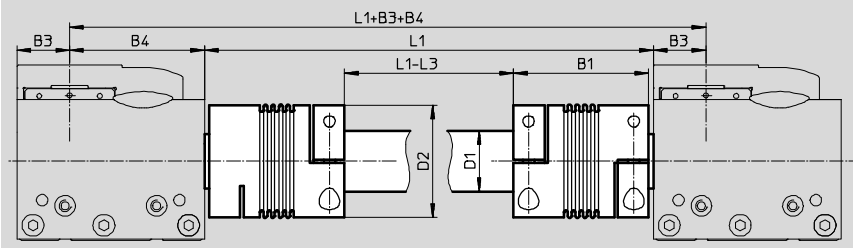

Internal guide

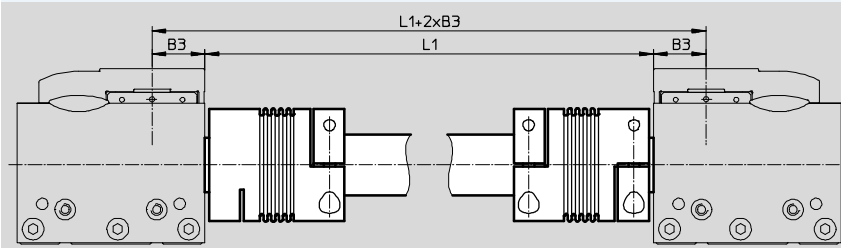

External guide

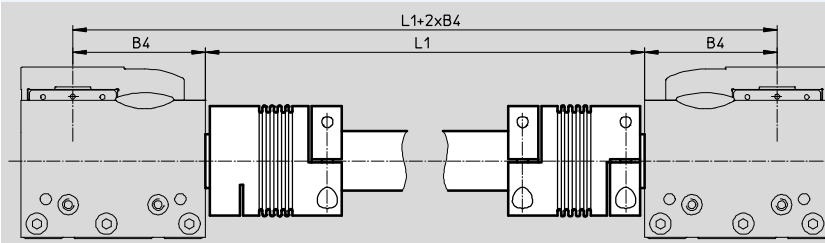

Projection of coupling

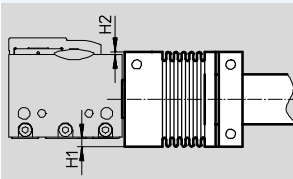

Size [mm]	B1	B3	B4	D1 ∅	D2 ∅	H1	H2	L1	L3	Part No.	Type
50	50	12.5	35.5	21.27	40	4	1	1)	102.2	563710	KSK-50-...
70	50	17.5	51.5	21.27	40	-	-		103.7	562520	KSK-70-...
80	59	23	59	26.52	49	-	-		122	562521	KSK-80-...
120	94	35	85	41.6	81	-	1		192	562522	KSK-120-...
185	111	55	131	65.4	110	-	-		228	562523	KSK-185-...

1) Inside width between the drive covers

Note

The nominal length L1 must be specified in the type code when ordering. The nominal length L1 indicates the inside width between the drive covers in this case.

Order example:
Two toothed belt axes EGC-70-...-TB-KF are to be linked using a connecting shaft with a nominal length L1 = 1000 mm.

The following connecting shaft is required:
Type: KSK-70-1000
Part No. 562 520

Connecting shaft KSK

Technical data

FESTO

Connecting shafts KSK
for toothed belt axis ELGA-TB-RF

⌀ - Size
A-70, 80, 120

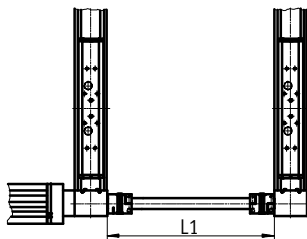

Nominal length L1 = Inside width
between the drive covers

The total mass is calculated as
follows:

$$m_{\text{total}} = m_0 + m_L \times L1$$

The moment of inertia is calculated as
follows:

$$J_{\text{total}} = J_0 + J_L \times L1$$

General technical data			
Size	A-70	80	120
Design	Connecting tube with a coupling at each end as well as 2 drive shafts for adapting the hollow shaft. 2 plugs are supplied additionally with the KSK-185 for insertion into the pipe ends		
Mounting position	Horizontal (vertical on request)		
Nominal length L1 [mm]	200 ... 2000		250 ... 2000
Basic moment of inertia J_0 [kg mm ²] with L1 = 0mm	161	159	1390
Additional moment of inertia J_L [kg mm ² /m] per 1m nominal length	80	80	333
Max. permissible axial offset [mm]	±2		
Basic weight m_0 [kg] with L1 = 0mm	0.54	0.53	2.28
Additional weight m_L [kg/m] per 1m nominal length	0.48	0.48	0.8

Operating and environmental conditions	
Ambient temperature [°C]	-10 ... +60
Corrosion resistance class CRC ¹⁾	2
Materials	
Coupling, Hubs	Wrought aluminium alloy
Coupling, Bellows	High-alloy steel
Connecting tube, drive shaft materials	High-alloy steel
Note on materials	
	RoHS-compliant
	Contains PWIS (paint-wetting impairment substances)

1) Corrosion resistance class CRC 2 to Festo standard FN 940070

Moderate corrosion stress. Indoor applications in which condensation may occur. External visible parts with primarily decorative requirements for the surface and which are in direct contact with the ambient atmosphere typical for industrial applications.

Max. rotational speed n as a function of nominal length L1

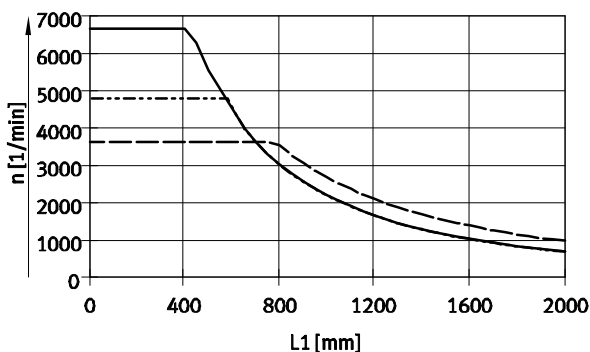

Max. speed v as a function of nominal length L1

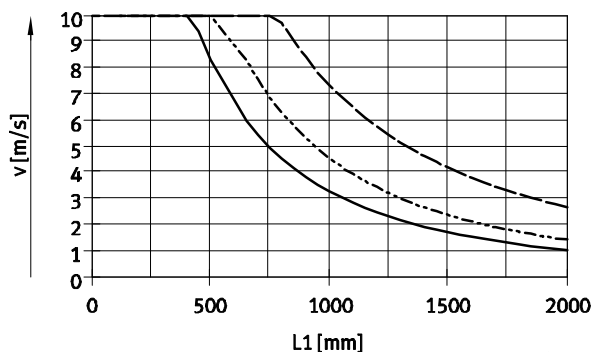

— KSK-A-70
- - - KSK-80
- · - KSK-120

Connecting shaft KSK

Technical data

FESTO

Dimensions and ordering data

Download CAD data → www.festo.com

Internal/external guide

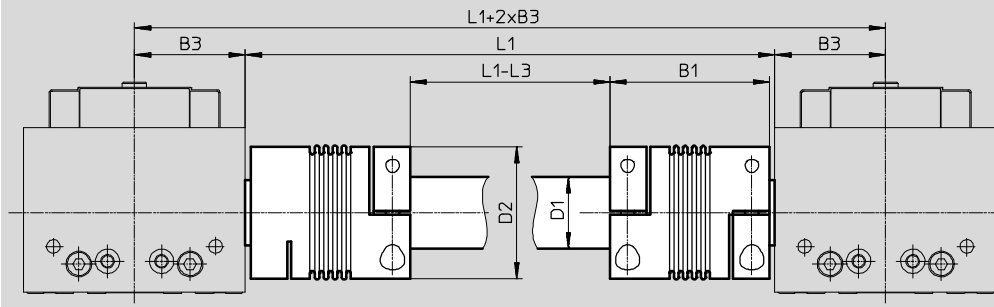

Projection of coupling

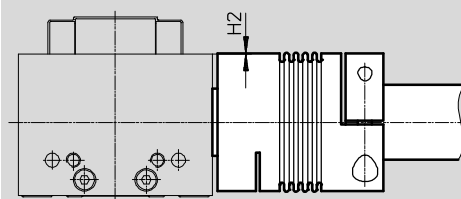

Size	B1	B3	D1	D2	H2	L1	L3	Part No.	Type
[mm]			∅ H7	∅					
70	59	34.5	26.52	49	0.2	1)	122	2261462	KSK-A-70-...
80	59	34.5	26.52	49	-		122	562521	KSK-80-...
120	94	60	41.6	81	-		192	562522	KSK-120-...

1) Inside width between the drive covers

Note

The nominal length L1 must be specified in the type code when ordering. The nominal length L1 indicates the inside width between the drive covers in this case.

Order example:
Two toothed belt axes
ELGA-TB-RF-80-... are to be linked
using a connecting shaft with a
nominal length L1 = 1000 mm.

The following connecting shaft is
required:
Type: KSK-80-1000
Part No. 562521

Connecting shaft KSK

Technical data

FESTO

Connecting shafts KSK
for toothed belt axis ELGA-TB-KF

Ø - Size
A-70, 80, 120, 185

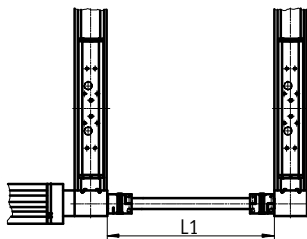

Nominal length L1 = Inside width
between the drive covers

The total mass is calculated as
follows:

$$m_{\text{total}} = m_0 + m_L \times L1$$

The moment of inertia is calculated as
follows:

$$J_{\text{total}} = J_0 + J_L \times L1$$

General technical data				
Size	A-70	80	120	185
Design	Connecting tube with a coupling at each end as well as 2 drive shafts for adapting the hollow shaft. 2 plugs are supplied additionally with the KSK-185 for insertion into the pipe ends			
Mounting position	Horizontal (vertical on request)			
Nominal length L1 [mm]	200 ... 2000		250 ... 2000	350 ... 2000
Basic moment of inertia J ₀ [kg mm ²] with L1 = 0mm	161	159	1390	7261
Additional moment of inertia J _L [kg mm ² /m] per 1m nominal length	80	80	333	1946
Max. permissible axial offset [mm]	±2			±5
Basic weight m ₀ [kg] with L1 = 0mm	0.54	0.53	2.28	5.29
Additional weight m _L [kg/m] per 1m nominal length	0.48	0.48	0.8	1.89

Operating and environmental conditions	
Ambient temperature [°C]	-10 ... +60
Corrosion resistance class CRC ¹⁾	2
Materials	
Coupling, Hubs	Wrought aluminium alloy
Coupling, Bellows	High-alloy steel
Connecting tube, drive shaft materials	High-alloy steel
Note on materials	
	RoHS-compliant
	Contains PWIS (paint-wetting impairment substances)

1) Corrosion resistance class CRC 2 to Festo standard FN 940070

Moderate corrosion stress. Indoor applications in which condensation may occur. External visible parts with primarily decorative requirements for the surface and which are in direct contact with the ambient atmosphere typical for industrial applications.

Max. rotational speed n as a function of nominal length L1

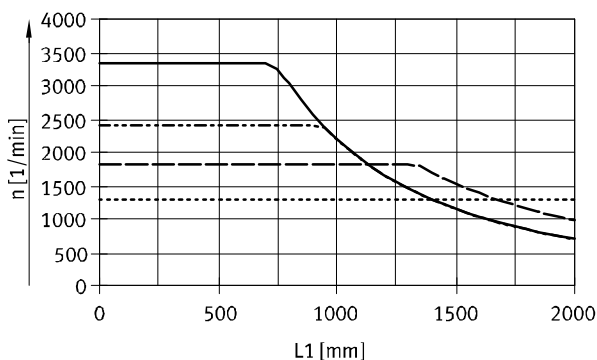

Max. speed v as a function of nominal length L1

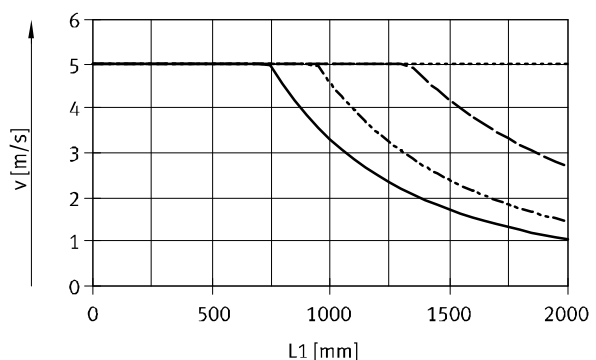

— KSK-A-70 - - - KSK-120
- - - - KSK-80 ····· KSK-185

Connecting shaft KSK

Technical data

FESTO

Dimensions and ordering data

Download CAD data → www.festo.com

Internal/external guide

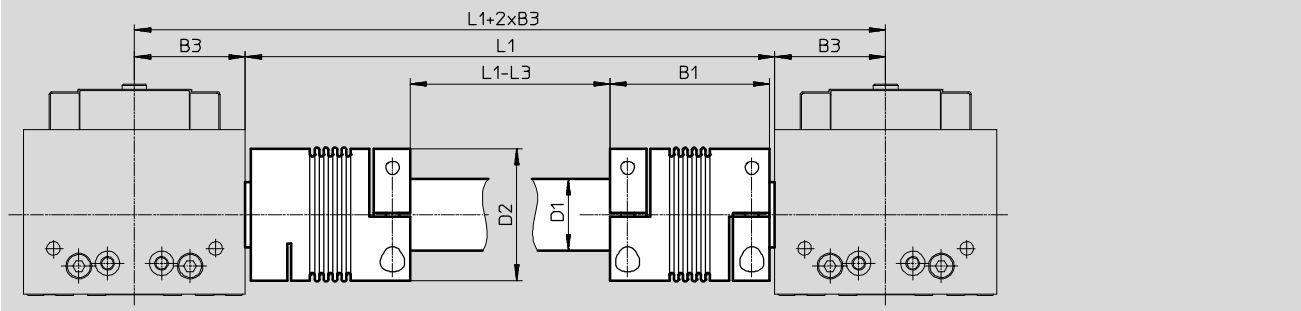

Projection of coupling

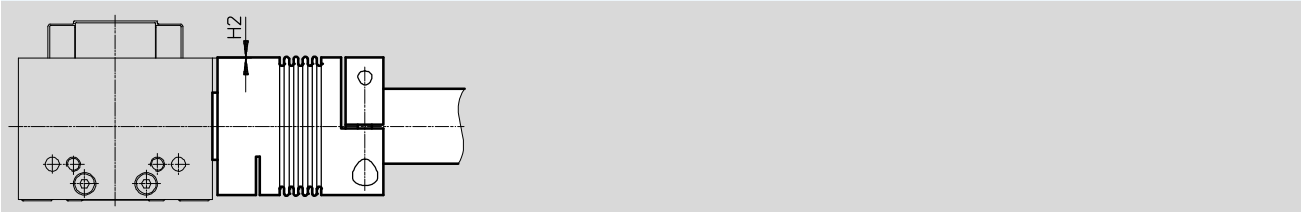

Size	B1	B3	D1	D2	H2	L1	L3	Part No.	Type
[mm]			∅ H7	∅					
70	59	34.5	26.52	49	0.2	1)	122	2261462	KSK-A-70-...
80	59	41	26.52	49	-		122	562521	KSK-80-...
120	94	60	41.6	81	-		192	562522	KSK-120-...
185	111	77	65,4	110	-		228	562253	KSK-185-...

1) Inside width between the drive covers

Note

The nominal length L1 must be specified in the type code when ordering. The nominal length L1 indicates the inside width between the drive covers in this case.

Order example:
Two toothed belt axes
ELGA-TB-KF-80-... are to be linked
using a connecting shaft with a
nominal length L1 = 1000 mm.

The following connecting shaft is
required:
Type: KSK-80-1000
Part No. 562521