

Parallel grippers DHPS



Parallel grippers DHPS

Key features

FESTO

At a glance

General information

- Resilient and precise T-slot guide of the gripper jaws
- Oval piston for high gripping forces
- High gripping forces with compact dimensions
- Gripper jaw centring options
- Max. repetition accuracy
- Gripping force retention
- Internal fixed flow control
- Wide range of options for mounting on drive units

- Sensor technology:
 - Adaptable position sensor for the small grippers
 - Integratable proximity sensors for the medium and large grippers

Flexible range of applications

- Can be used as a double-acting and single-acting gripper
- Compression spring for supplementary or retaining gripping forces
- Suitable for external and internal gripping

The technology in detail

Gripper closed

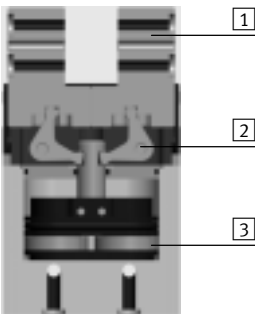

Gripper open

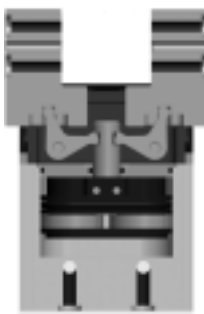

- 1 Gripper jaw
- 2 Reversing lever
- 3 Piston with magnet

-  - Note
 Gripper selection
 sizing software
 → www.festo.com

Position sensing/force control

With position transmitter SMAT-8M, SDAT



- Analogue positional feedback possible
- Analogue output
 - 0 ... 10 V
 - 4 ... 20 mA

With proportional pressure regulator VPPM



- Infinite adjustment of the gripping force possible
- Setpoint input
 - 0 ... 10 V
 - 4 ... 20 mA

With proximity sensor SMT-8G/-10G



- Multiple positions can be sensed:
- Open
 - Closed
 - Workpiece gripped

Parallel grippers DHPS

Key features

Supply ports

At the side

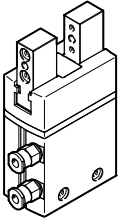

Mounting options

At the side

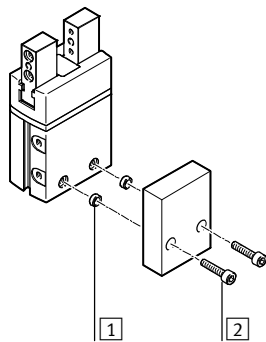
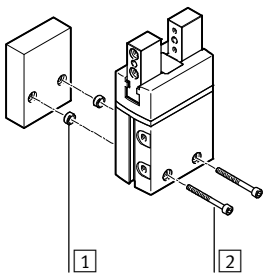

From underneath

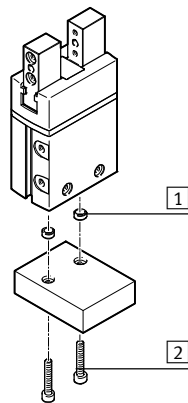

- 1 Centring sleeves
- 2 Mounting screws

Mounting options for external gripper fingers

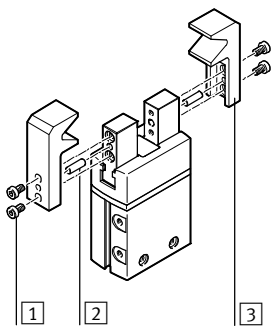

- 1 Mounting screws
- 2 Centring pins
- 3 Gripper fingers

Note

These grippers are not designed for the following or similar sample applications:

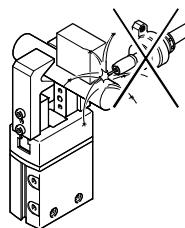

• Welding spatter

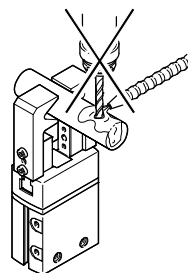

• Machining
• Aggressive media

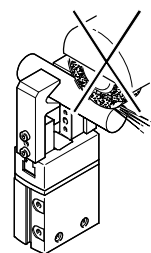

• Grinding dust

Parallel grippers DHPS

Peripherals overview

Peripherals overview

DHPS-06

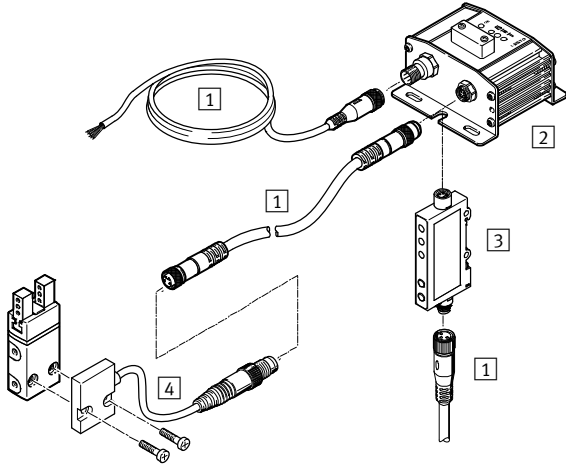

DHPS-10 ... 35

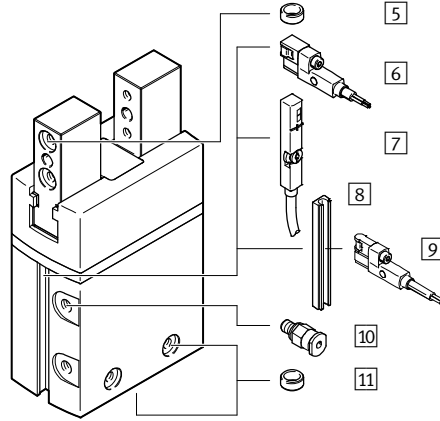

System product for handling and assembly technology

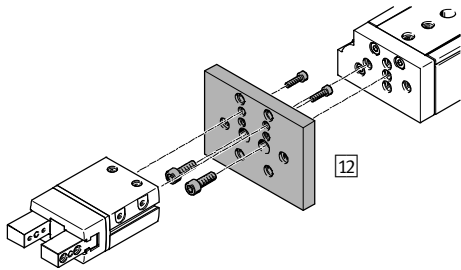

Proportional pressure regulator VPPM

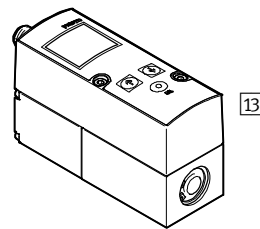

Parallel grippers DHPS

Peripherals overview

Accessories				
	Type	Size	Description	→ Page/Internet
1	Connecting cable NEBU	6 ... 35	For connecting evaluation unit and signal converter	22
2	Evaluation unit SMH-AE1	6	<ul style="list-style-type: none"> For evaluating signals for position sensor SMH-S1 	22
3	Signal converter SVE4	6	<ul style="list-style-type: none"> For evaluating signals for position sensor SMH-S1 	22
4	Position sensor SMH-S1	6	<ul style="list-style-type: none"> Adaptable and integratable sensor technology, for sensing the piston position 	21
5	Centring sleeve ZBH	6 ... 35	<ul style="list-style-type: none"> For centring the gripper fingers on the gripper jaws The delivery scope of the gripper for size 10 and above includes 4 centring sleeves 	21
6	Proximity sensor SMT-8G	10 ... 35	<ul style="list-style-type: none"> For sensing the piston position Proximity sensor does not project past the housing at the bottom 	23
7	Position transmitter SMAT-8M	10 ... 35	<ul style="list-style-type: none"> Continuously senses the position of the piston. Has an analogue output with an output signal in proportion to the piston position. 	23
	Position transmitter SDAT	35		
8	Bondable sensor rail HGP-SL	10 ... 35	<ul style="list-style-type: none"> Enables the use of proximity sensors SME/SMT-10 	21
9	Proximity sensor SMT-10G	10 ... 35	<ul style="list-style-type: none"> For sensing the piston position Proximity sensor does not project past the housing at the bottom With sensor rail HGP-SL10-... 	23
10	Push-in fitting QS	6 ... 35	For connecting compressed air tubing with standard O.D.	quick star
11	Centring sleeve ZBH	6 ... 35	<ul style="list-style-type: none"> For centring the gripper when mounting The scope of delivery of the gripper includes 2 centring sleeves 	21
12	Adapter kit DHAA, HMSV, HAPG, HAPS, HMVA	6 ... 35	Connecting plate between drive and gripper	16
13	Proportional pressure regulator VPPM	6 ... 35	For infinite adjustment of the gripping force	vppm

Parallel grippers DHPS

Type codes

		DHPS	-	16	-	A	-	
Type								
DHPS	Parallel gripper							
Size								
Position sensing								
A	Via proximity sensor							
Gripping force retention								
NO	Opening							
NC	Closing							

Parallel grippers DHPS

Technical data

Function
Double-acting
DHPS-...-A

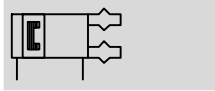

Size
6 ... 35 mm

Total stroke
4 ... 25 mm

 www.festo.com

Function – Variants
Single-acting or
with gripping force retention ...
... opening DHPS-...-NO



... closing DHPS-...-NC



General technical data		6	10	16	20	25	35
Design		Lever Forced motion sequence					
Mode of operation		Double-acting					
Gripper function		Parallel					
Guide		Plain-bearing guide					
Gripping force retention		–	NO, NC	NO, NC	NO, NC	NO, NC	NO, NC
Number of gripper jaws		2					
Max. load per external gripper finger ¹⁾	[g]	10	60	150	250	350	450
Stroke per gripper jaw	[mm]	2	3	5	6.5	7.5	12.5
Pneumatic connection		M3	M3	M3	M5	G1/8	G1/8
Repetition accuracy ²⁾	[mm]	≤ 0.02					
Max. interchangeability	[mm]	± ±0.2					
Max. operating frequency	[Hz]	4		3		2	
Rotational symmetry	[mm]	< Ø 0.2					
Position sensing		Via position sensor		Via proximity sensor, position transmitter			
Type of mounting		Via through-hole and centring sleeve Via female thread and centring sleeve					
Mounting position		Any					

1) Valid for unthrottled operation

2) End-position drift under constant conditions of use with 100 consecutive strokes in the direction of movement of the gripper jaws

Operating and environmental conditions		6	10	16	20	25	35
Min. operating pressure							
DHPS-...-A	[bar]	2					
DHPS-...-A-N	[bar]	–	4				
Max. operating pressure	[bar]	8					
Operating medium		Compressed air in accordance with ISO 8573-1:2010 [7:4:4]					
Note on operating/pilot medium		Operation with lubricated medium possible (in which case lubricated operation will always be required)					
Ambient temperature ¹⁾	[°C]	+5 ... +60					
Corrosion resistance class CRC ²⁾		1					

1) Note operating range of proximity sensors

2) Corrosion resistance class CRC 1 to Festo standard FN 940070

Low corrosion stress. For dry indoor applications or transport and storage protection. Also applies to parts behind covers, in the non-visible interior area, and parts which are covered in the application (e.g. drive trunnions).

Parallel grippers DHPS

Technical data

FESTO

Weight [g]						
Size	6	10	16	20	25	35
DHPS-...-A	19	67	184	380	700	1285
DHPS-...-A-N	-	68	188	387	713	1345

Materials

Sectional view

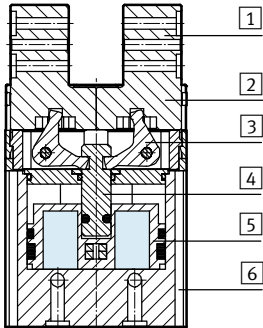

Parallel gripper		
1	Gripper jaw	High-alloy stainless steel
2	Cover cap	Polyamide
3	Reversing lever	Hardened sintered steel
4	Piston rod	Tempered steel
5	Piston	Polyacetal
6	Housing	Hard anodised wrought aluminium alloy
-	Seals	Nitrile rubber
-	Note on materials	Free of copper and PTFE RoHS-compliant

Gripping force [N] at 6 bar

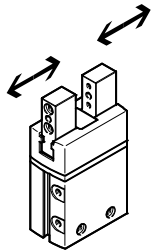

Size	6	10	16	20	25	35	
Gripping force per gripper jaw							
DHPS-...-A	Opening	15	39	105	162	249	483
	Closing	13.5	34.5	96	147	228	450
Total gripping force							
DHPS-...-A	Opening	30	80	210	320	500	970
	Closing	25	70	190	290	450	910

Characteristic load values at the gripper jaws

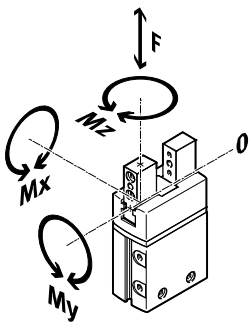

The indicated permissible forces and torques apply to a single gripper jaw. They include the lever arm, additional applied loads due to the workpiece or external gripper fingers and

acceleration forces occurring during movement.

The zero coordinate line (gripper jaw guide) must be taken into consideration for the calculation of torques.

Size	6	10	16	20	25	35	
Max. permissible force F_z	[N]	10	60	150	250	350	450
Max. permissible torque M_x	[Nm]	0.5	3	8	14	30	50
Max. permissible torque M_y	[Nm]	0.5	3	8	14	30	50
Max. permissible torque M_z	[Nm]	0.5	3	8	14	30	50

Parallel grippers DHPS

Technical data

FESTO

Mass moment of inertia [kgm²x10⁻⁴]

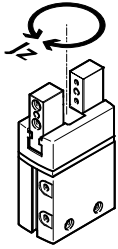

Mass moment of inertia of the parallel gripper in relation to the central axis, without external gripper fingers, without load.

Size	6	10	16	20	25	35
DHPS-...-A	0.01	0.08	0.47	1.49	3.83	12.70
DHPS-...-A-NO	–	0.08	0.47	1.52	3.92	12.83
DHPS-...-A-NC	–	0.08	0.47	1.49	3.84	12.73

Gripper jaw backlash

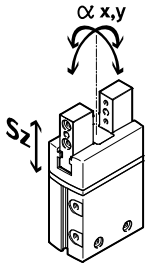

The plain-bearing guide used in the grippers means that there is backlash between the gripper jaws and the housing. The values entered in the table for the backlash were calculated in accordance with the traditional accumulative tolerance method.

Size	6	10	16	20	25	35
Max. gripper jaw backlash Sz	[mm]	≤D.02				
Max. gripper jaw angular backlash ax, ay	[°]	≤1	≤D.5			

Opening and closing times [ms] at 6 bar

Without external gripper fingers

With external gripper fingers

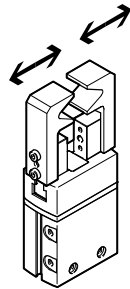
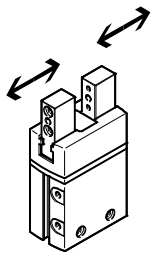

The indicated opening and closing times [ms] were measured at room temperature at an operating pressure of 6 bar with horizontally mounted grippers without additional gripper

fingers. The grippers must be throttled for greater loads [g]. Opening and closing times must then be adjusted accordingly.

Size	6	10	16	20	25	35	
Without external gripper fingers							
DHPS-...-A	Opening	8	21	33	59	48	95
	Closing	17	28	41	87	63	123
DHPS-...-A-NO	Opening	–	19	32	58	45	88
	Closing	–	30	50	97	78	151
DHPS-...-A-NC	Opening	–	58	48	72	68	131
	Closing	–	24	37	62	52	99
With external gripper fingers (as a function of the load)							
DHPS-...	20 g	50	–	–	–	–	–
	100 g	–	50	–	–	–	–
	125 g	–	100	–	–	–	–
	150 g	–	200	–	–	–	–
	200 g	–	–	100	–	–	–
	250 g	–	–	200	–	–	–
	300 g	–	–	300	100	–	–
	350 g	–	–	–	200	–	–
	400 g	–	–	–	300	100	–
	500 g	–	–	–	–	200	–
	600 g	–	–	–	–	300	200
750 g	–	–	–	–	–	300	

Parallel grippers DHPS

Technical data

Gripping force F_H per gripper jaw as a function of operating pressure and lever arm x

The gripping forces as a function of operating pressure and lever arm can be determined from the following graphs.

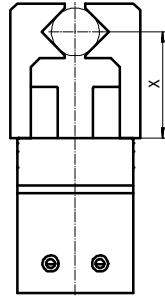

Note
Gripper selection
sizing software
→ www.festo.com

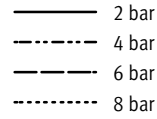

External gripping (closing)

DHPS-06

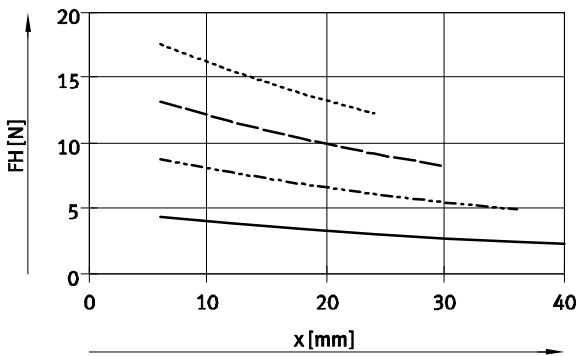

DHPS-10

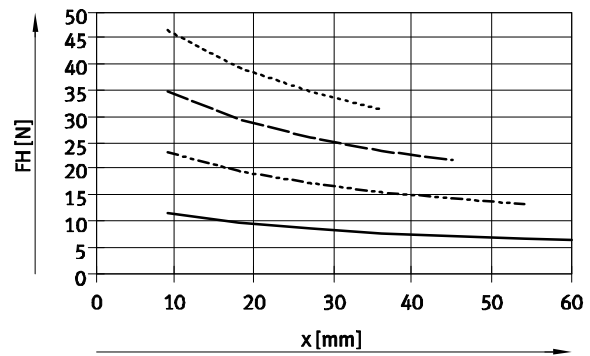

DHPS-16

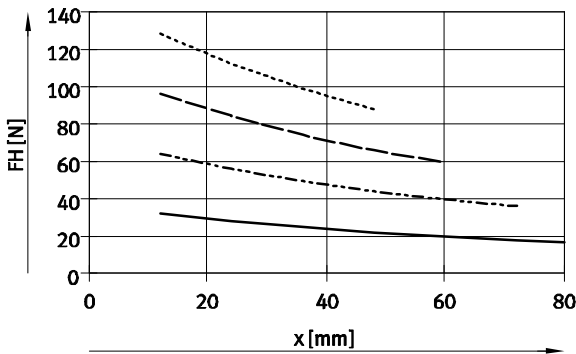

DHPS-20

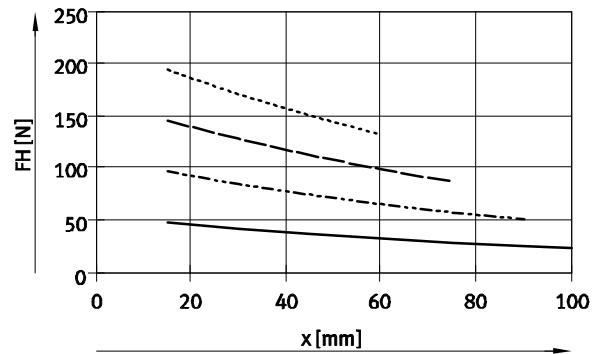

DHPS-25

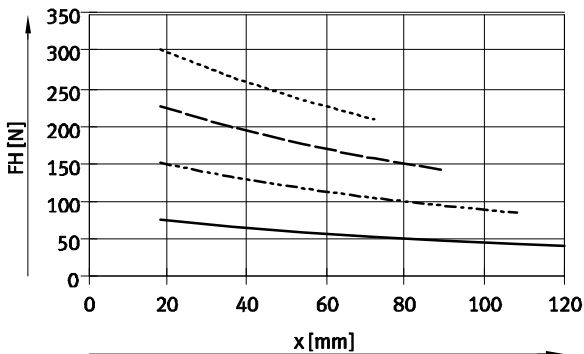

DHPS-35

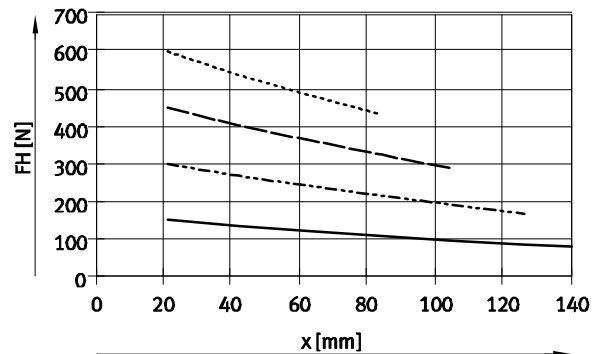

Parallel grippers DHPS

Technical data

Gripping force F_H per gripper jaw as a function of operating pressure and lever arm x

The gripping forces as a function of operating pressure and lever arm can be determined from the following graphs.

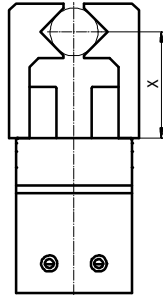

Note
Gripper selection
sizing software
→ www.festo.com

- 2 bar
- - - 4 bar
- · - 6 bar
- · · - 8 bar

Internal gripping (opening)

DHPS-06

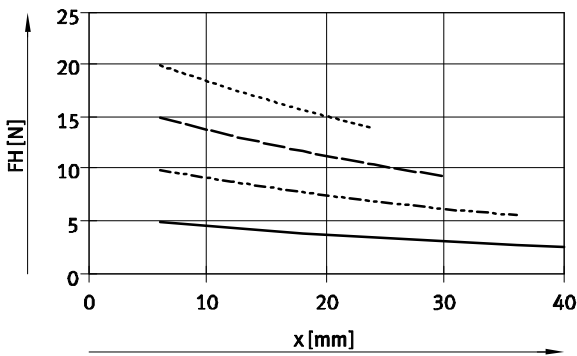

DHPS-10

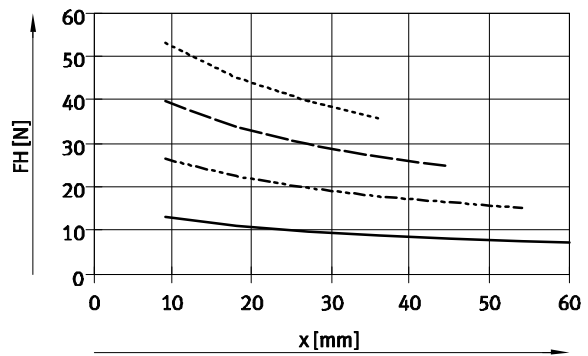

DHPS-16

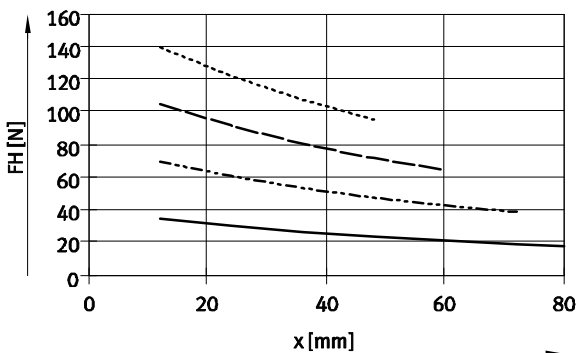

DHPS-20

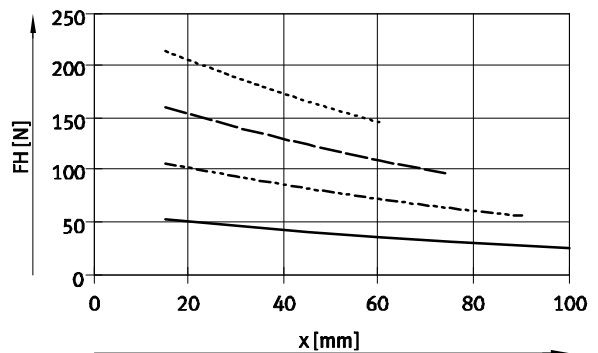

DHPS-25

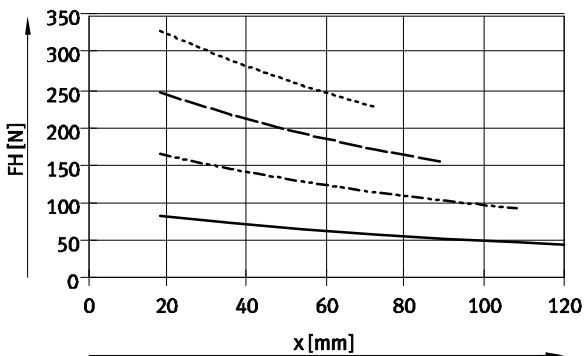

DHPS-35

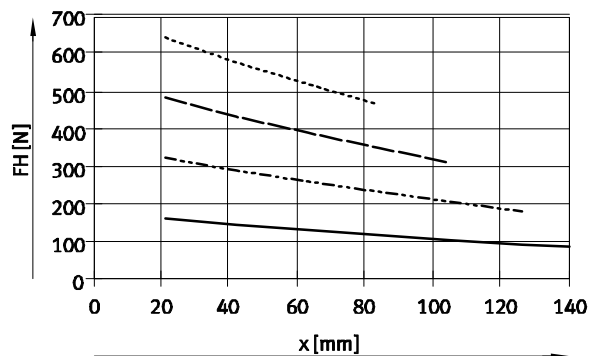

Parallel grippers DHPS

Technical data

Gripping force F_H per gripper jaw at 6 bar as a function of lever arm x and eccentricity a and b

The following formula must be used to calculate the lever arm x with eccentric gripping:

$$x = \sqrt{a^2 + b^2}$$

The gripping force F_H can be read from the graphs (→ 10/11) using the calculated value x .

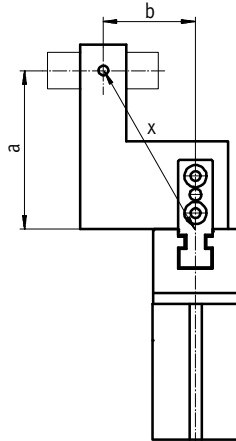

Calculation example

Given:

Distance $a = 25$ mm

Distance $b = 20$ mm

To be calculated:

The gripping force at 6 bar, with a DHPS-16, used as an external gripper

Procedure:

Calculating the lever arm x

$$x = \sqrt{25^2 + 20^2}$$

$$x = 32$$
 mm

The graph (→ 10) gives a value of $F_H = 79$ N for the gripping force.

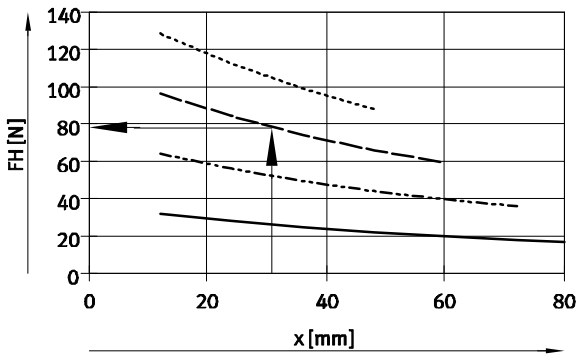

Parallel grippers DHPS

Technical data

Spring force F_F as a function of size and total gripper jaw stroke l

Gripping force retention for DHPS-...-N...

The spring forces F_F as a function of gripper jaw stroke l can be determined from the following graph.

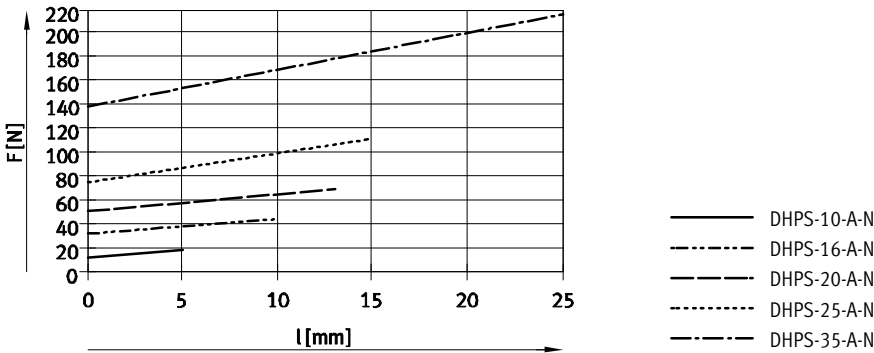
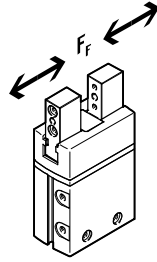

Spring force F_F as a function of size, gripper jaw stroke l and lever arm x per gripper finger

The lever arm x must be taken into consideration when determining the actual spring force F_{Ftotal} . The formulae for calculating the spring force are provided in the table below.

Gripping force retention	Size	F_{Ftotal} per gripper finger
NO, NC	10	$-0.02 * x + 0.5 * F_F$
	16	$-0.08 * x + 0.5 * F_F$
	20	$-0.1 * x + 0.5 * F_F$
	25	$-0.12 * x + 0.5 * F_F$
	35	$-0.19 * x + 0.5 * F_F$

Determination of the actual gripping forces F_{Gr} for DHPS-...-NO and DHPS-...-NC as a function of application

The parallel grippers with integrated spring type DHPS-...-NO (opening gripping force retention) and DHPS-...-NC (closing gripping force retention) can be used as

- single-acting grippers

- grippers with supplementary gripping force and
- grippers with gripping force retention depending on requirements.

In order to calculate the available gripping forces F_{Gr} (per gripper jaw), the gripping force (F_H) and spring force (F_{Ftotal}) must be combined accordingly.

Application

Single-acting	Supplementary gripping force	Gripping force retention
<ul style="list-style-type: none"> • Gripping with spring force: $F_{Gr} = F_{Ftotal}$ • Gripping with pressure force: $F_{Gr} = F_H - F_{Ftotal}$ 	<ul style="list-style-type: none"> • Gripping with pressure and spring force: $F_{Gr} = F_H + F_{Ftotal}$ 	<ul style="list-style-type: none"> • Gripping with spring force: $F_{Gr} = F_{Ftotal}$

Parallel grippers DHPS

Technical data

FESTO

Dimensions

Download CAD data → www.festo.com

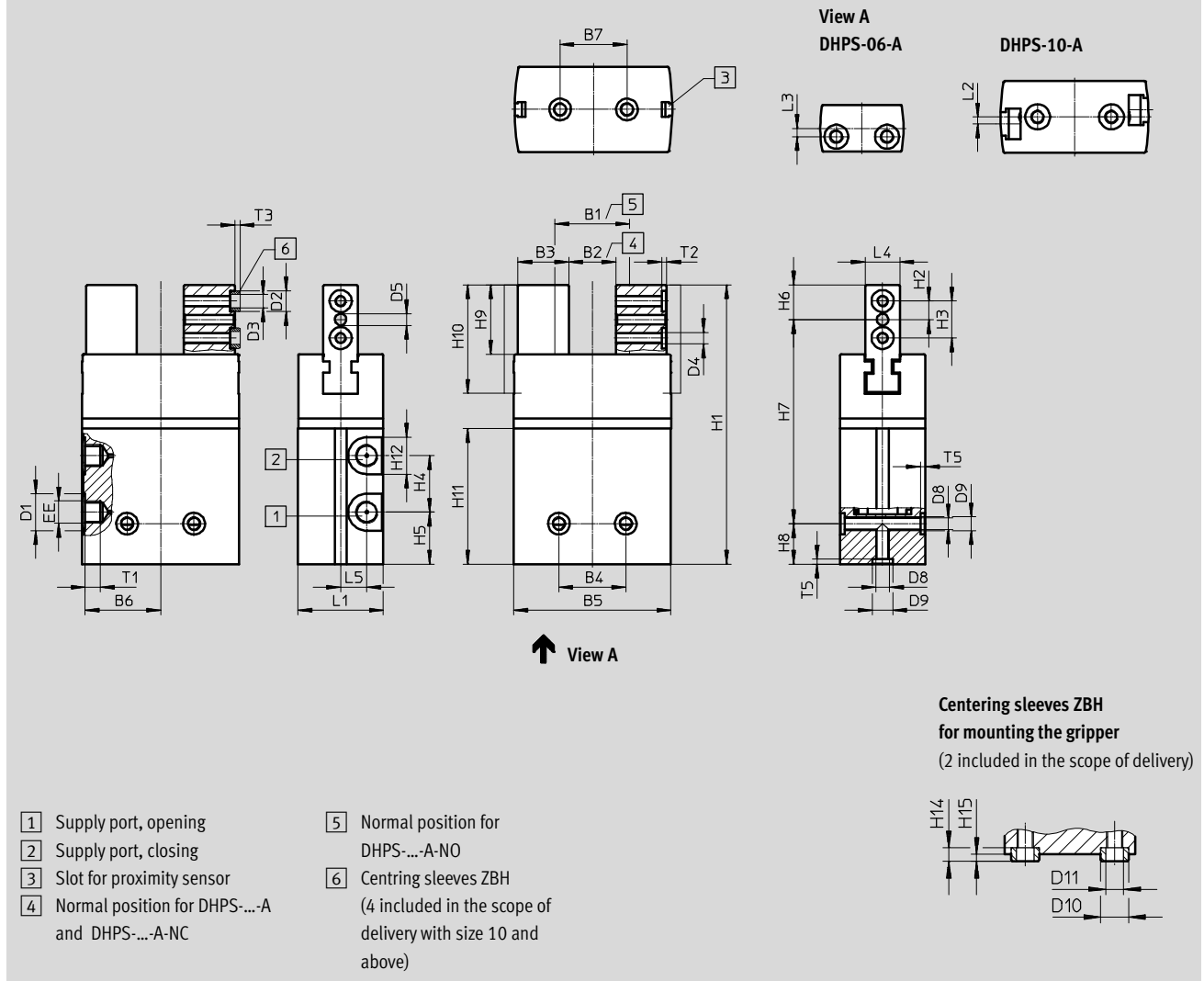

Size	B1	B2	B3	B4 ¹⁾	B5	B6	B7 ¹⁾	D1	D2	D3	D4	D5	D8	D9
[mm]	±0.5	±0.5	-0.03		±0.1			∅	∅ H8/h7	∅		∅ H8	∅ +0,1	
6	10	6	5.5	11	18	8.65	11	7	–	–	M2	1.5	2.5	M3
10	21.8	15.8	7	16	32	15.4	16	7	5	3.2	M3	2	2.5	M3
16	27.8	17.8	13	25	47	22.65	25	7	7	5.3	M4	3	3.3	M4
20	30	17	17.5	25	55.6	26.65	25	10	7	5.3	M4	4	3.3	M4
25	35.4	20.4	22	29	68.2	32.65	29	16	9	6.4	M5	4	5.1	M6
35	56	31	27	33	88	42.25	33	16	9	6.4	M6	5	6.4	M8

1) Tolerance for centring hole ±0.02 mm; tolerance for thread ±0.1 mm

Parallel grippers DHPS

Technical data

Size [mm]	D10 ∅ h7	D11 ∅	EE	H1	H2	H3 ¹⁾	H4	H5	H6	H7 ±0.2	H8 ²⁾	H9	H10
6	–	–	M3	45.5	2.9	5.8	15	4	5	33	7.5	9.55	15.8
10	5	3.2	M3	66	4	8	15.5	10.5	7.5	51	7.5	15.2	23
16	7	5.3	M3	80	5.5	11	18	11	10	62.5	7.5	20	32.5
20	7	5.3	M5	101	7	14	23	16	12.5	81	7.5	25	39.5
25	9	6.4	G $\frac{1}{8}$	121	8	16	24.5	22.5	15	88.5	17.5	30	47
35	9	6.4	G $\frac{1}{8}$	142	8.5	17	29	24	16	108.5	17.5	32	53

Size [mm]	H11	H12	H14 –0.2	H15 –0.3	L1	L2	L3 ¹⁾	L4 –0.05	L5	T1 +0.5	T2 +0.1	T3 –0.2	T5 +0.1
6	25.3	7	–	–	10 ^{+0,1}	–	1.8	5	1.5	3.5	–	–	1.2
10	35	7	2.4	1.2	15.5 ^{+0,1}	1.5	–	7	5	5	1.2	1.2	1.2
16	38.1	7	3	1.4	22 ^{+0,1}	–	–	10	7	6	1.6	1.4	1.6
20	50	10	3	1.4	30±0,1	–	–	12	9	6	1.6	1.4	1.6
25	58.8	16	4	1.9	37±0,1	–	–	15	11.3	6.5	2.1	1.9	2.1
35	65.3	16	4	1.9	45 ^{+0,1}	–	–	20	13.5	6.5	2.1	1.9	2.6

1) Tolerance for centring hole ±0.02 mm; tolerance for thread ±0.1 mm

2) Tolerance for centring hole –0.05 mm; tolerance for thread ±0.1 mm

Ordering data						
Size [mm]	Double-acting without compression spring		Single-acting or with gripping force retention			
	Part No.	Type	Opening		Closing	
			Part No.	Type	Part No.	Type
6	1254039	DHPS-06-A	–		–	
10	1254040	DHPS-10-A	1254041	DHPS-10-A-NO	1254042	DHPS-10-A-NC
16	1254043	DHPS-16-A	1254044	DHPS-16-A-NO	1254045	DHPS-16-A-NC
20	1254046	DHPS-20-A	1254047	DHPS-20-A-NO	1254048	DHPS-20-A-NC
25	1254049	DHPS-25-A	1254050	DHPS-25-A-NO	1254051	DHPS-25-A-NC
35	1254052	DHPS-35-A	1254053	DHPS-35-A-NO	1254054	DHPS-35-A-NC

Parallel grippers DHPS



Accessories



Adapter kit
HMSV, HAPG, HAPS

Material:
Wrought aluminium alloy
Free of copper and PTFE
RoHS-compliant

 Note
The kit includes the individual mounting interface as well as the necessary mounting material.

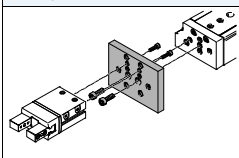
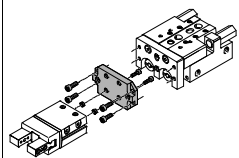
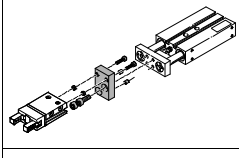
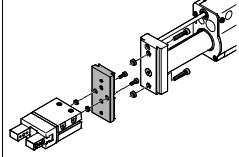
Permissible drive/gripper combinations with adapter kit						Download CAD data → www.festo.com	
Combination	Drive Size	Gripper Size	Mounting option		Adapter kit		
					CRC ¹⁾	Part No.	Type
DGSL/DHPS	DGSL	DHPS			HMSV		
	4, 6	6	■	■	2	548783	HMSV-53
	8, 10	10	■	■		548784	HMSV-54
	12, 16	16	■	■		548785	HMSV-55
	20, 25	20, 25	■	■		548786	HMSV-56
SLT/DHPS	SLT	DHPS			HAPS		
	6	6	■	–	2	178447	HAPS-1
	16	10	■	–		178449	HAPS-3
	20	16, 20	■	–		178450	HAPS-4
	25	25	■	–		178451	HAPS-5
DPZ/DHPS	DPZ	DHPS			HAPG		
	10, 16	10	■	–	2	163250	HAPG-1
	16	16, 20	■	–		163251	HAPG-2
	20	16, 20	■	–		163252	HAPG-3
	25, 32	25	■	–		163253	HAPG-4
HMP/DHPS	HMP	DHPS			HMSV		
	Direct mounting				2		
	16, 20	10	■	■		177666	HMSV-20
	16, 20, 25	16, 20	■	■		177761	HMSV-21
	16, 20, 25, 32	25	■	■		177762	HMSV-22
	25	35	■	■		177763	HMSV-23
	32	35	■	■		177764	HMSV-24
	Dovetail mounting				2		
	16, 20	10	■	■		177767	HMSV-27
	16, 20, 25	16, 20	■	■		177768	HMSV-28
	16, 20, 25, 32	25	■	■		177769	HMSV-29
	25	35	■	■		177770	HMSV-30
	32	35	■	■		178211	HMSV-31

1) Corrosion resistance class CRC 2 to Festo standard FN 940070
Moderate corrosion stress. Indoor applications in which condensation may occur. External visible parts with primarily decorative requirements for the surface and which are in direct contact with the ambient atmosphere typical for industrial applications.

Parallel grippers DHPS



Accessories

FESTO

Adapter kit
HMSV, HAPG, HMVA

Material:
Wrought aluminium alloy
Free of copper and PTFE
RoHS-compliant

 Note
The kit includes the individual mounting interface as well as the necessary mounting material.

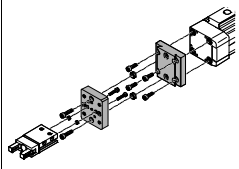
Permissible drive/gripper combinations with adapter kit					Download CAD data → www.festo.com		
Combination	Drive Size	Gripper Size	Mounting option		Adapter kit		
					CRC ¹⁾	Part No.	Type
DGPL, DGE-..., DGEA/DHPS	DG...	DHPS				HMVA, HAPG, HMSV	
	Direct mounting						
	18 ²⁾ , 25, 32 ³⁾	6	■	■	2	196788	HMVA-DLA18/25
			■	■		192706	HAPG-37-S1
	40	6	■	■		196790	HMVA-DLA40
			■	■		192706	HAPG-37-S1
	18 ²⁾ , 25, 32 ³⁾	10	■	■		196788	HMVA-DLA18/25
			■	■		192705	HAPG-36-S1
	40	10	■	■		196790	HMVA-DLA40
			■	■		192705	HAPG-36-S1
	18 ²⁾ , 25, 32 ³⁾	16	■	■		196788	HMVA-DLA18/25
			■	■		193922	HAPG-37-S4
	40	16	■	■		196790	HMVA-DLA40
			■	■		193922	HAPG-37-S4
	Dovetail mounting						
	18 ²⁾ , 25	10	■	■	2	196788	HMVA-DLA18/25
			■	■		177767	HMSV-27
	32 ³⁾	10	■	■		196789	HMVA-DL32
			■	■		177767	HMSV-27
	40	10	■	■		196790	HMVA-DLA40
			■	■		177767	HMSV-27
18 ²⁾ , 25	16	■	■	196788		HMVA-DLA18/25	
		■	■	177768		HMSV-28	
32 ³⁾	16	■	■	196789		HMVA-DL32	
		■	■	177768		HMSV-28	
40	16	■	■	196790		HMVA-DLA40	
		■	■	177768		HMSV-28	
32 ³⁾	25	■	■	196790		HMVA-DL32	
		■	■	177769		HMSV-29	
40	25	■	■	196790		HMVA-DLA40	
		■	■	177769		HMSV-29	
40	35	■	■	196790	HMVA-DLA40		
		■	■	177770	HMSV-30		

- 1) Corrosion resistance class CRC 2 to Festo standard FN 940070
Moderate corrosion stress. Indoor applications in which condensation may occur. External visible parts with primarily decorative requirements for the surface and which are in direct contact with the ambient atmosphere typical for industrial applications.
- 2) Only for DGEA-...
- 3) Only for DGPL

Parallel grippers DHPS



Accessories

FESTO

Adapter kit
DHAA, HAPG

Material:
Wrought aluminium alloy
Free of copper and PTFE
RoHS-compliant

 Note
The kit includes the individual mounting interface as well as the necessary mounting material.

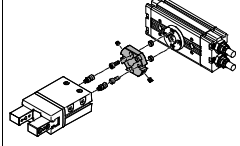
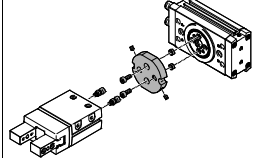
Permissible drive/gripper combinations with adapter kit					Download CAD data → www.festo.com		
Combination	Drive Size	Gripper Size	Mounting option		Adapter kit		
					CRC ¹⁾	Part No. Type	
	DRQD-...-FW	DHPS			HAPG		
	6, 8, 12	6	■	■	2	187568 HAPG-34	
	16 ²⁾	6	■	■		187566 HAPG-SD2-12	
	16 ²⁾	10	■	■		184477 HAPG-SD2-1	
	16 ²⁾	16	■	■		184478 HAPG-SD2-2	
	20 ²⁾	16, 20	■	■		184479 HAPG-SD2-3	
	20 ²⁾	25	■	■		184480 HAPG-SD2-4	
	25 ³⁾	16, 20	■	■		184482 HAPG-SD2-6	
	25 ³⁾	25	■	■		184483 HAPG-SD2-7	
	32 ³⁾	25	■	■		184485 HAPG-SD2-9	
	32 ³⁾	35	■	■		184486 HAPG-SD2-10	
	40, 50	35	■	■	526027 HAPG-SD2-21		
	DRQD-...ZW	DHPS			HAPG		
	16	10	■	■	2	163267 HAPG-18	
	16	16, 20	■	■		163268 HAPG-19	
	20	16, 20	■	■		163269 HAPG-20	
	20	25	■	■		163270 HAPG-21	
	25	25	■	■		163271 HAPG-22	
		DRRD	DHPS			DHAA	
		8	6	■	■	2	2808892 DHAA-G-Q11-8-B1-6
10		6	■	■	2807644 DHAA-G-Q11-10-B1-6		
12		6	■	■	2805783 DHAA-G-Q11-12-B1-6		
12		10	■	■	2802687 DHAA-G-Q11-12-B1-10		
16		10	■	■	2190504 DHAA-G-Q11-16-B1-10		
16		16	■	■	2190393 DHAA-G-Q11-16-B1-16		
16		20	■	■	2187838 DHAA-G-Q11-16-B1-20		
20		16	■	■	2190284 DHAA-G-Q11-20-B1-16		
20		20	■	■	2187713 DHAA-G-Q11-20-B1-20		
20		25	■	■	2185820 DHAA-G-Q11-20-B1-25		
25		16	■	■	1471634 DHAA-G-Q11-25-B1-16		
25		20	■	■	1722652 DHAA-G-Q11-25-B1-20		
25		25	■	■	1725707 DHAA-G-Q11-25-B1-25		
32		25	■	■	2186909 DHAA-G-Q11-32-B1-25		
32		35	■	■	2187316 DHAA-G-Q11-32-B1-35		
35, 40		35	■	■	2187606 DHAA-G-Q11-35/40-B1-35		

- Corrosion resistance class CRC 2 to Festo standard FN 940070
Moderate corrosion stress. Indoor applications in which condensation may occur. External visible parts with primarily decorative requirements for the surface and which are in direct contact with the ambient atmosphere typical for industrial applications.
- Possible in combination with DRQD-...-E422 (flanged shaft with energy through-feed).
- Possible in combination with DRQD-...-E444 (flanged shaft with energy through-feed).

Parallel grippers DHPS

Accessories

FESTO

Adapter kit
HAPG

Material:
Wrought aluminium alloy
Free of copper and PTFE
RoHS-compliant

 Note
The kit includes the individual mounting interface as well as the necessary mounting material.

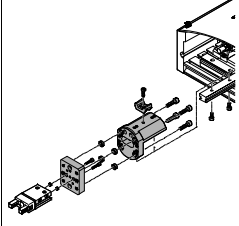
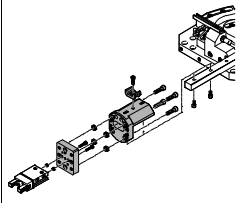
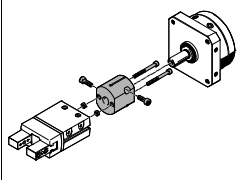
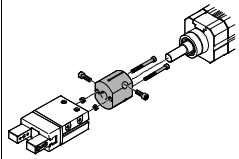
Permissible drive/gripper combinations with adapter kit						Download CAD data → www.festo.com	
Combination	Drive	Gripper	Mounting option		Adapter kit		
			Size	Size	CRC ¹⁾	Part No.	Type
	HSP	DHPS			2		
	12	6	■	–		192709	HAPG-60-S1
						540881	HAPG-70-B
	16	6	■	–		192706	HAPG-37-S1
						540882	HAPG-71-B
	16	10	■	–		192705	HAPG-36-S1
				540882	HAPG-71-B		
	25	10	■	–	192705	HAPG-36-S1	
					540883	HAPG-72-B	
	25	16	■	–	193922	HAPG-37-S4	
					540883	HAPG-72-B	
	HSW	DHPS			2		
	12, 16	6	■	–		192706	HAPG-37-S1
						540882	HAPG-71-B
	12, 16	10	■	–		192705	HAPG-36-S1
					540882	HAPG-71-B	
	DSM:....FW	DHPS			2	187568	HAPG-34
			■	■			
	DSM:...	DHPS			2		
	12	10	■	■		163266	HAPG-17
	16	10	■	■		163267	HAPG-18
	16	16, 20	■	■		163268	HAPG-19
	25	16, 20	■	■		163269	HAPG-20
	25	25	■	■		163270	HAPG-21
	32	25	■	■		163271	HAPG-22
	DSL	DHPS			2		
	16	10	■	■		163266	HAPG-17
	20	10	■	■		163267	HAPG-18
	20	16, 20	■	■		163268	HAPG-19
	25	16, 20	■	■		163269	HAPG-20
	25	25	■	■		163270	HAPG-21
	32	25	■	■		163271	HAPG-22

1) Corrosion resistance class CRC 2 to Festo standard FN 940070
Moderate corrosion stress. Indoor applications in which condensation may occur. External visible parts with primarily decorative requirements for the surface and which are in direct contact with the ambient atmosphere typical for industrial applications.

Parallel grippers DHPS



Accessories



Adapter kit
HMSV, HAPG

Material:
Wrought aluminium alloy
Free of copper and PTFE
RoHS-compliant

 Note
The kit includes the individual mounting interface as well as the necessary mounting material.

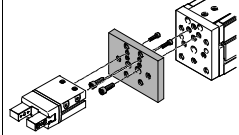
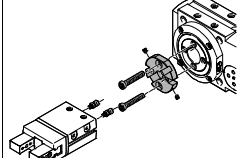
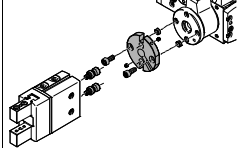
Permissible drive/gripper combinations with adapter kit						Download CAD data → www.festo.com	
Combination	Drive Size	Gripper Size	Mounting option		Adapter kit		
					CRC ¹⁾	Part No.	Type
EGSL/DHPS	EGSL	DHPS			HMSV		
	35	6	■	■	2	548783	HMSV-53
	35	10	■	■		1088262	HMSV-70
			■	■		548784	HMSV-54
	45, 55	16	■	■		1088262	HMSV-70
75	20, 25	■	■	548785	HMSV-55		
					548786	HMSV-56	
ERMB/DHPS	ERMB	DHPS			HAPG		
	20	16, 20	■	■	2	184479	HAPG-SD2-3
	25	16, 20	■	■		184482	HAPG-SD2-6
	20	25	■	■		184480	HAPG-SD2-4
	25	25	■	■		184483	HAPG-SD2-7
	32	25	■	■		184485	HAPG-SD2-9
	32	35	■	■		184486	HAPG-SD2-10
EHMB/DHPS	EHMB	DHPS			HAPG		
	20	25	■	■	2	184485	HAPG-SD2-9
	20	35	■	■		184486	HAPG-SD2-10
	25, 32	35	■	■		526027	HAPG-SD2-21

1) Corrosion resistance class CRC 2 to Festo standard FN 940070
Moderate corrosion stress. Indoor applications in which condensation may occur. External visible parts with primarily decorative requirements for the surface and which are in direct contact with the ambient atmosphere typical for industrial applications.

Parallel grippers DHPS

Accessories

Sensor rail HGP-SL

can be glued into place

Material:

Wrought aluminium alloy

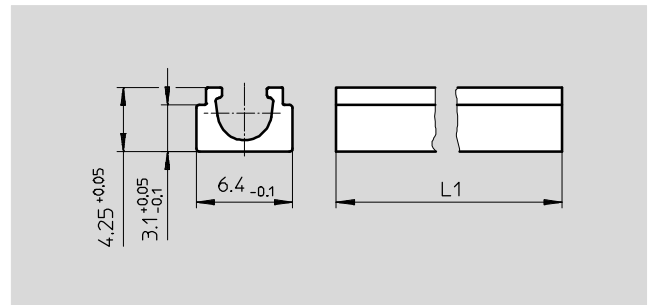
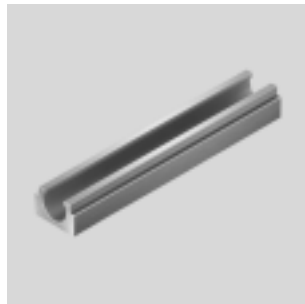

Dimensions and ordering data					
For size [mm]	L1	Weight [g]	Part No.	Type	
10	35	1.4	535582	HGP-SL-10-10	
16	38	1.5	535583	HGP-SL-10-16	
20	50	2.0	535584	HGP-SL-10-20	
25	58	2.3	535585	HGP-SL-10-25	
35	65	2.6	535586	HGP-SL-10-35	

Ordering data						
	For size [mm]	Description	Weight [g]	Part No.	Type	PU ¹⁾
Centring sleeve ZBH			Technical data → Internet: zbh			
	10	For centring the gripper fingers on the gripper jaws	1	189652	ZBH-5	10
	16, 20		1	186717	ZBH-7	
	25, 35		1	150927	ZBH-9	
	6, 10	For centring the gripper when mounting	1	189652	ZBH-5	
	16, 20		1	186717	ZBH-7	
	25		1	150927	ZBH-9	
	35		1	189653	ZBH-12	

1) Packaging unit

Ordering data					
Type	For size	Weight [g]	Part No.	Type	
Position sensor SMH-S1					
Technical data → Internet: smh-s1					
	6	20	175710	SMH-S1-HGP06	

Installation instructions for position sensor SMH-S1

To guarantee the functionality of the position sensor, the outlet for the cable and the compressed air tubing must be facing the same direction during installation.

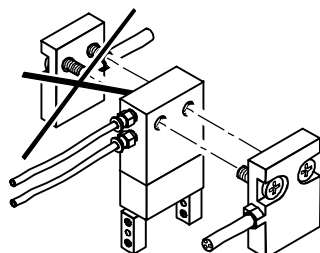

Parallel grippers DHPS

Accessories



FESTO

Signal converter/evaluation unit for position sensor SMH-S1



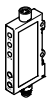

Signal converter SVE4 Evaluation unit SMH-AE1

- Converts analogue signals into switching points
- Switching function freely programmable with teach-in
- Threshold value, hysteresis or window comparator
- Converts analogue signals into switching points
- With 3 potentiometers for setting 3 switching points

Ordering data

Type	For size	Input connection	Output connection	Switching output	Weight [g]	Part No.	Type
Signal converter SVE4						Technical data → Internet: sve4	
	6	Socket M8x1, 4-pin	Plug M8x1, 4-pin	2x PNP	19	544216	SVE4-HS-R-HM8-2P-M8
				2x NPN		544219	SVE4-HS-R-HM8-2N-M8
Evaluation unit SMH-AE1						Technical data → Internet: smh-ae	
	6	Socket M8x1, 4-pin	Plug M12x1, 5-pin	3x PNP	170	175708	SMH-AE1-PS3-M12
				3x NPN		175709	SMH-AE1-NS3-M12

Ordering data – Connecting cables

	Electrical connection, left	Electrical connection, right	Cable length [m]	Part No.	Type
Connection between position sensor and signal converter/evaluation unit					
	Straight socket, M8x1, 4-pin	Straight plug, M8x1, 4-pin	2.5	554035	NEBU-M8G4-K-2.5-M8G4
Connection between evaluation unit and controller					
	Straight socket, M12x1, 5-pin	Cable, open end, 5-wire	2.5	541330	NEBU-M12G5-K-2.5-LE5
			5	541331	NEBU-M12G5-K-5-LE5
Connection between signal converter and controller					
	Straight socket, M8x1, 4-pin	Cable, open end, 4-wire	2.5	541342	NEBU-M8G4-K-2.5-LE4
			5	541343	NEBU-M8G4-K-5-LE4
	Angled socket, M8x1, 4-pin	Cable, open end, 4-wire	2.5	541344	NEBU-M8W4-K-2.5-LE4
			5	541345	NEBU-M8W4-K-5-LE4

Parallel grippers DHPS

Accessories

FESTO



Proximity sensor for size 10 ... 35

Ordering data – Proximity sensors for T-slot, magneto-resistive						Technical data → Internet: smt	
	Type of mounting	Electrical connection, connection direction	Switching output	Cable length [m]	Part No.	Type	
N/O contact							
	Insertable in the slot lengthwise	Cable, 3-wire, lateral	PNP	2.5	547859	SMT-8G-PS-24V-E-2,5Q-OE	
		Plug M8x1, 3-pin, lateral		0.3	547860	SMT-8G-PS-24V-E-0,3Q-M8D	

Proximity sensor for size 10 ... 35, with sensor rail HGP-SL10-...

Ordering data – Proximity sensors for C-slot, magneto-resistive						Technical data → Internet: smt	
	Type of mounting	Electrical connection, connection direction	Switching output	Cable length [m]	Part No.	Type	
N/O contact							
	Insertable in the slot lengthwise	Cable, 3-wire, lateral	PNP	2.5	547862	SMT-10G-PS-24V-E-2,5Q-OE	
		Plug M8x1, 3-pin, lateral		0.3	547863	SMT-10G-PS-24V-E-0,3Q-M8D	

Ordering data – Connecting cables

Ordering data – Connecting cables					Technical data → Internet: nebu	
	Electrical connection, left	Electrical connection, right	Cable length [m]	Part No.	Type	
	Straight socket, M8x1, 3-pin	Cable, open end, 3-wire	2.5	541333	NEBU-M8G3-K-2.5-LE3	
			5	541334	NEBU-M8G3-K-5-LE3	
	Angled socket, M8x1, 3-pin	Cable, open end, 3-wire	2.5	541338	NEBU-M8W3-K-2.5-LE3	
			5	541341	NEBU-M8W3-K-5-LE3	

Position transmitter



The position transmitter continuously senses the position of the piston.

It has an analogue output with an output signal in proportion to the piston position.

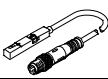
Ordering data – Position transmitters for T-slot

Ordering data – Position transmitters for T-slot							Technical data → Internet: position transmitter		
	For size	Position measuring range	Analogue output		Type of mounting	Electrical connection	Cable length [m]	Part No.	Type
			[V]	[mA]					
	10 ... 35	0 ... 40	0 ... 10	–	Insertable in slot from above	Plug M8x1, 4-pin, in-line	0.3	553744	SMAT-8M-U-E-0,3-M8D
	35	0 ... 50	–	4 ... 20					

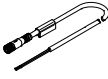
Ordering data – Connecting cables

Ordering data – Connecting cables					Technical data → Internet: nebu	
	Electrical connection, left	Electrical connection, right	Cable length [m]	Part No.	Type	
	Straight socket, M8x1, 4-pin	Cable, open end, 4-wire	2.5	541342	NEBU-M8G4-K-2.5-LE4	
			5	541343	NEBU-M8G4-K-5-LE4	
	Angled socket, M8x1, 4-pin	Cable, open end, 4-wire	2.5	541344	NEBU-M8W4-K-2.5-LE4	
			5	541345	NEBU-M8W4-K-5-LE4	