

Mini slides DGSL



Mini slides DGSL

Key features

FESTO

General

- Double-acting drives
- Wide range of mounting options
- System product for handling and assembly technology
- Highly flexible thanks to a wide range of assembly and connection options on:
 - Drive body, slide, yoke plate

The technology in detail

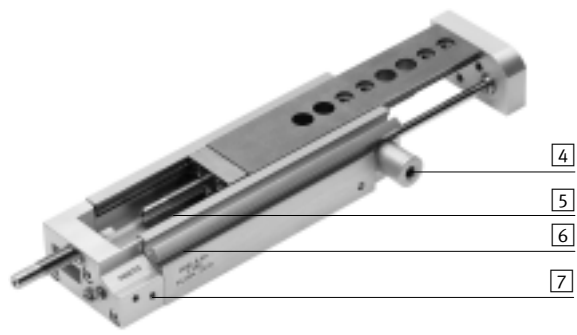

1 Cushioning



- Choice of five cushioning types:
 - Elastic cushioning without metal end position (P)
 - Elastic cushioning without metal end position, short design (E)
 - Elastic cushioning with metal end position (P1)
 - Shock absorber (Y3)
 - Shock absorber with reducing sleeve (Y11)
- Alternative:
 - Without cushioning (N)

2 Cover

→ 45



- The cover stops foreign parts or dirt getting into the guide
- The cover comes in different lengths and can be trimmed as required by the customer

3 Coarse stroke adjustment

→ 10



- The end stop for the advanced end position can be adjusted mechanically, for example to shorten the stroke

4 Clamping unit

→ 40



- Mechanical clamping, for fixing the slide in any position; frictional locking (C)

4 End-position locking

→ 40



- Mechanical locking when the end position is reached, for fixing the slide in the unpressurised, retracted state; positive locking (E3)

5 Innovative guide unit

- Wide roller track, which provides extremely high rigidity
- High load capacity
- High precision
- Housing and steel slide form a guide: there are no accumulative tolerances

6 Position sensing

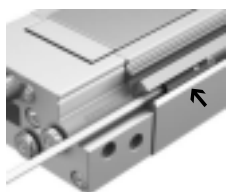

- Proximity sensors can be integrated, so there are no projecting parts
- Two slots for mounting
- Clearly visible from the side and from above

7 Supply ports



- Choice of two sides:
 - On the front
 - On the side

Mini slides DGSL

System example

The technology in detail

Intermediate position module

→ 46



The intermediate position module enables an additional adjustable position within the stroke range.

- 1 Shock absorber retainer
- 2 Intermediate position module

- The symmetric design enables the intermediate position to be approached during the advance or return stroke, depending on the installation position
- Intermediate position can be travelled through from the end position
- Travel can be continued directly from the intermediate position
- Easy to assemble
- Sensing of the stop lever position possible

System product for handling and assembly technology

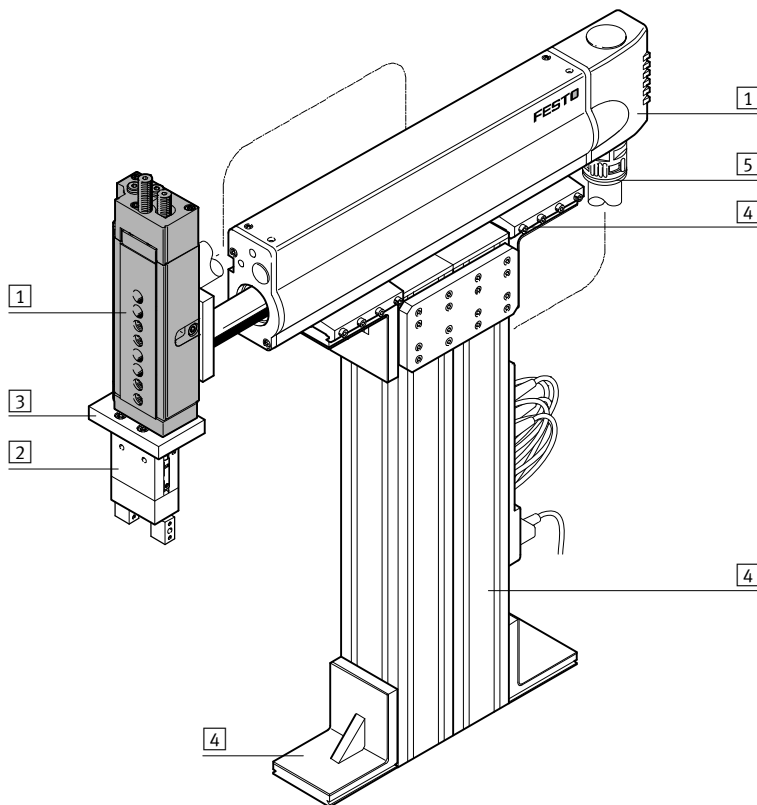

System components and accessories		
	Description	→ Page/Internet
1	Drives	Wide range of combinations possible within handling and assembly technology drive
2	Grippers	Wide range of variations possible within handling and assembly technology gripper
3	Adapters	For drive/drive connections 52
		For drive/gripper connections gripper
4	Basic components	Profiles and profile connections as well as profile/drive connections basic component
5	Installation components	For a clear, safe layout of electrical cables and tubing installation component
-	Axes	Wide range of combinations possible within handling and assembly technology axis
-	Motors	Servo and stepper motors, with or without gear unit motor

Mini slides DGSL

Peripherals overview

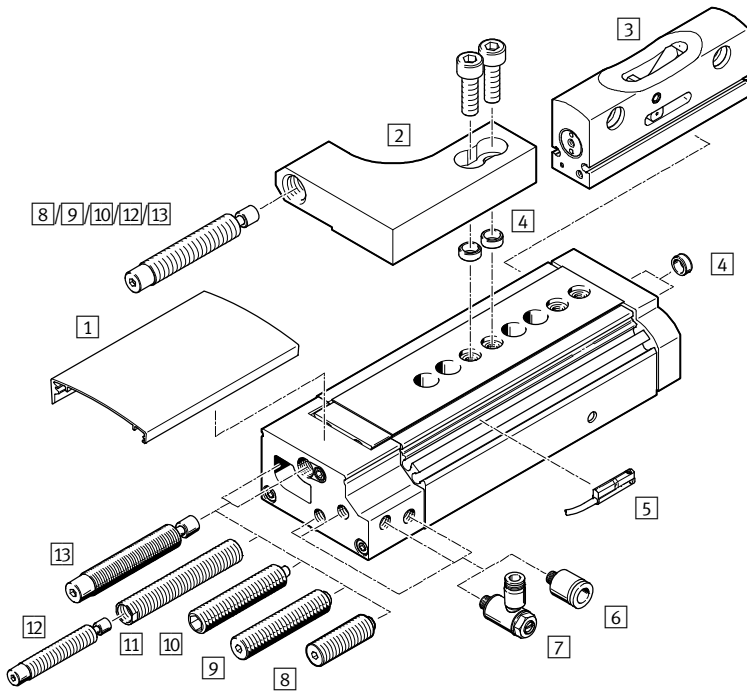

 Note
Operation without cushioning components is not permitted.

Accessories			
	Description	→ Page/Internet	
1	Cover DADS	<ul style="list-style-type: none"> For protection, to stop foreign parts or dirt getting into the guide The cover can be trimmed as required by the customer 	45
2	Shock absorber retainer DADP	<ul style="list-style-type: none"> Attachment for the shock absorber For positioning and cushioning the intermediate position 	48
3	Intermediate position module DADM	With stop lever for the intermediate position	46
4	Centring sleeve ZBH	For centring loads and attachments (centring sleeves are included in the scope of delivery of the mini slide)	50
5	Proximity sensor SME/SMT-10	For position sensing. Can be integrated in the sensor slot, so there are no projecting parts	50
6	Push-in fitting QSM	For connecting compressed air tubing with standard O.D.	50
7	One-way flow control valve GRLA	For regulating speed	50
8	Cushioning E	<ul style="list-style-type: none"> Flexible stop for medium loads at medium speed (short design) 	49
9	Cushioning P	<ul style="list-style-type: none"> Flexible stop for medium loads at medium speed (standard design) 	49
10	Cushioning with stop P1	Precision metal stop for small loads at low speed	49
11	Reducing sleeve DAYH	For installing a smaller shock absorber. For applications where the cushioning energy lies between the cushioning Y3 and P1	49
12	Shock absorber DYSW	→ 12 (shock absorber selection)	49
13	Cushioning with shock absorber Y3	For large loads and high speed. Ensures precise, metal-to-metal contact after the cushioning	49

Mini slides DGSL

Type codes

DGSL – 10 – 100 – E3 – Y3 – A

Type	
Double-acting	
DGSL	Mini slide
Size	
Stroke [mm]	
Clamping unit	
C	Attached
End-position locking	
E3	With piston rod in retracted position
Cushioning	
P	Elastic cushioning without metal end position, at both ends
P1	Elastic cushioning with metal end position, at both ends
Y3	Progressive shock absorber, at both ends
E	Elastic cushioning without metal end position, at both ends, short design
Y11	Progressive shock absorber with reducing sleeve, at both ends
N	No cushioning
Position sensing	
A	Via proximity sensor

Mini slides DGSL

Technical data

FESTO

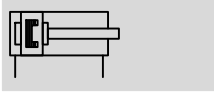

Function



Wearing parts kits

→ 45



-  - Size
4 ... 25
-  - Stroke length
10 ... 200 mm

General technical data				4	6	8	10	12	16	20	25
Size				4	6	8	10	12	16	20	25
Pneumatic connection				M3			M5		G1/8		
Design				Scotch yoke system							
Guide				Ball bearing cage guide							
Type of mounting				With through-hole							
				Via female thread							
Cushioning	P			Elastic cushioning without metal end position, at both ends							
	E			Elastic cushioning without metal end position, at both ends, short design							
	P1			Elastic cushioning with metal end position, at both ends, adjustable							
	Y3			-		Progressive shock absorber, at both ends					
	Y11			-		Progressive shock absorber with reducing sleeve, at both ends					
	N			No cushioning							
Position sensing				Via proximity sensor							
Mounting position				Any							
Max. advancing speed		[m/s]		0.5			0.8				
Max. retracting speed		[m/s]		0.5			0.8				
Repetition accuracy	P1/Y3	[mm]		±0.01							
	P	[mm]		0.3							

Operating and environmental conditions				4	6	8	10	12	16	20	25
Size				4	6	8	10	12	16	20	25
Operating medium				Compressed air to ISO 8573-1:2010 [7:4:4]							
Note on operating/pilot medium				Lubricated operation possible (in which case lubricated operation will always be required)							
Min. operating pressure		[bar]		2.5		1.5		1			
Max. operating pressure ¹⁾		[bar]		8							
Ambient temperature ²⁾		[°C]		0 ... +60							

1) Note max. operating pressure in combination with the intermediate position module DADM-EP → Internet: dadm

2) Note operating range of proximity sensors

Piston Ø, forces and impact energy				4	6	8	10	12	16	20	25
Size				4	6	8	10	12	16	20	25
Piston Ø		[mm]		6	8	10	12	16	20	25	32
Theoretical force at 6 bar, advancing		[N]		17	30	47	68	121	188	295	483
Theoretical force at 6 bar, retracting		[N]		13	23	40	51	104	158	247	415
Impact energy in the end positions	P, E	[Nm]		0.015	0.05	0.08	0.12	0.25	0.35	0.45	0.55
	P1	[Nm]		0.005	0.02	0.03	0.04	0.06	0.12	0.2	0.25
	Y3	[Nm]		-	-	0.8	1.3	2.5	4	8	12
	1)	[Nm]		-	-	-	0.8	1.3	2.5	4	8

1) With reducing sleeve and next smallest shock absorber

Mini slides DGSL

Technical data

FESTO

Weight [g]									
Size	Stroke	4	6	8	10	12	16	20	25
Product weight without cushioning component									
10	82	158	235	396	604	896	1,535	2,520	
20	93	179	263	434	660	954	1,649	2,670	
30	104	197	289	470	711	1,008	1,746	2,824	
40	–	215	313	507	762	1,072	1,857	2,983	
50	–	232	370	548	813	1,143	1,991	3,137	
80	–	–	454	727	1,112	1,365	2,295	4,019	
100	–	–	–	813	1,229	1,712	2,921	4,519	
150	–	–	–	–	1,499	2,034	3,620	5,344	
200	–	–	–	–	–	–	4,248	6,139	
Moving load without cushioning component									
10	31	68	101	163	256	403	660	998	
20	34	76	111	180	279	432	710	1,052	
30	38	83	121	194	299	459	750	1,115	
40	–	90	130	208	320	486	801	1,181	
50	–	99	152	226	340	519	858	1,244	
80	–	–	185	299	456	618	998	1,567	
100	–	–	–	334	507	776	1,254	1,761	
150	–	–	–	–	614	910	1,566	2,102	
200	–	–	–	–	–	–	1,807	2,432	
Cushioning component									
P	2	3.6	6	14	23	45.6	82.4	106	
E	1	2	3	9	12	15	31	40	
P1	1.6	3	5	12	19.7	39.6	77.3	104	
Y3	–	–	6	11	21	42	67	91	
1)	–	–	–	18	33	52	91	131	

1) With reducing sleeve and next smallest shock absorber

Materials

Sectional view

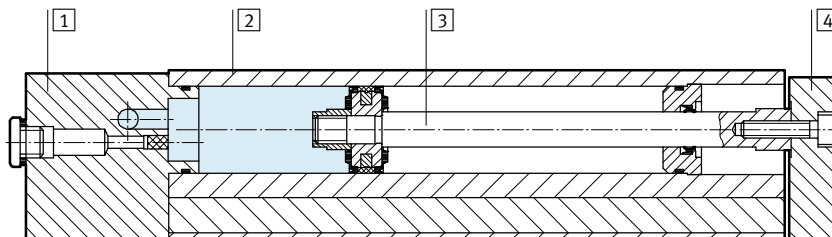

Mini slide		
1	End cap	Anodised aluminum
2	Housing	Anodised aluminum
3	Piston rod	High-alloy steel
4	Yoke plate	Anodised aluminum
–	Guide	Tempered steel
–	Seals	Thermoplastic rubber, hydrogenated nitrile rubber, nitrile rubber
Note on materials		Free of copper and PTFE

Mini slides DGSL

Technical data

Possible combinations without adapter plate

Pick & place

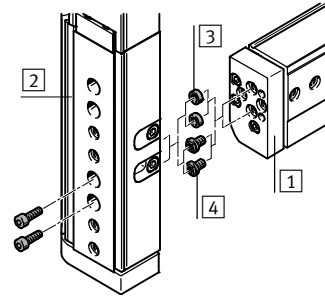
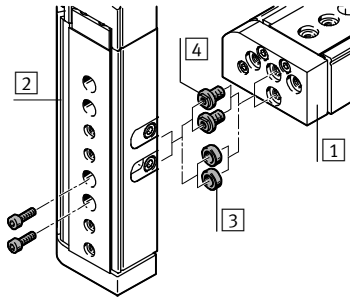

- 3 Centring sleeve ZBH
- 4 Connector sleeve ZBV

Piggy-back assembly

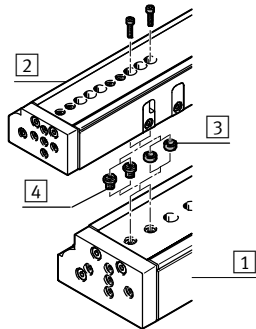

- 3 Centring sleeve ZBH
- 4 Connector sleeve ZBV

Mounting example with connector sleeve ZBV

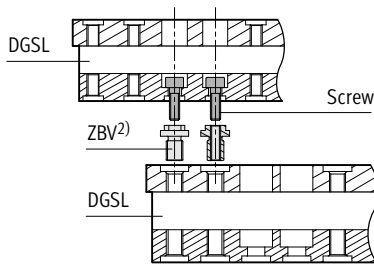

		1 Basic drive								
		Size	4	6	8	10	12	16	20	25
2 Assembly drive	4		2x M3x7 2x ZBH-5 ¹⁾	2x M3x10 2x ZBH-5 ¹⁾	ZBV-M4-7 ²⁾	ZBV-M4-7 ²⁾	-	-	-	-
	6		-	2x M3x10 2x ZBH-5 ¹⁾	ZBV-M4-7 ²⁾	ZBV-M4-7 ²⁾	-	-	-	-
	8		-	-	2x M4x12 2x ZBH-7 ¹⁾	2x M4x12 2x ZBH-7 ¹⁾	ZBV-M5-7 ²⁾	ZBV-M5-7 ²⁾	-	-
	10		-	-	-	2x M4x14 2x ZBH-7 ¹⁾	ZBV-M5-7 ²⁾	ZBV-M5-7 ²⁾	-	-
	12		-	-	-	-	2x M5x14 2x ZBH-7 ¹⁾	2x M5x16 2x ZBH-7 ¹⁾	ZBV-M6-9 ²⁾	ZBV-M6-9 ²⁾
	16		-	-	-	-	-	2x M5x18 2x ZBH-7 ¹⁾	ZBV-M6-9 ²⁾	ZBV-M6-9 ²⁾
	20		-	-	-	-	-	-	2x M6x20 2x ZBH-9 ¹⁾	2x M6x20 2x ZBH-9 ¹⁾
	25		-	-	-	-	-	-	-	2x M6x30 2x ZBH-9 ¹⁾

1) Centring sleeves ZBH are included in the scope of delivery of the mini slide DGSL

2) Connector sleeves ZBV → 50

Mini slides DGSL

Technical data

Parallelism [mm]

The term parallelism refers to the accuracy of alignment between the mounting surface and the slide surface.

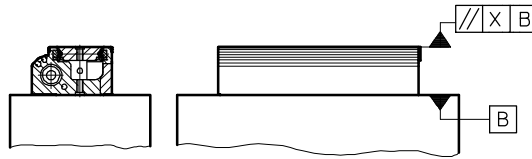

Size	Stroke [mm]	4	6	8	10	12	16	20	25
Parallelism X	10	0.02	0.02	0.02	0.02	0.02	0.02	0.02	0.02
	20	0.02	0.02	0.02	0.02	0.025	0.025	0.025	0.025
	30	0.025	0.025	0.025	0.025	0.025	0.025	0.025	0.03
	40	-	0.025	0.025	0.025	0.025	0.03	0.03	0.035
	50	-	0.03	0.03	0.03	0.03	0.035	0.035	0.04
	80	-	-	0.035	0.035	0.035	0.04	0.04	0.045
	100	-	-	-	0.045	0.045	0.05	0.05	0.055
	150	-	-	-	-	0.075	0.075	0.075	0.08
200	-	-	-	-	-	-	0.08	0.08	

Linearity [mm]

The term linearity refers to the accuracy of alignment between the mounting surface and the slide surface as a function of the stroke.

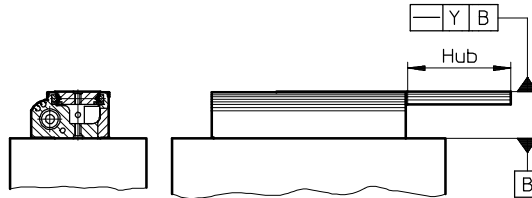

Linear travel accuracy y as a function of stroke length l

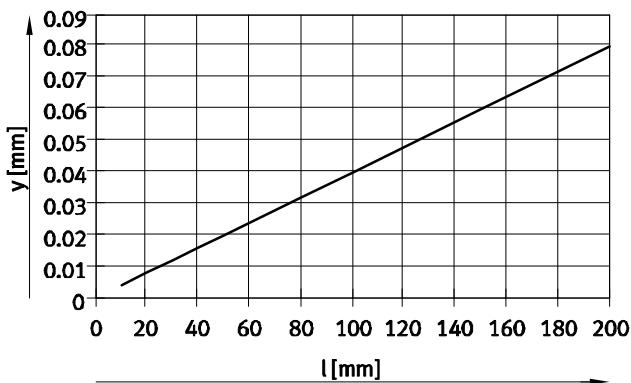

Mini slides DGSL

Technical data

Adjustable end-position range

Coarse adjustment of the advanced end position

The mini slide DGSL allows the advanced fixed stop to be adjusted by removing the cover. This permits stroke reduction down to

the next but one smaller standard stroke through a combination of coarse and precision adjustments.

Advantages:

- Can be flexibly adapted to the application
- Integrated, which means reduced conversion effort and costs
- Large setting range



Note

Removal of the fixed stops can severely damage the mini slide DGSL.

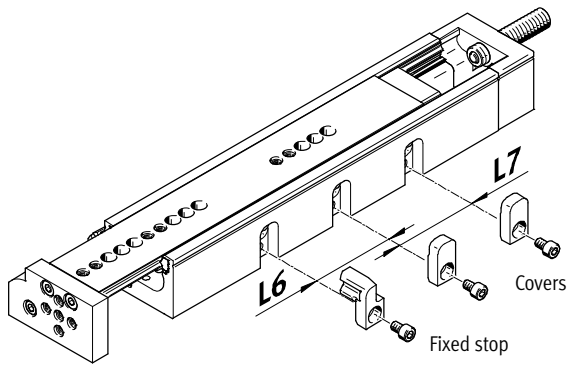

Size Stroke [mm]	4		6		8		10		12		16		20		25	
	L6	L7	L6	L7	L6	L7	L6	L7	L6	L7	L6	L7	L6	L7	L6	L7
10	-	-	-	-	-	-	-	-	-	-	-	-	-	-	-	-
20	10	-	14	-	10	-	-	-	-	-	-	-	-	-	-	-
30	10	-	14	-	16	-	-	-	-	-	-	-	-	-	-	-
40	-	-	14	-	16	-	-	-	-	-	-	-	-	-	-	-
50	-	-	14	14	16	-	-	-	-	-	-	-	-	-	-	-
80	-	-	-	-	16	16	24	-	29	-	35	-	-	-	55	-
100	-	-	-	-	-	-	24	24	29	-	35	-	44	-	55	-
150	-	-	-	-	-	-	-	-	29	29	35	-	44	-	55	-
200	-	-	-	-	-	-	-	-	-	-	-	-	44	44	55	-

Example:

DGSL-12-150-...

Max. stroke = 150 mm

By adjusting the fixed stop by the dimension L6:

$$\text{Stroke} = 150 - 29 = 121 \text{ mm}$$

By adjusting the fixed stop by the dimension L6 and L7:

$$\text{Stroke} = 150 - 29 - 29 = 92 \text{ mm}$$

The stroke can also be reduced through a precision adjustment:

$$\text{Stroke} = 150 - 29 - 29 - 29 = 63 \text{ mm}$$

Precision adjustment of the advanced and retracted end position

→ 11

Mini slides DGSL

Technical data

Adjustable end-position range

Precision adjustment of the advanced and retracted end position

Precision adjustment of the required stroke reduction is possible using the cushioning components (on the slide and in the end cap).

Advantages:

- Precision adjustment is accurately fixed by the clamping component
- No readjustment required, position is fully retained under lock and load
- Quick and easy adjustment, only one tool required

Step 1:

Loosen the clamping component.

Step 2:

Position the slide by hand in the required end position.

Step 3:

Turn the stop element using an Allen key until the end position is reached.

Step 4:

Tighten the clamping component.

Step 1

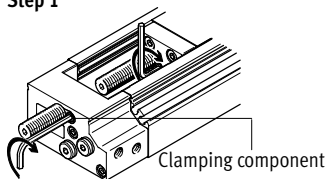

Step 2 ... 4

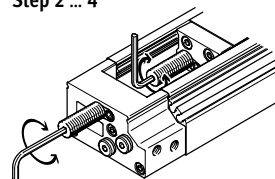

Adjustable end-position range [mm] per end position/stroke reduction									
Size		4	6	8	10	12	16	20	25
Advanced end position									
With cushioning	P	-14.5	-16.5	-19.5	-27.5	-29	-37.5	-50.5	-55
	E	-4.5	-5	-4.5	-13	-9	-3.5	-6.5	-11.5
	P1	-14.5	-16.5	-19.5	-27.5	-29	-37.5	-50.5	-55
	Y3	-	-	-15	-24	-29	-36.5	-44	-56
	1)	-	-	-	-24	-29	-36.5	-44	-56
Retracted end position									
With cushioning	P	-13.5	-15	-18.5	-20	-25.5	-39.5	-49.5	-49
	E	-3.5	-3.5	-3.5	-5.5	-5.5	-5.5	-5.5	-5.5
	P1	-13.5	-15	-18.5	-20	-25.5	-39.5	-49.5	-49
	Y3	-	-	-14	-15	-25.5	-38.5	-42	-51.5
	1)	-	-	-	-15	-25.5	-38.5	-42	-51.5

1) With reducing sleeve and next smallest shock absorber

Note

The distance L of the cushioning component (→ operating instructions) must not be fallen below (factory setting).

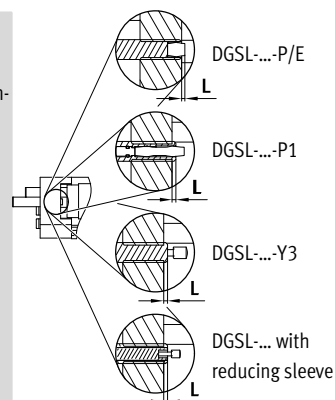

Note

The setting range of the advanced and retracted end position is restricted when using the cushioning type "E".

Mini slides DGSL

Technical data

Shock absorber selection

Payload load m as a function of impact velocity v

With the mini slide DGSL the shock absorber can be replaced and the cushioning behaviour can thus be influenced (depending on the payload).

This is done by removing the existing shock absorbers on the DGSL and replacing them with a smaller shock absorber as appropriate to the application (→ description below).

Graphs

for selecting a suitable shock absorber as a function of the mounting position of the mini slide → from 13.

Ordering data

Shock absorbers DYSW, DYEF and reducing sleeve DAYH → 49.

With smaller loads:

The next smallest shock absorber DYSW can be installed with the help of the reducing sleeve DAYH.

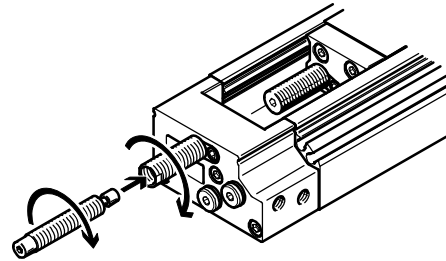
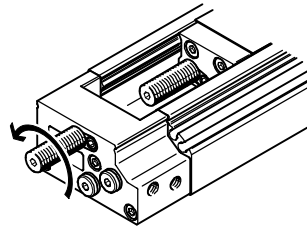

With very small loads:

The shock absorber DYEF can be installed.

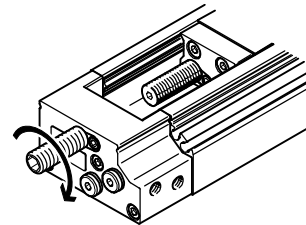
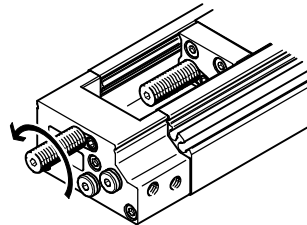

Selection example:

Current drive:

Mini slide: DGSL-10-...-Y3-A

Given:

Payload: 500 g

Impact velocity: 0.4 m/s

Mounting position: Horizontal

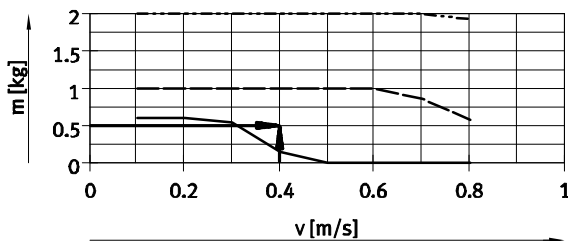

- DYSW-5-8 (cushioning Y3)
- DYSW-4-6 with DAYH-4 (cushioning Y11)
- DYEF-M8-Y1F

Result:

The first cushioning curve, which is located above the point of intersection, is the most suitable in this case. Due to the low payload of less than one kilogram, the cushioning characteristics are greatly improved by

replacing the shock absorber DYSW-5-8 integrated in the mini slide with the reducing sleeve DAYH-4 and the next smallest shock absorber DYSW-4-6.

Fundamentally, the following applies: shock absorbers must be loaded. Since the shock absorber DYSW-4-6 is more fully utilised in this case, both

the service life of the shock absorber and the cushioning characteristics are improved.

Mini slides DGSL

Technical data

FESTO

Shock absorber selection

Payload m as a function of impact velocity v – horizontal mounting position

DGSL-4

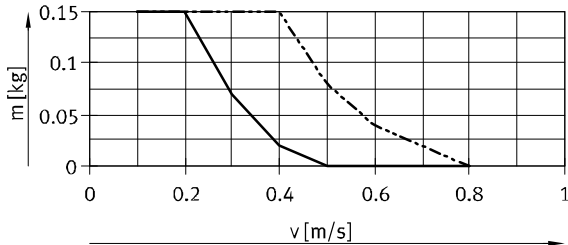

- DYEF-M4-Y1F (cushioning P1)
- - - DYEF-M4-Y1 (cushioning P)

DGSL-6

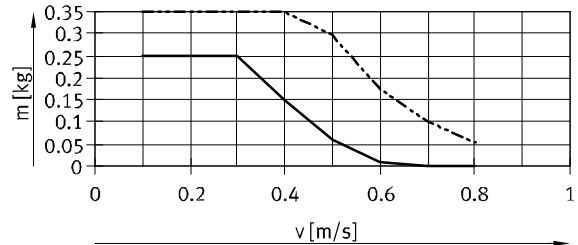

- DYEF-M5-Y1F (cushioning P1)
- - - DYEF-M5-Y1 (cushioning P)

DGSL-8

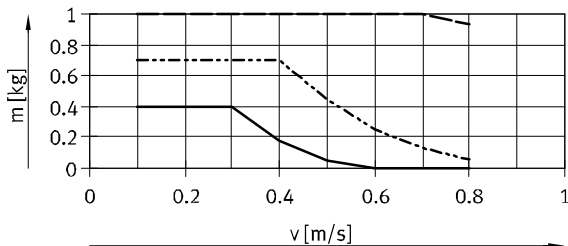

- DYEF-M6-Y1F (cushioning P1)
- - - DYEF-M6-Y1 (cushioning P)
- · - DYSW-4-6 (cushioning Y3)

DGSL-10

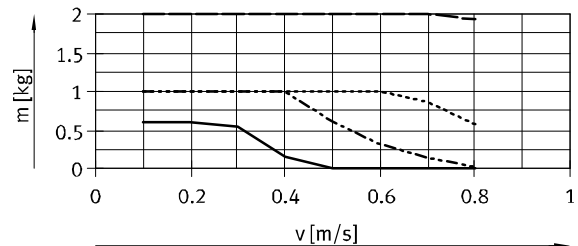

- DYEF-M8-Y1F (cushioning P1)
- - - DYEF-M8-Y1 (cushioning P)
- · - DYSW-5-8 (cushioning Y3)
- · · DYSW-4-6 with DAYH-4 (cushioning Y11)

DGSL-12

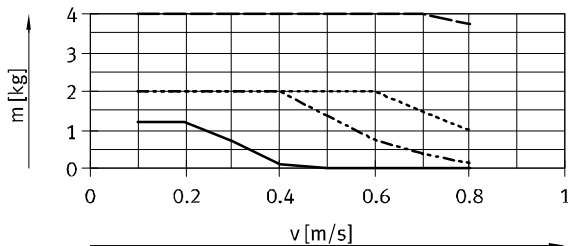

- DYEF-M10-Y1F (cushioning P1)
- - - DYEF-M10-Y1 (cushioning P)
- · - DYSW-7-10 (cushioning Y3)
- · · DYSW-5-8 with DAYH-5 (cushioning Y11)

DGSL-16

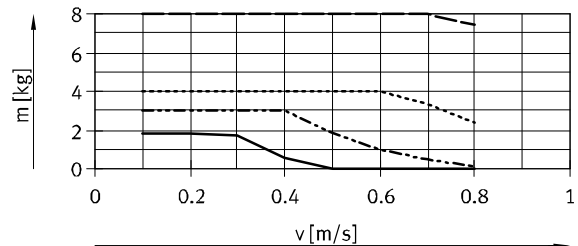

- DYEF-M12-Y1F (cushioning P1)
- - - DYEF-M12-Y1 (cushioning P)
- · - DYSW-8-14 (cushioning Y3)
- · · DYSW-7-10 with DAYH-7 (cushioning Y11)

DGSL-20

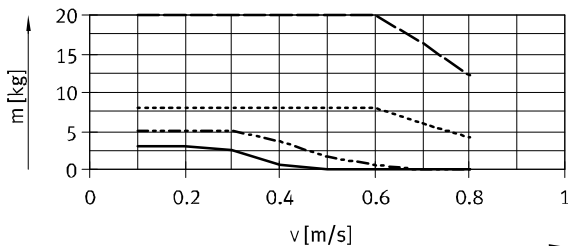

- DYEF-M14-Y1F (cushioning P1)
- - - DYEF-M14-Y1 (cushioning P)
- · - DYSW-10-17 (cushioning Y3)
- · · DYSW-8-14 with DAYH-8 (cushioning Y11)

DGSL-25

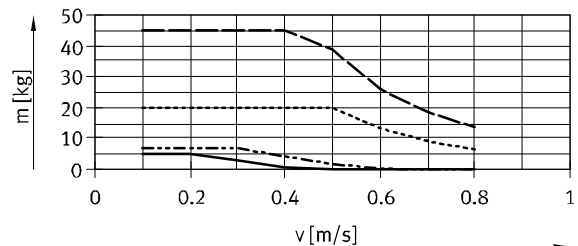

- DYEF-M16-Y1F (cushioning P1)
- - - DYEF-M16-Y1 (cushioning P)
- · - DYSW-12-20 (cushioning Y3)
- · · DYSW-10-17 with DAYH-10 (cushioning Y11)

Mini slides DGSL

Technical data

FESTO

Shock absorber selection

Payload m as a function of impact velocity v – vertical mounting position, payload moving upwards

DGSL-4

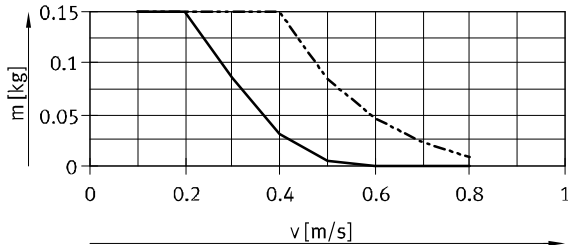

— DYEF-M4-Y1F (cushioning P1)
 - - - DYEF-M4-Y1 (cushioning P)

DGSL-6

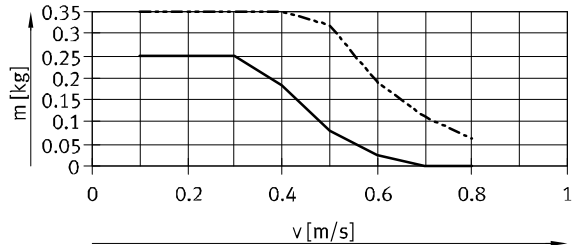

— DYEF-M5-Y1F (cushioning P1)
 - - - DYEF-M5-Y1 (cushioning P)

DGSL-8

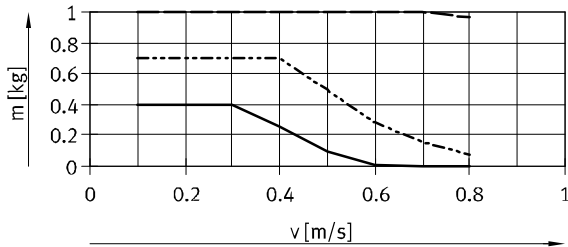

— DYEF-M6-Y1F (cushioning P1)
 - - - DYEF-M6-Y1 (cushioning P)
 - · - DYSW-4-6 (cushioning Y3)

DGSL-10

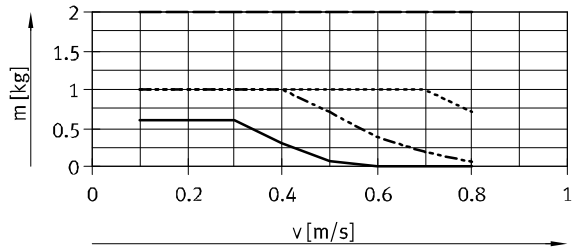

— DYEF-M8-Y1F (cushioning P1)
 - - - DYEF-M8-Y1 (cushioning P)
 - · - DYSW-5-8 (cushioning Y3)
 ····· DYSW-4-6 with DAYH-4 (cushioning Y11)

DGSL-12

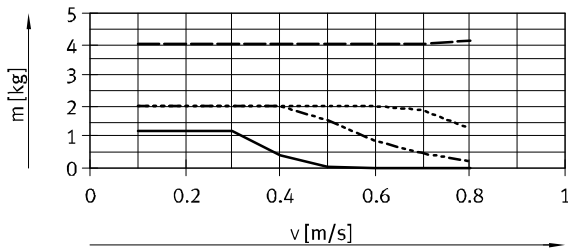

— DYEF-M10-Y1F (cushioning P1)
 - - - DYEF-M10-Y1 (cushioning P)
 - · - DYSW-7-10 (cushioning Y3)
 ····· DYSW-5-8 with DAYH-5 (cushioning Y11)

DGSL-16

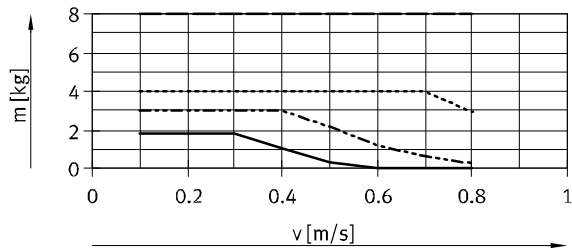

— DYEF-M12-Y1F (cushioning P1)
 - - - DYEF-M12-Y1 (cushioning P)
 - · - DYSW-8-14 (cushioning Y3)
 ····· DYSW-7-10 with DAYH-7 (cushioning Y11)

DGSL-20

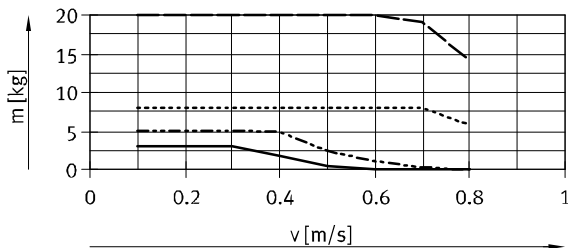

— DYEF-M14-Y1F (cushioning P1)
 - - - DYEF-M14-Y1 (cushioning P)
 - · - DYSW-10-17 (cushioning Y3)
 ····· DYSW-8-14 with DAYH-8 (cushioning Y11)

DGSL-25

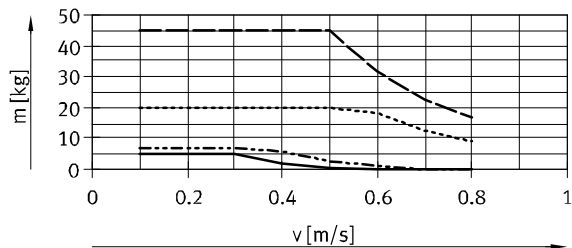

— DYEF-M16-Y1F (cushioning P1)
 - - - DYEF-M16-Y1 (cushioning P)
 - · - DYSW-12-20 (cushioning Y3)
 ····· DYSW-10-17 with DAYH-10 (cushioning Y11)

Mini slides DGSL

Technical data

Shock absorber selection

Payload m as a function of impact velocity v – vertical mounting position, payload moving downwards

DGSL-4

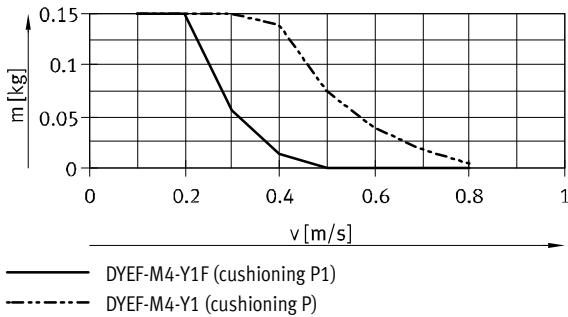

DGSL-6

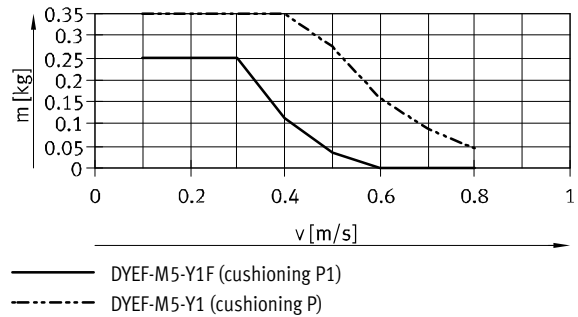

DGSL-8

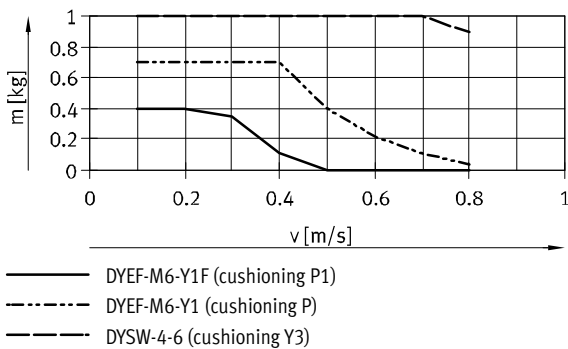

DGSL-10

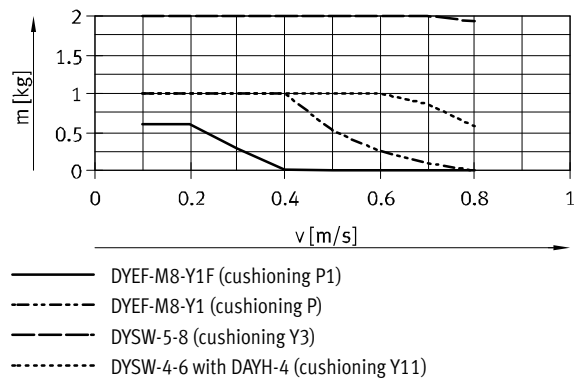

DGSL-12

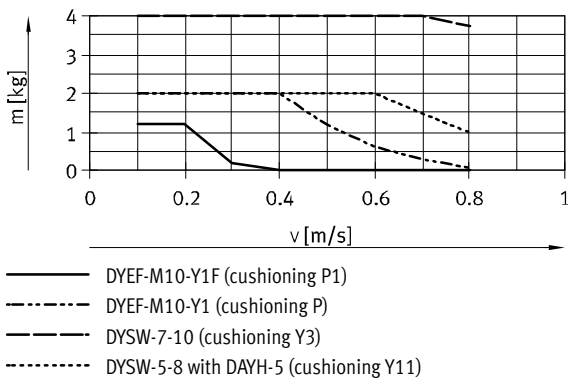

DGSL-16

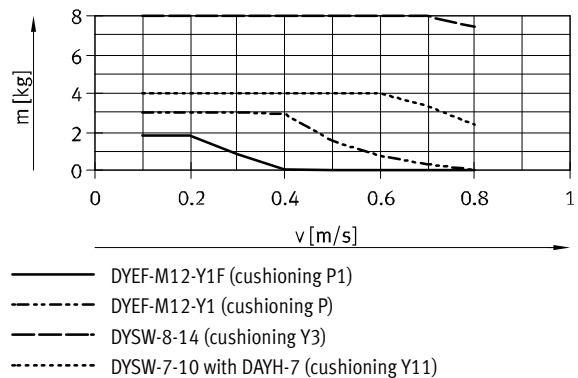

DGSL-20

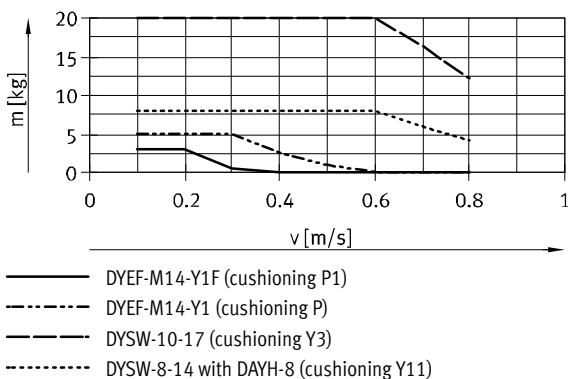

DGSL-25

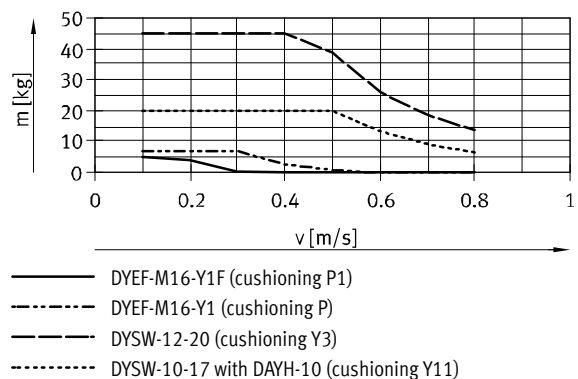

Mini slides DGSL

Technical data

Shock absorber selection

Travel time t as a function of payload m and cushioning P/E – horizontal mounting position



The values in the graphs are determined by calculation. The travel time as a function of payload must not be reduced below the

values shown, because the kinetic impact or residual energy in the end positions can result in damage to the drive.

Vertical mounting position
→ 19

Advancing

Stroke 10 mm, size 4 ... 10

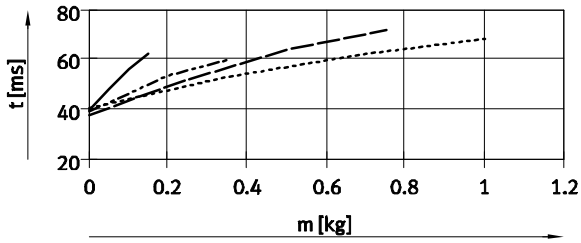

Retracting

Stroke 10 mm, size 4 ... 10

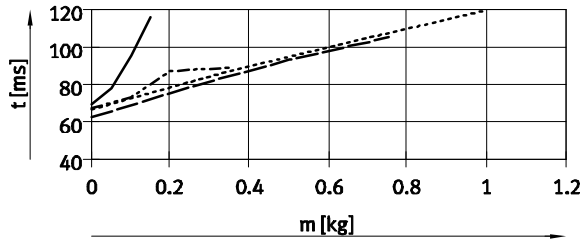

Stroke 10 mm, size 12 ... 16

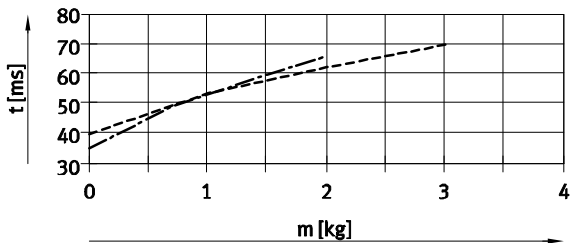

Stroke 10 mm, size 12 ... 16

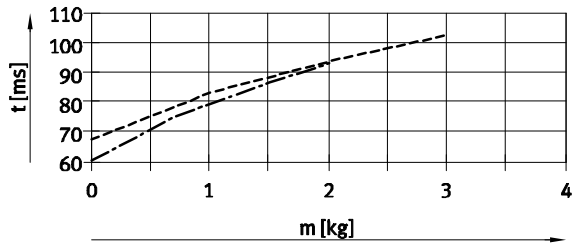

Stroke 10 mm, size 20 ... 25

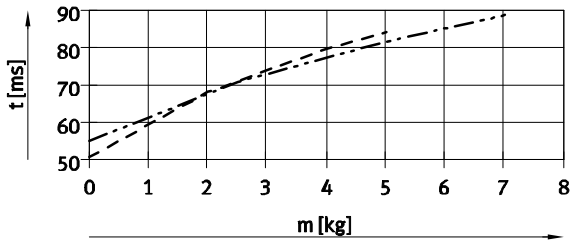

Stroke 10 mm, size 20 ... 25

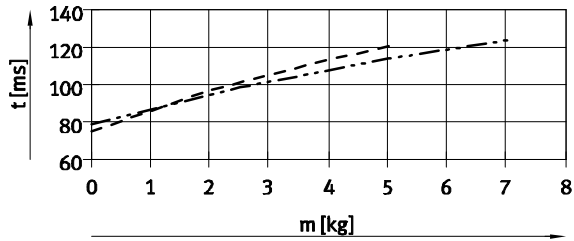

Stroke 30 mm, size 4 ... 10

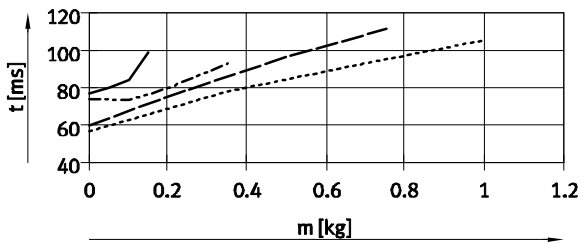

Stroke 30 mm, size 4 ... 10

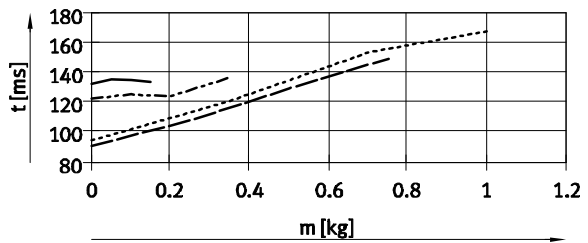

- | | |
|---------------|---------------|
| ————— DGSL-4 | ----- DGSL-12 |
| ----- DGSL-6 | ----- DGSL-16 |
| ----- DGSL-8 | ----- DGSL-20 |
| ----- DGSL-10 | ----- DGSL-25 |

Mini slides DGSL

Technical data

Shock absorber selection

Travel time t as a function of payload m and cushioning P/E – horizontal mounting position



The values in the graphs are determined by calculation. The travel time as a function of payload must not be reduced below the

values shown, because the kinetic impact or residual energy in the end positions can result in damage to the drive.

Vertical mounting position → 19

Advancing

Stroke 30 mm, size 12 ... 25

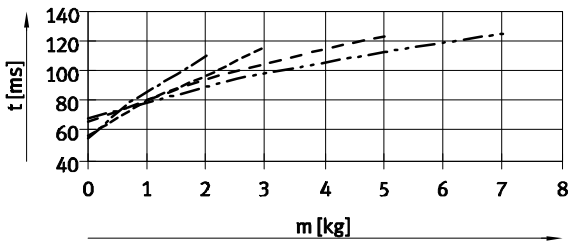

Retracting

Stroke 30 mm, size 12 ... 16

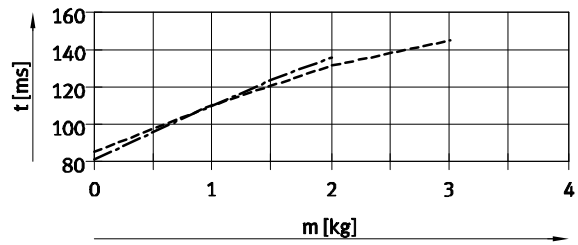

Stroke 30 mm, size 20 ... 25

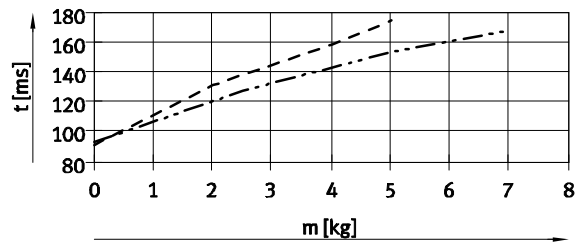

Stroke 50 mm, size 6 ... 12

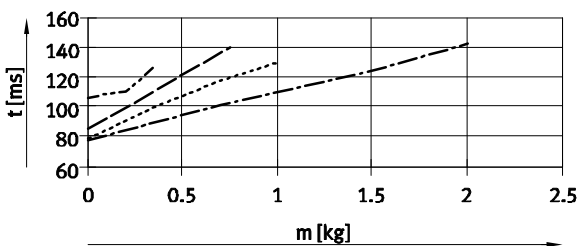

Stroke 50 mm, size 6 ... 12

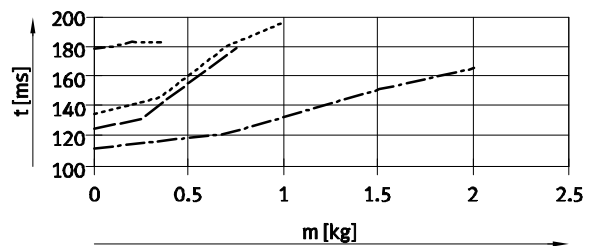

Stroke 50 mm, size 16 ... 25

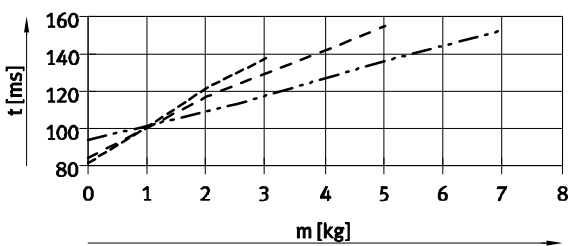

Stroke 50 mm, size 16

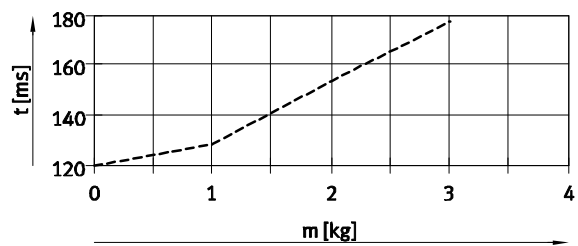

- DGSL-6
- DGSL-8
- DGSL-10
- DGSL-12
- DGSL-16
- DGSL-20
- DGSL-25

Stroke 50 mm, size 20 ... 25

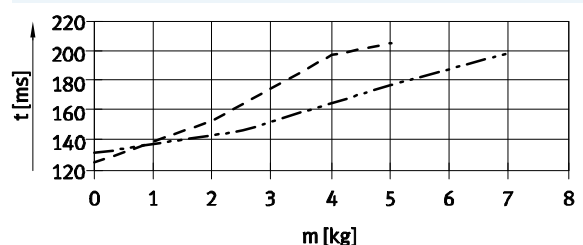

Mini slides DGSL

Technical data

Shock absorber selection

Travel time t as a function of payload m and cushioning P/E – horizontal mounting position



The values in the graphs are determined by calculation. The travel time as a function of payload must not be reduced below the

values shown, because the kinetic impact or residual energy in the end positions can result in damage to the drive.

Vertical mounting position → 19

Advancing

Stroke 100 mm, size 10 ... 16

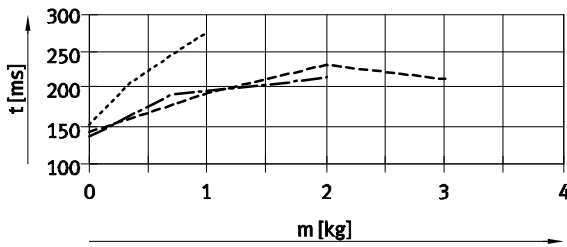

Retracting

Stroke 100 mm, size 10 ... 16

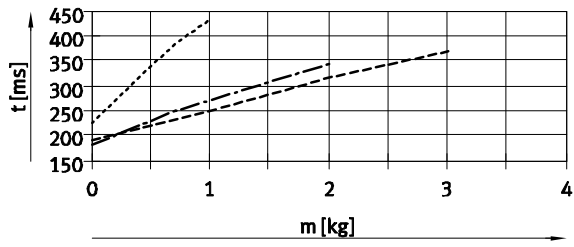

Stroke 100 mm, size 20 ... 25

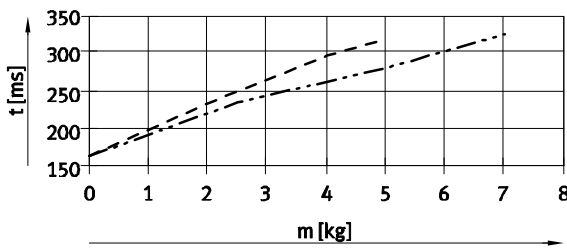

Stroke 100 mm, size 20 ... 25

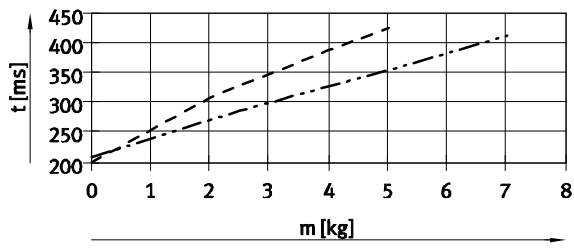

Stroke 150 mm, size 12 ... 16

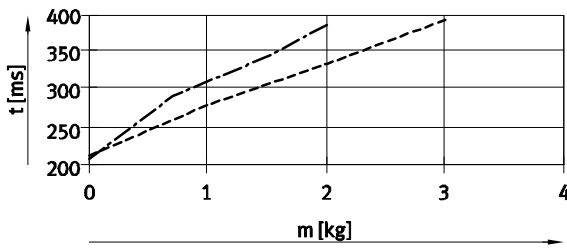

Stroke 150 mm, size 12 ... 16

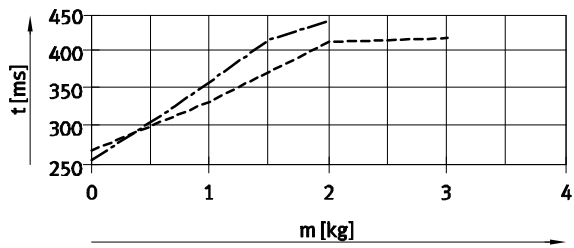

Stroke 150 mm, size 20 ... 25

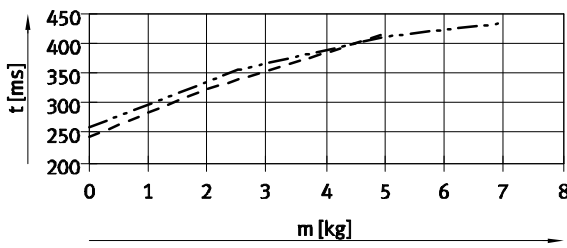

Stroke 150 mm, size 20 ... 25

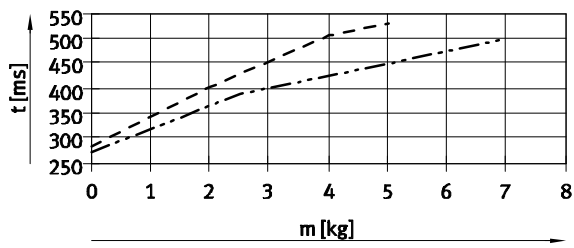

- DGSL-10
- · - · - DGSL-12
- DGSL-16
- DGSL-20
- DGSL-25

Mini slides DGSL

Technical data

Shock absorber selection

Travel time t as a function of payload m and cushioning P/E – horizontal mounting position



The values in the graphs are determined by calculation. The travel time as a function of payload must not be reduced below the

values shown, because the kinetic impact or residual energy in the end positions can result in damage to the drive.

Vertical mounting position
→ 19

Advancing

Stroke 200 mm, size 20 ... 25

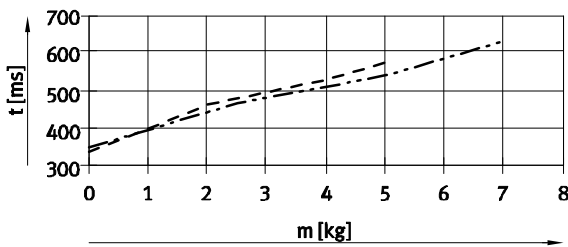

Retracting

Stroke 200 mm, size 20 ... 25

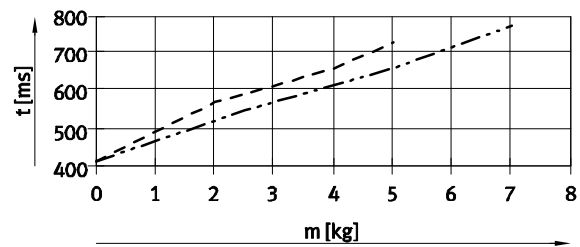

- - - - DGSL-20
- . - . - DGSL-25

Vertical mounting position

The travel times for a vertical mounting position are calculated by multiplying the data for a horizontal mounting position by a correction factor k_a (advancing) and k_r (retracting), see adjacent table.

Given:
 Stroke = 200 mm
 Size = 20
 Payload = 3 kg
 Ascertained travel time t_h (horizontal), see graph:
 – Advancing = 500 ms
 – Retracting = 600 ms
 Calculated travel time t_v (vertical):
 – Advancing: $t_v = t_h \times k_a$
 $t_v = 500 \text{ ms} \times 0.9 = 450 \text{ ms}$
 – Retracting: $t_v = t_h \times k_r$
 $t_v = 600 \text{ ms} \times 1.1 = 660 \text{ ms}$

Stroke [mm]	Size	Advancing (k_a) ¹⁾	Retracting (k_r)
10	4, 6, 8, 10	0.95	1.1
	12, 16, 20, 25	0.95	1.2
30	4, 6, 8, 10	0.95	1.1
	12, 16, 20, 25	0.95	1.2
50	6, 8, 10, 12	0.9	1.1
	16, 20, 25	1.1	1.2
100	10, 12, 16, 20, 25	1	1.1
150	12, 16, 20, 25	1	1.1
200	20, 25	0.9	1.1

1) Downward

Mini slides DGSL

Technical data



Shock absorber selection

Travel time t as a function of payload m and cushioning P1 – horizontal mounting position



The values in the graphs are determined by calculation. The travel time as a function of payload must not be reduced below the

values shown, because the kinetic impact or residual energy in the end positions can result in damage to the drive.

Vertical mounting position
→ 23

Advancing

Stroke 10 mm, size 4 ... 10

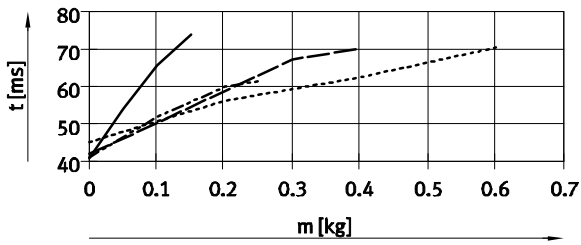

Retracting

Stroke 10 mm, size 4 ... 10

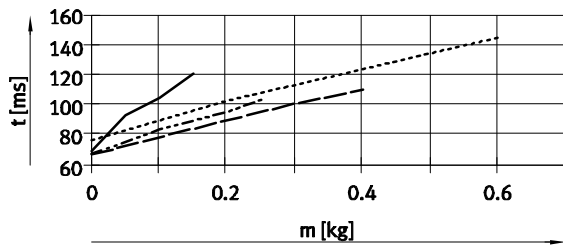

Stroke 10 mm, size 12 ... 16

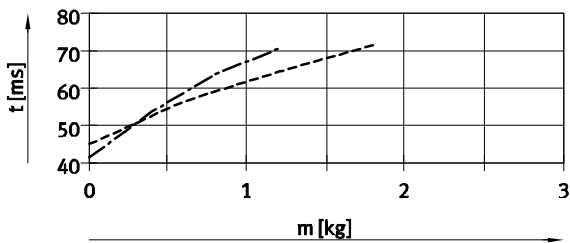

Stroke 10 mm, size 12 ... 16

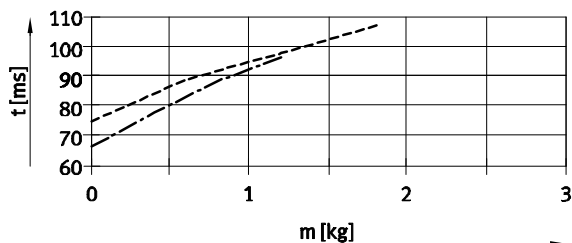

Stroke 10 mm, size 20 ... 25

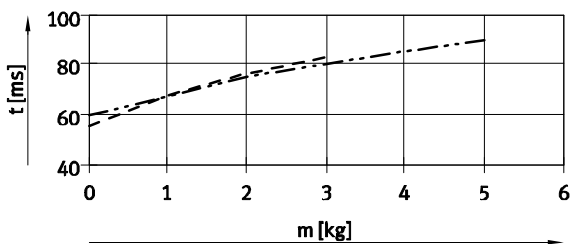

Stroke 10 mm, size 20 ... 25

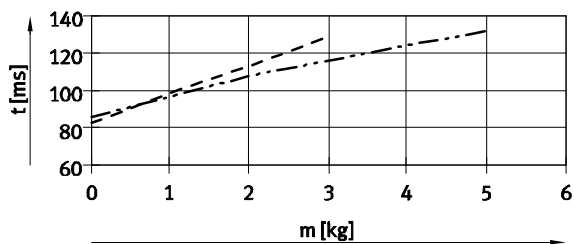

Stroke 30 mm, size 4 ... 10

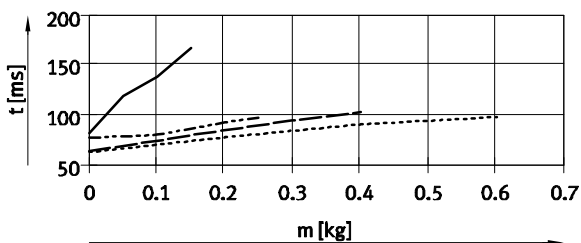

Stroke 30 mm, size 4 ... 10

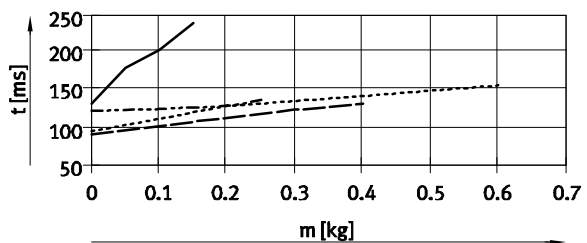

- | | |
|---------------|---------------|
| ————— DGSL-4 | ----- DGSL-12 |
| ----- DGSL-6 | ----- DGSL-16 |
| ----- DGSL-8 | ----- DGSL-20 |
| ----- DGSL-10 | ----- DGSL-25 |

Mini slides DGSL

Technical data

Shock absorber selection

Travel time t as a function of payload m and cushioning P1 – horizontal mounting position



The values in the graphs are determined by calculation. The travel time as a function of payload must not be reduced below the

values shown, because the kinetic impact or residual energy in the end positions can result in damage to the drive.

Vertical mounting position → 23

Advancing

Stroke 30 mm, size 12 ... 16

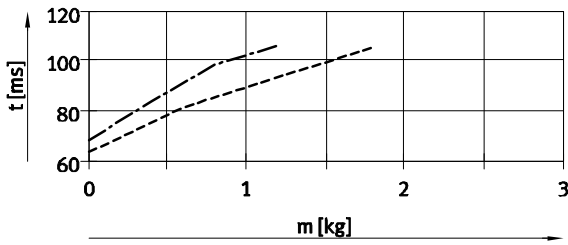

Retracting

Stroke 30 mm, size 12 ... 16

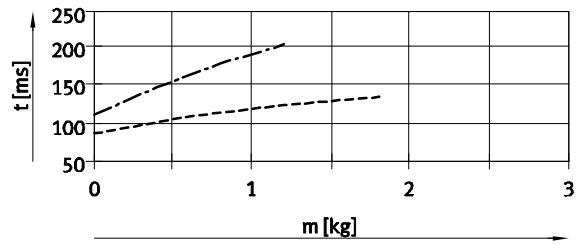

Stroke 30 mm, size 20 ... 25

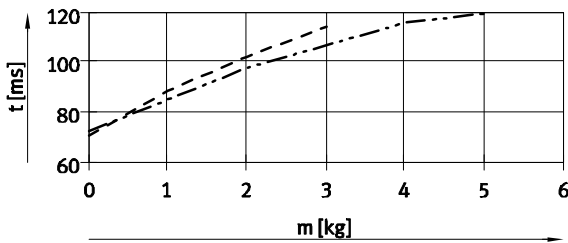

Stroke 30 mm, size 20 ... 25

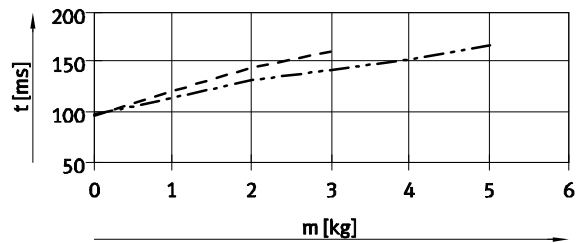

Stroke 50 mm, size 6 ... 12

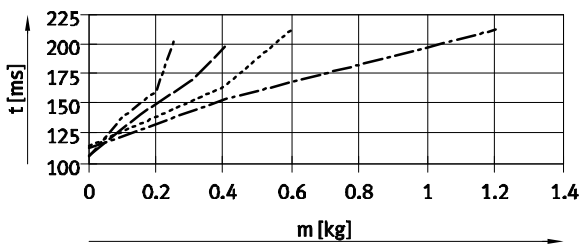

Stroke 50 mm, size 6 ... 12

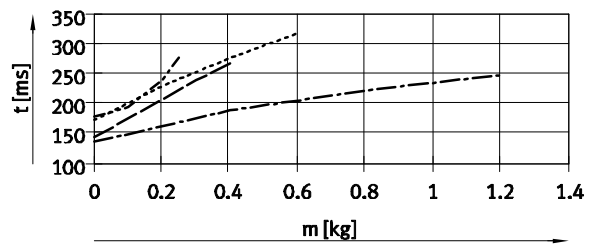

Stroke 50 mm, size 16 ... 25

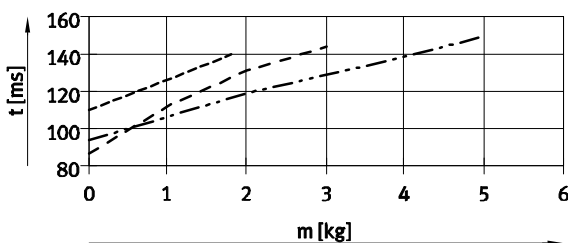

Stroke 50 mm, size 16 ... 25

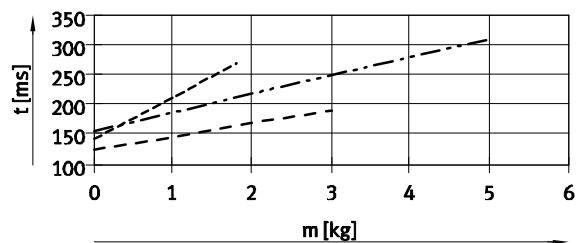

- DGSL-6
- DGSL-8
- DGSL-10
- DGSL-12
- DGSL-16
- DGSL-20
- DGSL-25

Mini slides DGSL

Technical data

Shock absorber selection

Travel time t as a function of payload m and cushioning P1 – horizontal mounting position



The values in the graphs are determined by calculation. The travel time as a function of payload must not be reduced below the

values shown, because the kinetic impact or residual energy in the end positions can result in damage to the drive.

Vertical mounting position
→ 23

Advancing

Stroke 100 mm, size 10 ... 16

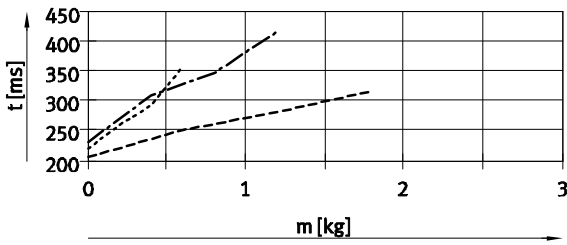

Retracting

Stroke 100 mm, size 10 ... 25

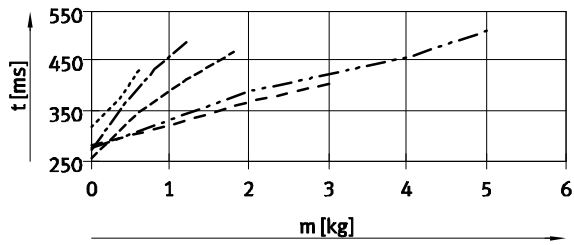

Stroke 100 mm, size 20 ... 25

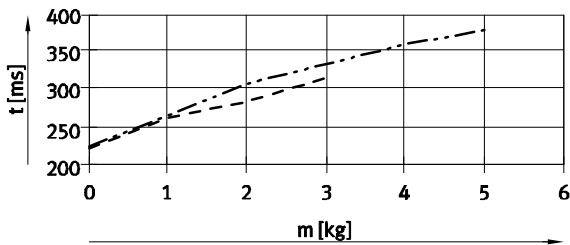

Stroke 150 mm, size 12 ... 25

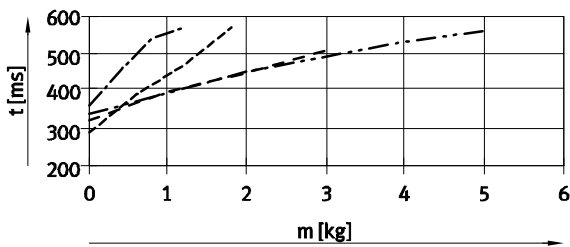

Stroke 150 mm, size 12 ... 25

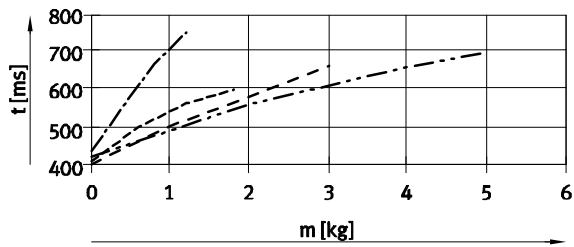

- DGSL-10
- · - · - DGSL-12
- DGSL-16
- DGSL-20
- · - · - DGSL-25

Mini slides DGSL

Technical data

Shock absorber selection

Travel time t as a function of payload m and cushioning P1 – horizontal mounting position

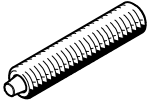

The values in the graphs are determined by calculation. The travel time as a function of payload must not be reduced below the

values shown, because the kinetic impact or residual energy in the end positions can result in damage to the drive.

Vertical mounting position → 23

Advancing

Stroke 200 mm, size 20

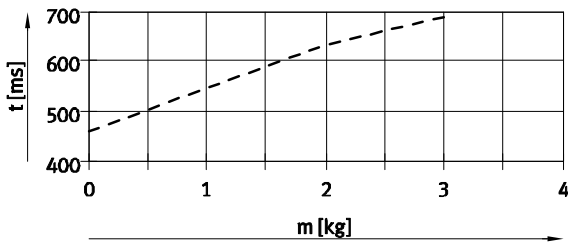

Retracting

Stroke 200 mm, size 20

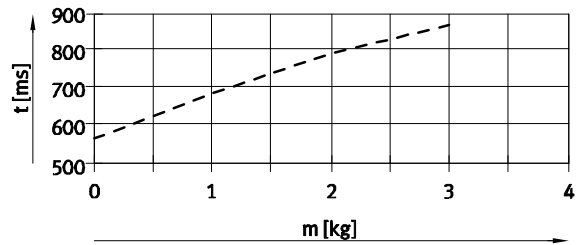

Stroke 200 mm, size 25

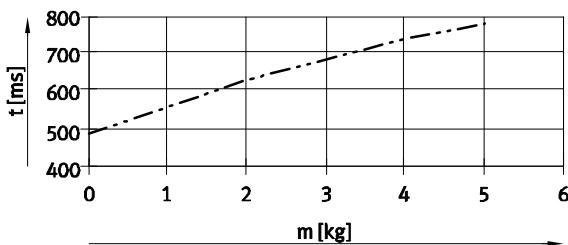

Stroke 200 mm, size 25

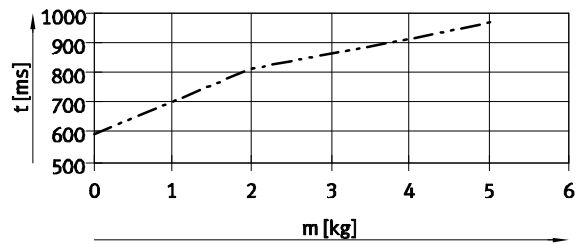

- DGSL-20
- - - DGSL-25

Vertical mounting position

The travel times for a vertical mounting position are calculated by multiplying the data for a horizontal mounting position by a correction factor k_a (advancing) and k_r (retracting), see adjacent table.

Given:
 Stroke = 200 mm
 Size = 20
 Payload = 2 kg
 Ascertained travel time t_h (horizontal), see graph:
 – Advancing = 640 ms
 – Retracting = 780 ms
 Calculated travel time t_v (vertical):
 – Advancing: $t_v = t_h \times k_a$
 $t_v = 640 \text{ ms} \times 0.9 = 576 \text{ ms}$
 – Retracting: $t_v = t_h \times k_r$
 $t_v = 780 \text{ ms} \times 1.1 = 858 \text{ ms}$

Stroke [mm]	Size	Advancing (k_a) ¹⁾	Retracting (k_r)
10	4, 6, 8, 10	1	1.1
	12, 16, 20, 25	1.1	1.2
30	4, 6, 8, 10	1	1.1
	12, 16, 20, 25	1.1	1.2
50	6, 8, 10, 12	1	1.1
	16, 20, 25	0.9	1.1
100	10, 12, 16, 20, 25	0.95	1.1
150	12, 16, 20, 25	0.95	1.1
200	20, 25	0.9	1.1

1) Downward

Mini slides DGSL

Technical data

FESTO

Shock absorber selection

Travel time t as a function of payload m and cushioning Y3 – horizontal mounting position

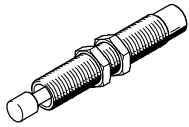

The values in the graphs are determined by calculation. The travel time as a function of payload must not be reduced below the

values shown, because the kinetic impact or residual energy in the end positions can result in damage to the drive.

Vertical mounting position
→ 25

Advancing

Stroke 30 mm, size 8 ... 12

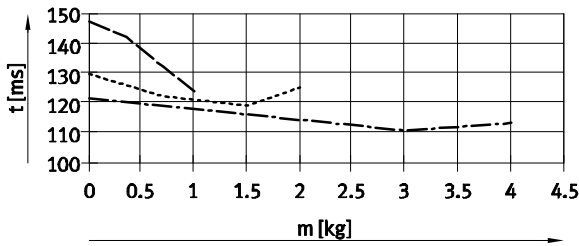

Retracting

Stroke 30 mm, size 8 ... 12

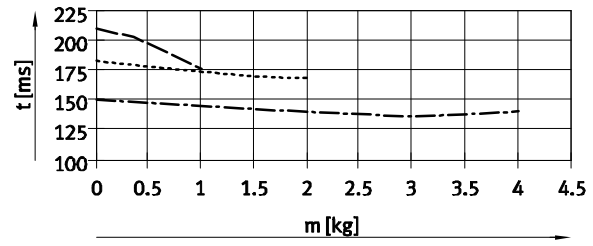

Stroke 30 mm, size 16 ... 25

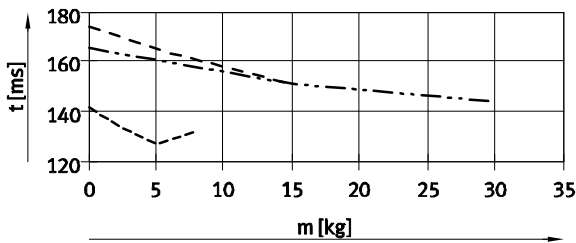

Stroke 30 mm, size 16 ... 25

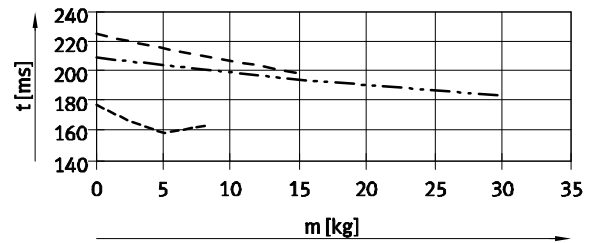

Stroke 50 mm, size 8 ... 12

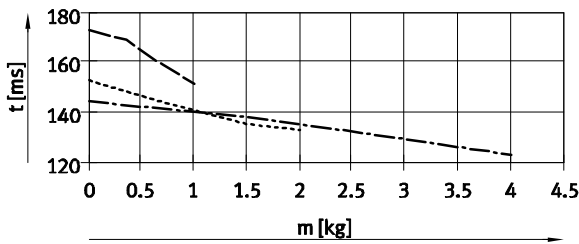

Stroke 50 mm, size 8 ... 12

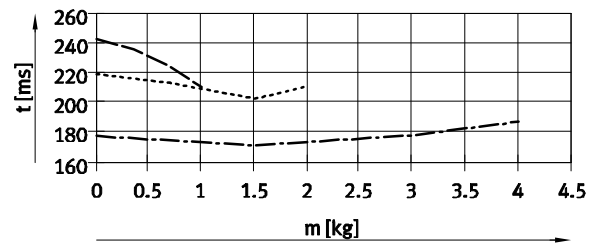

Stroke 50 mm, size 16 ... 25

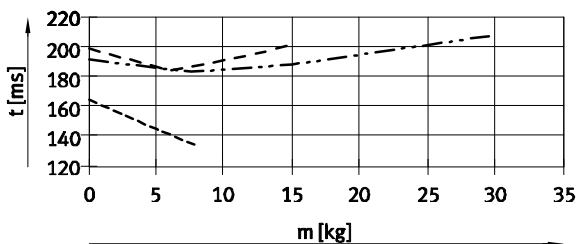

Stroke 50 mm, size 16 ... 25

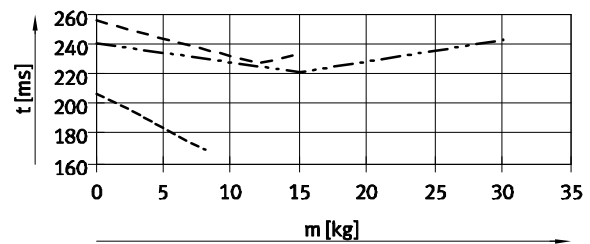

- DGSL-8
- DGSL-10
- · - DGSL-12
- DGSL-16
- DGSL-20
- · - DGSL-25

Mini slides DGSL

Technical data

Shock absorber selection

Travel time t as a function of payload m and cushioning Y3 – horizontal mounting position

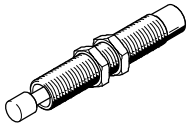

The values in the graphs are determined by calculation. The travel time as a function of payload must not be reduced below the

values shown, because the kinetic impact or residual energy in the end positions can result in damage to the drive.

Vertical mounting position
→ 25

Advancing

Stroke 100 mm, size 10 ... 25

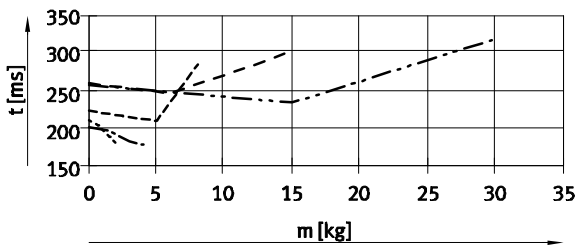

Retracting

Stroke 100 mm, size 10 ... 25

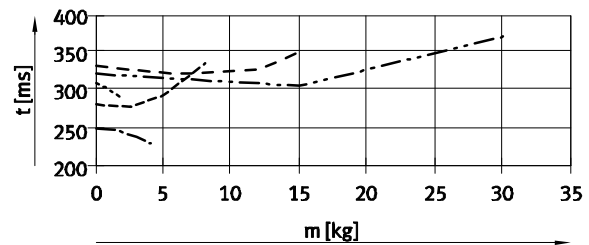

Stroke 150 mm, size 12 ... 25

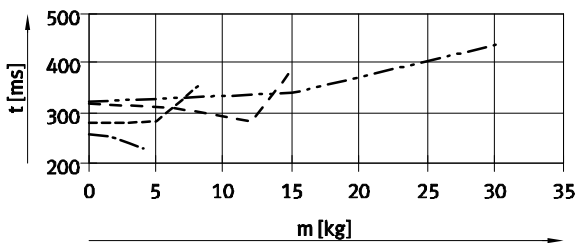

Stroke 150 mm, size 12 ... 25

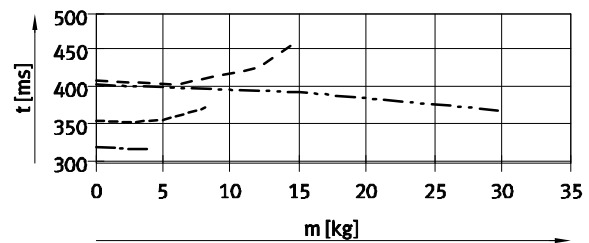

Stroke 200 mm, size 20 ... 25

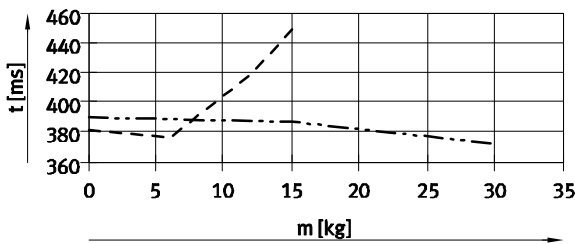

Stroke 200 mm, size 20 ... 25

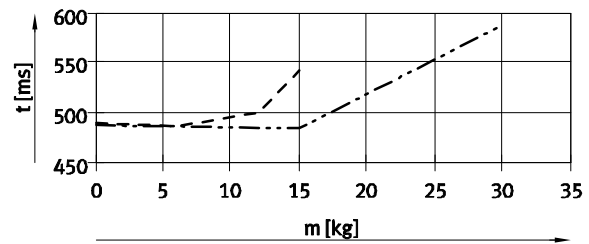

- DGSL-10
- DGSL-12
- DGSL-16
- DGSL-20
- DGSL-25

Vertical mounting position

The travel times for a vertical mounting position are calculated by multiplying the data for a horizontal mounting position by a correction factor k_a (advancing) and k_r (retracting), see adjacent table.

Given:
 Stroke = 200 mm
 Size = 20
 Payload = 10 kg
 Ascertained travel time t_h (horizontal), see graph:
 – Advancing = 405 ms
 – Retracting = 490 ms
 Calculated travel time t_v (vertical):
 – Advancing: $t_v = t_h \times k_a$
 $t_v = 405 \text{ ms} \times 0.9 = 365 \text{ ms}$
 – Retracting: $t_v = t_h \times k_r$
 $t_v = 490 \text{ ms} \times 1.5 = 735 \text{ ms}$

Stroke [mm]	Size	Advancing (k_a) ¹⁾	Retracting (k_r)
30	8, 10, 12	0.95	1.2
	16, 20, 25	0.9	1.5
50	8, 10, 12	0.9	1.5
	16, 20, 25	0.9	1.5
100	10, 12, 16, 20, 25	0.8	1.5
150	12, 16, 20, 25	0.9	1.5
200	20, 25	0.9	1.5

1) Downward

Mini slides DGSL

Technical data



Dynamic characteristic load values

Torques are indicated with reference to the centre of the guide.
These values must not be exceeded during dynamic operation. Special attention must be paid to the cushioning phase.

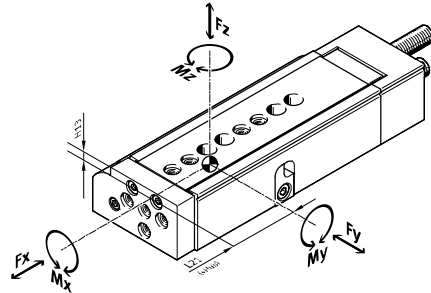

If the drive is simultaneously subjected to several of the indicated forces and torques, the following equation must be satisfied in addition to the indicated maximum loads:

$$\frac{|F_y|}{F_{y_{max}}} + \frac{|F_z|}{F_{z_{max}}} + \frac{|M_x|}{M_{x_{max}}} + \frac{|M_y|}{M_{y_{max}}} + \frac{|M_z|}{M_{z_{max}}} \leq 1$$

Position of the guide centre

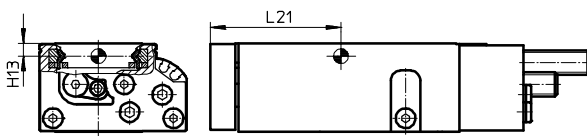

Calculation example

Given:

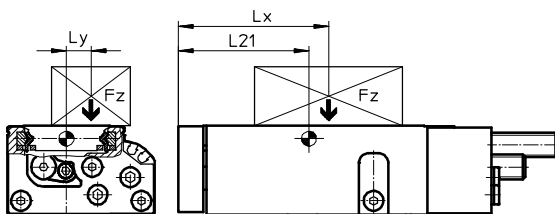

To be calculated:

Mini slide	= DGSL-10	F_y, F_z, M_x, M_y, M_z
Stroke length	= 80 mm	and
Lever arm L_x	= 50 mm	verification of operation with
Lever arm L_y	= 30 mm	combined load
Load F_z	= 0.8 kg	
Acceleration a	= 0 m/s ²	

Solution:

$L_{21} = 83$ mm from table

$F_y = 0$ N

$F_z = m \times g$
 $= 0.8 \text{ kg} \times 9.81 \text{ m/s}^2 = 7.848 \text{ N}$

$M_x = m \times g \times L_y$
 $= 0.8 \text{ kg} \times 9.81 \text{ m/s}^2 \times 30 \text{ mm} = 0.236 \text{ Nm}$

$M_y = m \times g \times [(L_{21} + \text{stroke}) - L_x]$
 $= 0.8 \text{ kg} \times 9.81 \text{ m/s}^2 \times [(83 \text{ mm} + 80 \text{ mm}) - 50 \text{ mm}] = 0.886 \text{ Nm}$

$M_z = 0$ Nm

Combined load:

$$\frac{|F_y|}{F_{y_{max}}} + \frac{|F_z|}{F_{z_{max}}} + \frac{|M_x|}{M_{x_{max}}} + \frac{|M_y|}{M_{y_{max}}} + \frac{|M_z|}{M_{z_{max}}} = 0 + \frac{7.848 \text{ N}}{1200 \text{ N}} + \frac{0.236 \text{ Nm}}{18 \text{ Nm}} + \frac{0.886 \text{ Nm}}{12 \text{ Nm}} + 0 = 0.094 \leq 1$$

Permissible forces and torques						Geometric characteristics	
Size	Stroke [mm]	$F_{y_{max}}$ [N]	$F_{z_{max}}$ [N]	$M_{x_{max}}$ [Nm]	$M_{y_{max}}, M_{z_{max}}$ [Nm]	H13 [mm]	L21 [mm]
4	10	343	343	2	2	2.7	31
	20	368	368	2	2		36
	30	387	387	2	2		42
6	10	540	540	6	4.5	3.4	37
	20	590	590	7	5		42
	30	631	631	8	5.5		47
	40	677	677	8	5.5		52
	50	719	719	8	5.5		57

Mini slides DGSL

Technical data

FESTO

Permissible forces and torques						Geometric characteristics	
Size	Stroke [mm]	F _y max [N]	F _z max [N]	M _x max [Nm]	M _y max, M _z max [Nm]	H13 [mm]	L21 [mm]
8							
	10	657	657	7	5.5	3.25	41
	20	745	745	8	5.5		46
	30	850	850	9	5.5		51
	40	934	934	10	5.5		56
	50	962	962	10	8		67
	80	971	971	10	8		82
10							
	10	927	927	15	6	4.2	43
	20	1,003	1,003	15	7		46
	30	1,078	1,078	15	8		51
	40	1,152	1,152	15	9		56
	50	1,175	1,175	18	9		61
	80	1,200	1,200	18	12		83
	100	1,250	1,250	18	12		96
12							
	10	942	942	15	8	5.2	44
	20	1,006	1,006	15	9		49
	30	1,075	1,075	15	10		54
	40	1,142	1,142	18	11		59
	50	1,200	1,200	18	12		64
	80	1,280	1,280	20	15		88
	100	1,340	1,340	20	15		98
	150	1,400	1,400	20	15	124	
16							
	10	1,769	1,769	35	20	6.4	54
	20	2,021	2,021	35	22		59
	30	2,274	2,274	35	22		64
	40	2,527	2,527	40	25		69
	50	2,780	2,780	40	25		74
	80	2,800	2,800	50	27		89
	100	2,850	2,850	50	43		113
	150	2,900	2,900	50	43	138	
20							
	10	2,911	2,911	60	30	7.55	56
	20	3,143	3,143	60	30		61
	30	3,354	3,354	60	30		66
	40	3,612	3,612	60	40		71
	50	3,816	3,816	70	50		76
	80	4,032	4,032	80	50		91
	100	4,200	4,200	85	80		121
	150	4,400	4,400	90	80	152	
	200	4,600	4,600	90	80	177	
25							
	10	3,270	3,270	100	60	8.55	64
	20	3,744	3,744	100	60		69
	30	4,205	4,205	100	60		74
	40	4,643	4,643	110	60		79
	50	4,650	4,650	120	60		84
	80	4,700	4,700	130	80		112
	100	4,750	4,750	130	80		129
	150	4,800	4,800	130	80	154	
	200	4,800	4,800	130	80	179	

Mini slides DGSL

Technical data

FESTO

Dimensions

Download CAD data → www.festo.com

Size 4 ... 10

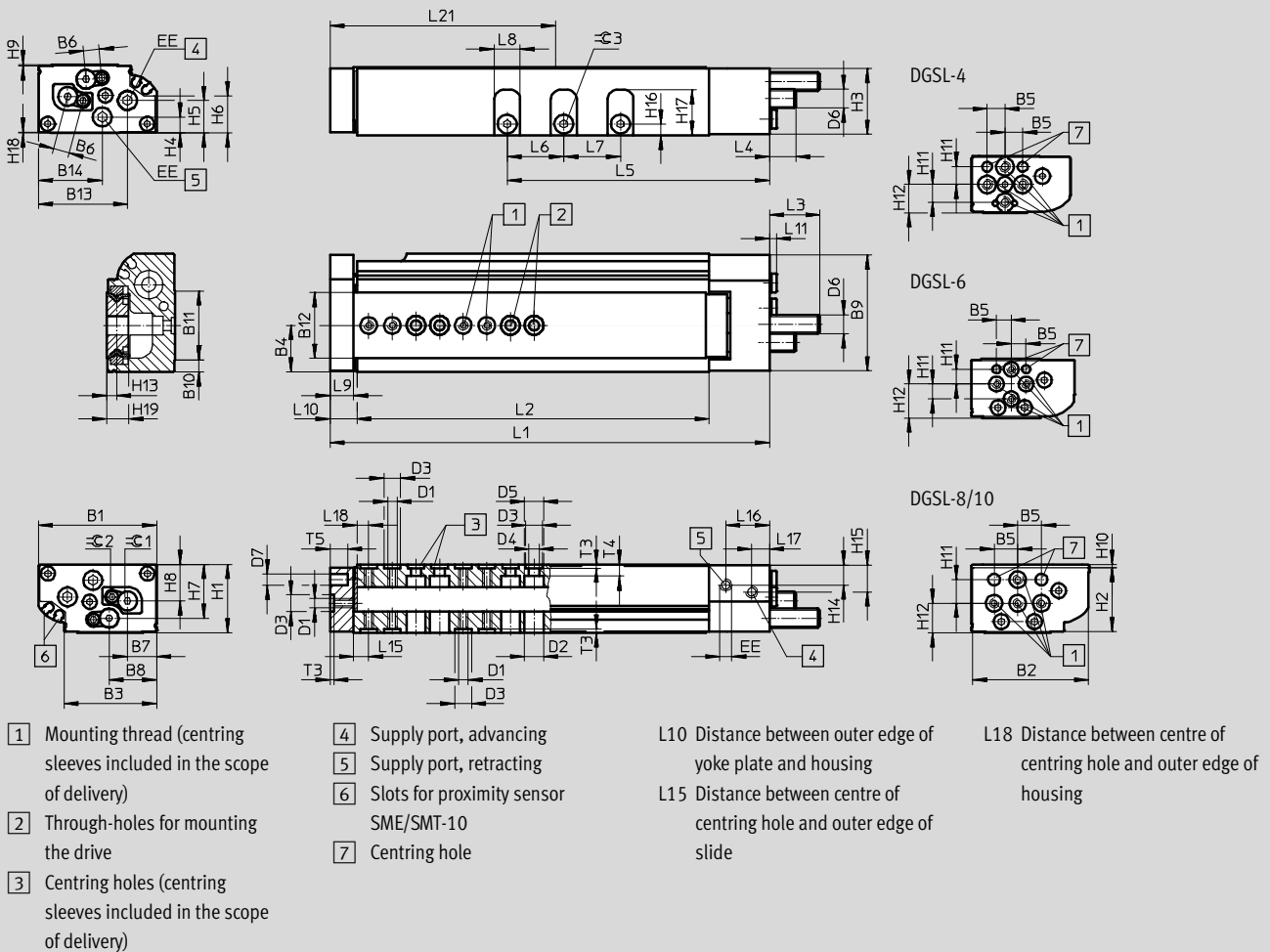

General dimensions

Size	B1	B2	B3	B4	B5	B6	B7	B8	B9	B10	B11	B12	B13	B14	D1
4	28	27.4	18.35	9.4	5	3.55	6.3	11.95	27.5	2	17.2	12.4	23.15	16.15	M3
6	35	34.5	26.3	13.5	5	5	8.2	13.55	34.5	3.5	19.9	20	28.1	18.9	M3
8	42	41.3	31.45	16.6	10	6	10.3	16.25	41.5	4.57	24	24.1	33	24.4	M4
10	50	49	39.2	19.65	10	6.8	12.35	20.1	49	5	29.2	28	37.7	27	M4

Size	D2	D3	D4	D5	D6	D7	EE	H1	H2	H3	H4	H5	H6	H7	H8
	∅	∅	∅	∅		∅		±0.08							
4	6.3	5 ^{H7}	3.3	6.2	M4x0.5	3 ^{H7}	M3	16	15.4	15.1	3.85	6.25	8.55	8.1	8.4
6	6.3	5 ^{H7}	3.3	6.2	M5x0.5	3 ^{H7}	M3	20	19	19.25	4.7	7.8	10.2	16.05	10.55
8	8.2	7 ^{H7}	4.3	8	M6x0.5	5 ^{H7}	M3	24	22.7	23	6.46	10.63	14.06	18.9	13.3
10	8.2	7 ^{H7}	4.3	8	M8x1	5 ^{H7}	M5	29	27.1	28	6.8	13.8	15.8	22.8	15.5

Size	H9	H10	H11	H12	H13	H14	H15	H16	H17	H18	H19	T3	T4	T5	⌀2 ¹⁾	⌀3
												+0.1				
4	0.65	0.3	5	8	2.7	5.35	5.85	3.1	10.6	0.25	5.28	1.3	2.25	4	1.3	2
6	0.45	0.5	5	11.5	3.38	6.5	7.2	3.7	13.1	0.3	6.68	1.3	3.7	6	1.5	2.5
8	0.64	0.9	10	8.7	3.28	7.8	10.5	4.1	16.8	0.36	6.7	1.6	3.8	7.5	2	2.5
10	0.6	1.4	10	12.5	4.2	8.76	11.76	4.8	19.25	0.41	9	1.6	5.35	7.5	2.5	3

1) With size 4, the scope of delivery of the drive includes an Allen key

Mini slides DGSL

Technical data



Stroke-dependent dimensions															
Size	Stroke	L1	L2	L5	L6	L7	L8	L9	L10	L11	L15 ±0.05	L16	L17	L18 ±0.05	L21
4	10	72.1	48	28.85	–	–	6.5	5.5	6.6	2.5	4	13.25	4.95	3	31
	20	81.2	57.1	37.95	10										36
	30	91.2	67.1	47.95	11										42
6	10	81.1	54	33.1	–	–	8	8	9.6	2.5	5.1	13.25	4.95	3.5	37
	20	91.1	64	43.1	14										42
	30	101.1	74	53.1	–										47
	40	111.1	84	63.1	–										52
	50	121.1	94	73.1	–										57
8	10	90.2	59.6	34.6	–	–	8	10	11.6	2.5	7	14.65	6.1	5.5	41
	20	100.2	69.6	44.6	10										46
	30	110.2	79.6	54.6	16										51
	40	120.2	89.6	64.6	–										56
	50	142.2	111.6	74.6	–										67
	80	172.2	141.6	104.6	16										82
10	10	103.1	66	41.3	–	–	11	10	11.6	2.5	6.4	18.5	7.5	5	43
	20	112.8	75.7	51	–										46
	30	122.8	85.7	61	–										51
	40	132.8	95.7	71	–										56
	50	142.8	105.7	81	–										61
	80	186.2	149.1	111	24										83
	100	206.2	169.1	131	24										24

Cushioning-dependent dimensions					
Size	Cushioning	L3 max.	L4 max.	≈ 1	
				For adjusting the cushioning stroke	For adjusting the end position
4	P	15.2	7.8	–	1.3
	E	5.7	0	–	1.3
	P1	14	6	1.3	2.5
6	P	17.6	8.1	–	1.5
	E	6.6	0	–	1.5
	P1	15.5	5.8	1.5	3
8	P	21.1	10.7	–	2
	E	6.6	0	–	2
	P1	19	9.1	2	4
	Y3	24.3	23.9	–	2
10	P	22.8	12.5	–	2.5
	E	8.8	0	–	2.5
	P1	20.5	10.2	2.5	5
	Y3	25.5	14.9	–	2.5
	Y11	30.4	19.9	–	2

Mini slides DGSL

Technical data

FESTO

Hole pattern for mounting threads and centring holes

DGSL-4-10

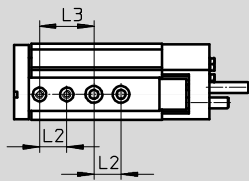

DGSL-4-20

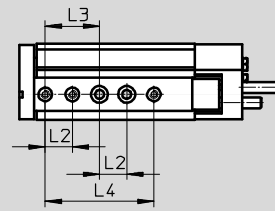

DGSL-4-30

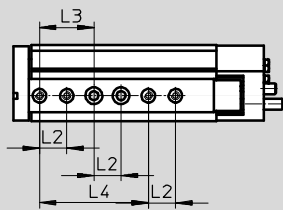

DGSL-6-10

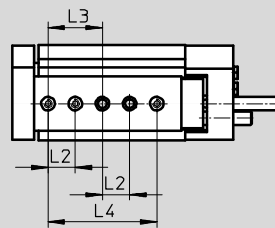

DGSL-6-20

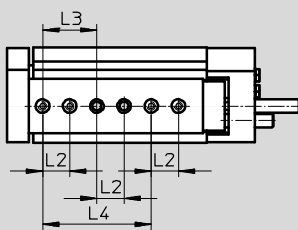

DGSL-6-30

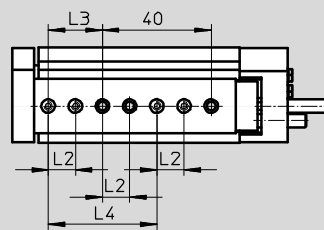

DGSL-6-40/50

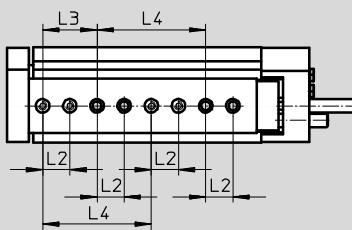

DGSL-8-10

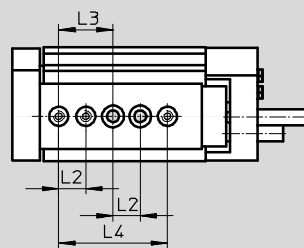

DGSL-8-20

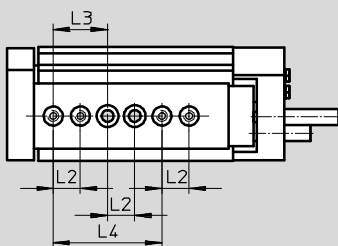

DGSL-8-30

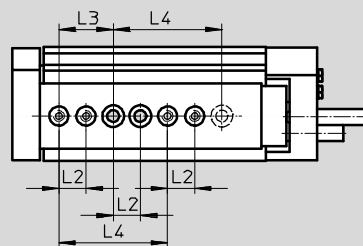

Mini slides DGSL

Technical data

Hole pattern for mounting threads and centring holes

DGSL-8-40

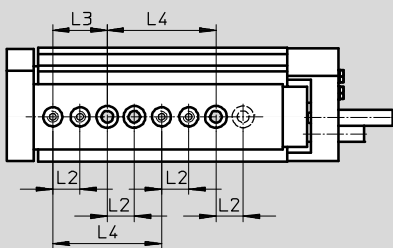

DGSL-8-50/80

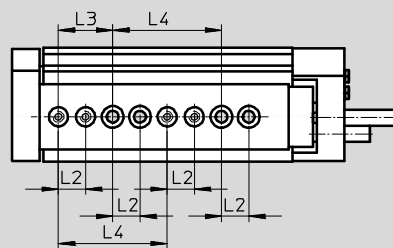

DGSL-10-10

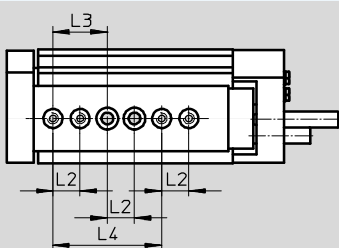

DGSL-10-20

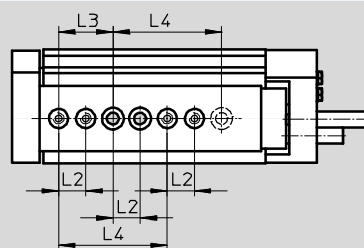

DGSL-10-30

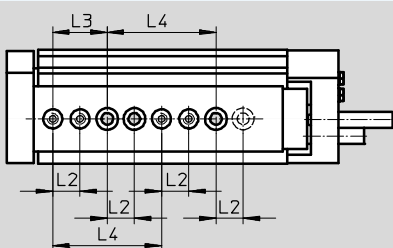

DGSL-10-40 ... 100

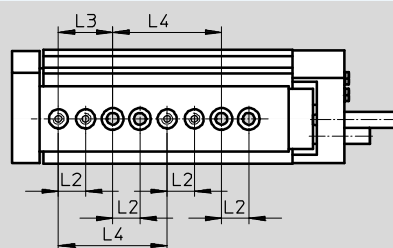

Distances from yoke plate to mounting threads and centring holes

DGSL-4 ... 10

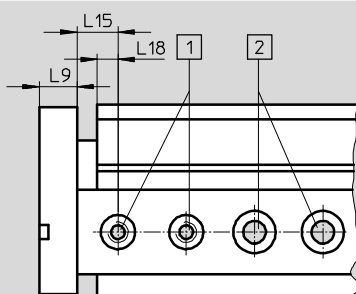

- 1 Centring holes with thread
- 2 Through-holes for mounting the drive

Size	L2 ¹⁾	L3 ¹⁾	L4 ¹⁾	L9	L15 ±0.05	L18
4	10	20	40	5.5	4	3
6	10	20	40	8	5.1	3.5
8	10	20	40	10	7	5.5
10	10	20	40	10	6.4	5

1) Tolerance for centring hole ±0.02
Tolerance for through-hole ±0.1

Mini slides DGSL

Technical data



Dimensions

Download CAD data → www.festo.com

Size 12/16

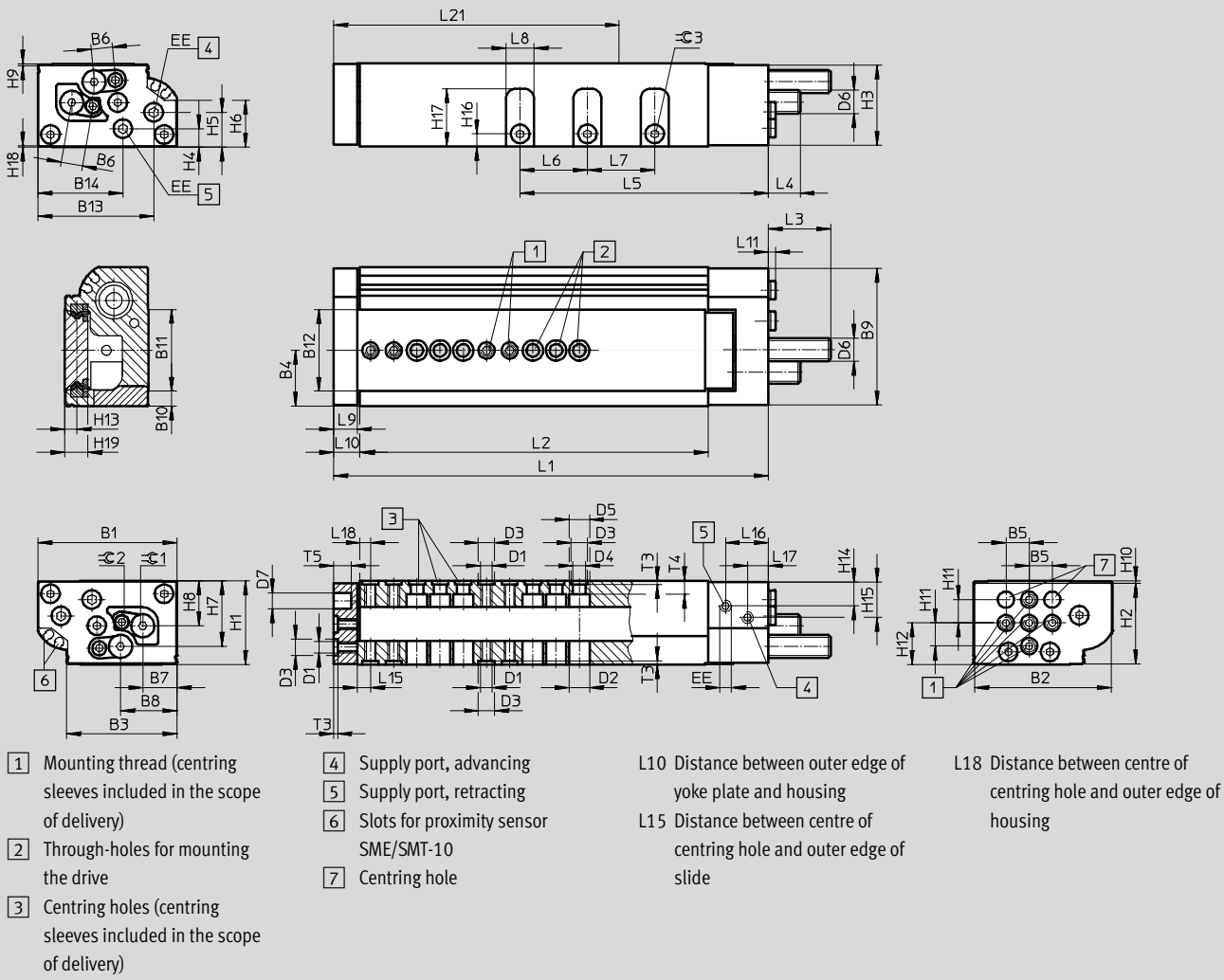

General dimensions

Size	B1	B2	B3	B4	B5	B6	B7	B8	B9	B10	B11	B12	B13	B14	D1
12	60	59	47.6	24	10	9.2	14.7	24.3	59	6.45	35.25	35.2	50	36.7	M5
16	66	65	53.5	26.7	10	11.1	16.7	27.5	65	7.75	37.9	38	50.4	36.7	M5

Size	D2	D3	D4	D5	D6	D7	EE	H1	H2	H3	H4	H5	H6	H7	H8
	∅	∅	∅	∅		∅		±0.08							
12	9	7 ^{H7}	5.5	9	M10x1	8 ^{H7}	M5	36	34.8	34.7	8	15.1	20.35	28.2	19.3
16	9	7 ^{H7}	5.5	9	M12x1	8 ^{H7}	M5	40	38	39	8.5	16.7	20.6	31.7	20.8

Size	H9	H10	H11	H12	H13	H14	H15	H16	H17	H18	H19	T3	T4	T5	∅ 2	∅ 3
												+0.1				
12	0.8	0.95	10	17.9	5.2	10.75	15.75	5.5	24.9	0.5	10.1	1.6	5.6	7.5	3	3
16	0.5	1.5	10	20	6.4	10.5	16.7	7	26.6	0.5	12.5	1.6	6.1	9	4	4

Mini slides DGSL

Technical data

FESTO

Stroke-dependent dimensions															
Size	Stroke	L1	L2	L5	L6	L7	L8	L9	L10	L11	L15 ±0.05	L16	L17	L18 ±0.05	L21
12	10	106.2	68.6	42.4	-	-	12	10	11.6	2.5	5.8	18.5	9	4.5	44
	20	116.2	78.6	52.4											49
	30	126.2	88.6	62.4											54
	40	136.2	98.6	72.4											59
	50	146.2	108.6	82.4	29										64
	80	197.6	160	112.4											88
	100	217.6	180	132.4											98
	150	267.6	230	182.4											124
16	10	124.1	82.5	45	-	-	14	12	13.6	2.5	6.8	21	10	5.5	54
	20	134.6	93	54.6											59
	30	144.6	103	64.6											64
	40	154.6	113	74.6											69
	50	164.6	123	84.6	35										74
	80	194.6	153	114.6											89
	100	243.6	202	134.6											113
	150	293.6	252	184.6											138

Cushioning-dependent dimensions					
Size	Cushioning	L3 max.	L4 max.	≈ 1	
				For adjusting the cushioning stroke	For adjusting the end position
12	P	28.1	14.9	-	3
	E	8.8	0	-	3
	P1	26	12.8	3	6
	Y3	36.9	23.7	-	3
	Y11	42.2	18.7	-	2.5
16	P	42.3	26.1	-	4
	E	8.8	0	-	4
	P1	40	23.8	4	8
	Y3	51.9	35.7	-	4
	Y11	55.4	38.9	-	3

Mini slides DGSL

Technical data

FESTO

Hole pattern for mounting threads and centring holes

DGSL-12-10

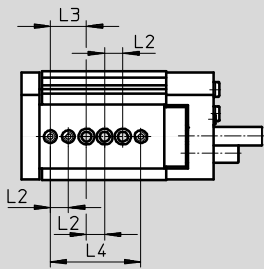

DGSL-12-20

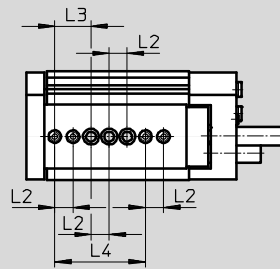

DGSL-12-30

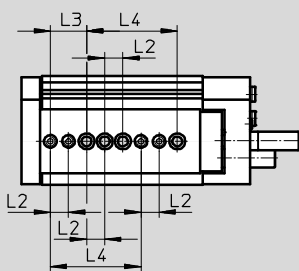

DGSL-12-40

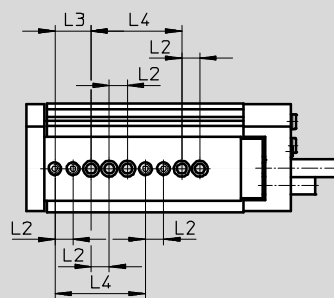

DGSL-12-50 ... 100

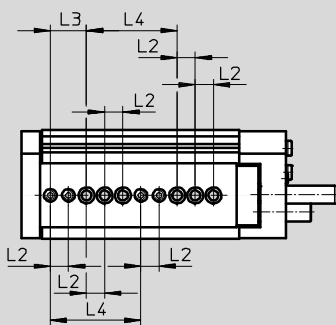

DGSL-12-150

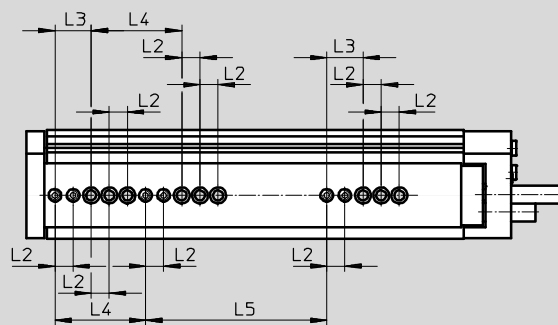

DGSL-16-10

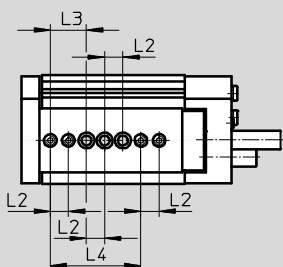

DGSL-16-20

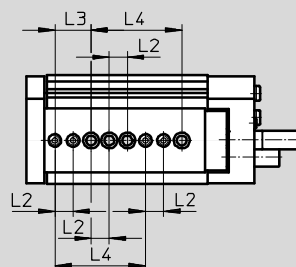

Mini slides DGSL

Technical data

Hole pattern for mounting threads and centring holes

DGSL-16-30

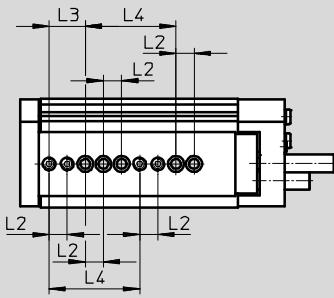

DGSL-16-40 ... 100

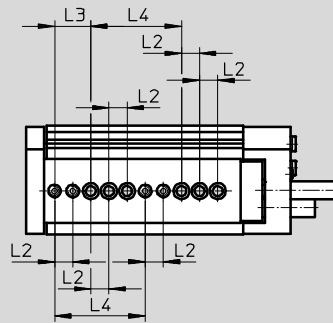

DGSL-16-150

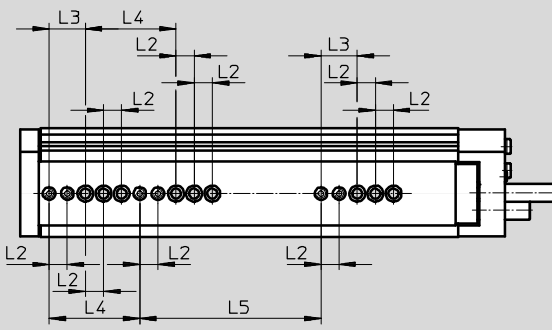

Distances from yoke plate to mounting threads and centring holes

DGSL-12/16

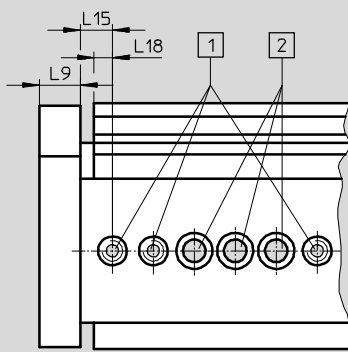

- 1 Centring holes with thread
- 2 Through-holes for mounting the drive

Size	L2 ¹⁾	L3 ¹⁾	L4 ¹⁾	L5 ±0.03	L9	L15 ±0.05	L18 ±0.05
12	10	20	50	100	10	5.8	4.5
16	10	20	50	100	12	6.8	5.5

1) Tolerance for centring hole ±0.02
Tolerance for through-hole ±0.1

Mini slides DGSL

Technical data



Dimensions

Download CAD data → www.festo.com

Size 20/25

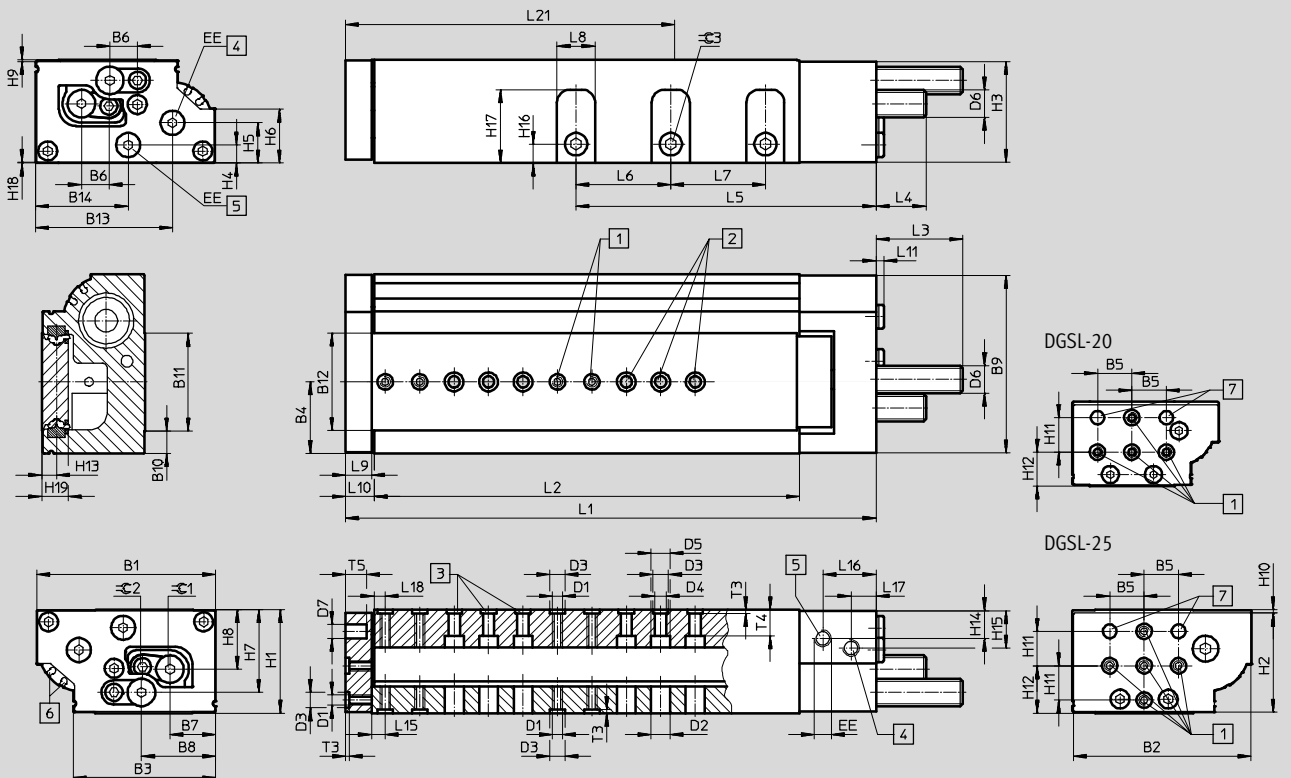

- 1 Mounting thread (centring sleeves included in the scope of delivery)
- 2 Through-holes for mounting the drive
- 3 Centring holes (centring sleeves included in the scope of delivery)
- 4 Supply port, advancing
- 5 Supply port, retracting
- 6 Slots for proximity sensor SME/SMT-10
- 7 Centring hole
- L10 Distance between outer edge of yoke plate and housing
- L15 Distance between centre of centring hole and outer edge of slide
- L18 Distance between centre of centring hole and outer edge of housing

General dimensions

Size	B1	B2	B3	B4	B5	B6	B7	B8	B9	B10	B11	B12	B13	B14	D1
20	85	84	68.85	34.5	20	14.15	21.4	36.35	83.4	10	48.9	49.2	64.1	48.6	M6
25	104	103	82.6	41.6	20	16.2	26.4	43.05	103	13.25	56.5	56.7	79.35	53.65	M6

Size	D2	D3	D4	D5	D6	D7	EE	H1	H2	H3	H4	H5	H6	H7	H8
	∅	∅	∅	∅		∅		±0.08							
20	11.2	9 ^{H7}	6.6	11	M14x1	8 ^{H7}	G ¹ / ₈	49	46.5	47.7	10.3	20.6	23.2	38.2	26.1
25	11.2	9 ^{H7}	6.6	11	M16x1	8 ^{H7}	G ¹ / ₈	60	57.5	58.5	10.45	23.35	31.15	47.95	34.5

Size	H9	H10	H11	H12	H13	H14	H15	H16	H17	H18	H19	T3	T4	T5	∠ 2	∠ 3
												+0.1				
20	0.5	2	20	19.6	7.55	14.7	14.7	10	33.3	0.8	14.6	2.1	8.6	10	4	5
25	1	2	20	27.5	8.55	16.55	21.15	11	42.7	0.45	15.6	2.1	15	12	5	6

Mini slides DGSL

Technical data



Stroke-dependent dimensions															
Size	Stroke	L1	L2	L5	L6	L7	L8	L9	L10	L11	L15 ±0.05	L16	L17	L18 ±0.05	L21
20	10	141.2	84.6	59.1	-	-	17	14	15.6	4.6	7.8	30.5	12	6.5	56
	20	151.2	94.6	69.1											61
	30	161.2	104.6	79.1											66
	40	171.2	114.6	89.1											71
	50	183.2	126.6	99.1											76
	80	211.2	154.6	129.1											91
	100	270.2	213.6	149.1	44	44	121								
	150	333.2	276.6	199.1			152								
	200	383.2	326.6	252.1			177								
25	10	157.1	96	63.7	-	-	22	15	16.6	4.6	8	32.3	14.5	6.5	64
	20	167.1	106	72.2											69
	30	177.1	116	82.2											74
	40	187.1	126	92.2											79
	50	197.1	136	102.2											84
	80	253.1	192	132.2											55
	100	286.1	225	152.2	129										
	150	338.1	277	202.2	154										
	200	388.1	327	254.2	179										

Cushioning-dependent dimensions					
Size	Cushioning	L3 max.	L4 max.	≈ 1	
				For adjusting the cushioning stroke	For adjusting the end position
20	P	52.4	31.2	-	4
	E	8.8	0	-	4
	P1	50.1	28.9	4	8
	Y3	55.5	34.3	-	4
	Y11	67.4	45.9	-	4
25	P	51.9	30.5	-	5
	E	8.8	0	-	5
	P1	49.6	28.2	5	10
	Y3	65.2	43.8	-	5
	Y11	78.4	56.9	-	4

Mini slides DGSL

Technical data

Hole pattern for mounting threads and centring holes

DGSL-20-10/20

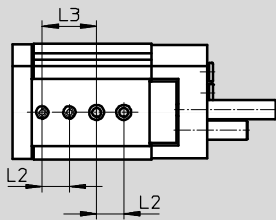

DGSL-20-30/40

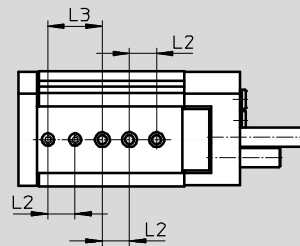

DGSL-20-50

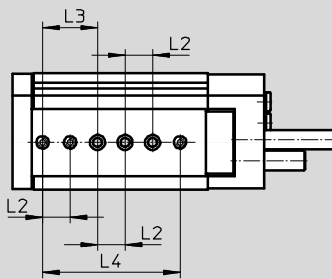

DGSL-20-80

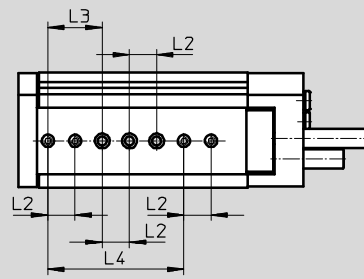

DGSL-20-100 ... 200

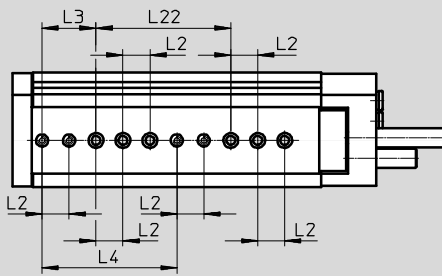

DGSL-25-10

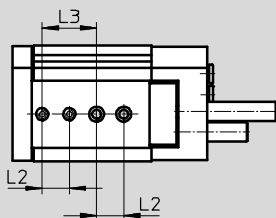

DGSL-25-20

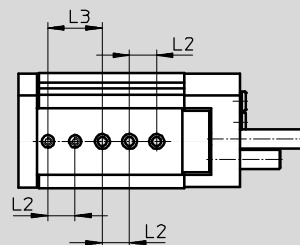

Mini slides DGSL

Technical data

Hole pattern for mounting threads and centring holes

DGSL-25-30/40

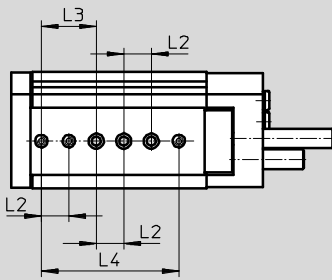

DGSL-25-50

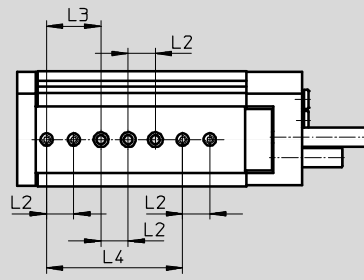

DGSL-25-80

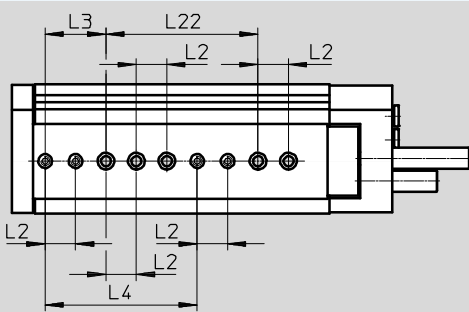

DGSL-25-100 ... 200

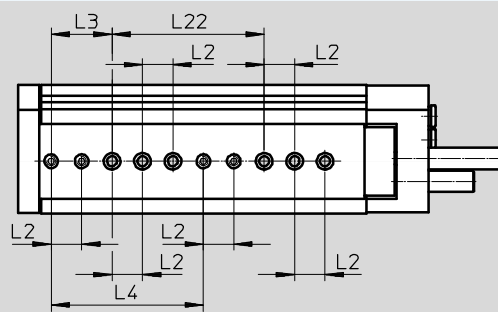

Distances from yoke plate to mounting threads and centring holes

DGSL-20/25

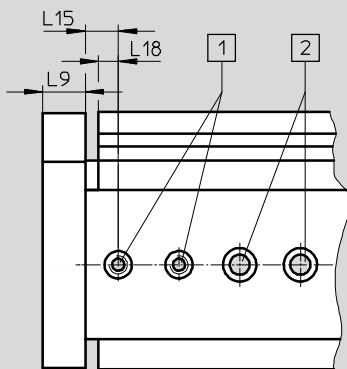

- 1 Centring holes with thread
- 2 Through-holes for mounting the drive

Size	L2 ¹⁾	L3 ¹⁾	L4	L9	L15 ±0.05	L18 ±0.05	L22
20	20	40	100 ¹⁾	14	7.8	6.5	100±0.03
25	20	40	100±0.03	15	8	6.5	100 ¹⁾

1) Tolerance for centring hole ±0.02
Tolerance for through-hole ±0.1

Mini slides DGSL-C/-E3

Technical data

FESTO

Function

C – Clamping unit

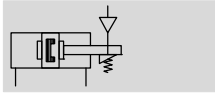

E3 – End-position locking

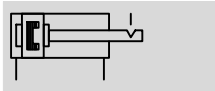

Size
6 ... 25

Wearing parts kits
→ 45



Note

Additional measures are required for use in safety-related applications; in Europe, for example, the standards listed under the EC Machinery Directive must be observed. Without

additional measures in accordance with statutory minimum requirements, the product is not suitable for use in safety-related sections of control systems.

General technical data – Clamping unit								
Size		6	8	10	12	16	20	25
Function		– Mechanical clamping – For fixing the slide in any position – Frictional locking						
Clamping type with operating direction		At both ends						
		Clamping via spring force, released via compressed air						
Pneumatic connection		M5						
Mounting position		Any						
Static holding force	[N]	80	80	180	180	350	350	600
Product weight	[g]	10	10	15	15	50	50	50

Operating and environmental conditions – Clamping unit	
Operating medium	Compressed air to ISO 8573-1:2010 [7:4:4]
Note on operating/pilot medium	Lubricated operation possible (in which case lubricated operation will always be required)
Min. release pressure	[bar] 3
Max. operating pressure	[bar] ≤ 10

General technical data – End-position locking								
Size		6	8	10	12	16	20	25
Function		– Mechanical locking when the end position is reached – For fixing the slide in the unpressurised, retracted state – Positive locking						
Clamping type with operating direction		At both ends						
		Clamping via spring force, unlocked via compressed air						
Pneumatic connection		M5						
Mounting position		Any						
Static holding force	[N]	60	60	160	160	250	380	640
Product weight	[g]	13	13	26	26	64	64	65

Operating and environmental conditions – End-position locking	
Operating medium	Compressed air to ISO 8573-1:2010 [7:4:4]
Note on operating/pilot medium	Lubricated operation possible (in which case lubricated operation will always be required)
Operating pressure	[bar] 3 ... 8

Mini slides DGSL-C/-E3

Technical data

Adjustable end-position range

When using end-position locking (E3), the adjustable range of the retracted end position is reduced by the following values.

1 Adjustable end-position range

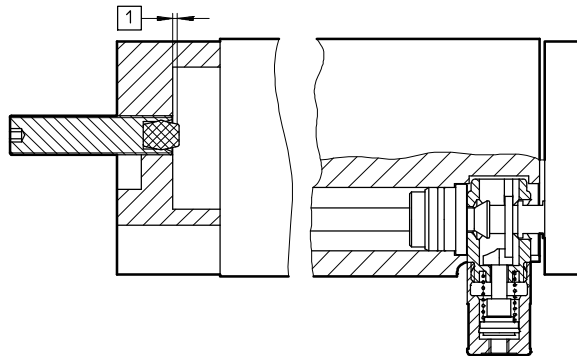

Size	1
6, 8	Max. 1.5 mm
10, 12	Max. 2.3 mm
16, 20, 25	Max. 2.7 mm

Dimensions

Download CAD data → www.festo.com

C – Clamping unit/E3 – End-position locking

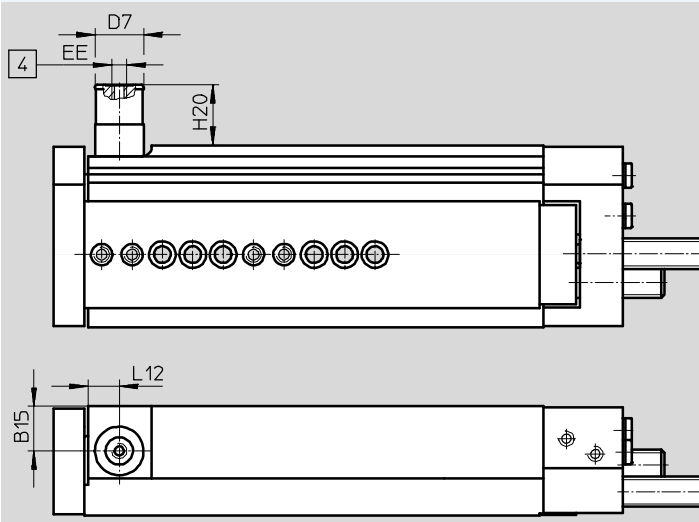

4 Supply port

Size	B15	D7 ∅	EE	H20		L12
				C	E3	
6	7.2	12	M5	10.7	21.2	7.3
8	9.9	12		10.5	21	7.3
10	11.2	16		11.8	21.2	10.5
12	14.8	16		10.5	19.9	10.3
16	14	20		27.5	30.5	13
20	17	20		21.3	24.3	14
25	22.55	20		17.75	20.65	14

Mini slides DGSL

Technical data

FESTO

Ordering data							
Size	Stroke [mm]	Part No.	Type	Size	Stroke [mm]	Part No.	Type
With cushioning P				With cushioning E			
4	10	543910	DGSL-4-10-PA	4	10	570158	DGSL-4-10-EA
	20	543911	DGSL-4-20-PA		20	570159	DGSL-4-20-EA
	30	543912	DGSL-4-30-PA		30	570160	DGSL-4-30-EA
6	10	543916	DGSL-6-10-PA	6	10	570161	DGSL-6-10-EA
	20	543917	DGSL-6-20-PA		20	570162	DGSL-6-20-EA
	30	543918	DGSL-6-30-PA		30	570163	DGSL-6-30-EA
	40	543919	DGSL-6-40-PA		40	570164	DGSL-6-40-EA
	50	543920	DGSL-6-50-PA		50	570165	DGSL-6-50-EA
8	10	543926	DGSL-8-10-PA	8	10	570166	DGSL-8-10-EA
	20	543927	DGSL-8-20-PA		20	570167	DGSL-8-20-EA
	30	543928	DGSL-8-30-PA		30	570168	DGSL-8-30-EA
	40	543929	DGSL-8-40-PA		40	570169	DGSL-8-40-EA
	50	543930	DGSL-8-50-PA		50	570170	DGSL-8-50-EA
10	80	543931	DGSL-8-80-PA	10	80	570171	DGSL-8-80-EA
	10	543942	DGSL-10-10-PA		10	570172	DGSL-10-10-EA
	20	543943	DGSL-10-20-PA		20	570173	DGSL-10-20-EA
	30	543944	DGSL-10-30-PA		30	570174	DGSL-10-30-EA
	40	543945	DGSL-10-40-PA		40	570175	DGSL-10-40-EA
	50	543946	DGSL-10-50-PA		50	570176	DGSL-10-50-EA
12	80	543947	DGSL-10-80-PA	12	80	570177	DGSL-10-80-EA
	100	543948	DGSL-10-100-PA		100	570178	DGSL-10-100-EA
	10	543961	DGSL-12-10-PA		10	570179	DGSL-12-10-EA
	20	543962	DGSL-12-20-PA		20	570180	DGSL-12-20-EA
	30	543963	DGSL-12-30-PA		30	570181	DGSL-12-30-EA
	40	543964	DGSL-12-40-PA		40	570182	DGSL-12-40-EA
	50	543965	DGSL-12-50-PA		50	570183	DGSL-12-50-EA
16	80	543966	DGSL-12-80-PA	16	80	570184	DGSL-12-80-EA
	100	543967	DGSL-12-100-PA		100	570185	DGSL-12-100-EA
	150	543968	DGSL-12-150-PA		150	570186	DGSL-12-150-EA
	10	543983	DGSL-16-10-PA		10	570187	DGSL-16-10-EA
	20	543984	DGSL-16-20-PA		20	570188	DGSL-16-20-EA
20	30	543985	DGSL-16-30-PA	20	30	570189	DGSL-16-30-EA
	40	543986	DGSL-16-40-PA		40	570190	DGSL-16-40-EA
	50	543987	DGSL-16-50-PA		50	570191	DGSL-16-50-EA
	80	543988	DGSL-16-80-PA		80	570192	DGSL-16-80-EA
	100	543989	DGSL-16-100-PA		100	570193	DGSL-16-100-EA
	150	543990	DGSL-16-150-PA		150	570194	DGSL-16-150-EA
	10	544005	DGSL-20-10-PA		10	570195	DGSL-20-10-EA
25	20	544006	DGSL-20-20-PA	25	20	570196	DGSL-20-20-EA
	30	544007	DGSL-20-30-PA		30	570197	DGSL-20-30-EA
	40	544008	DGSL-20-40-PA		40	570198	DGSL-20-40-EA
	50	544009	DGSL-20-50-PA		50	570199	DGSL-20-50-EA
	80	544010	DGSL-20-80-PA		80	570200	DGSL-20-80-EA
	100	544011	DGSL-20-100-PA		100	570201	DGSL-20-100-EA
	150	544012	DGSL-20-150-PA		150	570202	DGSL-20-150-EA
	200	544013	DGSL-20-200-PA		200	570203	DGSL-20-200-EA
25	10	544030	DGSL-25-10-PA	25	10	570204	DGSL-25-10-EA
	20	544031	DGSL-25-20-PA		20	570205	DGSL-25-20-EA
	30	544032	DGSL-25-30-PA		30	570206	DGSL-25-30-EA
	40	544033	DGSL-25-40-PA		40	570207	DGSL-25-40-EA
	50	544034	DGSL-25-50-PA		50	570208	DGSL-25-50-EA
	80	544035	DGSL-25-80-PA		80	570209	DGSL-25-80-EA
	100	544036	DGSL-25-100-PA		100	570210	DGSL-25-100-EA
	150	544037	DGSL-25-150-PA		150	570211	DGSL-25-150-EA
200	544038	DGSL-25-200-PA	200	570212	DGSL-25-200-EA		

Mini slides DGSL

Technical data

FESTO

Ordering data				Ordering data									
Size	Stroke [mm]	Part No.	Type	Size	Stroke [mm]	Part No.	Type						
With cushioning P1				With cushioning Y3									
4	10	543913	DGSL-4-10-P1A	4	10	-							
	20	543914	DGSL-4-20-P1A		6	20	-						
	30	543915	DGSL-4-30-P1A			6	30	-					
6	10	543921	DGSL-6-10-P1A	6			10	-					
	20	543922	DGSL-6-20-P1A		6		20	-					
	30	543923	DGSL-6-30-P1A			6	30	-					
	40	543924	DGSL-6-40-P1A				6	40	-				
	50	543925	DGSL-6-50-P1A					6	50	-			
8	10	543932	DGSL-8-10-P1A	8					10	-			
	20	543933	DGSL-8-20-P1A		8				20	-			
	30	543934	DGSL-8-30-P1A			8			30	543938	DGSL-8-30-Y3A		
	40	543935	DGSL-8-40-P1A				8		40	543939	DGSL-8-40-Y3A		
	50	543936	DGSL-8-50-P1A					8	50	543940	DGSL-8-50-Y3A		
	80	543937	DGSL-8-80-P1A						8	80	543941	DGSL-8-80-Y3A	
10	10	543949	DGSL-10-10-P1A	10						10	-		
	20	543950	DGSL-10-20-P1A		10					20	-		
	30	543951	DGSL-10-30-P1A			10				30	543956	DGSL-10-30-Y3A	
	40	543952	DGSL-10-40-P1A				10			40	543957	DGSL-10-40-Y3A	
	50	543953	DGSL-10-50-P1A					10		50	543958	DGSL-10-50-Y3A	
	80	543954	DGSL-10-80-P1A						10	80	543959	DGSL-10-80-Y3A	
	100	543955	DGSL-10-100-P1A							10	100	543960	DGSL-10-100-Y3A
12	10	543969	DGSL-12-10-P1A	12							10	-	
	20	543970	DGSL-12-20-P1A		12						20	-	
	30	543971	DGSL-12-30-P1A			12					30	543977	DGSL-12-30-Y3A
	40	543972	DGSL-12-40-P1A				12				40	543978	DGSL-12-40-Y3A
	50	543973	DGSL-12-50-P1A					12			50	543979	DGSL-12-50-Y3A
	80	543974	DGSL-12-80-P1A						12		80	543980	DGSL-12-80-Y3A
	100	543975	DGSL-12-100-P1A							12	100	543981	DGSL-12-100-Y3A
150	543976	DGSL-12-150-P1A	12	150							543982	DGSL-12-150-Y3A	
16	10	543991		DGSL-16-10-P1A	16						10	-	
	20	543992		DGSL-16-20-P1A		16					20	-	
	30	543993		DGSL-16-30-P1A			16				30	543999	DGSL-16-30-Y3A
	40	543994		DGSL-16-40-P1A				16			40	544000	DGSL-16-40-Y3A
	50	543995		DGSL-16-50-P1A					16		50	544001	DGSL-16-50-Y3A
	80	543996		DGSL-16-80-P1A						16	80	544002	DGSL-16-80-Y3A
	100	543997	DGSL-16-100-P1A	16							100	544003	DGSL-16-100-Y3A
150	543998	DGSL-16-150-P1A	16		150						544004	DGSL-16-150-Y3A	
20	10	544014			DGSL-20-10-P1A	20					10	-	
	20	544015			DGSL-20-20-P1A		20				20	-	
	30	544016			DGSL-20-30-P1A			20			30	544023	DGSL-20-30-Y3A
	40	544017			DGSL-20-40-P1A				20		40	544024	DGSL-20-40-Y3A
	50	544018			DGSL-20-50-P1A					20	50	544025	DGSL-20-50-Y3A
	80	544019		DGSL-20-80-P1A	20						80	544026	DGSL-20-80-Y3A
	100	544020	DGSL-20-100-P1A	20							100	544027	DGSL-20-100-Y3A
	150	544021	DGSL-20-150-P1A								20	150	544028
200	544022	DGSL-20-200-P1A	20			200						544029	DGSL-20-200-Y3A
25	10	544039				DGSL-25-10-P1A	25					10	-
	20	544040				DGSL-25-20-P1A		25				20	-
	30	544041				DGSL-25-30-P1A			25			30	544048
	40	544042				DGSL-25-40-P1A				25		40	544049
	50	544043			DGSL-25-50-P1A	25						50	544050
	80	544044		DGSL-25-80-P1A	25							80	544051
	100	544045		DGSL-25-100-P1A							25	100	544052
	150	544046	DGSL-25-150-P1A	25								150	544053
200	544047	DGSL-25-200-P1A	25				200					544054	DGSL-25-200-Y3A

Ordering data for modular products → 44

Mini slides DGSL

Ordering data – Modular product



M Mandatory data				O Options		M	
Module No.	Function	Size	Stroke	Clamping unit	End-position locking	Cushioning	Position sensing
543902	DGSL	4	10 ... 200	C	E3	P P1 Y3 E Y11 N	A
543903		6					
543904		8					
543905		10					
543906		12					
543907		16					
543908		20					
543909		25					
Ordering example							
543904	DGSL	- 8	- 30		E3	- Y3	A

Ordering table												
Size	4	6	8	10	12	16	20	25	Condi- tions	Code	Enter code	
M Module No.	543902	543903	543904	543905	543906	543907	543908	543909				
Function	Mini slide with recirculating ball bearing guide									DGSL	DGSL	
Size	4	6	8	10	12	16	20	25		...	-	
Stroke [mm]	10									10		
	20									20		
	30									30		
	-	40								40		
	-	50								50		
	-	-	80							80		
	-	-	-	100						100		
	-	-	-	-	150					150		
	-	-	-	-	-	-	200			200		
O Clamping unit	Attached									C	-	
O End-position locking	With piston rod in retracted position									E3	-	
M Cushioning	Elastic cushioning rings/pads at both ends, end positions adjustable									P		
	Elastic cushioning rings/pads at both ends, end positions adjustable, with fixed stop									P1		
	Progressive shock absorber, at both ends									Y3		
	Elastic cushioning rings/pads at both ends, end positions adjustable, short design									E		
	Progressive shock absorber with reducing sleeve, at both ends									Y11		
	No cushioning									N		
M Position sensing	Via proximity sensor									A	A	

- Note
Operation without cushioning components is not permitted.

- 1 E3 Not with clamping unit C
- 2 Y3, Y11 Minimum stroke 30 mm

Transfer order code

DGSL - - - - - **A**

Mini slides DGSL

Wearing parts kits and accessories



Ordering data – Wearing parts kits			Ordering data – Wearing parts kits		
Size	Part No.	Type	Size	Part No.	Type
4	713743	DGSL-4-...	12	713747	DGSL-12-...
6	713744	DGSL-6-...	16	713748	DGSL-16-...
8	713745	DGSL-8-...	20	713749	DGSL-20-...
10	713746	DGSL-10-...	25	713750	DGSL-25-...

Cover DADS

Material:
Anodised aluminum
Free of copper, PTFE and silicone
RoHS-compliant

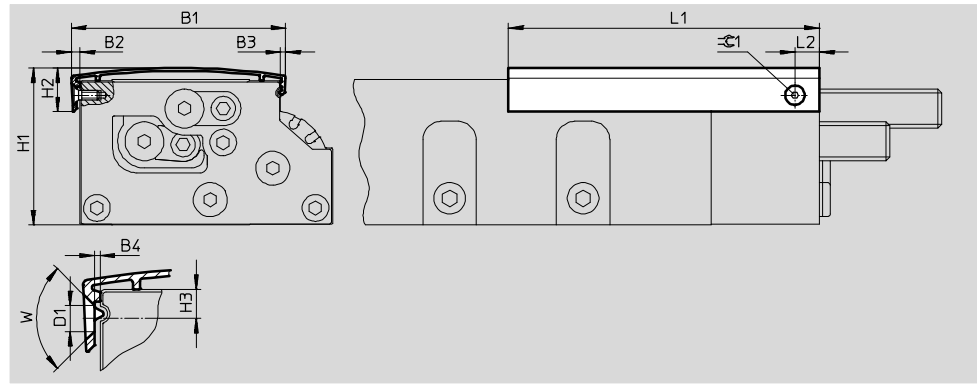

Dimensions and ordering data																
For size	Length [mm]	B1	B2	B3	B4	D1	H1	H2	H3	L1	L2	W	∓C1	Weight [g]	Part No.	Type
4	30	22	1.9	-	0.4	2.8	17.9	7.5	2	40	4.5	90°	-	2	1086663	DADS-AB-G6-4-30
	500									27				1212468	DADS-AB-G6-4-500	
6	50	31.2	1.4	-	0	2.8	22	8.2	2.5	63	6	90°	-	4	1066625	DADS-AB-G6-6-50
	500									33				1212476	DADS-AB-G6-6-500	
8	80	36.3	1.9	-	0.3	2.8	26.5	8.2	2	93	7	90°	-	8	1087413	DADS-AB-G6-8-80
	500									42				1212478	DADS-AB-G6-8-500	
10	50	43.6	2.8	2.2	1.2	3.4	32	12	3.4	70	10	90°	2	11	1162400	DADS-AB-G6-10-50
	100									18				1090689	DADS-AB-G6-10-100	
	500									75				1212479	DADS-AB-G6-10-500	
12	50	51.7	2.7	2	0.5	3.4	38.8	12.8	4.25	72	10	90°	2	12	1162406	DADS-AB-G6-12-50
	150									28				1090732	DADS-AB-G6-12-150	
	500									82				1212480	DADS-AB-G6-12-500	
16	50	60	4.3	3.1	2.25	3.4	43.7	15.2	5	73	10	90°	2	21	1162410	DADS-AB-G6-16-50
	150									49				1066591	DADS-AB-G6-16-150	
	500									141				1212503	DADS-AB-G6-16-500	
20	50	74.8	3.6	2.8	1.2	4.4	53.2	18.9	6.5	74	10	90°	2.5	28	1162412	DADS-AB-G6-20-50
	100									46				1162415	DADS-AB-G6-20-100	
	200									83				1090823	DADS-AB-G6-20-200	
	500									184				1212521	DADS-AB-G6-20-500	
25	50	88.4	3.5	2.7	0.7	4.4	64.7	18.3	6	78	10	90°	2.5	34	1162417	DADS-AB-G6-25-50
	100									55				1162419	DADS-AB-G6-25-100	
	200									98				1090895	DADS-AB-G6-25-200	
	500									213				1212523	DADS-AB-G6-25-500	

- - Note
With the 500 mm covers, the mounting hole must be made by the customer.
The cover can be trimmed as required by the customer.

Mini slides DGSL

Accessories



Intermediate position module DADM



- The intermediate position module enables an additional adjustable position within the stroke range. The module is attached separately, directly next to the mini slide. It can be mounted anywhere along the mini slide.
- The associated shock absorber retainer → 48 can be attached at several points on the slide. The position can be precisely adjusted using the shock absorber.
- The stop lever positions can be sensed via proximity sensor SME/SMT → 50.
- Push-in fittings are not included in the scope of delivery.

Material:
Housing: Wrought aluminium alloy
Lever: High-alloy stainless steel
RoHS-compliant

Dimensions and ordering data

Technical data → Internet: dadm

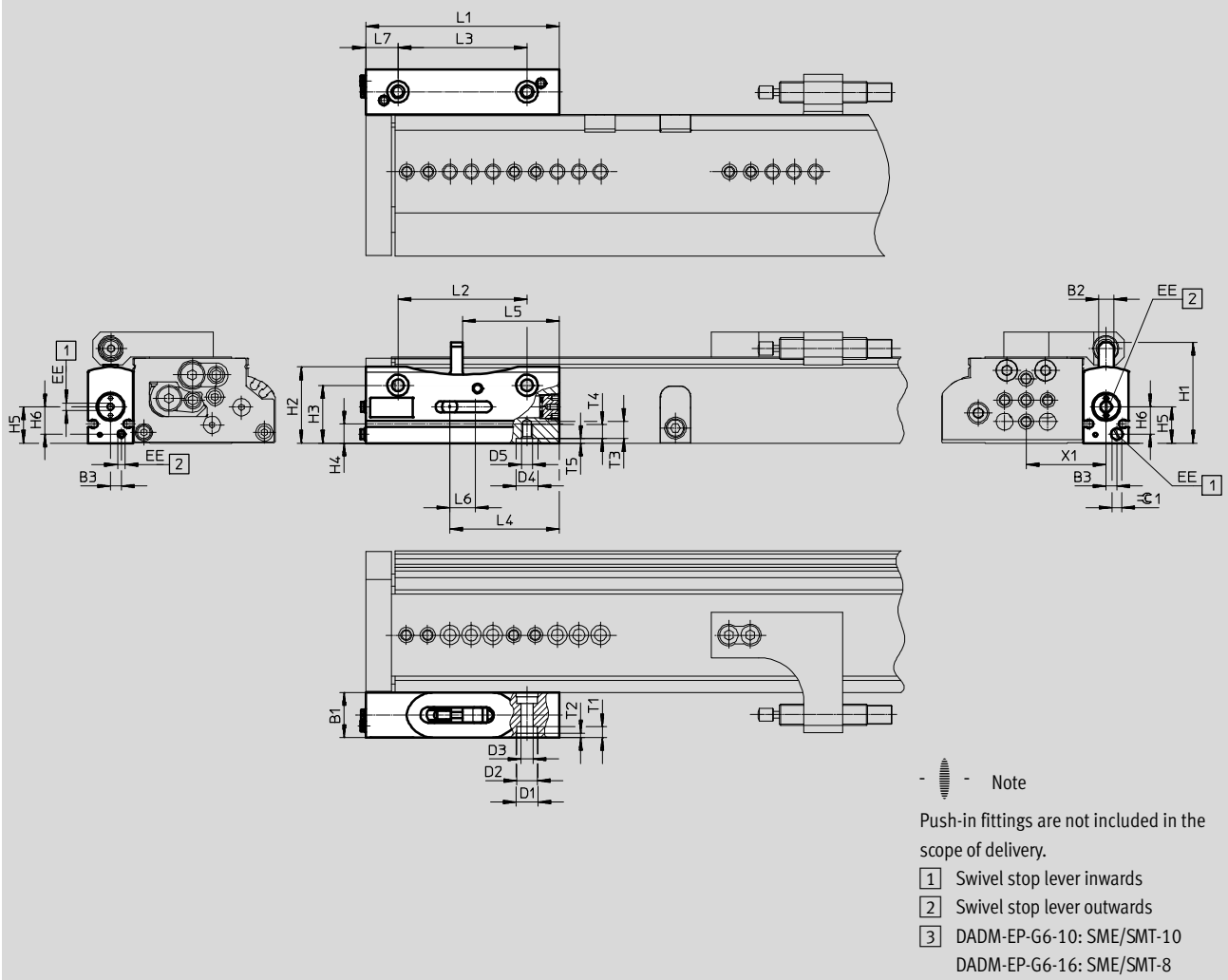

For size	B1	B2	B3	D1	D2	D3	D4	D5	EE	H1	H2
			±0.1	∅ H7	∅	∅	∅ H7				
12, 16	21	7	5	10	9.5	5.5	10	M5	M3	46.9	35.4
20, 25	26.5	9	5.5	12	11	6.6	12	M6	M5	65.2	47.4



Mini slides DGSL

Accessories

FESTO

For size	H3	H4	H5	H6	L1	L2	L3	L4	L5	L6	L7
	±0.1		±0.1	±0.1		±0.1	±0.1				
12, 16	26.9	8.9	16.9	12.7	90	60	60	51	45	12	15
20, 25	36.4	12.4	23.4	17	120	80	80	68	60	16	20

For size	T1	T2	T3	T4	T5	X1	⌀C1	Weight [g]	Part No.	Type
		+0.2			+0.1	+0.2				
12	5	2.1	8	6.5	2.1	34.5	4.5	154	1492072	DADM-EP-G6-10
16										
20	6.8	2.1	10	8	2.1	47.8	2.5	340	1478121	DADM-EP-G6-16
25										

Ordering data					
	For size	Description	Part No.	Type	PU ¹⁾
Connector sleeve ZBV Technical data → Internet: zbv					
	12, 16	For centring the intermediate position module (2 pieces included in scope of delivery for the intermediate position module)	560254	ZBV-10-9	10
Centring sleeve ZBH Technical data → Internet: zbh					
	20, 25	For centring the intermediate position module (2 pieces included in scope of delivery for the intermediate position module)	189653	ZBH-12	10

1) Packaging unit quantity

Mounting

The intermediate position module is mounted directly next to the mini slide and is fastened to the mounting surface using two screws and centring sleeves.

The shock absorber retainer is then mounted on the slide of the mini slide, also using two screws and centring sleeves.

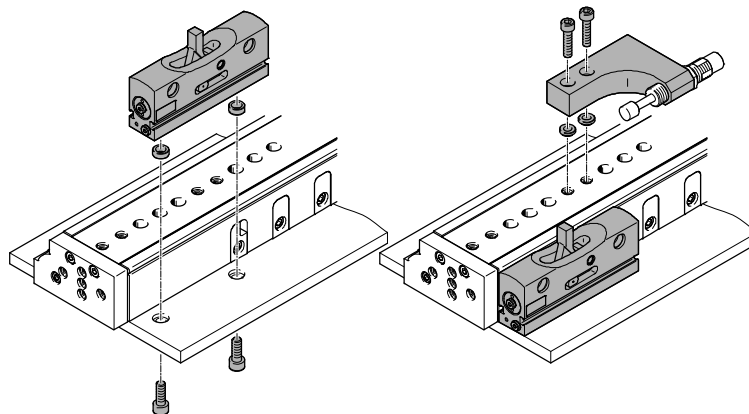

Precision adjustment:

The position can be precisely adjusted via the screw-in depth of the shock absorber. The shock absorber must project by at least $X = 1.5$ mm.

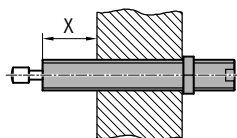

Mini slides DGSL

Accessories



Shock absorber retainer DADP

Material:
Anodised wrought aluminium alloy
RoHS-compliant

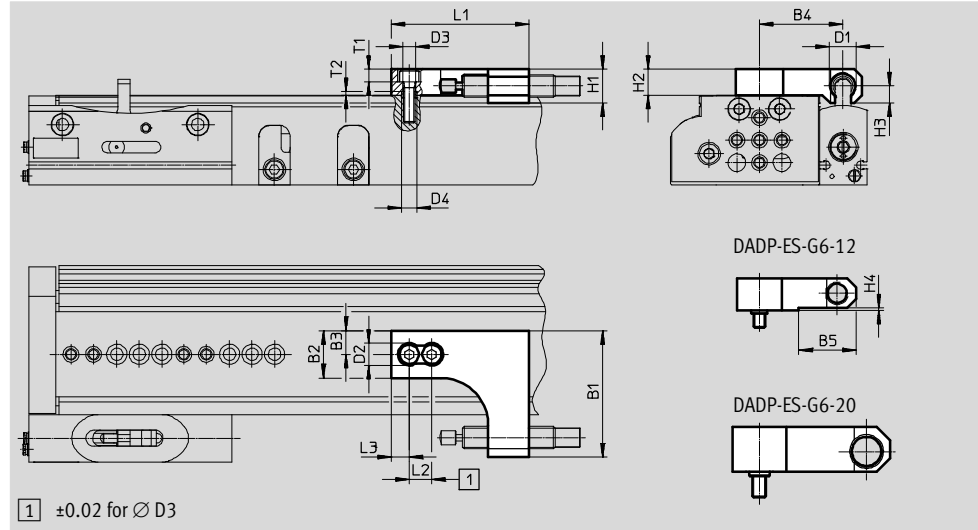

Dimensions and ordering data											
For size	B1	B2	B3	B4	B5	D1	D2 ∅	D3 ∅	D4 ∅ H7	H1	H2
12	53	20	10	34.5	25.5	M10x1	10	5.5	7	13	14
16	56	21	10.5	37	39.2	M12x1	10	5.5	7	15	12.2
20	70	24	12	47.5	-	M14x1	11	6.6	12	20	20
25	80	30	15	54.5	58	M16x1	11	6.6	12	25	14

For size	H3	H4	L1	L2	L3	T1	T2	Weight [g]	Part No.	Type
12	6.5	1	65	10	10	5.7	1.6	80	1812471	DADP-ES-G6-12
16	7.5	2.8	61	10	8	5.7	1.6	70	1812472	DADP-ES-G6-16
20	9	-	85	20	10	6.4	2.6	185	1812473	DADP-ES-G6-20
25	10	11	80	20	10	6.8	2.6	160	1812550	DADP-ES-G6-25

Ordering data					
	For size	Description	Part No.	Type	PU ¹⁾
Centring sleeve ZBH Technical data → Internet: zbh					
	12, 16	For centring the shock absorber retainer (2 pieces included in the scope of delivery of the shock absorber retainer)	186717	ZBH-7	10
Connector sleeve ZBV Technical data → Internet: zbv					
	20, 25	For centring the shock absorber retainer (2 pieces included in the scope of delivery of the shock absorber retainer)	548806	ZBV-12-9	10

1) Packaging unit

Note

- A shock absorber retainer DADP-ES is additionally required when using an intermediate position module
- Operation without cushioning components is not permitted
- Cushioning components are not included in the scope of delivery
- The shock absorbers for mini slides and for the associated shock absorber retainer are of identical size. Shock absorber selection → 49
- The same cushioning component as is used in the end positions of the mini slide is used for cushioning the intermediate position

Mini slides DGSL

Accessories



Ordering data							
	For size	For shock absorber retainer	Description	Order code	Part No.	Type	PU ¹⁾
Shock absorber DYEF-...-Y1 Technical data → Internet: dyef							
	4	–	Flexible cushioning, without metal stop	P	1179810	DYEF-M4-Y1	1
	6	–			1179818	DYEF-M5-Y1	
	8	–			1179831	DYEF-M6-Y1	
	10	–			1179834	DYEF-M8-Y1	
	12	DADP-ES-G6-12			1179837	DYEF-M10-Y1	
	16	DADP-ES-G6-16			1179840	DYEF-M12-Y1	
	20	DADP-ES-G6-20			1179863	DYEF-M14-Y1	
	25	DADP-ES-G6-25			1179879	DYEF-M16-Y1	
Shock absorber DYEF-S-...-Y1 Technical data → Internet: dyef							
	4	–	Flexible cushioning, without metal stop, short version	E	1152500	DYEF-S-M4-Y1	1
	6	–			1152507	DYEF-S-M5-Y1	
	8	–			1152524	DYEF-S-M6-Y1	
	10	–			1152536	DYEF-S-M8-Y1	
	12	DADP-ES-G6-12			1152959	DYEF-S-M10-Y1	
	16	DADP-ES-G6-16			1153004	DYEF-S-M12-Y1	
	20	DADP-ES-G6-20			1153017	DYEF-S-M14-Y1	
	25	DADP-ES-G6-25			1153023	DYEF-S-M16-Y1	
Shock absorber DYEF-...-Y1F Technical data → Internet: dyef							
	4	–	Flexible cushioning, with metal stop	P1	548370	DYEF-M4-Y1F	1
	6	–			548371	DYEF-M5-Y1F	
	8	–			548372	DYEF-M6-Y1F	
	10	–			548373	DYEF-M8-Y1F	
	12	DADP-ES-G6-12			548374	DYEF-M10-Y1F	
	16	DADP-ES-G6-16			548375	DYEF-M12-Y1F	
	20	DADP-ES-G6-20			548376	DYEF-M14-Y1F	
	25	DADP-ES-G6-25			548377	DYEF-M16-Y1F	
Shock absorber DYSW Technical data → Internet: dysw							
	8	–	Progressive shock absorbers, both ends	Y3	548070	DYSW-4-6-Y1F	1
	10	–			548071	DYSW-5-8-Y1F	
	12	DADP-ES-G6-12			548072	DYSW-7-10-Y1F	
	16	DADP-ES-G6-16			548073	DYSW-8-14-Y1F	
	20	DADP-ES-G6-20			548074	DYSW-10-17-Y1F	
	25	DADP-ES-G6-25			548075	DYSW-12-20-Y1F	
Reducing sleeve DAYH							
	10	–	For DYSW-4-6	–	1165476	DAYH-4	1
	12	DADP-ES-G6-12	For DYSW-5-8		1165480	DAYH-5	
	16	DADP-ES-G6-16	For DYSW-7-10		1165484	DAYH-7	
	20	DADP-ES-G6-20	For DYSW-8-14		1165488	DAYH-8	
	25	DADP-ES-G6-25	For DYSW-10-17		1165491	DAYH-10	

1) Packaging unit quantity



Mini slides DGSL

Accessories

FESTO

Ordering data					
	For size	Brief description	Part No.	Type	PU ¹⁾
Centring sleeve ZBH Technical data → Internet: zbh					
	4, 6	For centring loads and attachments (6 centring sleeves are included in the scope of delivery of the mini slide)	189652	ZBH-5	10
	8, 10, 12, 16		186717	ZBH-7	
	20, 25		150927	ZBH-9	
Connector sleeve ZBV Technical data → Internet: zbv					
	8, 10	<ul style="list-style-type: none"> For connecting two mini slides DGSL Sizing information refers to the Y-axis 	548802	ZBV-M4-7	3
	12, 16		548803	ZBV-M5-7	
	20, 25		548804	ZBV-M6-9	

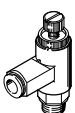

1) Packaging unit

Ordering data					
	For size	Brief description	Part No.	Type	PU ¹⁾
One-way flow control valve GRLA Technical data → Internet: grla					
	4, 6, 8	<ul style="list-style-type: none"> For regulating speed Only one GRLA-M3-QS-3 can be mounted on the front with size 4 	175041	GRLA-M3-QS-3	1
	10, 12, 16		175038	GRLA-M3	
	20, 25		193137	GRLA-M5-QS-3-D	
			193138	GRLA-M5-QS-4-D	
			193143	GRLA-1/8-QS-4-D	
	20, 25	193144	GRLA-1/8-QS-6-D		
		162965	GRLA-1/8-QS-6-RS-B		
162966	GRLA-1/8-QS-8-RS-B				
Push-in fitting QSM Technical data → Internet: quick star					
	4, 6, 8	For connecting compressed air tubing with standard O.D.	153301	QSM-M3-3	10
	10, 12, 16		153304	QSM-M5-4	
	20, 25		153307	QSM-1/8-6	

1) Packaging unit

Proximity sensors for mini slide DGSL and intermediate position module DADM-EP-G6-10

Ordering data – Proximity sensor for C-slot, magneto-resistive Technical data → Internet: smt					
	Type of mounting	Switching output	Electrical connection, connection direction	Cable length [m]	Part No. Type
N/O contact					
	Insertable in the slot from above	PNP	Cable, 3-wire, in-line	2.5	551373 SMT-10M-PS-24V-E-2,5-L-OE
			Plug M8x1, 3-pin, in-line	0.3	551375 SMT-10M-PS-24V-E-0,3-L-M8D
			Plug M8x1, 3-pin, angled	0.3	551376 SMT-10M-PS-24V-E-0,3-Q-M8D

Ordering data – Proximity sensor for C-slot, magnetic reed ¹⁾ Technical data → Internet: sme					
	Type of mounting	Switching output	Electrical connection, connection direction	Cable length [m]	Part No. Type
N/O contact					
	Insertable in the slot from above	Contacting	Plug M8x1, 3-pin, in-line	0.3	551367 SME-10M-DS-24V-E-0,3-L-M8D
			Cable, 3-wire, in-line	2.5	551365 SME-10M-DS-24V-E-2,5-L-OE
			Cable, 2-wire, in-line	2.5	551369 SME-10M-ZS-24V-E-2,5-L-OE
	Insertable in the slot lengthwise	Contacting	Plug M8x1, 3-pin, in-line	0.3	173212 SME-10-SL-LED-24
			Cable, 3-wire, in-line	2.5	173210 SME-10-KL-LED-24



1) Proximity sensors are not permitted with mini slide DGSL-4.

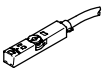

Mini slides DGSL

Accessories

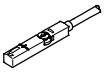
Proximity sensors for intermediate position module DADM-EP-G6-16

Ordering data – Proximity sensors for T-slot, magneto-resistive						Technical data → Internet: smt
	Type of mounting	Switch output	Electrical connection	Cable length [m]	Part No.	Type
N/O contact						
	Insertable in the slot from above, flush with cylinder profile, short design	PNP	Cable, 3-wire	2.5	574335	SMT-8M-A-PS-24V-E-2,5-OE
			Plug M8x1, 3-pin	0.3	574334	SMT-8M-A-PS-24V-E-0,3-M8D
		NPN	Plug M12x1, 3-pin	0.3	574337	SMT-8M-A-PS-24V-E-0,3-M12
			Cable, 3-wire	2.5	574338	SMT-8M-A-NS-24V-E-2,5-OE
			Plug M8x1, 3-pin	0.3	574339	SMT-8M-A-NS-24V-E-0,3-M8D

Ordering data – Proximity sensors for T-slot, magnetic reed						Technical data → Internet: sme
	Type of mounting	Switch output	Electrical connection	Cable length [m]	Part No.	Type
N/O contact						
	Insertable in the slot from above, flush with cylinder profile	Contacting	Cable, 3-wire	2.5	543862	SME-8M-DS-24V-K-2,5-OE
				5.0	543863	SME-8M-DS-24V-K-5,0-OE
			Cable, 2-wire	2.5	543872	SME-8M-ZS-24V-K-2,5-OE
			Plug M8x1, 3-pin	0.3	543861	SME-8M-DS-24V-K-0,3-M8D
	Insertable in the slot lengthwise, flush with the cylinder profile	Contacting	Cable, 3-wire	2.5	150855	SME-8-K-LED-24
			Plug M8x1, 3-pin	0.3	150857	SME-8-S-LED-24

Ordering data – Connecting cables					Technical data → Internet: nebu
	Electrical connection, left	Electrical connection, right	Cable length [m]	Part No.	Type
	Straight socket, M8x1, 3-pin	Cable, open end, 3-wire	2.5	541333	NEBU-M8G3-K-2.5-LE3
			5	541334	NEBU-M8G3-K-5-LE3
	Angled socket, M8x1, 3-pin	Cable, open end, 3-wire	2.5	541338	NEBU-M8W3-K-2.5-LE3
			5	541341	NEBU-M8W3-K-5-LE3

Mini slides DGSL

Accessories

FESTO

Adapter kit
HMSV

Material:
Wrought aluminium alloy
Free of copper and PTFE
RoHS-compliant

 Note
The kit includes the individual mounting interface as well as the necessary mounting material.

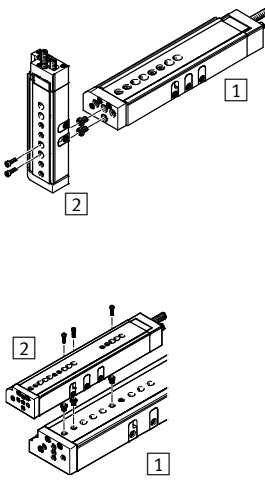
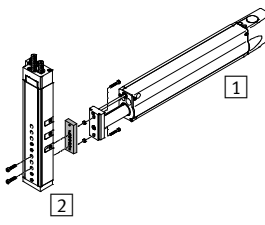
Permissible drive/drive combinations with adapter kit				Download CAD data → www.festo.com			
Combination	[1] Drive	[2] Drive	Adapter kit			Quantity required	PU ²⁾
	Size	Size	CRC ¹⁾	Part No.	Type		
DGSL/DGSL	DGSL	DGSL					
	4	4	2	–	M3x7 DIN 912 ³⁾	2	–
				189652	ZBH-5 ⁴⁾	2	10
	6	4, 6		–	M3x10 DIN 912 ³⁾	2	–
				189652	ZBH-5 ⁴⁾	2	10
	8, 10	4, 6		548802	ZBV-M4-7	1	3
	8, 10	8		–	M4x12 DIN 912 ³⁾	2	–
				186717	ZBH-7 ⁴⁾	2	10
	10	10		–	M4x14 DIN 912 ³⁾	2	–
				186717	ZBH-7 ⁴⁾	2	10
	12, 16	8, 10		548803	ZBV-M5-7	1	3
	12	12		–	M5x14 DIN 912 ³⁾	2	–
				186717	ZBH-7 ⁴⁾	2	10
	16	12		–	M5x16 DIN 912 ³⁾	2	–
				186717	ZBH-7 ⁴⁾	2	10
16	16	–	M5x18 DIN 912 ³⁾	2	–		
		186717	ZBH-7 ⁴⁾	2	10		
20, 25	12, 16	548804	ZBV-M6-9	1	3		
20, 25	20	–	M6x20 DIN 912 ³⁾	2	–		
		150927	ZBH-9 ⁴⁾	2	10		
25	25	–	M6x30 DIN 912 ³⁾	2	–		
		150927	ZBH-9 ⁴⁾	2	10		
HMP/DGSL	HMP	DGSL	HMSV				
	16	16	2	548779	HMSV-49	1	1
	20	16, 20					
	25	20, 25					
	32	25					

- 1) Corrosion resistance class CRC 2 to Festo standard FN 940070
Moderate corrosion stress. Indoor applications in which condensation may occur. External visible parts with primarily decorative requirements for the surface and which are in direct contact with the ambient atmosphere typical for industrial applications.
- 2) Packaging unit quantity
- 3) The screws listed are not included in the scope of delivery of the drives
- 4) The centring sleeves are included in the scope of delivery of the drives

Mini slides DGSL

Accessories

Adapter kit
HAPS, HMSV

Material:
Wrought aluminium alloy
Free of copper and PTFE
RoHS-compliant

 Note
The kit includes the individual mounting interface as well as the necessary mounting material.

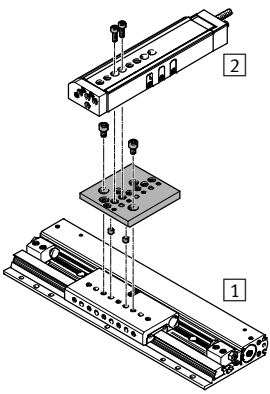
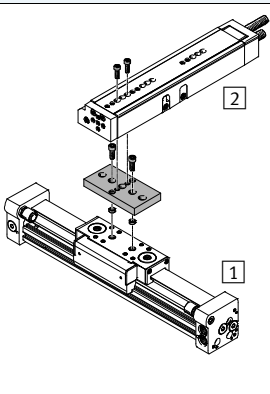
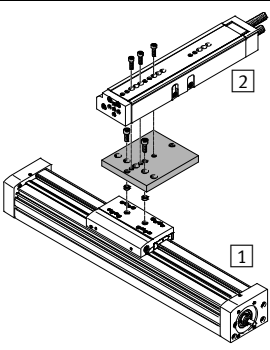
Permissible drive/drive combinations with adapter kit				Download CAD data → www.festo.com			
Combination	1	2	Adapter kit				
	Drive	Drive	CRC ¹⁾	Part No.	Type	Quantity required	PU ²⁾
	SLG	DGSL	HAPS				
	8, 12	4, 6	2	189533	HAPS-11	1	1
	12	8, 10		189534	HAPS-12	1	1
	18	8, 10, 12					
	DGC	DGSL	HMSV				
	8, 12	4, 6	2	548777	HMSV-47	1	1
	18	8, 10		548778	HMSV-48	1	1
	18	12, 16		189657	HMSV-41	1	1
	25	12, 16, 20, 25		548781	HMSV-51	1	1
	32, 40	20, 25		548780	HMSV-50	1	1
	DGE-...	DGSL	HMSV				
	25	12, 16, 20, 25	2	548781	HMSV-51	1	1
	40	20, 25		548780	HMSV-50	1	1

1) Corrosion resistance class CRC 2 to Festo standard FN 940070
Moderate corrosion stress. Indoor applications in which condensation may occur. External visible parts with primarily decorative requirements for the surface and which are in direct contact with the ambient atmosphere typical for industrial applications.

Mini slides DGSL

Accessories

FESTO

Adapter kit
HMSV

Material:
Wrought aluminium alloy
Free of copper and PTFE
RoHS-compliant

 Note
The kit includes the individual mounting interface as well as the necessary mounting material.

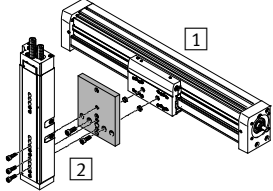
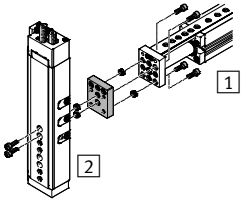
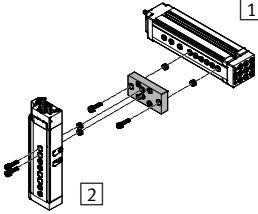
Permissible drive/drive combinations with adapter kit							Download CAD data → www.festo.com	
Combination	1	2	Adapter kit			Quantity required	PU ²⁾	
	Drive	Drive	CRC ¹⁾	Part No.	Type			
EGC/DGSL	EGC	DGSL	HMSV					
	50	4, 6	2	548777	HMSV-47	1	1	
	70	8, 10		548778	HMSV-48	1	1	
	70	12, 16		189657	HMSV-41	1	1	
	80	12, 16, 20, 25		548781	HMSV-51	1	1	
	120	20, 25		548780	HMSV-50	1	1	
EGSL/DGSL	EGSL	DGSL	HMSV					
	35	4, 6, 8, 10	2	1088262	HMSV-70	1	–	
	45, 55	8, 10		548803	ZBV-M5-7	1	3	
	45	12, 16		–	M5x14 DIN 912 ³⁾	2	–	
				186717	ZBH-7 ⁴⁾	2	10	
	55	12, 16		–	M5x12 DIN 912 ³⁾	2	–	
				186717	ZBH-7 ⁴⁾	2	10	
	75	12, 16		548804	ZBV-M6-9	1	3	
75	20	–	M6x20 DIN 912 ³⁾	2	–			
		150927	ZBH-9 ⁴⁾	2	10			
	35	4, 6, 8, 10	2	1088327	HMSV-73	1	–	

- 1) Corrosion resistance class CRC 2 to Festo standard FN 940070
Moderate corrosion stress. Indoor applications in which condensation may occur. External visible parts with primarily decorative requirements for the surface and which are in direct contact with the ambient atmosphere typical for industrial applications.
- 2) Packaging unit quantity
- 3) The screws listed are not included in the scope of delivery of the drives
- 4) The centring sleeves are included in the scope of delivery of the drives