

Linear drives DGC-HD, with heavy-duty guide



Linear drives DGC

Key features

FESTO

At a glance

- New heavy-duty design for:
 - Maximum loads and torques thanks to duo rail guide
 - Long service life
- Ideal as a basic axis for linear gantries and cantilever axes
- In addition to its technical data, the linear drive also offers an excellent price/performance ratio
- Space-saving position sensing with proximity sensor in the profile slot is possible
- Wide range of options for mounting on drives

Guide variants

Compact design DGC-K



- Piston \varnothing 18 ... 80 mm
- Stroke lengths from 1 ... 8500 mm
- 30% narrower than the DGC-G
- Low moving dead weight
- Symmetrical design

Basic design DGC-G



- Piston \varnothing 8 ... 63 mm
- Stroke lengths from 1 ... 8500 mm
- Guide backlash = 0.2 mm
- For small loads
- Operating behaviour with torque load = average

Plain-bearing guide DGC-GF

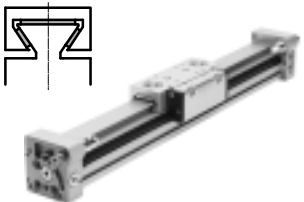

- Piston \varnothing 18 ... 63 mm
- Stroke lengths from 1 ... 8500 mm
- Guide backlash = 0.05 mm
- For small and medium loads
- Operating behaviour with torque load = average

Recirculating ball bearing guide DGC-KF

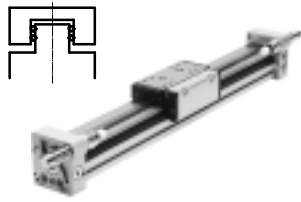

- Piston \varnothing 8 ... 63 mm
- Stroke lengths from 1 ... 8500 mm
- Guide backlash = 0 mm
- For medium and large loads
- Precision mounting interface with stainless steel slide
- Operating behaviour under torque load = very good

Heavy-duty guide DGC-HD

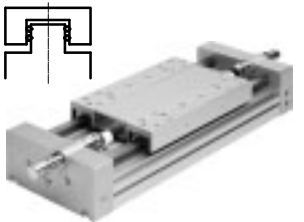

- Piston \varnothing 18, 25, 40 mm
- Stroke lengths from 10 ... 5000 mm
- Guide backlash = 0 mm
- For large loads
- Operating behaviour under torque load = very good

Passive guide axis DGC-FA

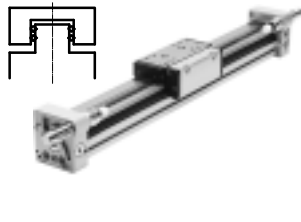

- Without drive
- Piston \varnothing 8 ... 63 mm
- Stroke lengths from 1 ... 8500 mm
- Guide backlash = 0 mm
- Precision guide, suitable for the DGC-KF. Can be used as a machine component or as a twin guide with the DGC-KF

Linear drives DGC

Product range overview

Product variants

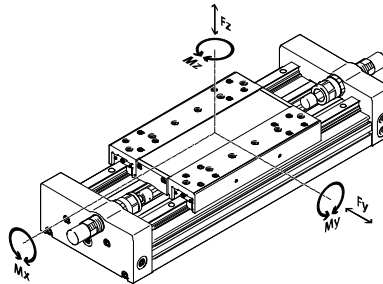

	Piston Ø [mm]	Theoretical force at 6 bar [N]	Guide characteristics					→ Page/ Internet
			Fy [N]	Fz [N]	Mx [Nm]	My [Nm]	Mz [Nm]	
Compact design DGC-K								
	18	153	–	120	0.8	11	1	dgc-k
	25	295	–	330	1.2	20	3	
	32	483	–	480	1.9	40	5	
	40	754	–	800	3.8	60	8	
	50	1178	–	1200	6	120	15	
	63	1870	–	1600	5.7	150	24	
	80	3016	–	2500	30.6	400	100	
Basic design DGC-G								
	8	30	150	150	0.5	2	2	dgc
	12	68	300	300	1.3	5	5	
	18	153	70	340	1.9	12	4	
	25	295	180	540	4	20	5	
	32	483	250	800	9	40	12	
	40	754	370	1100	12	60	25	
	50	1178	480	1600	20	150	37	
	63	1870	650	2000	26	150	48	
Plain-bearing guide DGC-GF								
	18	153	440	540	3.4	20	8.5	dgc
	25	295	640	1300	8.5	40	20	
	32	483	900	1800	15	70	33	
	40	754	1380	2000	28	110	54	
	50	1178	1500	2870	54	270	103	
	63	1870	2300	4460	96	450	187	
Recirculating ball bearing guide DGC-KF								
	8	30	300	300	1.7	4.5	4.5	dgc
	12	68	650	650	3.5	10	10	
	18	153	1850	1850	16	51	51	
	25	295	3050	3050	36	97	97	
	32	483	3310	3310	54	150	150	
	40	754	6890	6890	144	380	380	
	50	1178	6890	6890	144	634	634	
	63	1870	15200	15200	529	1157	1157	
Heavy-duty guide DGC-HD								
	18	153	3650	3650	140	275	275	4
	25	295	5600	5600	300	500	500	
	40	754	13000	13000	900	1450	1450	

Linear drives DGC-HD, with heavy-duty guide

Type codes

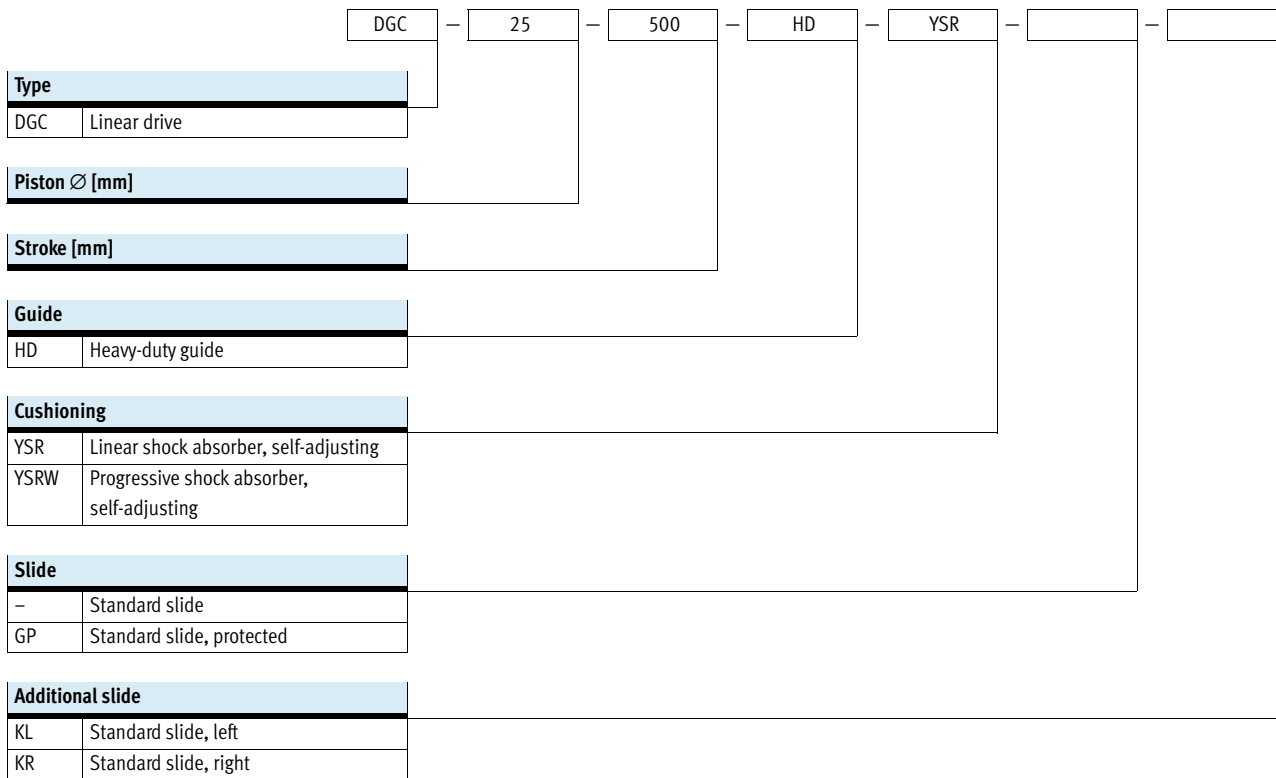

Linear drives DGC-HD, with heavy-duty guide

Type codes



+ ZUB	-	2M				2X		
-------	---	----	--	--	--	----	--	--

Accessories

ZUB	Accessories enclosed separately
-----	---------------------------------

Profile mounting

...M	Profile mounting
------	------------------

Slot cover

...B	For mounting slot
------	-------------------

Slot cover

...S	For sensor slot
------	-----------------

Slot nut

...Y	For mounting slot
------	-------------------

Proximity sensor

...X	(SIES), inductive, slot type 8, PNP, N/O contact, 7.5 m cable
...Z	(SIES), inductive, slot type 8, PNP, N/C contact, 7.5 m cable
...O	(SIEN), inductive, M8, PNP, N/O contact, 2.5 m cable
...P	(SIEN), inductive, M8, PNP, N/C contact, 2.5 m cable
...W	(SIEN), inductive, M8, PNP, N/O contact, plug M8
...R	(SIEN), inductive, M8, PNP, N/C contact, plug M8

Connecting cable

...V	With plug, 2.5 m
------	------------------

Proximity sensor

...I	(SMT), magneto-resistive, N/O contact, 2.5 m cable
...J	(SMT), magneto-resistive, N/O contact, plug M8
...N	(SME), magnetic reed, N/C contact, 7.5 m cable
...G	(SME), magnetic reed, N/O contact, 2.5 m cable
...H	(SME), magnetic reed, N/O contact, plug M8

Linear drives DGC-HD, with heavy-duty guide

Peripherals overview

FESTO

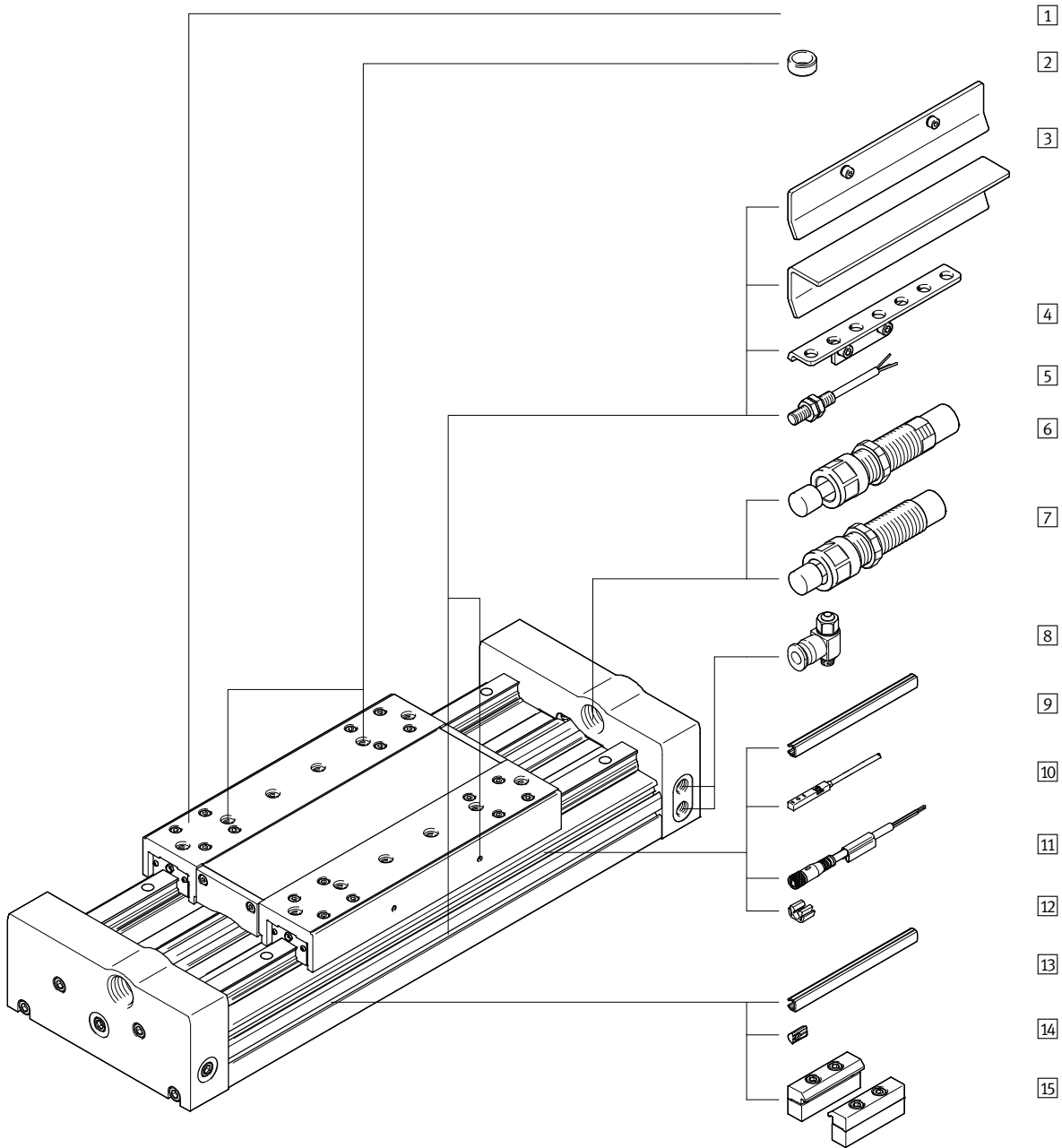

Linear drives DGC-HD, with heavy-duty guide

Peripherals overview

Accessories			
	Type/Order code	Description	→ Page/Internet
1	Linear drive DGC-HD	Pneumatic linear drive with heavy-duty guide	4
2	Centring sleeve ZBH	<ul style="list-style-type: none"> For centring loads and attachments on the slide 2 centring pins/sleeves included in the scope of delivery of the drive 	22
3	Switch lug X, Z, O, P, W, R	For sensing the slide position	20
4	Sensor bracket O, P, W, R	Adapter for mounting the inductive proximity sensors (round design) on the drive	21
5	Proximity sensor, M8 O, P, W, R	<ul style="list-style-type: none"> Inductive, round design The order code O, P, W, R includes 1 switch lug and 2 sensor brackets in the scope of delivery 	23
6	Shock absorber YSR	Linear shock absorber, self-adjusting	19
7	Shock absorber YSRW	Progressive shock absorber, self-adjusting	22
8	One-way flow control valve GRLA	For regulating speed	22
9	Slot cover S	<ul style="list-style-type: none"> For sensor slot For protecting against the ingress of dirt and securing proximity sensor cables 	22
10	Proximity sensor, T-slot X, Z	<ul style="list-style-type: none"> Inductive, for T-slot The order code X, Z includes 1 switch lug in the scope of delivery 	23
10	Proximity sensor, T-slot I, J, N, G, H	Magneto-resistive, magnetic reed, for T-slot	22
11	Connecting cable V	For proximity sensor (order code W and R)	23
12	Clip SMBK	For mounting the proximity sensor cable in the slot	22
13	Slot cover B	For protecting against the ingress of dirt	22
14	Slot nut Y	<ul style="list-style-type: none"> For mounting slot For mounting components 	22
15	Profile mounting M	For mounting the drive on the profile	20

Linear drives DGC-HD, with heavy-duty guide

Technical data

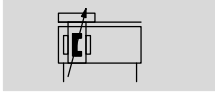

FESTO

Function

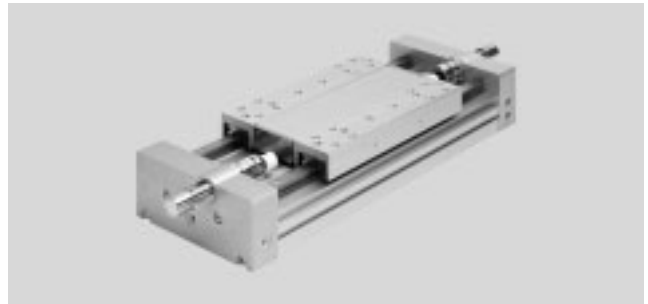

 www.festo.com



-  - Diameter
18 ... 40 mm
-  - Stroke length
10 ... 5000 mm

General technical data			
Piston \varnothing	18	25	40
Design	Pneumatic linear drive with heavy-duty guide		
Guide	Recirculating ball bearing guide		
Mode of operation	Double-acting		
Stroke [mm]	10 ... 3000	10 ... 5000	10 ... 3500
Pneumatic connection	M5	G $\frac{1}{8}$	G $\frac{1}{4}$
Cushioning \rightarrow 11			
DGC-...-YSR	Linear shock absorber, self-adjusting		
DGC-...-YSRW	Progressive shock absorber, self-adjusting		
Max. speed [m/s]	3		
Position sensing	Via proximity sensor		
Type of mounting	Profile mounting		
Mounting position	Any		

Operating and environmental conditions			
Piston \varnothing	18	25	40
Operating pressure [bar]	2.5 ... 8		1.5 ... 8
Operating medium	Compressed air according to ISO 8573-1:2010 [7:-:-]		
Note on operating/pilot medium	Lubricated operation possible (in which case lubricated operation will always be required)		
Ambient temperature ¹⁾ [°C]	-10 ... +60		

1) Note operating range of proximity sensors

Forces [N]			
Piston \varnothing	18	25	40
Theoretical force at 6 bar	153	295	754

Linear drives DGC-HD, with heavy-duty guide

Technical data

Weight [g]			
Piston \varnothing	18	25	40
Basic weight with 0 mm stroke	3987	7509	20469
Additional weight per 10 mm stroke	71	105	199
Moving load	1057	2246	6178

Materials

Sectional view

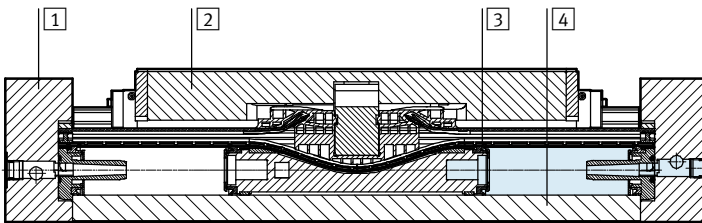

Linear drives		
1	End cap	Anodised aluminium
2	Slide	Anodised aluminium
3	Sealing band/cover band	PU/steel
4	Cylinder barrel	Anodised aluminium
-	Seal	NBR, TPE-U(PU)
Note on materials		RoHS-compliant
		Contains PWIS (paint-wetting impairment substances)

Adjustable end-position range d [mm]

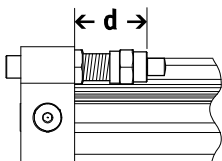

Piston \varnothing	18	25	40
DGC-...-HD	27.3 ... 52.3	31 ... 56	41 ... 76

Linear drives DGC-HD, with heavy-duty guide

Technical data

Characteristic load values

The indicated forces and torques refer to the slide surface. The point of application of force is the point where the centre of the guide and the longitudinal centre of the slide intersect.

These values must not be exceeded during dynamic operation. Special attention must be paid to the cushioning phase.

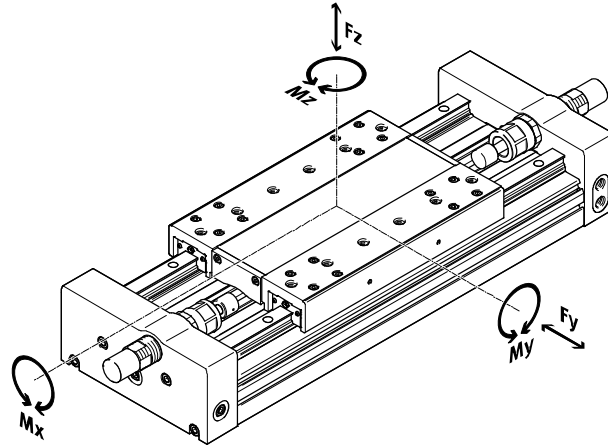

If the drive is simultaneously subjected to several of the indicated forces and torques, the following equation must be satisfied in addition to the indicated maximum loads:

$$\frac{F_y}{F_{y_{max.}}} + \frac{F_z}{F_{z_{max.}}} + \frac{M_x}{M_{x_{max.}}} + \frac{M_y}{M_{y_{max.}}} + \frac{M_z}{M_{z_{max.}}} \leq 1$$

Permissible forces and torques				
Piston Ø		18	25	40
F _{y_{max.}}	[N]	3650	5600	13000
F _{z_{max.}}	[N]	3650	5600	13000
M _{x_{max.}}	[Nm]	140	300	900
M _{y_{max.}}	[Nm]	275	500	1450
M _{z_{max.}}	[Nm]	275	500	1450

Linear drives DGC-HD, with heavy-duty guide

Technical data

Maximum permissible piston speed v as a function of effective load m and distance r_{max} from centre of gravity of load

These specifications represent the maximum values that can be achieved. In practice, values fluctuate relative to the position of the effective load and mounting position.

With YSR cushioning

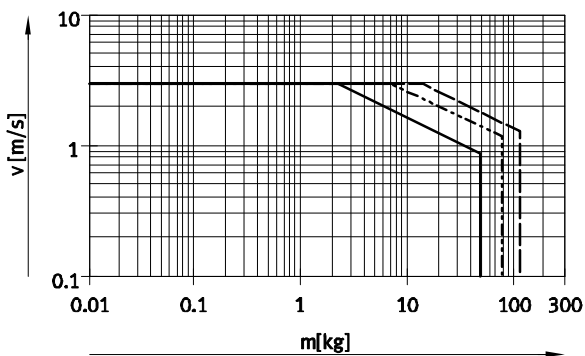

With YSRW cushioning

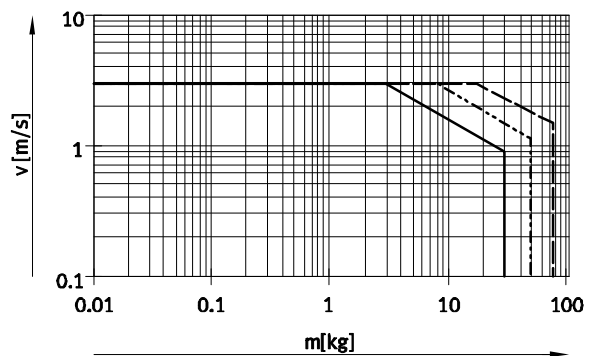

- DGC-18-HD
- DGC-25-HD
- · - · - DGC-40-HD

Working stroke reduction

For standard slide with additional slide KL or KR

- For a linear drive with additional slide, the working stroke is reduced by the length of the additional slide L17 and the distance between both slides L18

- L16 = Length of slide
- L17 = Length of additional slide
- L18 = Distance between both slides

Example:

Type: DGC-25-1000-HD-...-KR
L18 = 100 mm

Working stroke = 1000 mm – 220 mm – 100 mm = 680 mm

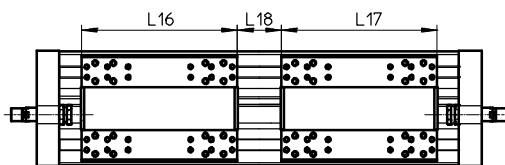

Dimensions – Additional slide

Piston \varnothing	18	25	40
Length L17 [mm]	202	222	302

Linear drives DGC-HD, with heavy-duty guide

Technical data

Number of central supports MUP as a function of force due to weight F and support spacing l

In order to limit deflection in the case of large strokes, the drive may need to be supported. The following graphs

help to determine the maximum permissible support spacing as a

function of mounting position, force due to weight and normal force.

Mounting position
Horizontal

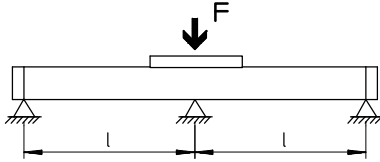

Vertical

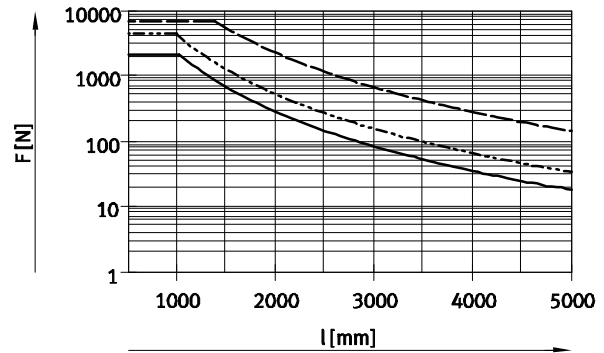
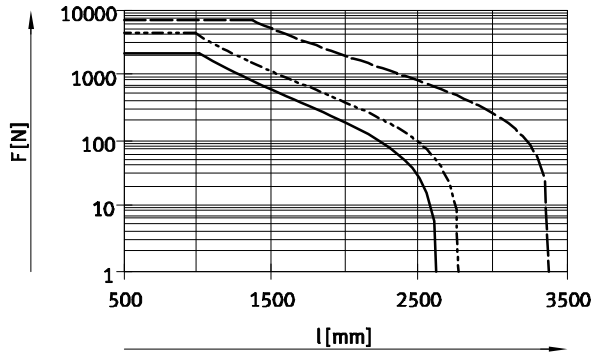
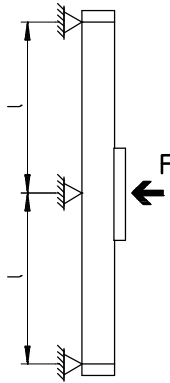

- DGC-18-HD
- - - DGC-25-HD
- · - DGC-40-HD

Example:

The drive DGC-25-1500-HD is subjected to a force of 200 N in a horizontal mounting position.

The drive has an overall length of:

$$\begin{aligned}
 l &= \text{stroke length} + L1 \\
 &\text{(see dimensions)} \\
 &= 1500 \text{ mm} + 351.5 \text{ mm} \\
 &= 1851.5 \text{ mm}
 \end{aligned}$$

According to the graph, the max. support spacing for the drive DGC-25-HD with a force of 200 N is 1800 mm.

In this example, profile mountings are required as the max. support spacing (1800 mm) is smaller than the overall length of the drive (1851.5 mm).

Linear drives DGC-HD, with heavy-duty guide

Technical data

FESTO

Dimensions

Download CAD data → www.festo.com

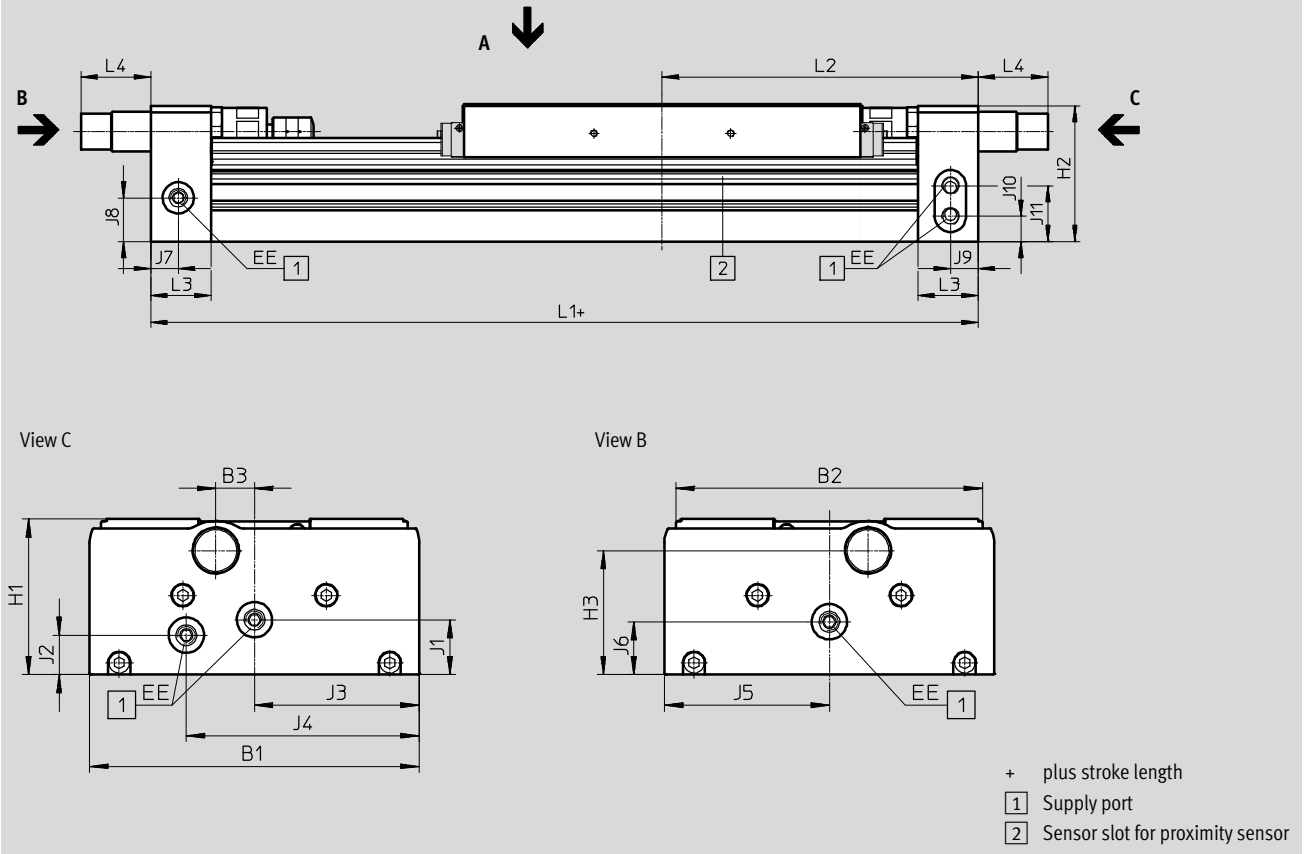

∅	B1	B2	B3	EE	H1	H2	H3
[mm]							
18	124	120	10	M5	64	63.1	51.7
25	162	150.7	19	G ¹ / ₈	76.5	75.5	61
40	222	204	12	G ¹ / ₄	111.5	109.5	91

∅	J1	J2	J3	J4	J5	J6	J7	J8
[mm]								
18	25.5	15	59	88	59	25.5	14.9	21.6
25	27	19.4	81	114.5	81	26	15.4	24.3
40	43	25	105	157	111	37	25.1	31

∅	J9	J10	J11	L1	L2	L3	L4	
							YSR	YSRW
[mm]								
18	14.9	15	25.6	306.5	153	24.5	34	20.5
25	15.4	14	31	351.5	175.5	33.5	43.8	38.8
40	25.1	23	45	472.5	236	44	48.3	38.3

Linear drives DGC-HD, with heavy-duty guide

Technical data

Dimensions

Download CAD data → www.festo.com

Standard slide

Ø 18

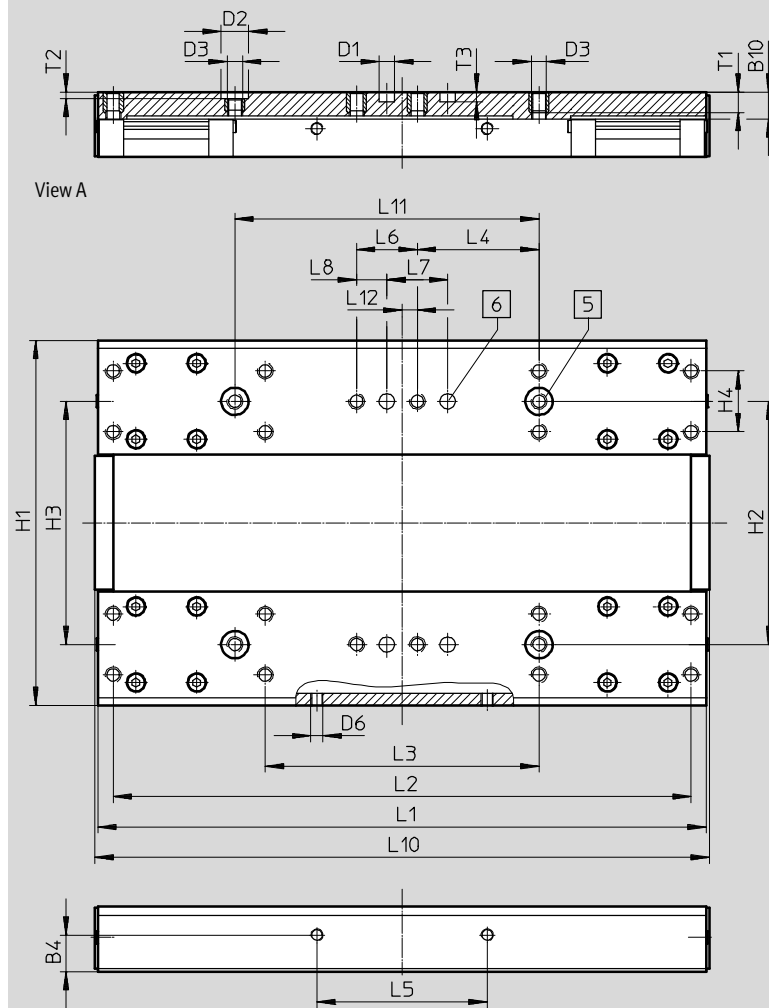

- 5 Hole for centring sleeve ZBH
- 6 Hole for centring pin ZBS

Ø	B4	B10	D1	D2	D3	D6	H1	H2	H3	H4	L1	L2
[mm]	±0.1		Ø H7	Ø H7			±0.3	±0.05		±0.1	±0.1	±0.2
18	12	8.8	5	9	M5	M4	120	80	80	20	200	190

Ø	L3	L4	L5	L6	L7	L8	L10	L11	L12	T1	T2	T3
[mm]	±0.2	±0.1	±0.2	±0.1	±0.03	±0.1		±0.03			+0.1	+0.1
18	90	40	56	20	20	10	202	100	5	7.8	2.1	3.1

Linear drives DGC-HD, with heavy-duty guide

Technical data

FESTO

Dimensions

Download CAD data → www.festo.com

Standard slide/GP – Standard slide, protected

Ø 40

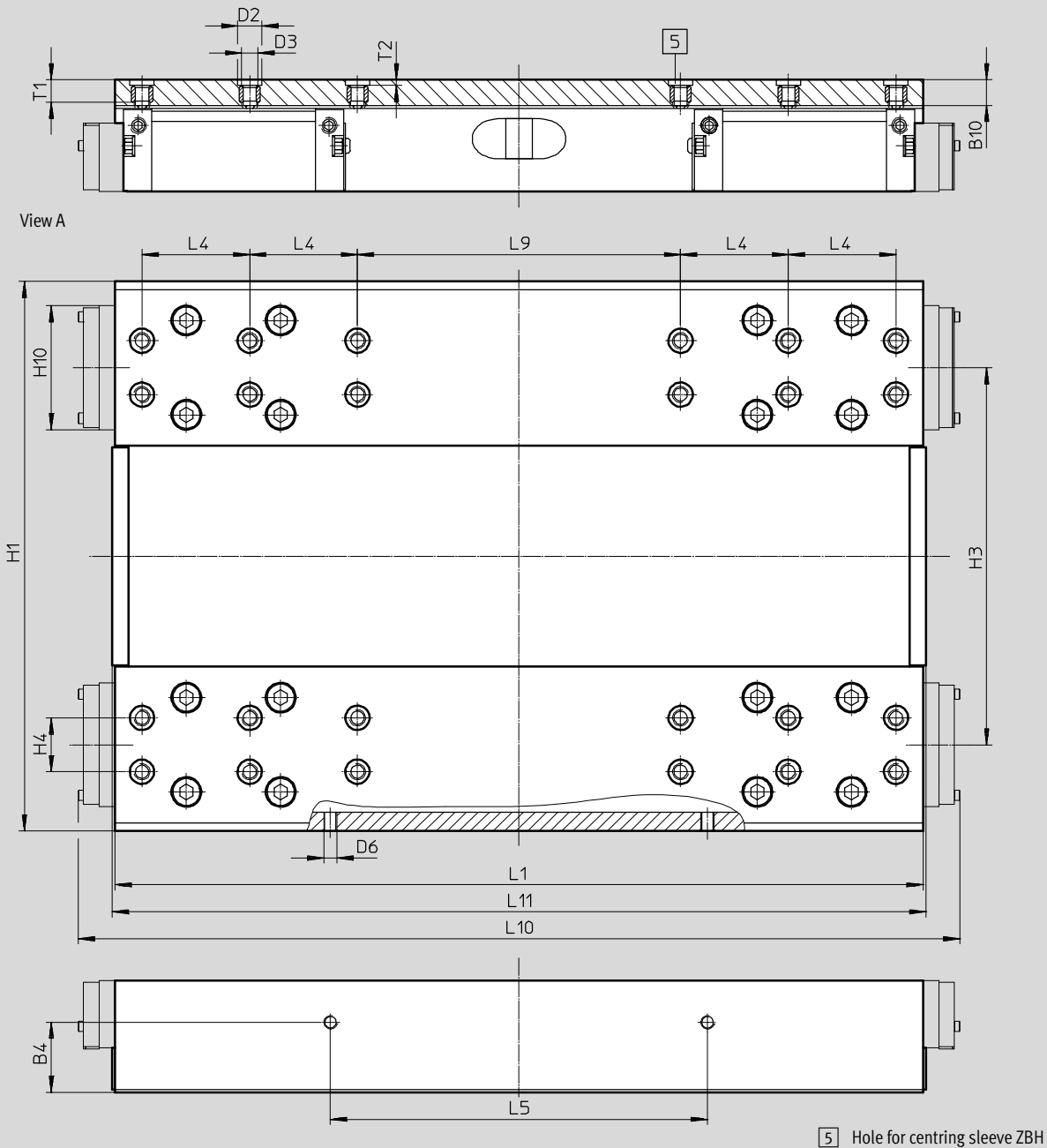

Ø	B4	B10*	D2	D3	D6	H1	H3	H4
[mm]	±0.1		Ø H7			±0.3		±0.05
40	26	10.5	9	M6	M5	204	140	20

Ø	H10*	L1	L4	L5	L9	L10*	L11	T1	T2
[mm]		±0.1	±0.05	±0.1	±0.05				+0.1
40	46	300	40	140	120	327.3	302	9.5	2.1

* Protected version

Linear drives DGC-HD, with heavy-duty guide

Technical data

Dimensions

Download CAD data → www.festo.com

Profile barrel

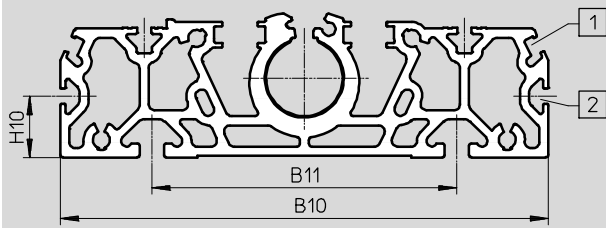

- 1 Sensor slot for proximity sensor
- 2 Mounting slot for slot nut

∅	B10	B11	H10
[mm]			
18	122	80	20
25	160	100	20
40	220	140	20

Linear drives DGC-HD, with heavy-duty guide

Ordering data – Modular products



Order code

Mandatory data

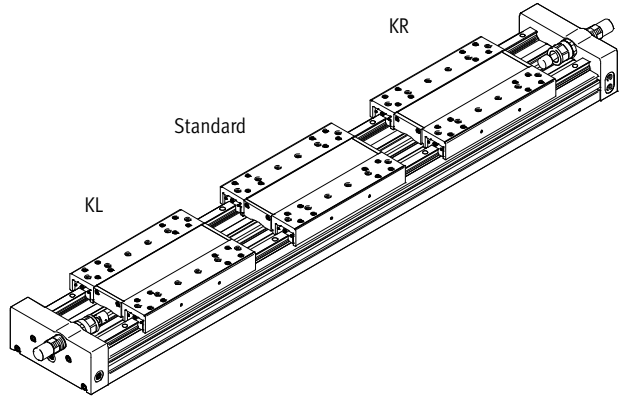
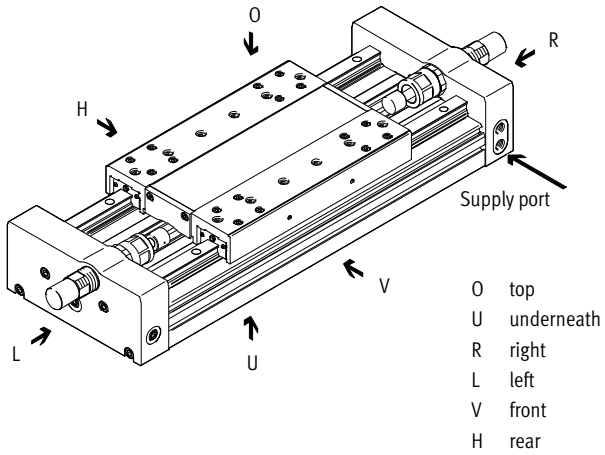

Accessories

- - Note

1) End stops or shock absorbers must not be removed.

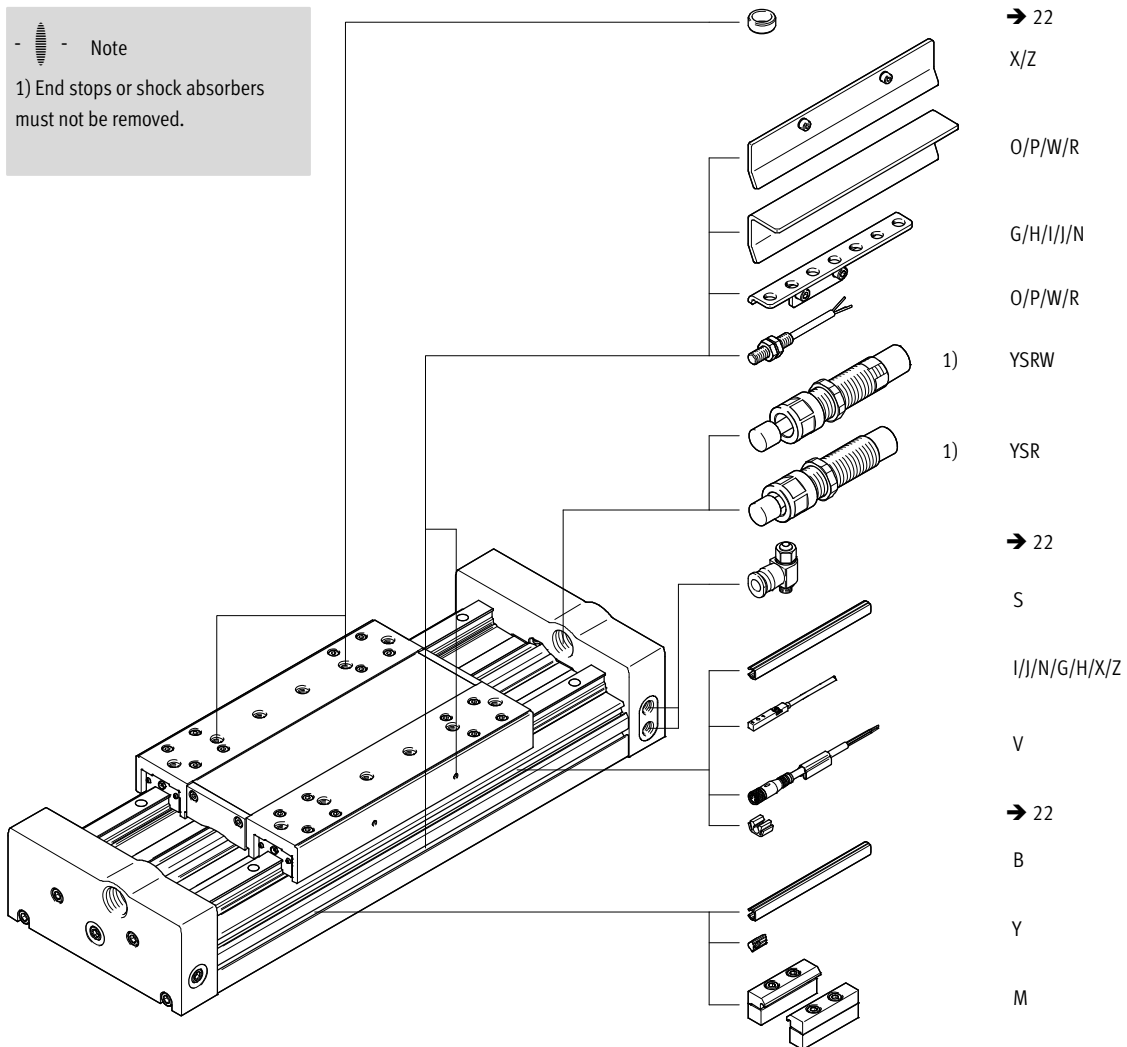

Linear drives DGC-HD, with heavy-duty guide

Ordering data – Modular products

Ordering table						
Piston Ø	18	25	40	Condi- tions	Code	Enter code
M Module No.	567547	567548	567549			
Function	Linear drive				DGC	DGC
Piston Ø [mm]	18	25	40		-...	
Stroke [mm]	10 ... 3000	10 ... 5000	10 ... 3500		-...	
Guide	Heavy-duty guide				-HD	-HD
Cushioning	Shock absorber, self-adjusting				-YSR	
	Progressive shock absorber, self-adjusting				-YSRW	
O Slide	Standard slide					
	-	Standard slide, protected			-GP	
Additional slide	Standard slide, left			1	2	-KL
	Standard slide, right			2		-KR
O Accessories	Enclosed separately				ZUB-	ZUB-
Profile mounting	1 ... 50				...M	
Slot cover for mounting slot	1 ... 50 (1 = 2 units, 500 mm)				...B	
Slot cover for sensor slot	1 ... 50 (1 = 2 units, 500 mm)				...S	
Slot nut for mounting slot	1 ... 99				...Y	
Proximity sensor (SIES), inductive, slot type 8, PNP, incl. switch lug	N/O contact, 7.5 m cable	1 ... 9			...X	
	N/C contact, 7.5 m cable	1 ... 9			...Z	
Proximity sensor (SIEN), inductive, M8, PNP, incl. switch lug and sensor bracket	N/O contact, 2.5 m cable	1 ... 9			...O	
	N/C contact, 2.5 m cable	1 ... 9			...P	
	N/O contact, plug M8	1 ... 9			...W	
	N/C contact, plug M8	1 ... 9			...R	
Connecting cable, M8, 3-wire, 2.5 m	1 ... 9				...V	
Proximity sensor (SMT), magneto-resistive, slot type 8	N/O contact, 2.5 m cable	1 ... 9			...I	
	N/O contact, plug M8	1 ... 9			...J	
Proximity sensor (SME), magnetic reed, slot type 8	N/C contact, 7.5 m cable	1 ... 9			...N	
	N/O contact, 2.5 m cable	1 ... 9			...G	
	N/O contact, plug M8	1 ... 9			...H	

- 1** **KL** Not with additional slide on right KR
- 2** **KL/KR** Not with protected standard slide GP

M Mandatory data
O Options

Transfer order code

DGC - - - **HD** - - - **ZUB**

Linear drives DGC-HD, with heavy-duty guide

Accessories

Profile mounting MUE
(order code M)

Material:
Anodised aluminium
RoHS-compliant

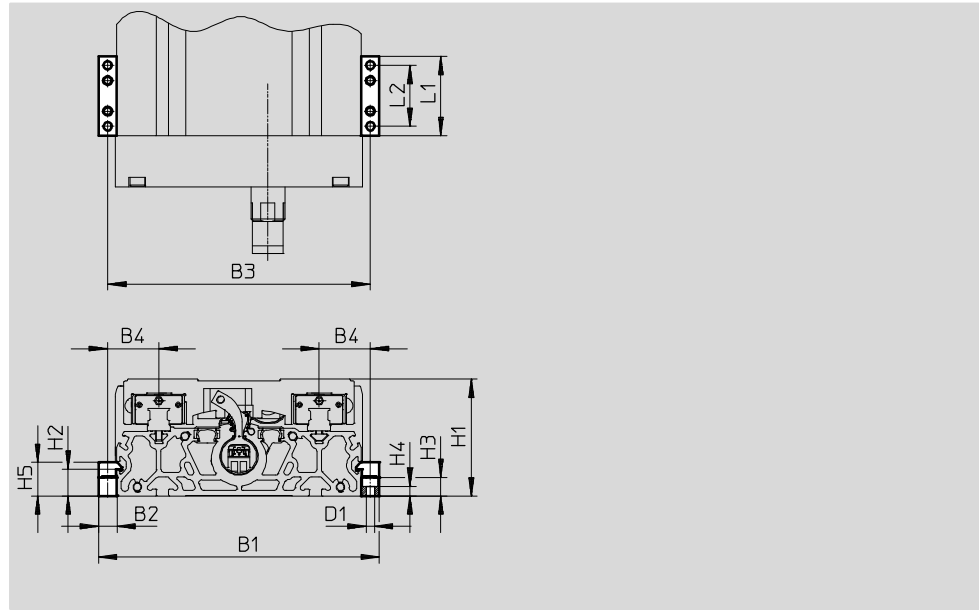
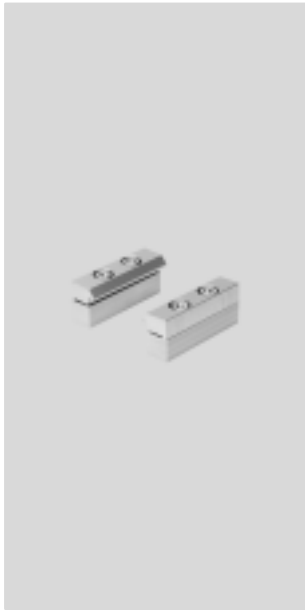

Dimensions and ordering data								
For Ø [mm]	B1	B2	B3	B4	D1 Ø	H1	H2	H3
18	146	12	134	27	5.5	64	17.5	12
25	184	12	172	33.5	5.5	76.5	17.5	12
40	258	19	239	49.5	9	111.5	16	14

For Ø [mm]	H4	H5	L1	L2	Weight [g]	Part No.	Type
18	6.2	22	52	40	80	558043	MUE-70/80
25	6.2	22	52	40	80	558043	MUE-70/80
40	5.5	29.5	90	40	290	558044	MUE-120/185

Switch lug SF-EGC-HD-1
for sensing via proximity sensor
SIES-8M
(order code X or Z)

Material:
Galvanised steel
RoHS-compliant

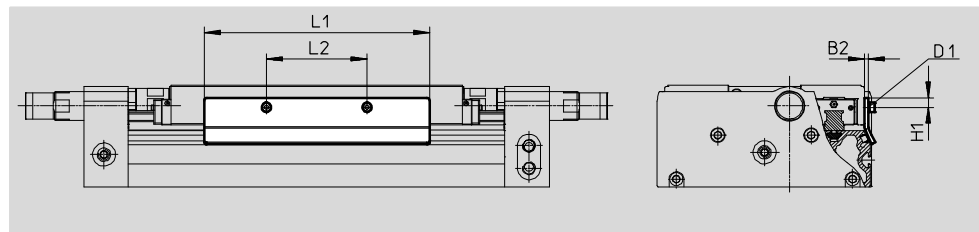

Dimensions and ordering data								
For Ø [mm]	B3	D1	H1	L1	L2	Weight [g]	Part No.	Type
18	2	M4x8	7.8	150	56	70	570027	SF-EGC-HD-1-125
25	3	M4x8	7.3	170	76	160	1645872	SF-EGC-HD-1-160
40	3	M5x10	11.5	250	140	310	1645866	SF-EGC-HD-1-220

Linear drives DGC-HD, with heavy-duty guide

Accessories

Switch lug SF-EGC-HD-2

for sensing via proximity sensor
SIEN-M8B (order code O, P, W or R) or
SIES-8M (order code X or Z)

Material:
Galvanised steel
RoHS-compliant



Sensor bracket HWS-EGC

for proximity sensor SIEN-M8B
(order code O, P, W or R)

Material:
Galvanised steel
RoHS-compliant

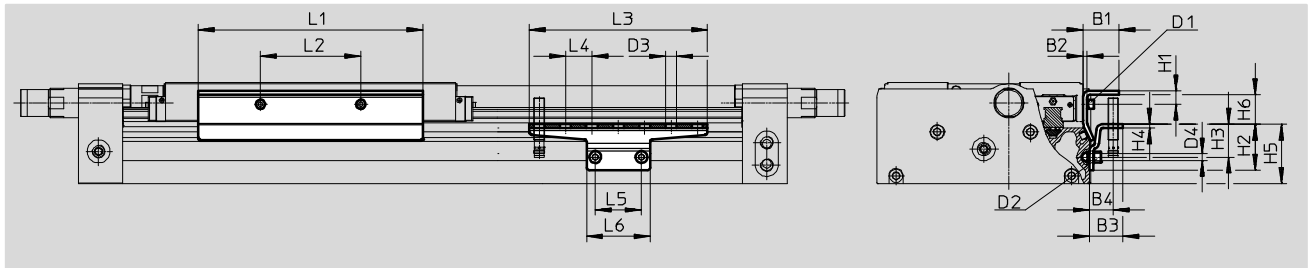

Dimensions and ordering data										
For Ø [mm]	B1	B2	B3	B4	D1	D2	D3 Ø	D4 Ø	H1	H2
18	24	2	25.5	18	M4x8	M5x8	8.4	5.2	9	35
25	27	3	25.5	18	M4x8	M5x8	8.4	5.2	10.3	35
40	31	3	25.5	18	M5x10	M5x14	8.4	5.2	11.5	65

For Ø [mm]	H3	H4	H5	H6	L1	L2	L3	L4	L5	L6
18	25	3	45	14	150	56	135	20	35	48
25	25	3	45	22.2	170	76	135	20	35	48
40	55	3	75	18.4	250	140	215	20	35	48





For Ø [mm]	Weight [g]	Part No.	Type
			Switch lug
18	122	570030	SF-EGC-HD-2-125
25	261	1645865	SF-EGC-HD-2-160
40	430	1645868	SF-EGC-HD-2-220

For Ø [mm]	Weight [g]	Part No.	Type
			Sensor bracket
18	110	558057	HWS-EGC-M5
25	110	558057	HWS-EGC-M5
40	217	570365	HWS-EGC-M8-B

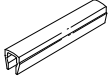

Linear drives DGC-HD, with heavy-duty guide

Accessories

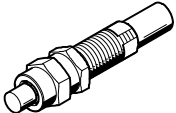
FESTO

Ordering data							
	For Ø	Description	Order code	Part No.	Type	PU ¹⁾	
Slot nut NST Technical data → Internet: hmbn							
	18, 25 ³⁾	For mounting slot	Y	150914	NST-5-M5	1	
	25 ⁴⁾ , 40			150915	NST-8-M6		
Centring pin/sleeve ZBS/ZBH ²⁾							
	18	For slide	-	150928	ZBS-5	10	
	25, 40			150927	ZBH-9		
Slot cover ABP Technical data → Internet: abp							
	18	For mounting slot Every 0.5 m	B	151681	ABP-5	2	
	25			151680	ABP-5-S		
	40			151682	ABP-8		
	18, 25, 40	For sensor slot Every 0.5 m	S	563360	ABP-5-S1	2	
Clip SMBK							
	18 ... 40	For sensor slot, for attaching the proximity sensor cables	-	534254	SMBK-8	10	
One-way flow control valve GRLA Technical data → Internet: grla							
	18	Metal design	-	193137	GRLA-M5-QS-3-D	1	
				193138	GRLA-M5-QS-4-D		
	25			193142	GRLA-1/8-QS-3-D		
				193143	GRLA-1/8-QS-4-D		
	40			193144	GRLA-1/8-QS-6-D		
				193145	GRLA-1/8-QS-8-D		
				193146	GRLA-1/4-QS-6-D		
				193147	GRLA-1/4-QS-8-D		
193148	GRLA-1/4-QS-10-D						
Shock absorber YSRW Technical data → Internet: ysrw							
	18	Self-adjusting, progressive	YSRW	540351	YSRW-DGC-32-KF	1	
	25			1232870	YSRW-DGC-40/50-B		
	40			543069	YSRW-DGC-63		

- 1) Packaging unit
- 2) 2 centring pins/sleeves included in the scope of delivery of the drive
- 3) For mounting slot at side
- 4) For mounting slot underneath





Ordering data – Proximity sensors for T-slot, magneto-resistive							
	Type of mounting	Electrical connection	Switching output	Cable length [m]	Order code	Part No.	Type
N/O contact Technical data → Internet: smt							
	Insertable in the slot from above, flush with the cylinder profile, short design	Cable, 3-wire	PNP	2.5	I	574335	SMT-8M-A-PS-24V-E-2,5-OE
				0.3	J	574334	SMT-8M-A-PS-24V-E-0,3-M8D
		Plug M8x1, 3-pin	NPN	0.3	-	574337	SMT-8M-A-PS-24V-E-0,3-M12
				2.5	-	574338	SMT-8M-A-NS-24V-E-2,5-OE
				0.3	-	574339	SMT-8M-A-NS-24V-E-0,3-M8D
Cable, 3-wire	Plug M8x1, 3-pin	NPN	7.5	-	-	574340	SMT-8M-A-PO-24V-E-7,5-OE
N/C contact							
	Insertable in the slot from above, flush with the cylinder profile, short design	Cable, 3-wire	PNP	7.5	-	574340	SMT-8M-A-PO-24V-E-7,5-OE

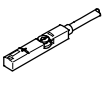
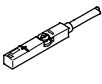

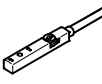
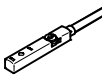
Linear drives DGC-HD, with heavy-duty guide

Accessories

Ordering data – Proximity sensors for T-slot, magnetic reed							Technical data → Internet: sme	
	Type of mounting	Electrical connection	Switching output	Cable length [m]	Order code	Part No.	Type	
N/O contact								
	Insertable in the slot from above, flush with the cylinder profile	Cable, 3-wire	Contacting	2.5	G	543862	SME-8M-DS-24V-K-2,5-OE	
				5.0	–	543863	SME-8M-DS-24V-K-5,0-OE	
		Cable, 2-wire		2.5	–	543872	SME-8M-ZS-24V-K-2,5-OE	
		Plug M8x1, 3-pin		0.3	H	543861	SME-8M-DS-24V-K-0,3-M8D	
N/C contact								
	Insertable in the slot from above, flush with the cylinder profile	Cable, 3-wire	Contacting	7.5	N	546799	SME-8M-DO-24V-K-7,5-OE	

Ordering data – Proximity sensors for T-slot, inductive							Technical data → Internet: sies	
	Type of mounting	Electrical connection	Switching output	Cable length [m]	Order code	Part No.	Type	
N/O contact								
	Insertable in the slot from above, flush with the cylinder profile	Cable, 3-wire	PNP	7.5	X	551386	SIES-8M-PS-24V-K-7,5-OE	
		Plug M8x1, 3-pin		0.3	–	551387	SIES-8M-PS-24V-K-0,3-M8D	
		Cable, 3-wire	NPN	7.5	–	551396	SIES-8M-NS-24V-K-7,5-OE	
		Plug M8x1, 3-pin		0.3	–	551397	SIES-8M-NS-24V-K-0,3-M8D	
N/C contact								
	Insertable in the slot from above, flush with the cylinder profile	Cable, 3-wire	PNP	7.5	Z	551391	SIES-8M-PO-24V-K-7,5-OE	
	Plug M8x1, 3-pin	0.3		–	551392	SIES-8M-PO-24V-K-0,3-M8D		
		Cable, 3-wire	NPN	7.5	–	551401	SIES-8M-NO-24V-K-7,5-OE	
	Plug M8x1, 3-pin	0.3		–	551402	SIES-8M-NO-24V-K-0,3-M8D		

Ordering data – Proximity sensors M8 (round design), inductive							Technical data → Internet: sien	
	Electrical connection	LED	Switching output	Cable length [m]	Order code	Part No.	Type	
N/O contact								
	Cable, 3-wire	■	PNP	2.5	O	150386	SIEN-M8B-PS-K-L	
	Plug M8x1, 3-pin	■	PNP	–	W	150387	SIEN-M8B-PS-S-L	
N/C contact								
	Cable, 3-wire	■	PNP	2.5	P	150390	SIEN-M8B-PO-K-L	
	Plug M8x1, 3-pin	■	PNP	–	R	150391	SIEN-M8B-PO-S-L	

Ordering data – Connecting cables					Technical data → Internet: nebu	
	Electrical connection, left	Electrical connection, right	Cable length [m]	Part No.	Type	
	Straight socket, M8x1, 3-pin	Cable, open end, 3-wire	2.5	541333	NEBU-M8G3-K-2.5-LE3	
			5	541334	NEBU-M8G3-K-5-LE3	
	Straight socket, M12x1, 5-pin	Cable, open end, 3-wire	2.5	541363	NEBU-M12G5-K-2.5-LE3	
			5	541364	NEBU-M12G5-K-5-LE3	
	Angled socket, M8x1, 3-pin	Cable, open end, 3-wire	2.5	541338	NEBU-M8W3-K-2.5-LE3	
			5	541341	NEBU-M8W3-K-5-LE3	
	Angled socket, M12x1, 5-pin	Cable, open end, 3-wire	2.5	541367	NEBU-M12W5-K-2.5-LE3	
			5	541370	NEBU-M12W5-K-5-LE3	