

Control blocks CPX-CEC-...-V3



Control blocks CPX-CEC-...-V3

Key features



Application Controller



The control blocks CPX-CEC-...-V3 are modern control systems for CPX terminals that enable programming with CODESYS to IEC 61131-3.

Programming in a global language

CODESYS V3 provided by Festo offers a convenient user interface with the following functions:

- Integrated module libraries
- Library Manager for integrating further libraries
- Visualisation editor

- Simulation mode
- Integrated project documentation
- Debugging functions for fault finding
- Configuration and parameterisation of the controller using the control configuration
- Object-oriented programming

Basic functions

The control blocks CPX-CEC-...-V3 offer the following basic functions:

- Programming with CODESYS to IEC 61131-3
- Communication via Ethernet (Modbus/TCP, EasyIP, TCP/IP)
- Process visualisation using operator unit CDPX or OPC server
- Communication via fieldbus in combination with a fieldbus node in the CPX terminal
- Diagnostics and quick commissioning of CPX modules via handheld CPX-MMI

CPX-CEC-C1-V3 offers

- All basic functions
- CANopen master for controlling up to 127 CANopen stations. Electric axes can be controlled in point-to-point mode

CPX-CEC-M1-V3 offers

- All basic functions
- CANopen master for controlling up to eight electric axes (recommended) in interpolated mode (two of these axes with circular interpolation and six additionally with linear interpolation)
- SoftMotion function library for coordinated multi-axis movements

CPX-CEC-S1-V3 offers

- All basic functions
- RS232 interface for operating external devices

Note
When using external devices, data communication must be programmed by the user.

Bus connection

The control blocks CPX-CEC-...-V3 are remote controllers that can be connected to a higher-order PLC via the fieldbus nodes of the CPX terminal or via Ethernet, for example:

- PROFINET
- EtherNet/IP
- EtherCAT
- PROFIBUS
- DeviceNet

Operating modes

- Stand-alone
- Remote controller on the fieldbus
- Remote controller on Ethernet

System expansion

CANopen connects CPX-CEC with valve terminals and electric drive controllers from Festo:

- CPX, CPV
- CMMP-AS, CMMS-AS/-ST, etc.
- AS-Interface gateway

Ethernet connects CPX-CEC with additional controllers and operator units from Festo:

- CECX
- CDPX
- Camera SBO...-Q

System expansion (examples)

CPX-CEC as a stand-alone or remote controller

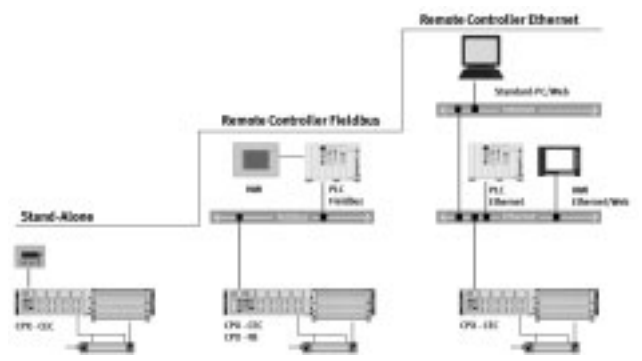

CPX-CEC-C1 as a CANopen fieldbus master

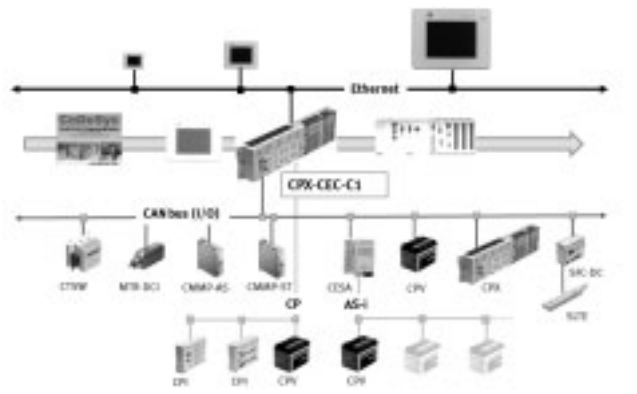

Control blocks CPX-CEC-...-V3

Key features

Advantages for users

Increased performance

Improved cycle times – more connectable actuators. Compatibility with almost all control systems on the market is ensured via the CPX terminal.

The extensive CODESYS function library provides diagnostics and condition monitoring options.

Reduced costs

For standardised pre-processing: reduces installation costs as an intelligent remote I/O terminal to IP65/IP67 directly at the machine.

The control blocks CPX-CEC-...-V3 are ideally adapted to CPX and motion applications with up to 127 axes.

Simple, yet efficient: decentralised structures

The modular I/O system with up to 512 I/Os and CAN master functionality offers complete flexibility, whether for open-loop or closed-loop control.

Stand-alone for low-cost automation of manual workstations, for example, or remote control with pre-processing.

The only one in the world to IP65

The fully integrated automation platform for standard, proportional and servopneumatics, sensors and motion control to IP65.

Simple commissioning is also included.

Classification of CPX-CEC in the portfolio for multi-axis controllers for electric drive technology

Compact controller CECC

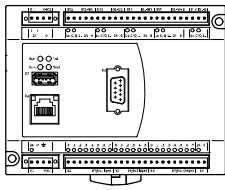

Compact and with more functions. For controlling electric and pneumatic drives for small tasks. Stand-alone or in mechatronic solutions via CODESYS V3 provided by Festo.

Integrated controller in CDPX

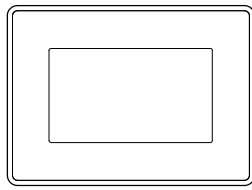

Display generation with integrated controller with CODESYS V3 provided by Festo, powerful processors, combined with widescreen technology for greater functionality, higher resolution and versatile access options.

Integrated control blocks in CPX terminal: CPX-CEC

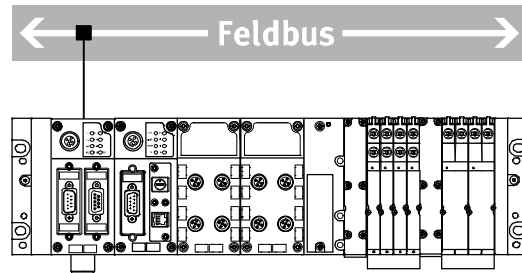

CODESYS V3 provided by Festo for the best valve/sensor terminal on the market: CPX-CEC reduces installation costs as an intelligent remote system to IP65/IP67 directly at the machine.

Ideal for CPX terminal and motion applications with up to 127 electric drives, PTP and SoftMotion applications up to 3D plus auxiliary axes.

Control blocks CPX-CEC-...-V3

Type codes

		CPX	—	CEC	—	C1	—	V3
Type								
CPX		Modular electrical terminal						
Electrical actuation								
CEC		Control block						
Interface and function								
C1		CANOpen						
M1		CANopen, SoftMotion						
S1		RS232						
Parameterisation								
V3		CODESYS V3						

Control blocks CPX-CEC-...-V3

Technical data

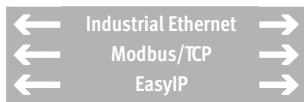

IT services:



The CODESYS controller is a modern control system for CPX terminals that enables programming with CODESYS to IEC 61131-3.

The power supply to and communication with other modules takes place via the interlinking block.

In addition to network connections, LEDs are also provided for the bus status, operating status of the PLC and CPX peripherals information, as are switching elements and a diagnostic interface for CPX-MMI and CPX-FMT.

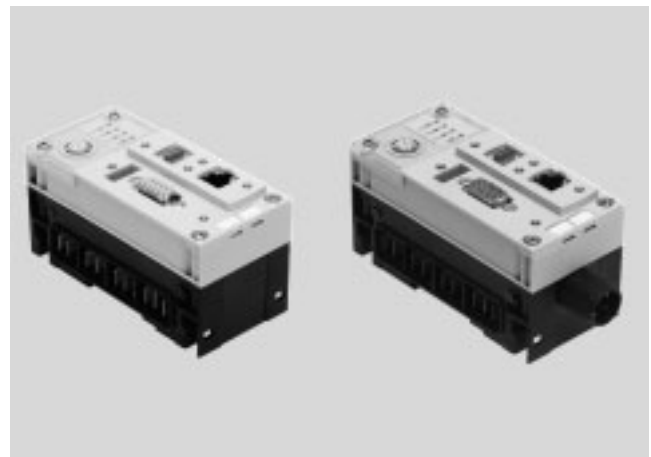

Application			
Bus connection		Communication protocols	Operating modes
The CPX-CEC is a remote controller that can be connected to a master PLC via the fieldbus nodes of the CPX terminal or via Ethernet. At the same	time, it is possible to operate the CPX-CEC as a compact stand-alone controller directly on the machine.	<ul style="list-style-type: none"> Fieldbus via CPX fieldbus nodes Modbus/TCP EasyIP 	<ul style="list-style-type: none"> Stand-alone Remote controller, fieldbus Remote controller, Ethernet
Setting options			
The CPX-CEC has the following interfaces for monitoring, programming and commissioning:	<ul style="list-style-type: none"> For the CPX-MMI/-FMT Ethernet interface for IT applications Remote diagnostics 	The operating mode and fieldbus protocol are set using the DIL switch on the CPX-CEC.	The integrated web server offers a convenient means of querying data saved in the CPX-CEC.
Features			
<ul style="list-style-type: none"> Easy actuation of valve terminal configurations with MPA, VTSA Diagnostics with flexible monitoring options for pressure, flow rate, cylinder operating time, air consumption 	<ul style="list-style-type: none"> Actuation of decentralised installation systems on the basis of CPI actuation of applications in proportional pneumatics AS-Interface actuation via gateway Connection to all fieldbuses as a 	<ul style="list-style-type: none"> remote controller and for pre-processing Actuation of electric drives as individual axes via CANopen (CPX-CEC-C1-V3 and CPX-CEC-M1-V3) 	<ul style="list-style-type: none"> Early warnings and visualisation options Closed-loop pneumatic applications

Control blocks CPX-CEC

Technical data

General technical data		
Protocol		CODESYS Level 2
		EasyIP
		Modbus TCP
		TCP/IP
Processing time		Approx. 200 µs/1 k instruction
Programming software		CODESYS provided by Festo
Programming language		To IEC 61131-3
		Sequential function chart (SFC)
		Instruction list (IL)
		Function chart (FCH), additional continuous function chart (CFC)
		Ladder diagram (LD)
Programming	Operating language	German, English
	Support for file handling	Yes
Device-specific diagnostics		Diagnostic memory
		Channel and module-oriented diagnostics
		Undervoltage/short circuit of modules
LED displays	Bus-specific	TP: Link/traffic
	Product-specific	RUN: PLC status
		STOP: PLC status
		ERR: PLC runtime error
		PS: Electronics supply, sensor supply
		PL: Load supply
		SF: System fault
M: Modify/forcing active		
IP address setting		DHCP
		Via CODESYS
		Via MMI
Function blocks		CPX diagnostic status, copy CPX diagnostic trace, read CPX module diagnostics, etc.
Dimensions (incl. interlinking block) W x L x H	[mm]	50 x 107 x 55
Product weight	[g]	135

Materials		
Housing		Reinforced PA
		PC
Note on materials		RoHS-compliant

Operating and environmental conditions		
Ambient temperature	[°C]	-5 ... +50
Storage temperature	[°C]	-20 ... +70
Relative air humidity	[%]	95, non-condensing
Corrosion resistance class CRC ¹⁾		2

1) Corrosion resistance class CRC 2 to Festo standard FN 940070
Moderate corrosion stress. Indoor applications in which condensation may occur. External visible parts with primarily decorative requirements for the surface and which are in direct contact with the ambient atmosphere typical for industrial applications.

Control blocks CPX-CEC-...-V3

Technical data

Electrical data			
Nominal operating voltage	[V DC]		24
Load voltage	Nominal operating voltage	[V DC]	24
	With pneumatics type CPA	[V DC]	20.4 ... 26.4
	With pneumatics type MPA	[V DC]	18 ... 30
	Without pneumatics	[V DC]	18 ... 30
Power failure buffering	[ms]		10
Intrinsic current consumption at nominal operating voltage	[mA]		Typically 85
Degree of protection to EN 60529			IP65, IP67

Technical data					
Type			CPX-CEC-S1-V3	CPX-CEC-C1-V3	CPX-CEC-M1-V3
Additional functions	Diagnostic functions				
			RS232 communication function	Motion functions for electric drives	SoftMotion functions for electric drives
CPU data	Flash	[MB]	32	32	32
	RAM	[MB]	256	256	256
	Processor	[MHz]	800	800	800
Control interface			–	CAN bus	CAN bus
Parameterisation			CODESYS V3	CODESYS V3	CODESYS V3
Configuration support			CODESYS V3	CODESYS V3	CODESYS V3
Program memory, user program		[MB]	16	16	16
Flags	CODESYS variable concept				
	Remanent data	[kB]	28	28	28
Control elements			–	DIL switch for CAN termination	
			Rotary switch for RUN/STOP	Rotary switch for RUN/STOP	
Total number of axes			–	127	31
Ethernet	Number		1		
	Connection technology		RJ45 socket, 8-pin		
	Data transmission speed	[Mbps]	10/100		
	Supported protocols		TCP/IP, EasyIP, Modbus TCP		
Fieldbus interface	Number		–	1	
	Connection technology		–	Sub-D plug connector, 9-pin	
	Data transmission speed, can be set via software	[kbps]	–	125, 250, 500, 800, 1000	125, 250, 500, 800, 1000
	Supported protocols		–	CAN bus	
	Galvanic isolation		–	Yes	
Data interface	Number		1		
	Connection technology		Sub-D socket, 9-pin		
	Data transmission speed, can be set via software	[kbps]	9.6 ... 230.4		
	Supported protocols		RS232 interface		
	Max. cable length	[m]	30		
	Galvanic isolation		Yes		

Control blocks CPX-CEC-...-V3

Technical data

Connection and display components CPX-CEC-C1-V3, CPX-CEC-M1-V3

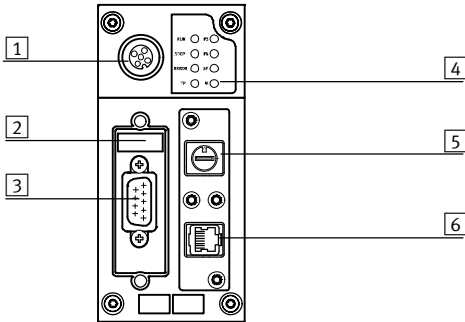

- 1 CPX-MMI connection
- 2 DIL switch
- 3 Fieldbus interface
(Sub-D plug connector, 9-pin)
- 4 Status LEDs, bus-specific and product-specific
- 5 RUN/STOP rotary switch
- 6 Ethernet interface (RJ45 socket, 8-pin)

Pin allocation – CPX-CEC-C1-V3, CPX-CEC-M1-V3

	Pin	Signal	Meaning
Fieldbus interface, Sub-D plug connector			
	1	n.c.	Not connected
	2	CAN_L	CAN low
	3	CAN_GND	CAN ground
	4	n.c.	Not connected
	5	CAN_SHLD	Connection to functional earth FE
	6	CAN_GND	CAN ground (optional) ¹⁾
	7	CAN_H	CAN high
	8	n.c.	Not connected
	9	n.c.	Not connected
	Housing	Screening	Plug connector housing must be connected to FE
Ethernet interface, RJ45 plug connector			
	1	TD+	Transmitted data+
	2	TD-	Transmitted data-
	3	RD+	Received data+
	4	n.c.	Not connected
	5	n.c.	Not connected
	6	RD-	Received data-
	7	n.c.	Not connected
	8	n.c.	Not connected
Housing	Screening	Screening	

1) If a drive controller with external power supply is connected, CAN ground (optional), pin 6, on the CPX-CEC-C1-V3 and CPX-CEC-M1-V3 must not be used.

Control blocks CPX-CEC-...-V3

Technical data

Connection and display components CPX-CEC-S1-V3

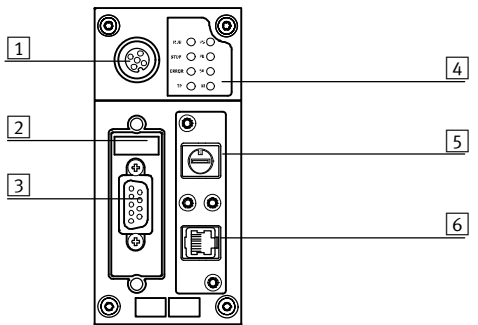







- 1 CPX-MMI connection
- 2 DIL switch
- 3 RS232 interface
(Sub-D socket, 9-pin)
- 4 Status LEDs, bus-specific and
product-specific
- 5 RUN/STOP rotary switch
- 6 Ethernet interface (RJ45 socket,
8-pin)

Pin allocation – CPX-CEC-S1-V3

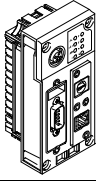
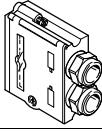
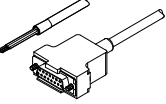
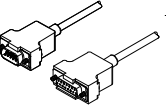
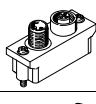
	Pin	Signal	Meaning
Fieldbus interface, Sub-D socket			
	1	n.c.	Not connected
	2	RXD	Received data
	3	TXD	Transmitted data
	4	n.c.	Not connected
	5	GND	Data reference potential
	6	n.c.	Not connected
	7	n.c.	Not connected
	8	n.c.	Not connected
	9	n.c.	Not connected
	Screening	Screening	Connection to functional earth
Ethernet interface, RJ45 plug connector			
	1	TD+	Transmitted data+
	2	TD-	Transmitted data-
	3	RD+	Received data+
	4	n.c.	Not connected
	5	n.c.	Not connected
	6	RD-	Received data-
	7	n.c.	Not connected
	8	n.c.	Not connected
Housing	Screening	Screening	

Control blocks CPX-CEC-...-V3

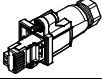
Accessories

Ordering data			
Designation		Part No.	Type
Control block			
	Motion functions for electric drives	3473128	CPX-CEC-C1-V3
	SoftMotion functions for electric drives	3472765	CPX-CEC-M1-V3
	RS232 communication function	3472425	CPX-CEC-S1-V3
Fieldbus interface			
	Sub-D plug connector, 9-pin, for CANopen	532219	FBS-SUB-9-BU-2x5POL-B
	Connecting cable FED	539642	FEC-KBG7
	Connecting cable FED	539643	FEC-KBG8
	Micro Style bus connection, 2xM12 for DeviceNet/CANopen	525632	FBA-2-M12-5POL
	Socket for Micro Style connection, M12	18324	FBSD-GD-9-5POL
	Plug connector for Micro Style connection, M12	175380	FBS-M12-5GS-PG9
	Open Style bus connection for 5-pin terminal strip for DeviceNet/CANopen	525634	FBA-1-SL-5POL
	Terminal strip for Open Style connection, 5-pin	525635	FBSD-KL-2x5POL
Ethernet interface			
	RJ45 plug connector	534494	FBS-RJ45-8-GS
	Cover for RJ45 connection	534496	AK-Rj45

Control blocks CPX-CEC-...-V3

Accessories

FESTO

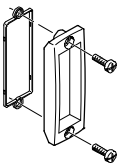
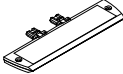
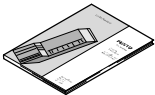
Ordering data			
Designation		Part No.	Type
Covers and attachments			
	Inspection cover, transparent, for Sub-D connection	533334	AK-SUB-9/15-B
	Inscription label holder for manifold block	536593	CPX-ST-1
User documentation			
	Manual for control block CPX-CEC	German	569121 P.BE-CPX-CEC-DE
		English	569122 P.BE-CPX-CEC-EN