

CPI installation system

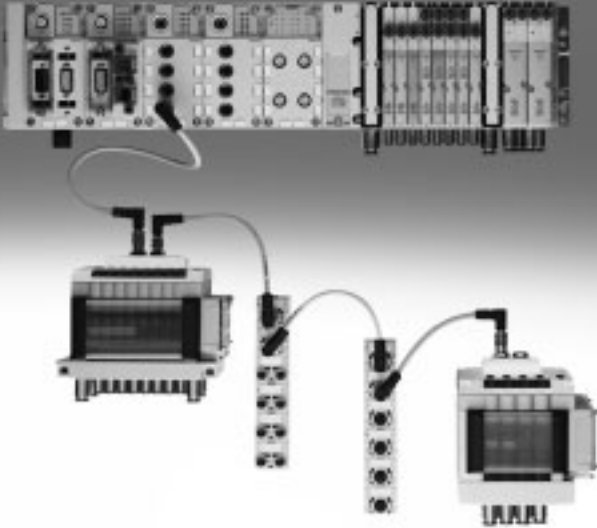

CPI installation system

Key features

FESTO

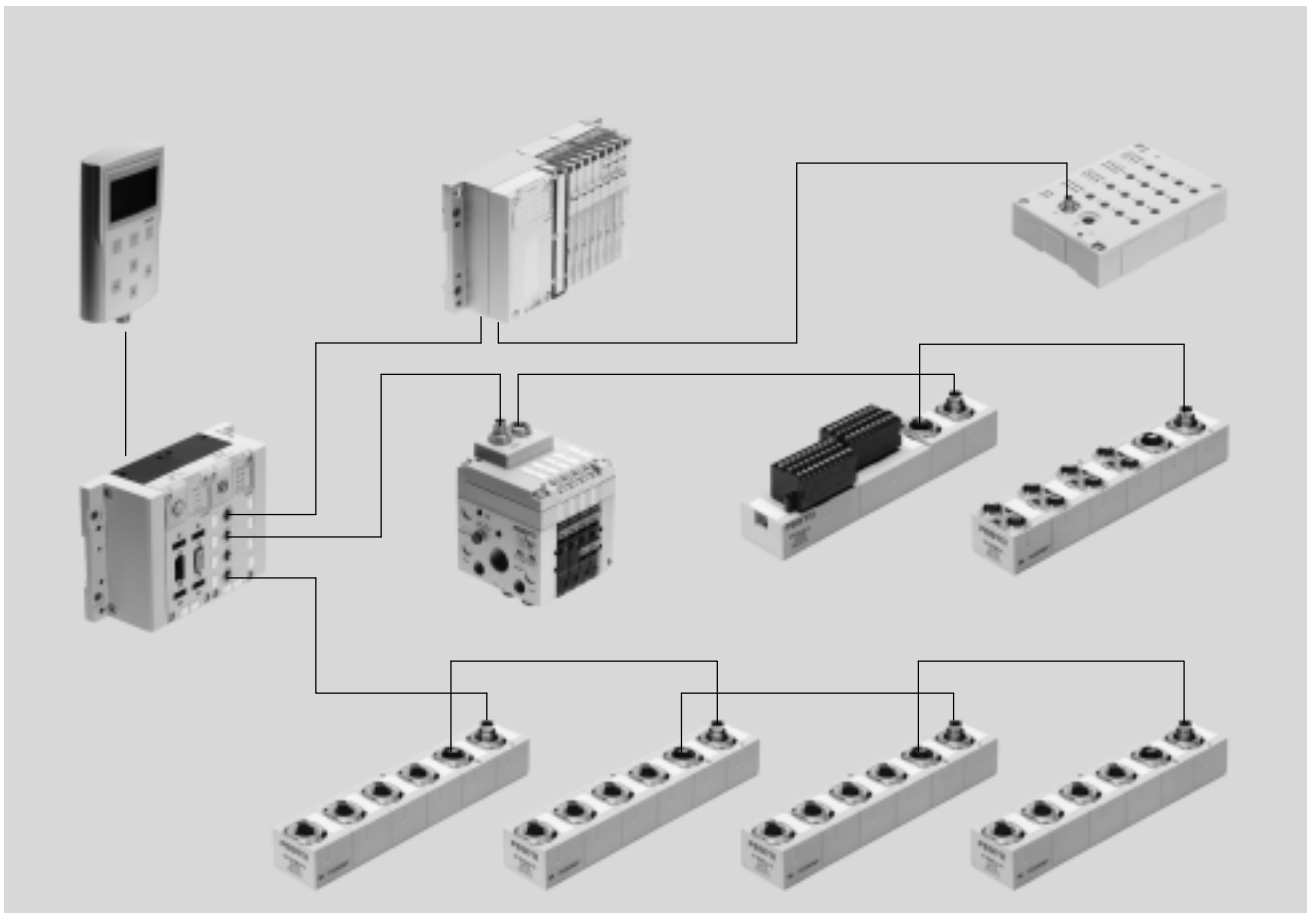

Key features

Innovative	Sturdy	Versatile	Reliable
<ul style="list-style-type: none"> • Complete concept for decentralised machine and system structure; centralised and decentralised installation can be combined with the CPX terminal • Decentralised pneumatics and sensors for fast processes • Centralised electrics for fieldbus and common power supply • Flexible configuration of the individual CP strings • Selectable valve terminal sizes for optimum pneumatic control loop systems • Performance data as for the CP system with the addition of the comprehensive diagnostic capabilities of the CPX terminal 	<ul style="list-style-type: none"> • Electrical accessories to IP65 • Proven valve terminals CPV (compact), MPA-S (sturdy, modular), CPV-SC (small, compact) • Electrical input and output modules in metal housing or compact in encapsulated plastic housing • Sturdy connection technology M12, alternatively M8 • IP20 modules for control cabinet installation with spring-loaded terminals or screw terminals 	<ul style="list-style-type: none"> • A number of CP interfaces can be combined under one fieldbus node • Four CP strings up to 10 m in length (radius) facilitate optimum decentralisation • Max. 32 inputs and 32 outputs/valves per string • Available valves: <ul style="list-style-type: none"> – Valve terminal MPA-S, flow rate max. 700 l/min – Valve terminal CPV, flow rate max. 1600 l/min – Valve terminal CPV-SC, flow rate max. 170 l/min • Input modules with 8 ... 32 inputs and output modules with 4 ... 8 outputs, each with or without additional power supply • Universal electrical outputs 	<ul style="list-style-type: none"> • Sturdy modules and accessories • Ready to install system including CP cable (hybrid cable for data and power) • Polarity-safe and short circuit proof connections • Valves with separate load voltage supply • All modules equipped with local diagnostics and status LEDs • Diagnostics of each CP string via controller/fieldbus • Intelligent system (save button) "learns" current configuration • Easy replacement of modules at any time

CPI installation system

Key features

CPI installation system

The CPI system is capable of meeting two completely different requirements and resolves the conflict between extensive decentralised modularisation and electrical installation.

High-speed machines require short cycle times and short pneumatic tubing. The valves must be mounted close to the cylinders. The CPI system was developed to meet these requirements without having to wire each valve individually.

The system integrates the modular valve terminals CPV and various input/output modules in a single installation concept.

All CP valve terminals and CP modules are connected using a ready to install CP cable, and are attached to the CP interface. Four modules, for example one CPV valve terminal and one to three CP input modules, make up an installation string that ends at the CP interface.

Scope of features:

- Max. 4 installation strings per CP interface
- Max. 10 metre line length per string (radius)
- Max. 4 CP modules per string
- Max. 32 inputs and max. 32 outputs per string

The number of CP modules that can be connected and the number of inputs/outputs is dependent on the type of CP

module and CP interface. The maximum configuration (4 modules per string, 32 inputs/outputs) is only possible in combination with the CPX terminal and CP modules with CPI functionality.

The CP interface is the central connection point for the valve power supply and the sensor supply. The power supply for the sensors connected to the input modules is separate from the load voltage of the valves.

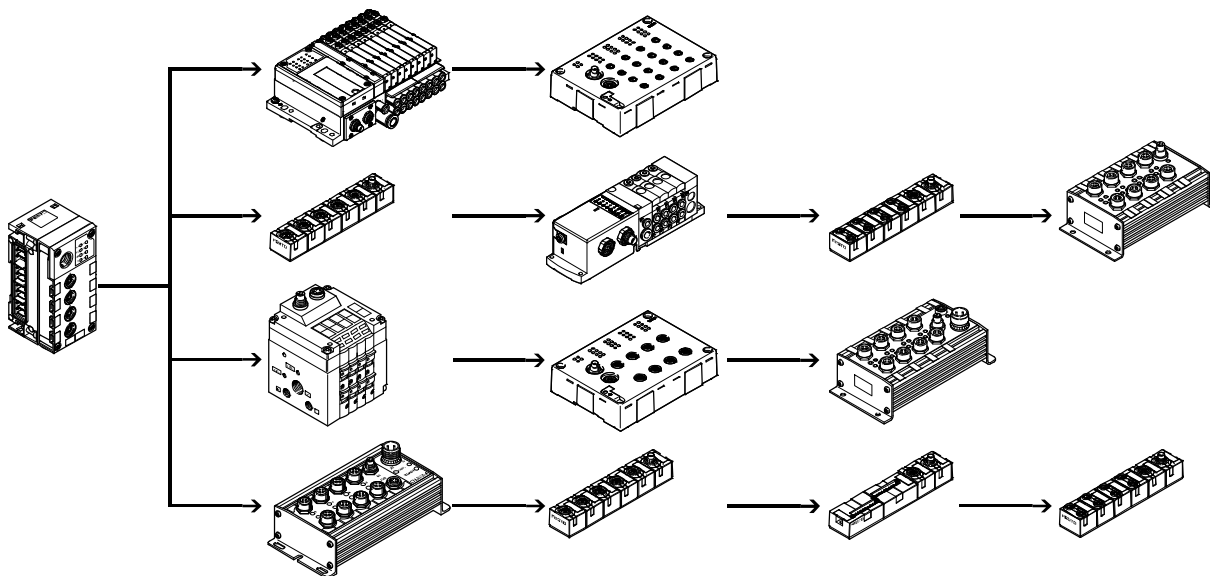

CPI installation system

Key features

FESTO

Node types

Fieldbus

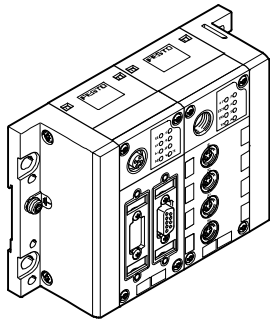

CPX with CP interface
CPX-...

Valve terminal

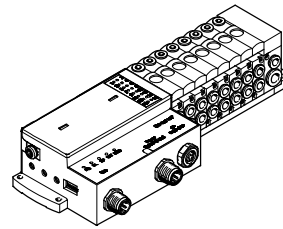

with CP string extension
CPV, CPV-SC, MPA-S

Configurator

Selecting a CPI system using the online catalogue is quick and easy thanks to the convenient configurator provided. This makes it much easier to find the right product.

Components from the CPI system series, type CTEC, are ordered using the order code.

Ordering system for type 55E

→ Internet:ctec

Online via: → www.festo.com

CPI installation system

Peripherals overview

FESTO

Integration of the CPI installation system in various connection concepts

Centralised pneumatic connection (valve terminal)

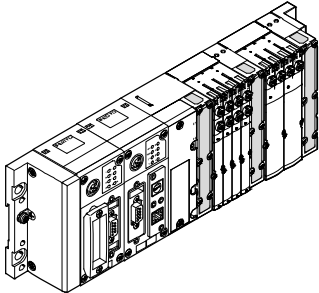

Advantages

- Pneumatic multiple connector plate
- Less tubing required than with individual valves
- Common valve air supply
- Central positioning
- Material, weight and cost savings

Disadvantages

- Only effective with a large number of closely spaced actuators
- Heavier than an individual valve (lower overall weight than the same number of individual valves), which may make assembly on moving systems or in very cramped installation spaces difficult
- Longer tube lengths are occasionally required, ruling out the possibility of optimum pneumatic performance

Decentralised pneumatic connection (individual valve/valve on individual sub-base)

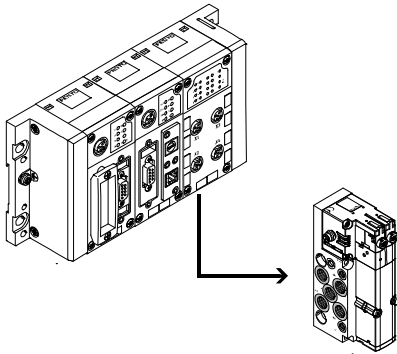

Advantages

- Can be positioned directly at the actuator, can even be integrated
- Short tubing length to the actuator enables short switching times
- Optimum pneumatic timing and performance possible

Disadvantages

- Air supply per valve requires more tubing
- Serial electrical interlinking not advisable/possible
- More complex electrical installation

Centralised electrical connection (multi-pin plug/bus connection/standalone minicontroller)

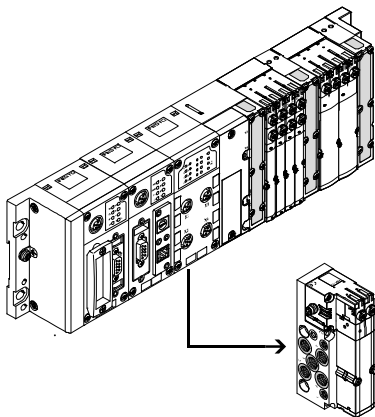

Advantages

- Internal electrical interlinking requires less cabling
- Increased transparency
- Material, weight and cost savings
- Ideal for connecting a large number of closely spaced valves

Disadvantages

- Not suitable for individual, more widely separated applications due to the more complex cabling
- More complex individual components (cables, fieldbus modules)

CPI installation system

Peripherals overview

Integration of the CPI installation system in various connection concepts

Decentralised electrical connection (CPI system/individual valve/valve on individual sub-base/valve manifold)

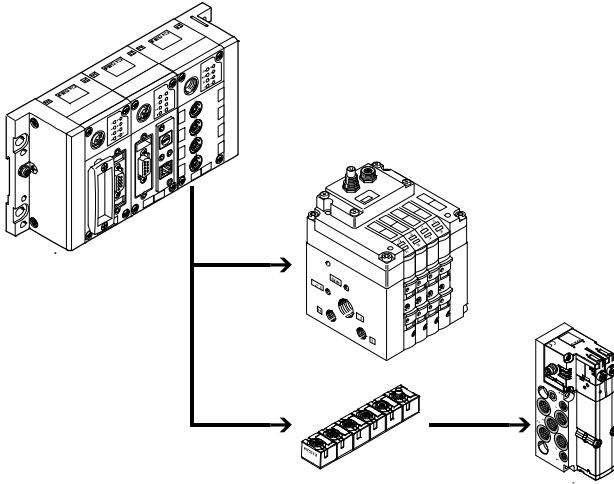

Advantages

- CPI system with reduced installation complexity for groups of actuators/sensors
- Different levels of complexity with widely separated individual components
- Easy replacement of components during servicing
- Optimum pneumatic timing and performance possible

Disadvantages

- Limited spatial expansion possible (CPI system up to 10 m, AS-interface up to 100 m)
- High installation costs

Combined centralised and decentralised connection (valve terminal with CP interface/output module)

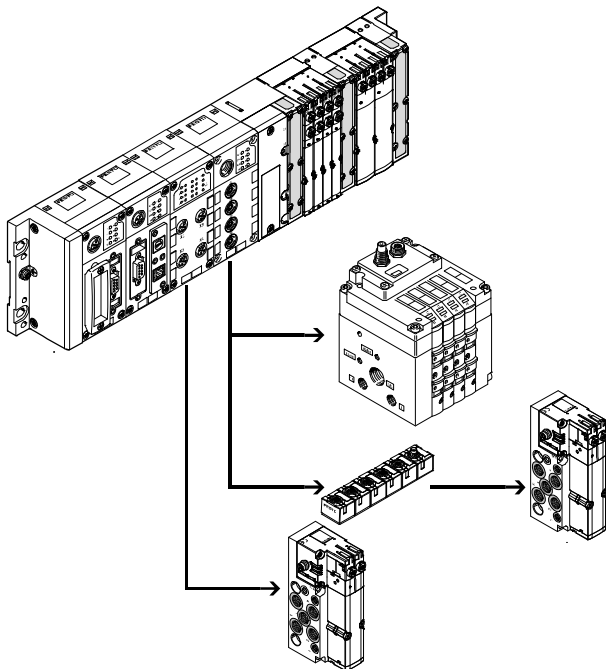

Advantages

- Can be scaled to different requirements within a system
- One control interface in the system, reduces installation complexity with closely and widely spaced actuators
- Enables an optimum electrical and pneumatic control chain

Disadvantages

- Application must at least partially meet the requirements of a centralised connection

Connection of the CPI installation system to a higher-level controller

Bus node/Industrial Ethernet

Different bus nodes are used for integration in the control systems of various manufacturers.

The CPI system can therefore be operated via more than 90% of the most commonly used bus systems.

- PROFIBUS
- INTERBUS
- DeviceNet
- CANopen
- CC-Link
- EtherNet/IP
- PROFINET
- POWERLINK
- EtherCAT
- Sercos III

Control block

The optional Front End Controller CPX-FEC enables simultaneous access via Ethernet and an integrated web server, as well as autonomous pre-processing.

- Ethernet
- TCP/IP
- Web

CPI installation system

Peripherals overview

Connection of the CPI installation system to a higher-level controller

Overview

CPX bus node/control block

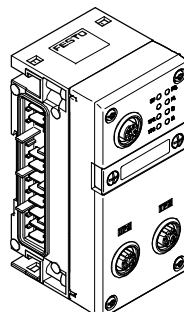
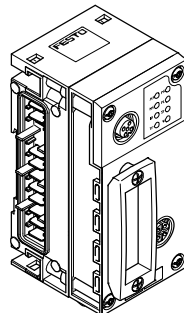
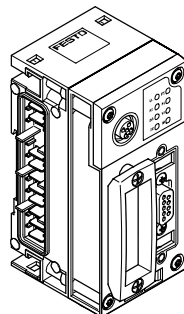
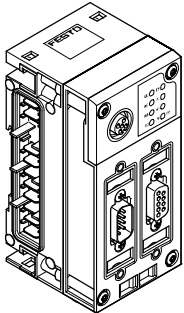

CPX CP-Interface

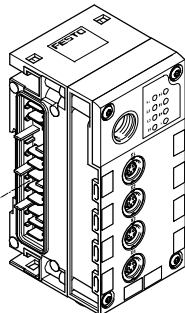

Bus protocol/bus node

INTERBUS

FB6
FB20
FB21

Special features

- Up to 96 digital inputs/outputs
- 6 analogue inputs/outputs

DeviceNet

FB11

- Up to 512 digital inputs/outputs
- 18 analogue inputs/outputs

PROFIBUS DP

FB13

- Up to 512 digital inputs/outputs
- 18 analogue inputs/outputs

CANopen

FB14

- Up to 64 digital inputs and 64 digital outputs
- 8 analogue inputs and 8 analogue outputs

CC-Link

FB23-24

- Up to 512 digital inputs/outputs
- 32 analogue inputs/outputs

EtherNet/IP

FB32
FB36

- Up to 128 digital inputs/outputs
- 8 analogue inputs/outputs

PROFINET

FB33
FB34
FB35
FB41

- Up to 512 digital inputs/outputs
- 32 analogue inputs/outputs

EtherCAT

FB37
FB38

- Up to 512 digital inputs/outputs
- 32 analogue inputs/outputs

POWERLINK

FB40

- Up to 512 digital inputs/outputs
- 32 analogue inputs/outputs

Sercos III

FB39

- Up to 512 digital inputs/outputs
- 32 analogue inputs/outputs

Technical data CPX

→ Internet: cpx

CPI installation system

Peripherals overview

Connection of modules in the CPI installation system

CP interface within the context of the CPX terminal

Using the CP interface as a module of the CPX terminal facilitates the progression from the CP system to the CPI system.

All CP modules are both downwards and upwards compatible and can therefore be used in the CP system and in the CPI system.

This extension has doubled the scalability and range of CP modules that can be used:

- 4 CP strings
- Up to 4 modules per string
- Up to 32 inputs and outputs per CP string

An added advantage of the CPI system is its extremely user-friendly access possibilities via the CPX bus node and the CPX-FEC:

- Data pre-processing
- Diagnostics via software
- Reading out of status information
- Display via permanently installed or mobile unit
- Remote maintenance with CPX-FEC and Ethernet connection

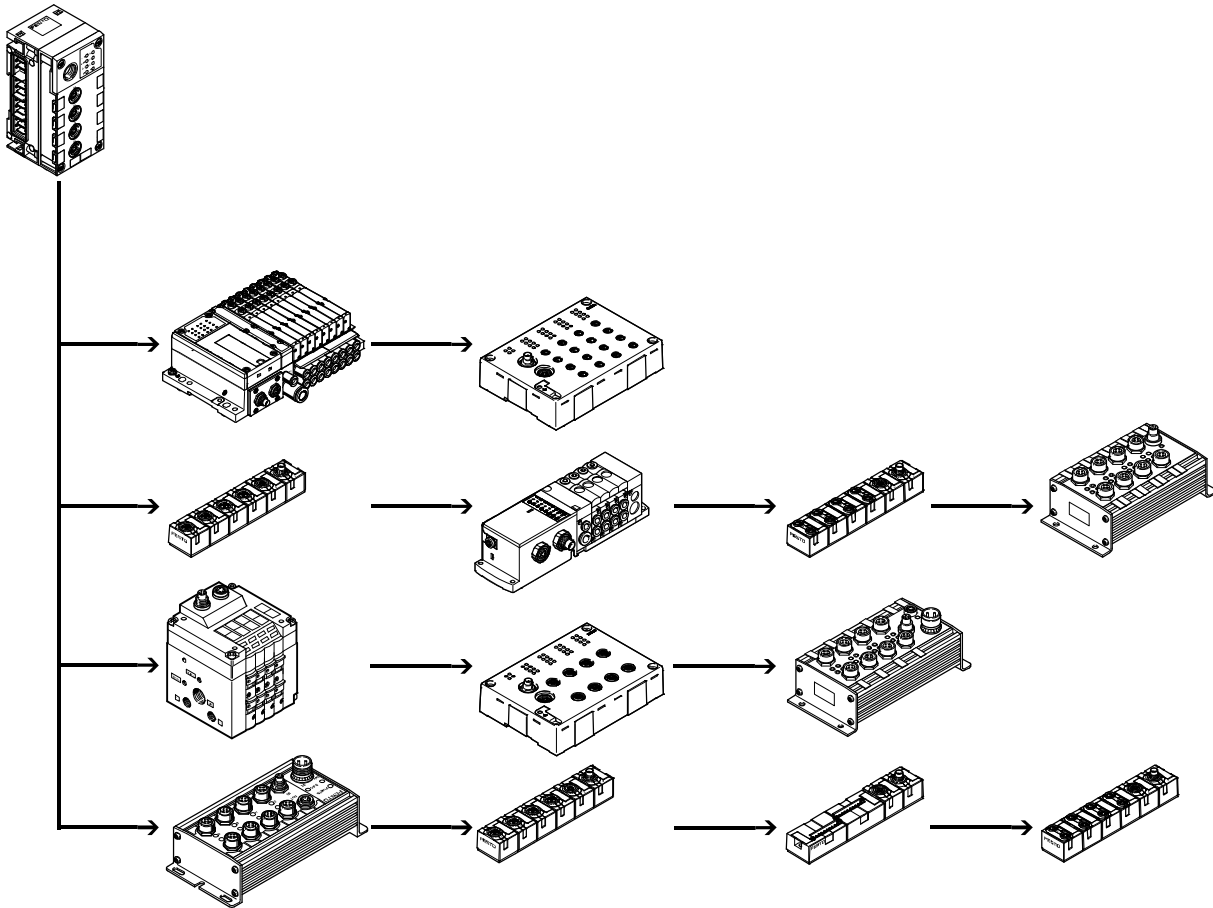

CPI installation system

Connection options

Fieldbus Direct			
Special feature	Application	Characteristics of Fieldbus Direct	
<p>The Fieldbus Direct product range is the most compact way of connecting valves to a fieldbus. The bus node is directly integrated in the electrical actuation of the valve terminal and therefore takes up only a minimal amount of space.</p>	<p>Fieldbus Direct is a system for the compact connection of a valve terminal to different bus standards. The most important bus protocols including PROFIBUS, INTERBUS, DeviceNet and CANopen are supported. The CP string extension option allows the functions and components of the CPI installation system to be used.</p>	<ul style="list-style-type: none"> Extremely compact and space-saving design Low-cost solution for the connection of a small number of valves to the fieldbus Direct front-end integration with a high degree of protection (IP65) Comprehensive diagnostics and condition monitoring 	<p> Note</p> <p>The range of functions and combination options of CPV, CPV-SC and MPA-S valves are described in detail in</p> <ul style="list-style-type: none"> → Internet: cpv (Valve terminal CPV) → Internet: cpv-sc (Valve terminal CPV-SC) → Internet: mpa-s (Valve terminal MPA-S)

Fieldbus Direct and CP string extension			
<p>The optional string extension allows a further valve terminal and I/O modules to be connected to the Fieldbus Direct bus node.</p> <ul style="list-style-type: none"> A CP string of the CP system is integrated in the bus node as an extension Different input and output modules as well as CPV and MPA-S valve terminals can be connected 	<p>The maximum length of the CP string extension is 10 metres, which means that the extension modules can be mounted directly on-site. All of the required electrical signals including load current supply are transmitted via the CP cable, which in turn means that no further installation is needed on the expansion module.</p>	<p>The CP string interface offers:</p> <ul style="list-style-type: none"> Max. 32 input signals Max. 32 output signals for output modules 24 V DC or solenoid coils Logic and sensor supply for the input modules 	<ul style="list-style-type: none"> Load voltage supply for the valve terminals Logic supply for the output modules

CPI installation system

Connection options

Fieldbus Direct with CP string extension

CPV valve terminal

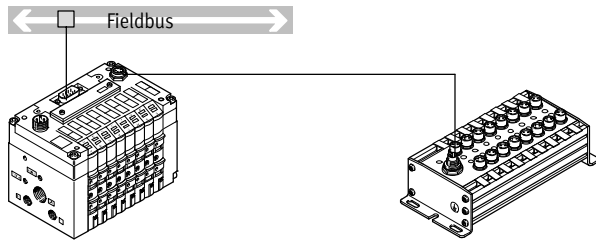

- 4 to 8 valve positions
- DeviceNet
- CANopen
- PROFIBUS DP
- ABB CS31
- INTERBUS
- Moeller Suconet
- Festo fieldbus
- Beckhoff
- CC-Link
- 4 to 16 solenoid coils

Further information
➔ Internet: cpv

CPV-SC

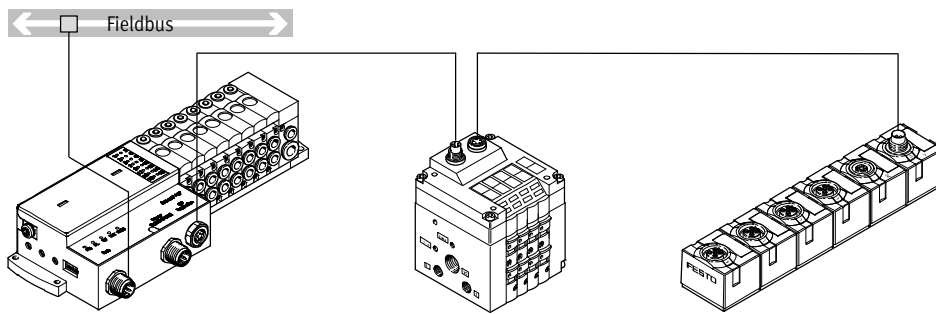

- 4 to 16 valve positions
- DeviceNet connection
- PROFIBUS DP
- 4 to 16 solenoid coils

Further information
➔ Internet: cpv-sc

Compact vision system SB0C-Q/SB0I-Q with CP interface

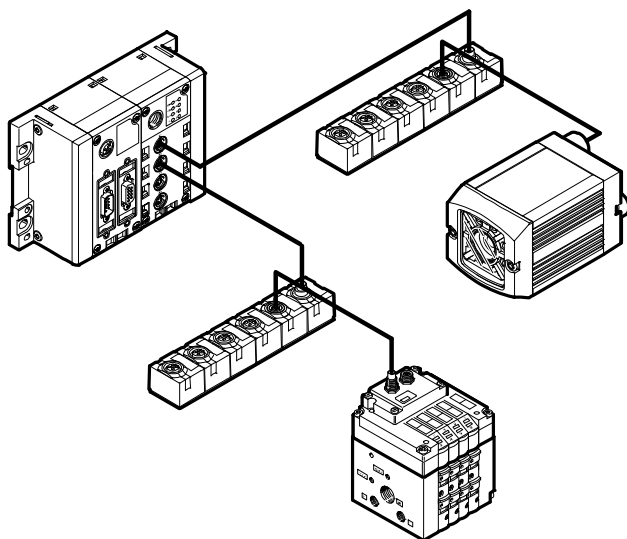

The compact vision system SB0x-Q can be integrated into a Festo CPI network. In this case it functions like a binary module with 16 inputs and outputs.

- Address requirement: 16 digital inputs/outputs
- CPI connection

Further information
➔ Internet: sboc-q, sboi-q

CPI installation system

Connection options

FESTO

Connection of input and output modules in the CPI installation system

CP connecting cable

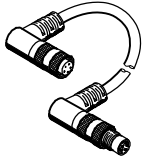

KVI-CP-3-...



Note

The total length of all CP cables in a CP string must not exceed 10 m.

- Pre-assembled cables for connecting the CP modules
- Lengths from 0.25 to 8 metres
- M9 plug/socket, 5-pin
- Straight/angled version in any combination

Further information

➔ Internet: kvi-cp

CP input/output modules in sturdy, universal and compact design or as a valve terminal

The connection technology for the sensors and additional actuators offers a wide range of digital and analogue input and output modules and is freely selectable – depending on your standard or application:

- M12-5PIN
- M8-3PIN
- M8-4PIN
- Spring-loaded terminal or screw terminal technology

The maximum number of inputs/outputs that can be connected to the individual modules can vary depending on the application. The following module sizes are available:

- Input modules with 8, 16 or 32 channels
- Output modules with 4 or 8 channels
- CPV with 4, 6 or 8 valve slices (max. 16 valves)
- MPA-S with 2 ... 32 valves
- CPV-SC with 4 ... 16 valves

Valve terminals with CP interface

CPV valve terminal

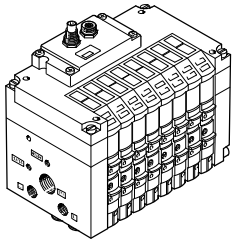

CPV10
CPV14
CPV18

- Max. 16 valves in 8 valve slices
- Highly compact and space-saving
- Width 10, 14, 18 mm
- Nominal flow rate 400/800/1600 l/min
- CPV10 and CPV14 with CPI functionality
- CPV18 with CP functionality

Further information

➔ Internet: cpv
(Valve terminal CPV)

MPA-S valve terminal

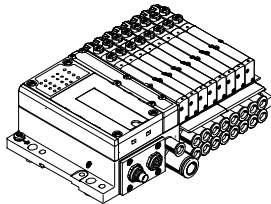

MPA1
MPA2

- Max. 32 valves (32 solenoid coils, 16 valve positions)
- Modular and versatile
- Width 10, 20 mm
- Nominal flow rate 360/700 l/min
- CPI functionality

Further information

➔ Internet: mpa-s
(Valve terminal MPA-S)

CPV-SC valve terminal

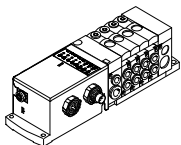

CPV-SC

- Max. 16 valves
- Extremely compact
- Width 10 mm
- Nominal flow rate 170 l/min
- CPI functionality

Further information

➔ Internet: cpv-sc
(Valve terminal CPV-SC)

CPI installation system

Key features – Input/output modules

Connection of input and output modules in the CPI installation system

Special features of the CP input/output modules of sturdy design

The sturdy CP input/output modules have a highly resistant aluminium housing and its internal electronic components can be repaired or replaced.

As a CP-E...Z or output modules they have a separate load voltage supply, which means less load on the CP interface and CP cable and more power for

the connected consuming devices. This also facilitates separate disconnection of the consuming devices.

High degree of protection (IP65), surpassed only by the compact CP modules with IP65/67 protection. The only exception is the IP20 protection offered by the module with clamped terminal connection for installation in control cabinets.

CP input modules of sturdy design

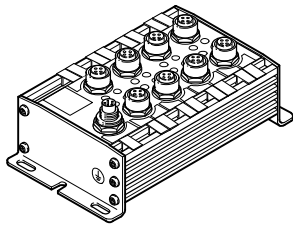

CP-E16-M12x2-5POL
CP-E16N-M12x2

- 16 inputs 24 V DC
- Signal status display via 16 LEDs
- Operating status display
- CP functionality

- M12 plug, double allocation
- 1x M9 CP connection
- PNP/NPN, IP65

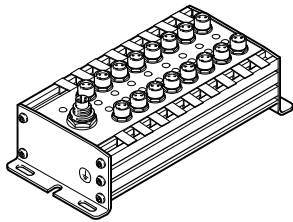

CP-E16-M8
CP-E16N-M8

- 16 inputs 24 V DC
- Signal status display via 16 LEDs
- Operating status display
- CP functionality

- M8 plug, single allocation
- 1x M9 CP connection
- PNP/NPN, IP65

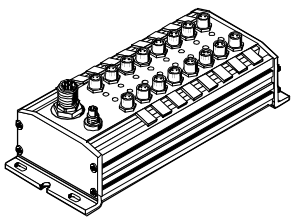

CP-E16-M8-Z

- 16 inputs 24 V DC
- Signal status display via 16 LEDs
- Operating status display
- CP functionality

- Galvanic isolation through additional power supply
- M8 plug, single allocation
- 1x M9 CP connection
- Separate sensor supply
- PNP/NPN, IP65

CP output modules of sturdy design

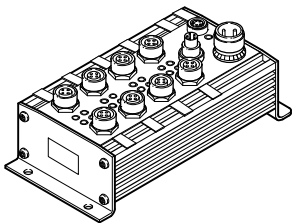

CP-A08-M12-5POL
CP-A08N-M12

- 8 outputs 24 V DC
- Output signal display via 8 LEDs
- Operating status display
- M12 plug, single allocation
- CP functionality

- 2x M9 CP connection
- Separate load voltage
- Outputs resistant to overloads and short circuits
- PNP/NPN, IP65

CPI installation system

Key features – Input/output modules

Connection of input and output modules in the CPI installation system

Special features of the CP input/output modules of economical design

In addition to the sturdy CP input/output modules and the compact CP input/output modules, there are also the economical modules with the design features of the compact modules, but with a greater number of inputs/outputs.

The economical CP modules feature a compact design, coupled with a large number of inputs/outputs.

The modules can be used in connection with the following valve terminals:

- CPV, MPA-S, CPV-SC

Application:

- Same function, configuration and commissioning as sturdy or compact CP modules
- Integrated H-rail mounting and earthing plate
- Centrally placed status and diagnostic LEDs
- The economical CP modules and the other CP modules can be operated together on a string

- The maximum number of modules per CP string is as follows:
 - CPI system: max. 4 modules or max. 32 inputs and 32 outputs
 - CP system: one valve terminal/output module and one input module

CP input modules of economical design

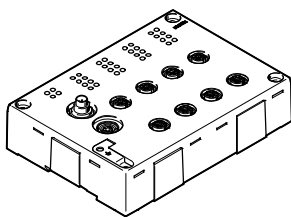

CP-E16-M12-EL

- 16 inputs 24 V DC
- Signal status display via 16 LEDs
- Operating status display (per module and per group of four inputs)
- CPI functionality

- 8x M12 plug, 5-pin, double allocation
- 2x M9 CP connection
- PNP, IP65

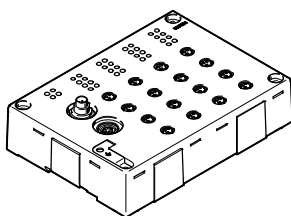

CP-E16-M8-EL

- 16 inputs 24 V DC
- Signal status display via 16 LEDs
- Operating status display (per module and per group of four inputs)
- CPI functionality

- 16x M8 plug, 3-pin, single allocation
- 2x M9 CP connection
- PNP, IP65

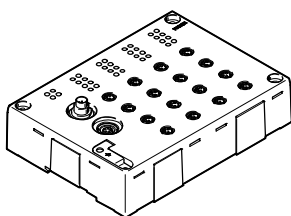

CP-E32-M8-EL

- 32 inputs 24 V DC
- Signal status display via 32 LEDs
- Operating status display (per module)
- CPI functionality

- 16x M8 plug, 4-pin, double allocation
- 2x M9 CP connection
- PNP, IP65

CP output modules of economical design

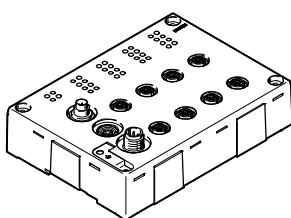

CP-A08-M12-EL-Z

- 8 outputs 24 V DC
- Signal status display via 4 LEDs
- Operating status display (per module and per channel/output)
- CPI functionality

- 8x M12 plug, 5-pin, double allocation
- 2x M9 CP connection
- Outputs resistant to overloads and short circuits
- PNP, IP65

CPI installation system

Key features – Input/output modules

Connection of input and output modules in the CPI installation system

Special features of the CP input/output modules of compact design

In addition to the sturdy and economical CP input/output modules, there is also the compact series of CP input/output modules. These have an optimised, compact design, are made from plastic and are very light. They are, of course, available with the high degree of protection IP65/67 (exception: terminal modules in IP20 for installation in a protected fitting space).

The compact CP modules are designed for use in handling and assembly wherever space requirements and product weight play a role.

The modules can be used in connection with the following valve terminals:

- CPV, MPA-S, CPV-SC

Application:

- The modules can be positioned closer to the actuators thanks to the smaller dimensions
- Same function, configuration and commissioning as sturdy or economical CP modules
- The compact CP modules and the other CP modules can be operated together on a string

- The maximum number of modules per CP string is as follows:
 - CPI system: max. 4 modules or max. 32 inputs and 32 outputs
 - CP system: one valve terminal/output module and one input module

CP input modules of compact design

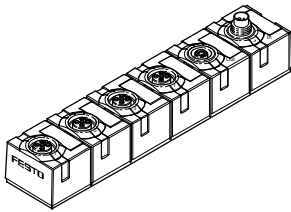

CP-E08-M12x2-CL

- 8 inputs 24 V DC
- Signal status display via 8 LEDs
- Operating status display
- CPI functionality

- 4x M12 plug, 5-pin, double allocation
- 2x M9 CP connection
- PNP, IP65/67

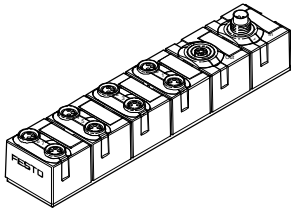

CP-E08-M8-CL

- 8 inputs 24 V DC
- Signal status display via 8 LEDs
- Operating status display
- CPI functionality

- 8x M8 plug, 3-pin, single allocation
- 2x M9 CP connection
- PNP, IP65/67

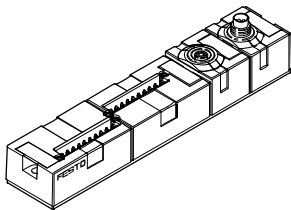

CP-E16-KL-CL

- 16 inputs 24 V DC
- Indirect signal status display via LEDs in the connection set of the tension-spring socket
- Operating status display
- CPI functionality

- Screw terminal or tension-spring sockets
- 2x M9 CP connection
- PNP, IP20

CP output modules of compact design

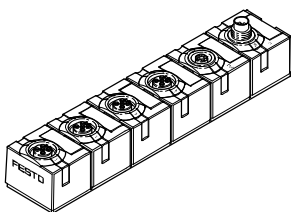

CP-A04-M12x2-CL

- 4 outputs 24 V DC
- Signal status display via 4 LEDs
- Operating status display
- CPI functionality

- 4x M12 plug, 5-pin, double allocation
- 2x M9 CP connection
- Outputs resistant to overloads and short circuits
- PNP, IP65/67

CPI installation system

Key features – Mounting options

H-rail mounting

CP interface

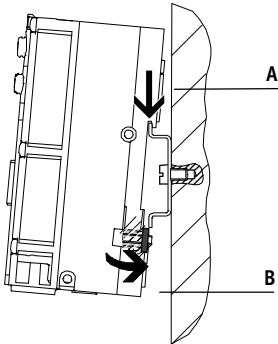

The H-rail mounting is formed in the reverse profile of the CPX interlocking blocks. The CPX terminal can be attached to the H-rail using the H-rail mounting.

The CPX terminal is attached to the H-rail as follows (see arrow A). It is first swivelled on the H-rail and then secured in place with the clamping component (see arrow B).

The following mounting kit is required for H-rail mounting (plus mounting kit for optionally mounted valves):

- CPX-CPA-BG-NRH

This enables mounting on H-rails to EN 60715.

Economical CP modules

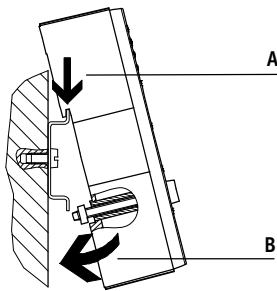

The H-rail mounting is impressed in the reverse profile of the economical CP modules. The modules can be attached to the H-rail using the H-rail mounting.

The module is attached to the H-rail as follows (see arrow A). It is first swivelled on the H-rail and then secured in place with the clamping component (see arrow B).

The scope of delivery includes the following mounting kit for H-rail mounting:

- CP-EL-HS

This enables mounting on H-rails to EN 60715.

Compact and sturdy CP modules

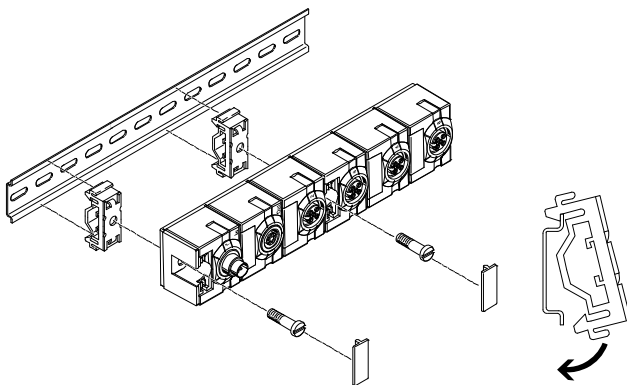

For the CP modules there is a mounting kit that can be used on an H-rail. On the compact CP modules, the mounting holes are covered by inscription labels.

The following mounting kit is required for H-rail mounting:

- CP-TS-HS35

This enables mounting on H-rails to EN 60715.

CPI installation system

Key features – Mounting options

FESTO

Wall mounting

CP modules

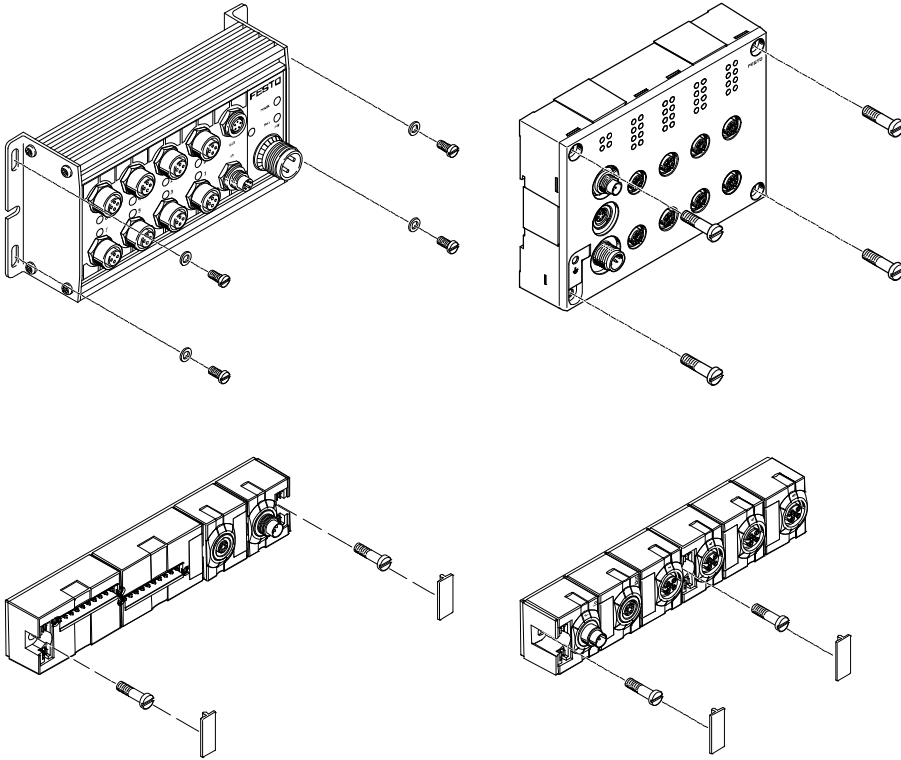

The CP modules (with screws up to 4 mm in diameter) can be mounted on even surfaces in almost any position using the mounting holes.

-  - Note

The mounting holes on the compact CP modules are covered by inscription labels.

CPI installation system

Key features – Inscription system

Inscription system

All CP modules have holders for inscription labels.

Inscription labels/holders are not included in the scope of delivery and can be ordered separately.

The labels can be pre-assembled on request.

Robust CP modules

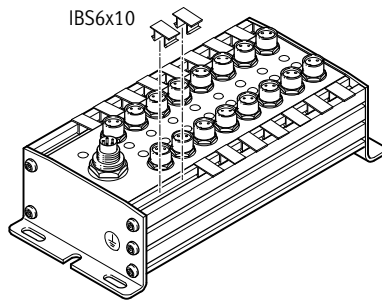

The sturdy CP modules have two slots in which the inscription labels IBS6x10 (Part No. 18576) can be fitted. At least one inscription label can be fitted per connection.

The IBS6x10 are plastic clips that can be printed on, written on or affixed with labels.

Economical CP modules

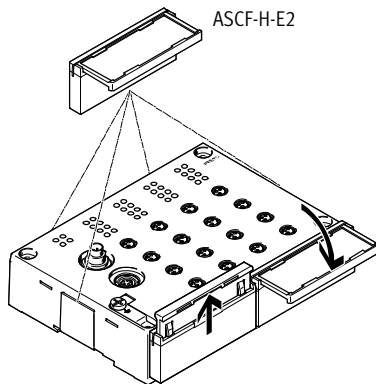

The economical CP modules have six lateral fixtures for one inscription label holder ASCF-H-E2 each (Part No. 547473).

The ASCF-H-E2 are transparent hinged label holders for holding pre-assembled paper inscription labels. The label can be read when the label holder is opened out.

Compact CP modules

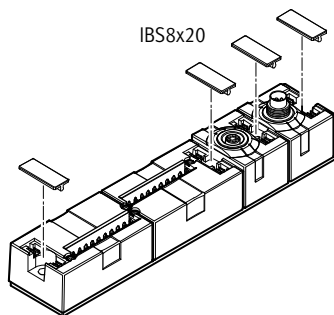

The compact CP modules have a holder for an inscription label IBS8x20 (Part No. 539388) for each connection.

The IBS8x20 are plastic clips that can be printed on, written on or affixed with labels.

CPI installation system

Key features – Power supply

Operating voltage and load current supply

The following functions are made available to the connected modules through the CP cable:

- Connection for data exchange
- Operating voltage for internal electronics
- Load current supply for the connected inputs/sensors and/or outputs/actuators

CP-E...Z or output modules from the sturdy and the economical series have a separate load voltage supply:

- Less load on the CP interface and CP cable
- 0.5 A per output (max. 4 A supply per output module)
- 1 A per 8 inputs
- Separate disconnection of the consuming devices possible

Every module in the CPI system is protected separately against overload with electronic fuses.

The input modules without additional supply provide a maximum sensor supply of 500 mA in the sturdy design, 800 mA in the compact design and

700 mA in the economical design with 16 inputs and 1400 mA with 32 inputs.

The input modules with additional supply provide up to 2 A residual current for the connected sensors.

Example of circuits for additional power supply

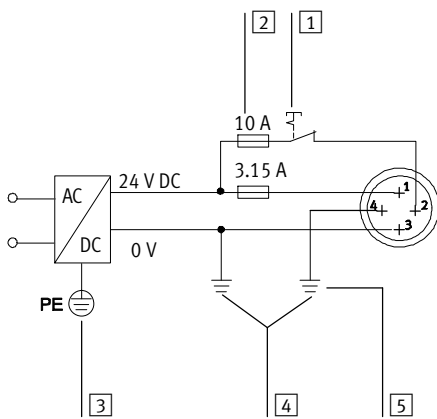

- 1 Load voltage supply (can be disconnected separately)
- 2 External fuses
- 3 Protective earth
- 4 Equipotential bonding
- 5 Earth terminal on pin 4, rated for 12 A

Pin allocation of plug for additional power supply

Pin allocation	Pin	Signal	Designation
	1	24 V DC	Supply for electronics and inputs
	2	24 V DC	Load supply for valves/outputs
	3	0 V	Equipotential bonding
	4	0 V	Earth terminal and equipotential bonding, rated for 12 A

CPI installation system

Key features – Power supply

Power supply concept of the CPX terminal

Circuit diagram for M18 power supply/system supply (example)

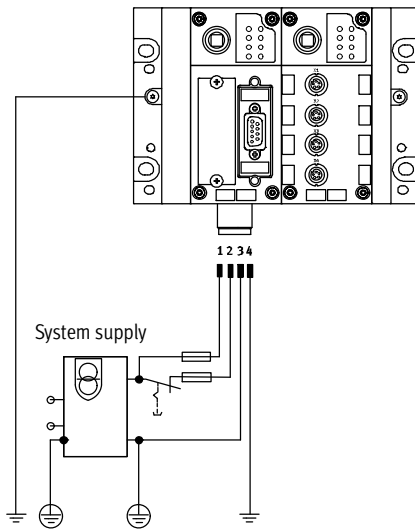

The use of decentralised devices on the fieldbus – particularly with high protection for direct machine mounting – demands a flexible power supply concept.

The CPX terminal facilitates the connection of all voltages via one connection.

A distinction is made between supply for

- electronics and sensors/inputs
- valves
- actuators/outputs

Selectable connecting thread:

- M18
- 7/8"
- AIDA push-pull

 Note

The CP interface connects the 0 V of the power supply for the electronics/inputs and the valves. To prevent overloads, the power must therefore

be supplied using just one power supply module or using power supply units with a common earthed conductor.

Interlinking blocks

Many applications require segmenting of the voltage into zones. This is true in particular of the separate disconnection of connected actuators (solenoid coils/outputs).

The separation of voltages for valves and the realisation of different voltage segments for electrical outputs and sensors are supported by the different

interlinking blocks of the CPX terminal:

- With system supply
- Without power supply
- With additional power supply for electrical outputs
- With additional power supply for valves

The supply voltages are supplied using a

- 4-pin M18 plug
- 4-pin 7/8" plug
- 5-pin 7/8" plug
- AIDA push-pull, 5-pin

 Note

The max. current is limited to 12 A with the 7/8" system supply. When using a conventional pre-assembled cable, the max. current is limited to 8 A.

CPI installation system

Key features – Diagnostics

General limits			
System supply	CP interface		
<p>The system supply provides the internal voltage for the entire CPX system with</p> <ul style="list-style-type: none"> • max. 16 A for electronics and sensors/inputs • max. 16 A for actuators/outputs and valves 	<p>The CP interface and the CP modules connected to the CP interface get their operating voltage from the connection for electronics and sensors/inputs.</p>	<p>The operating voltage for the sensors/actuators connected to the CP modules is supplied from the voltage for valves. The CP interface supplies the</p>	<p>connected CP modules with</p> <p>The CP interface supplies the connected CP modules with</p> <ul style="list-style-type: none"> • max. 1.6 A per CP string

Diagnostics			
General information	Diagnostics via LED	Diagnostics via control program/CPX-MMI	
<p>A comprehensive diagnostic function is available for each string.</p> <p>The diagnostic information can either be detected via the LEDs on the module and then read out and evaluated via the controller software (non-field-bus-specific) or displayed directly on the CPX terminal via the CPX-MMI and then evaluated and edited.</p>	<ul style="list-style-type: none"> • Error in bus communication • POWER, power supply display for internal electronics • POWER V, load voltage display for valves • 0 ... 3, CP string allocation changed or interrupted <p>There are also bus-specific LED displays.</p>	<ul style="list-style-type: none"> • Configuration error • Bus error • Operating voltage failure • Falling below voltage tolerance (valves) • Short circuit in sensor voltage supply 	<ul style="list-style-type: none"> • Operating voltage failure at the output modules • Short circuit/overload at the output modules • Connection to one or more CP modules interrupted (valve terminal, input/output modules)

Diagnostics via CPX terminal

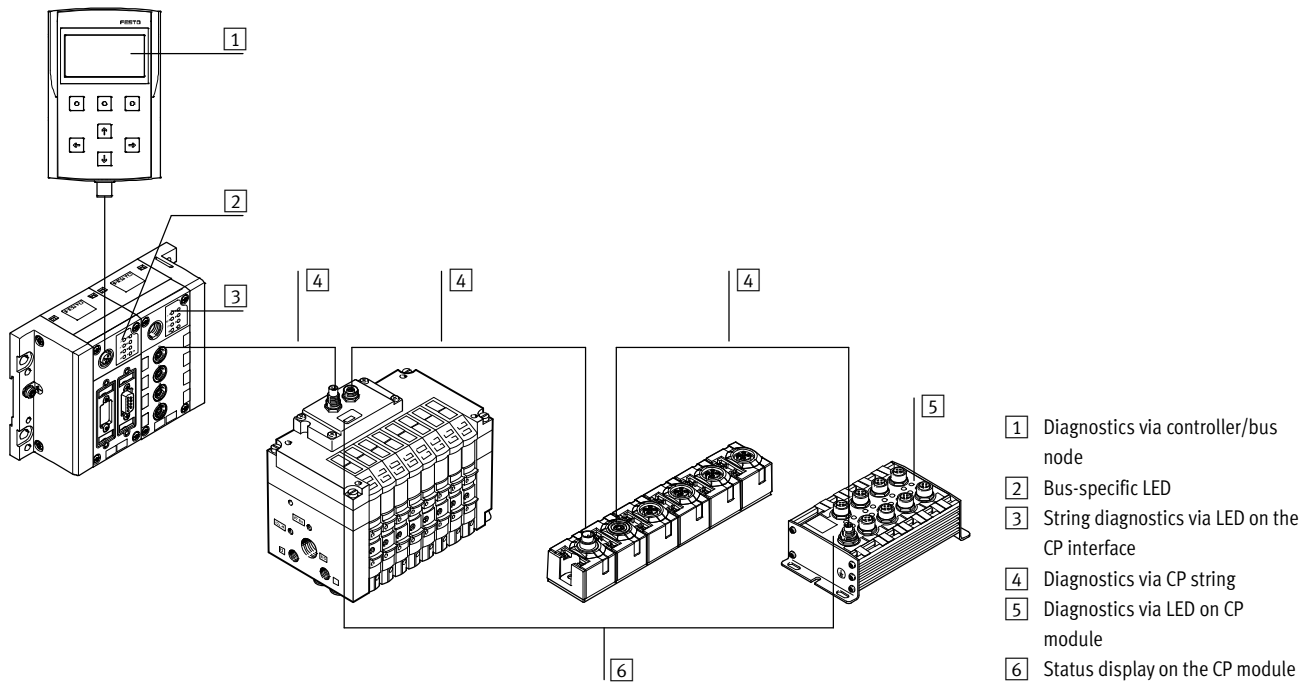

CPI installation system

Key features – CP interface

Diagnostics

Diagnostics via CP bus node

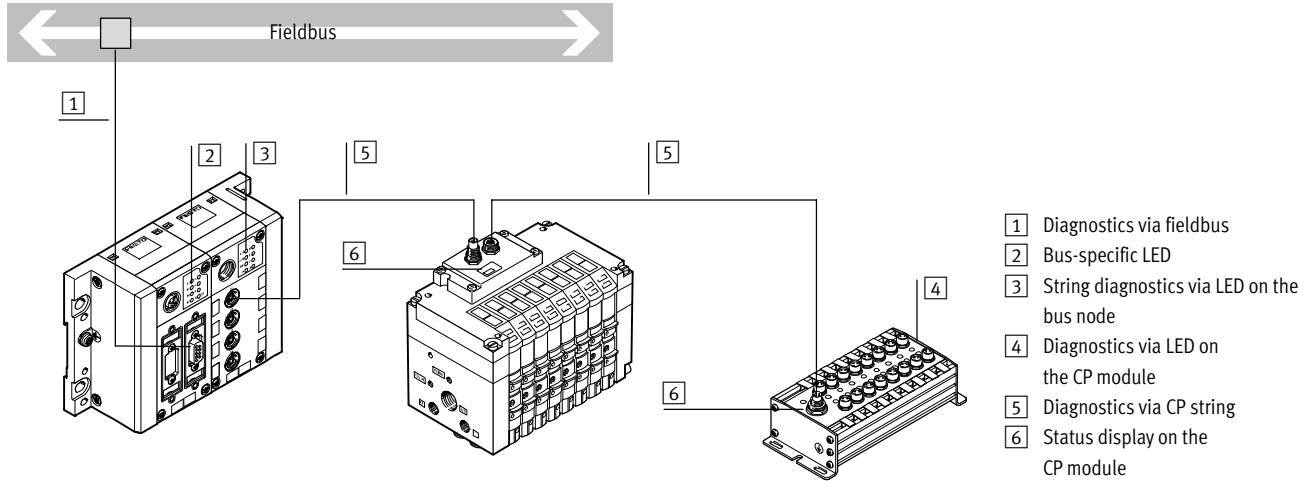

- 1 Diagnostics via fieldbus
- 2 Bus-specific LED
- 3 String diagnostics via LED on the bus node
- 4 Diagnostics via LED on the CP module
- 5 Diagnostics via CP string
- 6 Status display on the CP module

Diagnostic LEDs on the CP modules

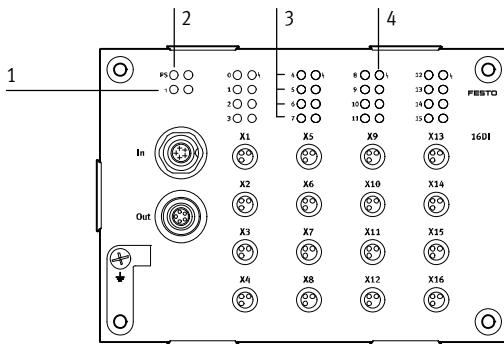

- 1 Status LED for CP communication (PS, green)
- 2 Status LED (module) for short circuit/overload of sensor supply (red)
- 3 Status LEDs for inputs (status display, green)
- 4 Status LED (group, only with CP-E16-...-EL) for short circuit/overload of sensor supply (red)

In addition to the status display per module and per individual channel/input, the economical modules with 16 inputs additionally have a status display for a group of four inputs. The following inputs are combined into groups of four:

- 0 ... 3
- 4 ... 7
- 8 ... 11
- 12 ... 15

Parameterisation

Allocation of the addresses to the individual actuators/outputs or sensors/inputs connected to the CP modules is performed in accordance with the bus node or CPX-FEC used (exception: INTERBUS node). Address allocation is performed in accordance with the following rules:

- One CP interface provides four strings with a total of 128 inputs and 128 output addresses.
- A used string occupies 32 inputs and 32 output addresses.
- The addresses are permanently allocated to the strings and CP modules in ascending order.
- Unused address space remains reserved for future extensions.

The CP interface checks the configuration of the connected modules each time the system is switched on and during operation. If a deviation from the saved configuration is detected, an appropriate message is output via the controller software and displayed via LED.

The configuration detected is stored by pressing the Save button (after the operating voltage is switched on at the CP interface).

The configuration is stored each time the CP interface is switched off and back on.

The option is provided of replacing a connected CP module with a module of identical design during operation. Removal of more than one module from the current configuration will be detected as an error; the address spaces of these modules will no longer be actuated.

CPI installation system

Selection aid

System selection aid					
	Modules per string	Outputs/inputs per string	Modules with CP functionality	Modules with CPI functionality	String length [m]
CP system	2	16/16	0 ... 1 input module 0 ... 1 output module	0 ... 1 input module 0 ... 1 output module	0 ... 10
CPI system	4	32/32	0 ... 1 input module 0 ... 1 output module	0 ... 4 input modules 0 ... 4 output modules	0 ... 10

Module selection aid							
	Functionality		Additional power supply	Address requirement		Max. current consumption [A]	→ Page/Internet
	CP	CPI		Inputs	Outputs		
Input modules							
CP-E16-M8	■	–	–	16	–	0.54	28
CP-E16N-M8	■	–	–	16	–	0.59	28
CP-E16-M12x2-5POL	■	–	–	16	–	0.59	28
CP-E16N-M12x2	■	–	–	16	–	0.59	28
CP-E16-M8-Z	■	–	■	16	–	1.04	28
CP-E32-M8-EL	–	■	–	32	–	1.4	34
CP-E16-M8-EL	■	■	–	16	–	0.7	34
CP-E16-M12-EL	■	■	–	16	–	0.7	34
CP-E08-M12-CL	■	■	–	8	–	0.835	40
CP-E08-M8-CL	■	■	–	8	–	0.835	40
CP-E16-KL-CL	■	■	–	16	–	0.835	40
Output modules							
CP-A08-M12-5POL	■	–	■	–	8	2.09	46
CP-A08N-M12	■	–	■	–	8	2.09	46
CP-A08-M12-EL-Z	■	■	■	–	8	4	50
CP-A04-M12-CL	■	■	–	–	4	1.035	54
Connecting cables							
KVI-CP-3-...	■	■	–	–	–	1.6	kvi-cp
Valve terminals							
CPV10-FB-4	■	■	–	–	16	0.327	cpv
CPV10-FB-6	■	■	–	–	16	0.465	cpv
CPV10-FB-8	■	■	–	–	16	0.604	cpv
CPV14-FB-4	■	■	–	–	16	0.419	cpv
CPV14-FB-6	■	■	–	–	16	0.603	cpv
CPV14-FB-8	■	■	–	–	16	0.788	cpv
CPV18-FB-4	■	–	–	–	16	0.624	cpv
CPV18-FB-6	■	–	–	–	16	0.911	cpv
CPV18-FB-8	■	–	–	–	16	1.197	cpv
MPA-S	–	■	■	–	32	3.25	mpa-s
CPV-SC	–	■	–	–	16	0.875	cpv-sc

CPI installation system

Selection aid

Accessory selection aid

Connection M8, 3-pin

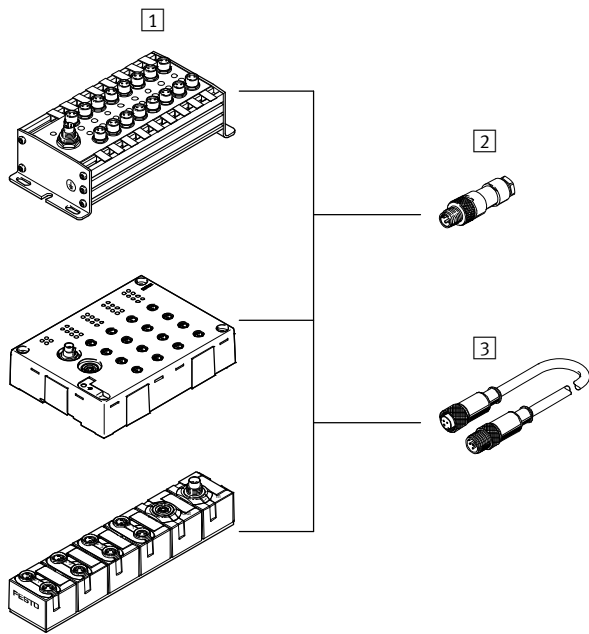

Note

Festo delivers pre-assembled M8/M12 connecting cables (NEBU modular system) on customer request:

- application tailored
- perfectly fitting
- installation saving

1 Input modules	
Type	
CP-E16-M8	
CP-E16N-M8	
CP-E16-M8-Z	
CP-E16-M8-EL	
CP-E08-M8-CL	

Plug connector/connecting cable	
Type	Connection technology
2 Plug connector	
SEA-GS-M8	Solder lug
SEA-3GS-M8-S	Screw terminal
3 Connecting cable	
KM8-M8-GSGD-...	Socket M8, 3-pin
NEBU-...-M8G3	Socket M5, 3-pin
	Socket M8, 3-pin
	Socket M8, 4-pin
	Socket M12, 5-pin
	Open cable end

CPI installation system

Selection aid



Accessory selection aid

Connection for inputs M8, 4-pin

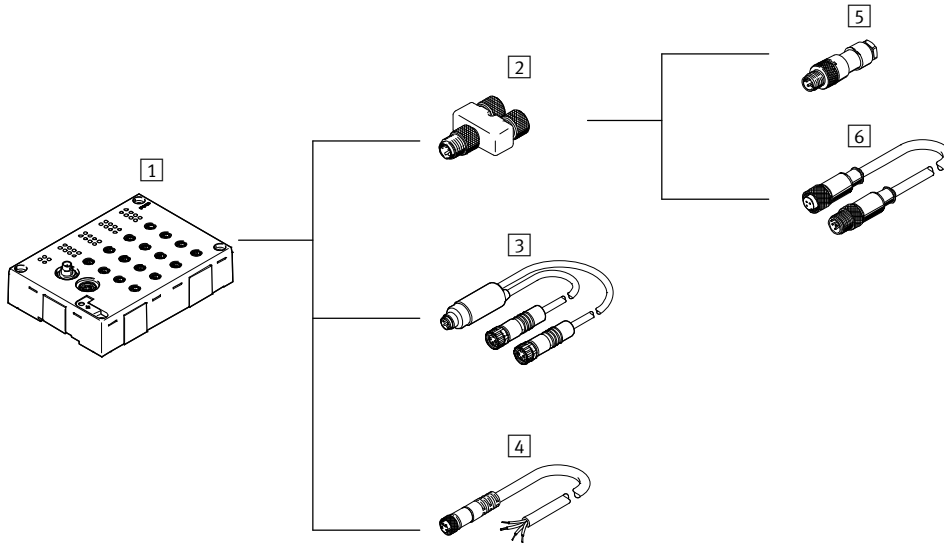

 Note
Festo delivers pre-assembled M8/M12 connecting cables (NEBU modular system) on customer request:

- application tailored
- perfectly fitting
- installation saving

1 Input modules
Type
CP-E32-M8-EL

Plug connector/connecting cable	
Type	Connection technology
2 T-adaptor	
NEDU-M8D3-M8T4	2x socket M8, 3-pin
3 DUO cable	
NEDU-L2R1-M8G3-K-1L1-1L2-M8G4	2x socket M8, 3-pin
4 Connecting cable	
NEBU-...-M8G4	Socket M5, 3-pin
	Socket M8, 3-pin
	Socket M8, 4-pin
	Socket M12, 5-pin
	Open cable end

Plug connector/connecting cable		
Connection technology	Type	Connection technology
5 Plug connector		
Plug M8, 3-pin	SEA-GS-M8	Solder lug
Plug M8, 3-pin	SEA-3GS-M8-S	Screw terminal
6 Connecting cable		
Plug M8, 3-pin	KM8-M8-GSGD-...	Socket M8, 3-pin
Plug M8, 3-pin	NEBU-...-M8G3	Socket M5, 3-pin
		Socket M8, 3-pin
		Socket M8, 4-pin
		Socket M12, 5-pin
		Open cable end

CPI installation system

Selection aid

Accessory selection aid

Connection for inputs M12, 4-pin

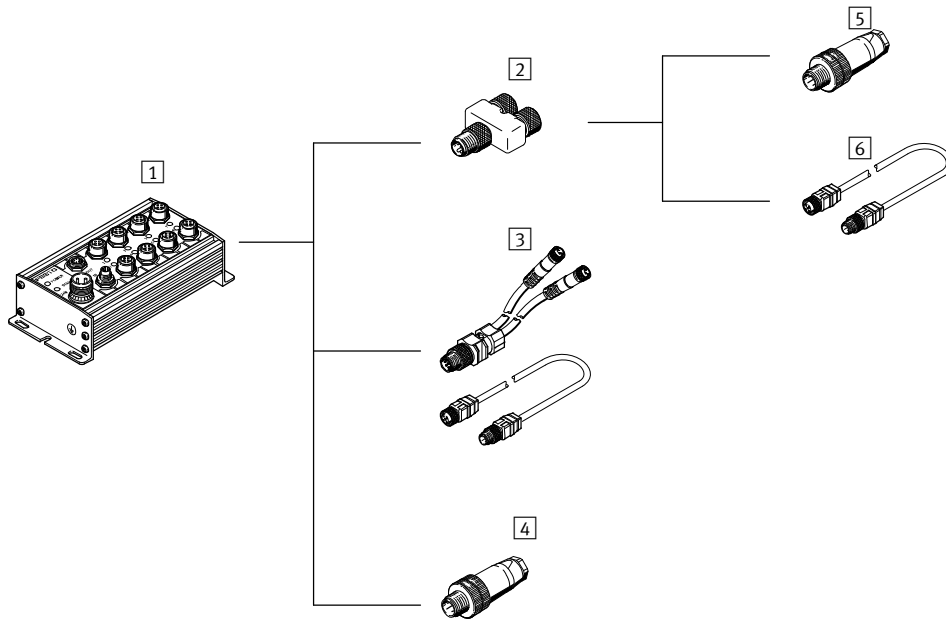

Note

Festo delivers pre-assembled M8/M12 connecting cables (NEBU modular system) on customer request:

- application tailored
- perfectly fitting
- installation saving

1	Input modules
Type	
	CP-E16N-M12x2

Plug connector/connecting cable	
Type	Connection technology
2 T-adaptor	
NEDU-M12D5-M12T4M	2x socket M12, 4-pin
3 Connecting cable	
KM12-DUO-M8-...	2x socket M8, 3-pin
KM12-M12-...	Socket M12, 4-pin
4 Plug connector	
SEA-GS-7	Screw terminal
SEA-4GS-7-2,5	Screw terminal
SEA-GS-11-DUO	Screw terminal

Plug connector/connecting cable		
Connection technology	Type	Connection technology
5 Plug connector		
Plug M12, 4-pin	SEA-GS-7	Screw terminal
Plug M12, 4-pin	SEA-4GS-7-2,5	Screw terminal
6 Connecting cable		
Plug M12, 4-pin	KM12-M12-...	Socket M12, 4-pin

CPI installation system

Selection aid

FESTO

Accessory selection aid

Connection for inputs M12, 5-pin

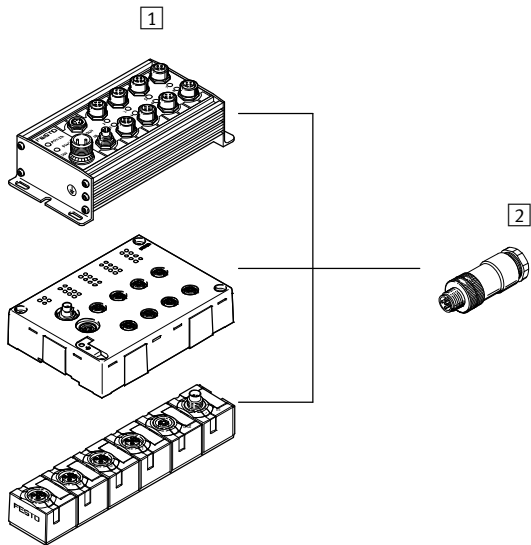

1 Input modules
Type
CP-E16-M12x2-5POL
CP-E16N-M12-EL
CP-E08-M12-CL

2 Plug connector	
Type	Connection technology
SEA-M12-5GS-PG7	Screw terminal
SEA-5GS-11-DUO	Screw terminal

Connection for inputs, tension-spring socket

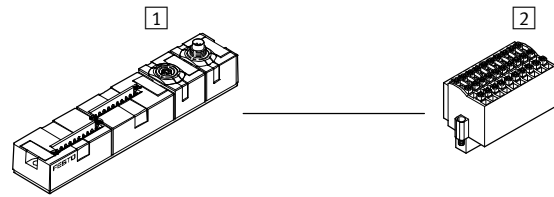

1 Input modules
Type
CP-E16-KL-CL

2 Plug connector	
Type	Connection technology
PS1-SAC31-30POL+L ED	Screw-in tension-spring socket

CPI installation system

Selection aid

Accessory selection aid

Connection for outputs M12, 4-pin

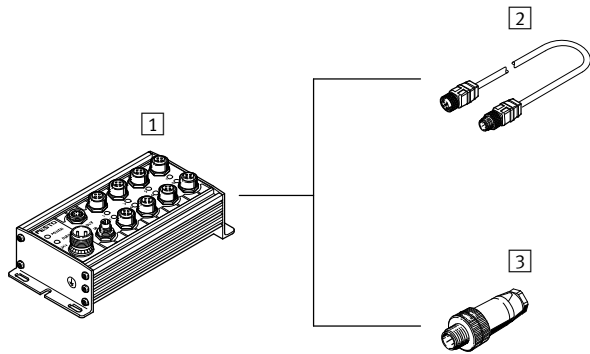

Connection for outputs M12, 5-pin

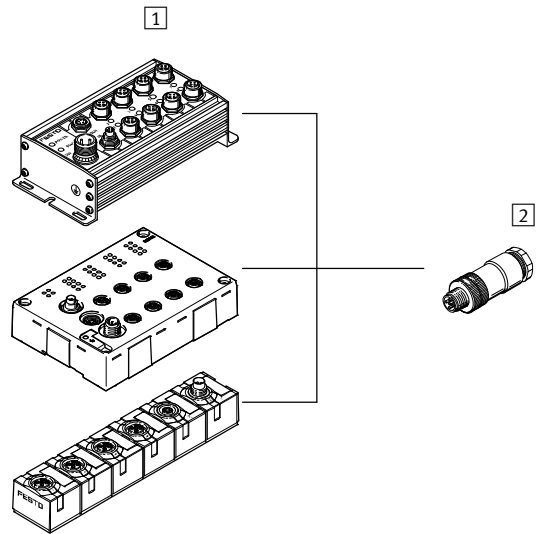

1 Output modules	
Type	
CP-A08N-M12	

Plug connector/connecting cable	
Type	Connection technology
2 Connecting cable	
KM12-M12-...	Socket M12, 4-pin
3 Plug connector	
SEA-GS-7	Screw terminal
SEA-4GS-7-2,5	Screw terminal

1 Output modules	
Type	
CP-A08-M12-5POL	
CP-A08-M12-EL-Z	
CP-A04-M12-CL	

2 Plug connector	
Type	Connection technology
SEA-M12-5GS-PG7	Screw terminal
SEA-5GS-11-DUO	Screw terminal

CPI installation system

Technical data – Input modules CP-E16



Function

Digital input modules facilitate the connection of proximity sensors or other 24 V DC sensors (inductive, capacitive, etc.). M12 plugs with double allocation are separated using a DUO plug or DUO cable.

Application

- Input modules for 24 V DC sensor signals
- M8 and M12 plugs, single allocation connection technology with 16 connections, double allocation connection technology with 8 connections
- M12 plug, 5-pin
- The input statuses are indicated for each input signal on an assigned LED
- 24 V DC supply provided for all connected sensors
- Diagnostic LED for short circuit/undervoltage of sensor supply
- Diagnostic LED for short circuit/interruption of external sensor supply with CP-E-16-M8-Z



General technical data					
Type		CP-E16-M8 positive switching	CP-E16N-M8 negative switching	CP-E16-M12x2-5POL positive switching	
No. of inputs		16			
Allocation of inputs		Single allocation		Double allocation	
Sensor connection type		16x M8, 3-pin		8x M12, 5-pin	
Power supply 24 V DC		Coming from bus node			
Intrinsic current consumption of electronics	[mA]	40	90		
Input current at 24 V DC (from sensor)	[mA]	Typically 8		Typically 6	
Fuse protection for sensors and electronic module		Internal electronic short circuit protection			
Max. current consumption of sensor supply, residual current	[A]	Max. 0.5			
Supply voltage of sensors	[V]	24 DC ±25%			
Protection against polarity reversal		For logic and sensor voltage			
Galvanic isolation		None			
Switching level	Signal 0	[V]	≤5	≥-11	≤6
	Signal 1	[V]	≥11	≤-5	≥8.6
Input delay		[ms]	Typically 5		Typically 3
Switching logic			PNP	NPN	PNP
Input characteristic curve			To IEC 1131-2		
Connection to bus node			Via pre-assembled cables		
Protection class to EN 60529			IP65 (when fully plugged in or fitted with protective cover)		
Temperature range	Operation	[°C]	-5 ... +50		
	Storage	[°C]	-20 ... +70		
Material			Die-cast aluminium		
Dimensions		[mm]	148.9 x 66 x 47.9		140.9 x 78 x 55.2
Weight		[g]	400		500

CPI installation system

Technical data – Input modules CP-E16

General technical data				
Type		CP-E16N-M12x2 negative switching	CP-E16-M8-Z positive and negative switching	
No. of inputs		16		
Allocation of inputs		Double allocation	Single allocation	
Sensor connection type		8x M12, 4-pin	16x M8, 3-pin	
Power supply 24 V DC		Coming from bus node	Coming from bus node, connection for additional sensor supply	
Intrinsic current consumption of electronics [mA]		90	40	
Input current at 24 V DC (from sensor) [mA]		Typically 8		
Fuse protection for sensors and electronic module		Internal electronic short circuit protection	Electronic short circuit protection per group	
Max. current consumption of sensor supply, residual current [A]		Max. 0.5	Max. 1 per 8-fold input group	
Supply voltage of sensors [V]		24 DC \pm 25%		
Protection against polarity reversal		For logic and sensor voltage		
Galvanic isolation		None		
Switching level			PNP	NPN
	Signal 0 [V]	\geq 11	\leq 6	\geq -8.6
	Signal 1 [V]	\leq 5	\geq 8.6	\leq -6
Input delay [ms]		Typically 5	Typically 3	
Switching logic		NPN	PNP/NPN	
Input characteristic curve		To IEC 1131-2		
Connection to bus node		Via pre-assembled cables		
Protection class to EN 60529		IP65 (when fully plugged in or fitted with protective cover)		
Temperature range		Operation [°C]	-5 ... +50	
		Storage [°C]	-20 ... +70	
Material		Die-cast aluminium		
Material note		Conforms to RoHS		
Dimensions [mm]		140.9 x 78 x 55.2	216.9 x 66 x 50.6	
Weight [g]		500	420	

Certifications		
	CP-E16N-M... (negative switching)	CP-E16-M...
ATEX category gas	II 3G	
Ex-ignition protection type gas	Ex na II T5 X Gc	
ATEX category dust	II 3D	
EX-ignition protection type dust	Ex tc IIIC T80° C X Dc IP65	
ATEX ambient temperature [°C]	$-5 \leq T_a \leq +50$	
CE mark (see declaration of conformity)	To EU EMC Directive ¹⁾	
	To EU Explosion Protection Directive (ATEX)	
Certification	c UL us recognized (OL)	
	-	C-Tick

1) For information about the applicability of the component see the manufacturer's EC declaration of conformity at: www.festo.com/sp → User documentation.
If the component is subject to restrictions on usage in residential, office or commercial environments or small businesses, further measures to reduce the emitted interference may be necessary.

CPI installation system

Technical data – Input modules CP-E16

Connection and display components

CP-E16-M12x2-5POL and CP-E16N-M12x2

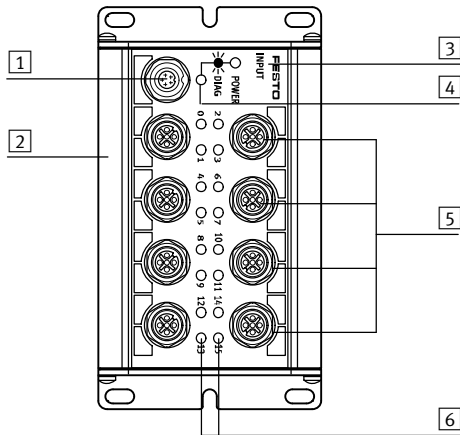

- 1 CP connection
- 2 Slot for inscription labels (ISB 6x10)
- 3 Identification of input type:
-INPUT-P for PNP inputs
-INPUT-N for NPN inputs
- 4 Status LED (green)
- 5 Sensor connections
- 6 Green LED for status display (one LED per input)

Pin allocation for sensor connections CP-E16-M12x2-5POL

Pin allocation	Pin	Signal	Description	Pin	Signal
	1	24 V	Operating voltage 24 V	1	24 V
	2	Ix+1*	Sensor signal	2	Ix+3*
	3	0 V	Operating voltage 0 V	3	0 V
	4	Ix*	Sensor signal	4	Ix+2*
	5	Ground	Earth terminal	5	Ground

Pin allocation for sensor connections CP-E16...-M12x2

Pin allocation	Pin	Signal	Description	Pin	Signal
	1	24 V	Operating voltage 24 V	1	24 V
	2	Ix+1*	Sensor signal	2	Ix+3*
	3	0 V	Operating voltage 0 V	3	0 V
	4	Ix*	Sensor signal	4	Ix+2*

* Ix = Input x

CPI installation system

Technical data – Input modules CP-E16

Connection and display components

CP-E16-M8-Z

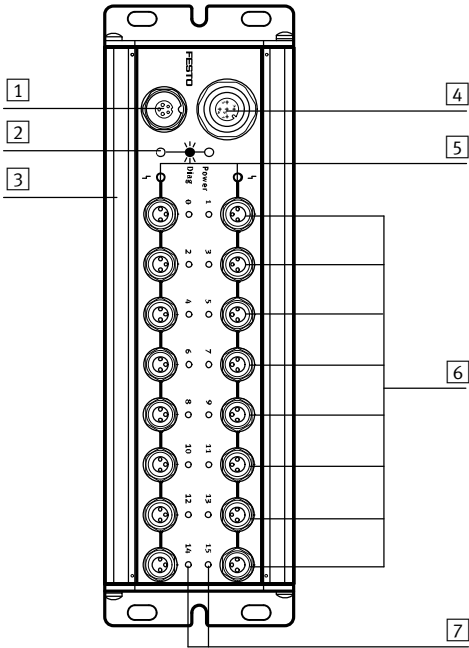

- 1 CP connection
- 2 Status LED (green)
- 3 Slot for inscription labels (ISB 6x10)
- 4 Connection for sensor supply
- 5 Red LED for short circuit display or sensor voltage failure (one LED per input group)
- 6 Sensor connections
- 7 Green LED for status display (one LED per input)

Pin allocation for external sensor supply CP-E16-M8-Z

Pin allocation	Pin	Signal	Description	
	1	24 V DC ±25%	Operating voltage	<p>- - Note</p> <p>External sensor supply for CP-E16-M8-Z: Specified for PNP or NPN operation (type CP-E16-M8-Z). The input module provides PNP or NPN inputs. The setting for PNP or NPN operation is made by installing a bridge in the socket of the sensor supply connection.</p>
	2	PNP/NPN	Coding with negative/positive switching: – PNP operation (pin 2 and 3 bridged) – NPN operation (pin 2 and 1 bridged)	
	3	0 V	Operating voltage 0 V	
	4	n.c.	Not connected	
	5	Ground	Earth terminal	

Pin allocation for sensor connections CP-E16...-M8 and CP-E16-M8-Z

Pin allocation	Pin	Signal	Description	Pin	Signal
	1	24 V	Operating voltage 24 V	1	24 V
	3	0 V	Operating voltage 0 V	3	0 V
	4	Ix*	Sensor signal	4	Ix+1*

* Ix = Input x

CPI installation system

Technical data – Input modules CP-E16

Connection and display components

CP-E16-M8 and CP-E16N-M8

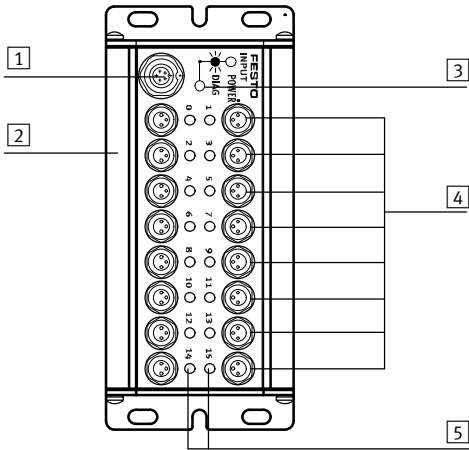

- 1 CP connection
- 2 Slot for inscription labels (ISB 6x10)
- 3 Status LED (green)
- 4 Sensor connections
- 5 Green LED for status display (one LED per input)

Pin allocation for sensor connections CP-E16...-M8 and CP-E16-M8-Z





Pin allocation	Pin	Signal	Description	Pin	Signal
	1	24 V	Operating voltage 24 V	1	24 V
	3	0 V	Operating voltage 0 V	3	0 V
	4	Ix*	Sensor signal	4	Ix+1*

* Ix = Input x

CPI installation system

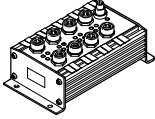
Accessories – Input modules CP-E16

FESTO

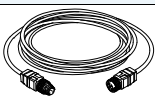
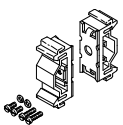
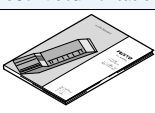
Ordering data				
Designation			Part No.	Type
Input modules				
	positive switching		18205	CP-E16-M8
	negative switching		18243	CP-E16N-M8
	positive switching		175561	CP-E16-M12x2-5POL
	negative switching		18244	CP-E16N-M12x2
	positive and negative switching		189670	CP-E16-M8-Z
Power supply				
	Power supply socket, straight, M12x1, 5-pin		18324	FBSD-GD-9-5POL
Sensor plugs				
	Plug, straight socket, M12	5-pin, PG7	175487	SEA-M12-5GS-PG7
		4-pin, PG7	18666	SEA-GS-7
		4-pin, 2.5 mm ² O.D.	192008	SEA-4GS-7-2,5
	Plug, straight, M8	3-pin, solderable	18696	SEA-GS-M8
		3-pin, screw-in	192009	SEA-3GS-M8-S
	Plug for 2 sensor cables, M12, PG11	4-pin	18779	SEA-GS-11-DUO
		5-pin	192010	SEA-5GS-11-DUO
Sensor cables				
	Connecting cable, M12, 4-pin, straight plug-straight socket	2.5 m	18684	KM12-M12-GSGD-2,5
		5.0 m	18686	KM12-M12-GSGD-5
	Connecting cable, M12, 4-pin, straight plug-angled socket	1.0 m	185499	KM12 M12-GSWD-1-4
	Connecting cable, M8, straight plug-straight socket	0.5 m	175488	KM8-M8-GSGD-0,5
		1.0 m	175489	KM8-M8-GSGD-1
		2.5 m	165610	KM8-M8-GSGD-2,5
		5.0 m	165611	KM8-M8-GSGD-5
Mounting				
	Mounting for H-rail		170169	CP-TS-HS35
User documentation				
	User documentation for input/output modules	German	165125	P.BE.-CPEA-DE
		English	165225	P.BE.-CPEA-EN
		French	165127	P.BE.-CPEA-FR
		Italian	165157	P.BE.-CPEA-IT
		Spanish	165227	P.BE.-CPEA-ES

CPI installation system

Technical data – Input modules CP-E...-EL

Function

Digital input modules facilitate the connection of proximity sensors or other 24 V DC sensors (inductive, capacitive, etc.). Plugs with double allocation are separated using a DUO plug or DUO cable.

Application

- Input modules for 24 V DC sensor signals
- M8 and M12 connection technology
- Display of the input statuses for each input signal via an assigned LED
- Operating voltage supply 24 V DC for all connected sensors
- Diagnostic LED for short circuit/overload of sensor supply
- Circumferential labelling with large, hinged inscription label
- Earthing plate and H-rail mounting already integrated

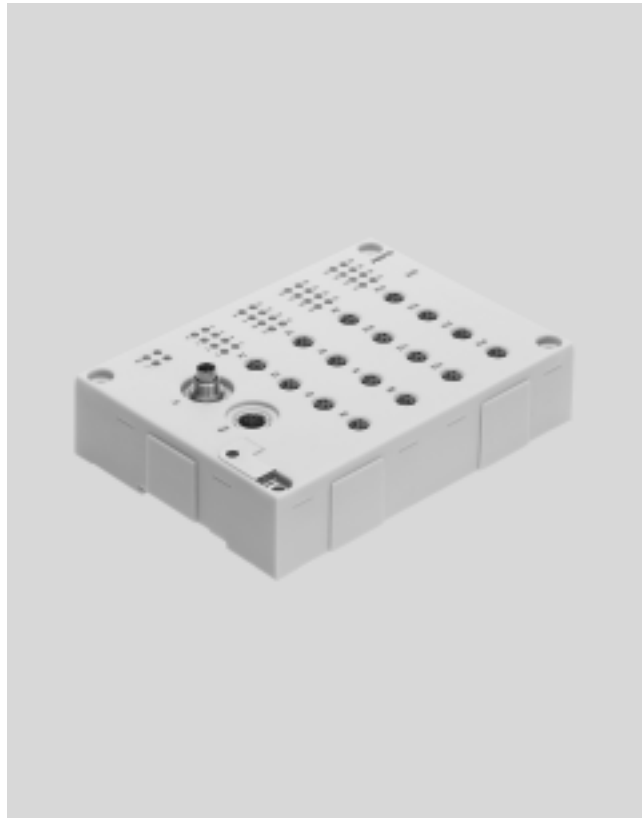

General technical data			
Type	CP-E16-M12-EL positive switching	CP-E16-M8-EL positive switching	CP-E32-M8-EL positive switching
No. of inputs	16		32
Allocation of inputs	Double allocation	Single allocation	Double allocation
Sensor connection type	8x M12, 5-pin	16x M8, 3-pin	16x M8, 4-pin
Power supply 24 V DC	Via CP connection		
Intrinsic current consumption at operating voltage	[mA] Typically 75 mA		
Fuse (short circuit)	Internal electronic fuse protection for each group		Internal electronic fuse
Max. residual current per module	[A] 0.7		1.4
Nominal operating voltage	24		
Operating voltage range	[V DC] 18 ... 30		
Residual ripple, load voltage	[Vss] 4		
Electrical isolation, channel – channel	None		
Switching level	Signal 0	[V] ≤ 6	
	Signal 1	[V] ≥ 8.6	
Debounce time at inputs	[ms] 3 ms (0.5 ms, 10 ms, 20 ms, parameterisable)		
Switching logic	PNP		
Input characteristic curve	To IEC 1131-T2		
Connection to bus node	Via pre-assembled cables		
Diagnostics	CP communication		
	Short circuit/overload		
	Undervoltage		
LEDs	2 Module diagnostics		2 Module diagnostics
	16 Channel status		32 Channel status
	4 Group diagnostics		–

CPI installation system

Technical data – Input modules CP-E...-EL

FESTO

Materials	
Housing	Reinforced polyamide
Cap	Reinforced polyamide
Note on materials	Conforms to RoHS

Operating and environmental conditions	
Protection class to EN 60529	IP65, IP67 (when fully plugged in or fitted with protective cover)
Ambient temperature [°C]	–5 ... +50
Storage temperature [°C]	–20 ... +70
Corrosion resistance class CRC ¹⁾	1
CE mark (see declaration of conformity)	In accordance with EU EMC directive ²⁾
Certification	c UL us listed (OL)
	C-Tick

- 1) Corrosion resistance class 1 to Festo standard 940 070
Components requiring low corrosion resistance. Transport and storage protection. Parts that do not have primarily decorative surface requirements, e.g. in internal areas that are not visible or behind covers.
- 2) For information about the applicability of the component see the manufacturer's EC declaration of conformity at: www.festo.com/sp → User documentation.
If the component is subject to restrictions on usage in residential, office or commercial environments or small businesses, further measures to reduce the emitted interference may be necessary.

CPI installation system

Technical data – Input modules CP-E...-EL

Connection and display components

CP-E16-M12-EL

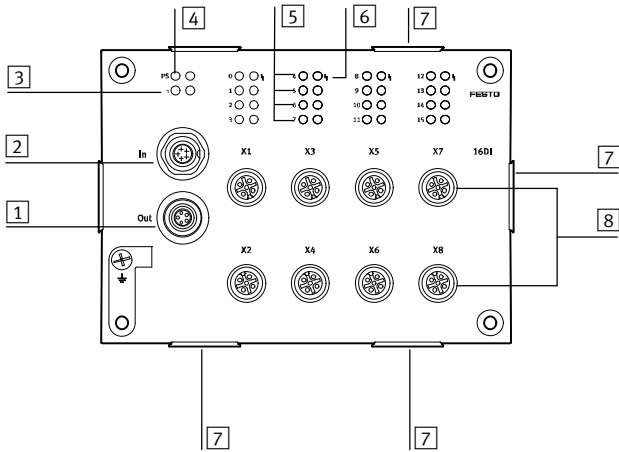

- 1 CP connection, outgoing
- 2 CP connection, incoming
- 3 Status LED (module) for short circuit/overload of sensor supply (red)
- 4 Status LED for CP communication (green)
- 5 Status LEDs for inputs (status display, green)
- 6 Status LED (group) for short circuit/overload of sensor supply (red)
- 7 Fixture for inscription label holder ASCF-H-E2
- 8 Sensor connections (2 inputs per socket)

Pin allocation for sensor connections CP-E16-M12-EL

Pin allocation	Pin	Signal	Description
	1	24 V	Operating voltage 24 V
	2	Ix+1*	Sensor signal
	3	0 V	Operating voltage 0 V
	4	Ix*	Sensor signal
	5	Ground	Earth terminal

* Ix = Input x

CPI installation system

Technical data – Input modules CP-E...-EL

Connection and display components

CP-E16-M8-EL

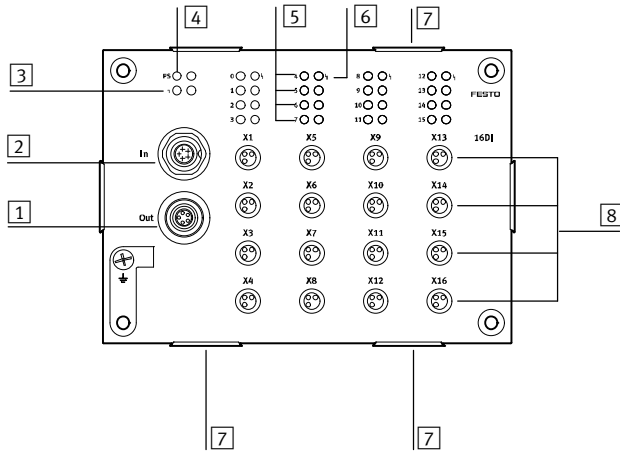

- 1 CP connection, outgoing
- 2 CP connection, incoming
- 3 Status LED (module) for short circuit/overload of sensor supply (red)
- 4 Status LED for CP communication (green)
- 5 Status LEDs for inputs (status display, green)
- 6 Status LED (group) for short circuit/overload of sensor supply (red)
- 7 Fixture for inscription label holder ASCF-H-E2
- 8 Sensor connections (1 input per socket)

Pin allocation for sensor connections CP-E16-M8-EL

Pin allocation	Pin	Signal	Description
	1	24 V	Operating voltage 24 V
	3	0 V	Operating voltage 0 V
	4	Ix*	Sensor signal

* Ix = Input x

CPI installation system

Technical data – Input modules CP-E...-EL

Connection and display components

CP-E32-M8-EL

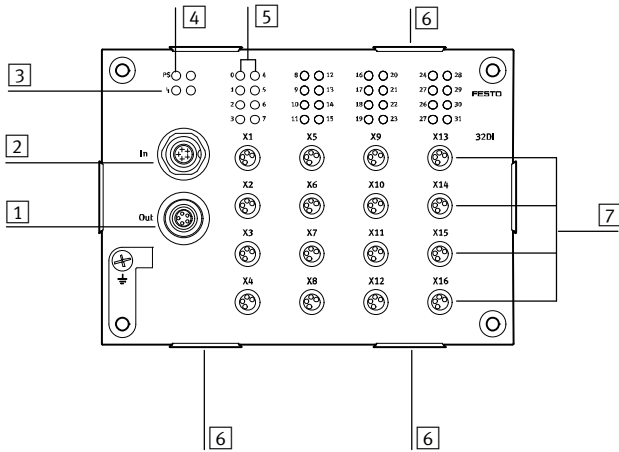

- 1 CP connection, outgoing
- 2 CP connection, incoming
- 3 Status LED (module) for short circuit/overload of sensor supply (red)
- 4 Status LED for CP communication (green)
- 5 Status LEDs for inputs (status display, green)
- 6 Fixture for inscription label holder ASCF-H-E2
- 7 Sensor connections (2 inputs per socket)





Pin allocation for sensor connections CP-E32-M8-EL

Pin allocation	Pin	Signal	Description
	1	24 V	Operating voltage 24 V
	2	I _{x+1} *	Sensor signal
	3	0 V	Operating voltage 0 V
	4	I _x *	Sensor signal

* I_x = Input x

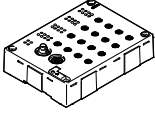
CPI installation system

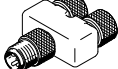
Accessories – Input modules CP-E...-EL

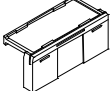
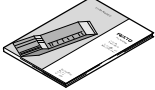
Ordering data				
Designation			Part No.	Type
Input modules				
	positive switching		546923	CP-E16-M12-EL
	positive switching		546922	CP-E16-M8-EL
	positive switching		546921	CP-E32-M8-EL
Plug connectors				
	Straight plug, M12	5-pin, PG7	175487	SEA-M12-5GS-PG7
		4-pin, PG7	18666	SEA-GS-7
		4-pin, 2.5 mm ² O.D.	192008	SEA-4GS-7-2,5
	Straight plug, M8	3-pin, solderable	18696	SEA-GS-M8
		3-pin, screw-in	192009	SEA-3GS-M8-S
	Plug for 2 cables, M12, PG11	4-pin	18779	SEA-GS-11-DUO
		5-pin	192010	SEA-5GS-11-DUO
	Push-in T-connector	2x socket M8, 3-pin 1x plug M8, 4-pin	544391	NEDU-M8D3-M8T4
		Push-in T-connector	2x socket M12, 5-pin 1x plug M12, 4-pin	541596
Connecting cables				
	DUO cable, 1x straight plug M8, 4-pin	2x straight socket M8	574591	NEDU-L2R1-M8G3-K-1L1-1L2-M8G4
	DUO cable, 1x straight plug M12	2x straight socket M8	18685	KM12-DUO-M8-GDGD
		1x straight socket M8 and 1x angled socket M8	18688	KM12-DUO-M8-GDWD
		2x angled socket M8	18687	KM12-DUO-M8-WDWD
Inscription label holders				
	Inscription label holders for EL modules, bag of 10		547473	ASCF-H-E2
User documentation				
	User documentation for input/output modules	German	539299	P.BE.-CPEA-CL-DE
		English	539300	P.BE.-CPEA-CL-EN
		French	539302	P.BE.-CPEA-CL-FR
		Italian	539303	P.BE.-CPEA-CL-IT
		Spanish	539301	P.BE.-CPEA-CL-ES

CPI installation system

Technical data – Input modules CP-E...-CL

Function

Digital input modules facilitate the connection of proximity sensors or other 24 V DC sensors (inductive, capacitive, etc.). Plugs with double allocation are separated using a DUO plug or DUO cable.

Application

- Input modules for 24 V DC sensor signals
- M8 and M12 plug connection technology
- M12 input module, inputs with double allocation. M8 inputs with single allocation
- M12 plug, 5-pin
- The input statuses are indicated for each input signal on an assigned LED
- 24 V DC supply provided for all connected sensors
- Diagnostic LED for short circuit/undervoltage of sensor supply
- Modules support the CPI functionality (only in combination with the CPX CP interface)



General technical data				
Type		CP-E08-M12-CL positive switching	CP-E08-M8-CL positive switching	CP-E16-KL-CL positive switching
No. of inputs		8		16
Allocation of inputs		Double allocation	Single allocation	
Sensor connection type		4x M12, 5-pin	8x M8, 3-pin	Spring-loaded terminals or screw terminals
Power supply 24 V DC		From the bus node, basic unit, CP interface, etc.		
Intrinsic current consumption of electronics	[mA]	Typically 35 (inputs not connected)		
Input current at 24 V DC (from sensor)	[mA]	Typically 6		
Fuse protection for sensors and electronic module		Internal electronic short circuit protection		
Max. current consumption of sensor supply, residual current	[A]	Max. 0.8		
Nominal operating voltage for sensors		24		
Operating voltage range for sensors	[V DC]	18 ... 30		
Protection against polarity reversal		For logic and sensor supply		
Galvanic isolation		None		
Switching level	Signal 0	[V]	≤5	
	Signal 1	[V]	≥-11	
Input delay		[ms]	Typically 3	
Switching logic			PNP	
Input characteristic curve			To IEC 11 31-2	
Connection to bus node			Via pre-assembled cables	
Diagnostics			Undervoltage	
			Short circuit/overload of sensor supply	

CPI installation system

Technical data – Input modules CP-E...-CL

FESTO

General technical data				
Type		CP-E08-M12-CL positive switching	CP-E08-M8-CL positive switching	CP-E16-KL-CL positive switching
Material note		Conforms to RoHS		
Dimensions (WxLxH)	[mm]	151 x 30 x 25		
Weight	[g]	165	190	145

Operating conditions				
Type		CP-E08-M12-CL	CP-E08-M8-CL	CP-E16-KL-CL
Protection class to EN 60529		IP65/IP67 (when fully plugged in or fitted with protective cap)		IP20
Ambient temperature	[°C]	-5 ... +50		
Storage temperature	[°C]	-20 ... +70		
Corrosion resistance class CRC ¹⁾		1		
CE mark (see declaration of conformity)		To EU EMC Directive ²⁾		
		To EU Explosion Protection Directive (ATEX)		-
Certification		c UL us - Listed (OL)		
		C-Tick		

- 1) Corrosion resistance class 1 to Festo standard 940 070
Components requiring low corrosion resistance. Transport and storage protection. Parts that do not have primarily decorative surface requirements, e.g. in internal areas that are not visible or behind covers.
- 2) For information about the applicability of the component see the manufacturer's EC declaration of conformity at: www.festo.com/sp → User documentation.
If the component is subject to restrictions on usage in residential, office or commercial environments or small businesses, further measures to reduce the emitted interference may be necessary.

Certifications ATEX				
Type		CP-E08-M12-CL	CP-E08-M8-CL	CP-E16-KL-CL
ATEX category gas		II 3G		-
Ex-ignition protection type gas		Ex nA IIC T6 X Gc		-
ATEX category dust		II 3D		-
EX-ignition protection type dust		Ex tc IIIC T70°C X Dc IP67		-
ATEX ambient temperature	[°C]	-5 ≤ Ta ≤ +50		-

 Note

If device combinations are operated in potentially explosive areas, the lowest common zone, the temperature class as well as the ambient temperature of the individual devices determine the possible use of the complete module.

CPI installation system

Technical data – Input modules CP-E...-CL

Connection and display components

CP-E08-M12-CL

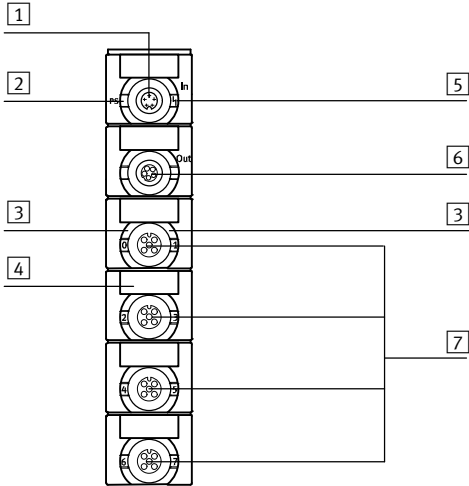

- 1 CP connection, incoming
- 2 Status LED (green)
- 3 Green LED for status display (one LED per input)
- 4 Holder for inscription label (IBS 8x20)
- 5 Red LED for short circuit/overload indication
- 6 CP connection, outgoing
- 7 Sensor connections

Pin allocation for sensor connections CP-E08-M12-CL

Pin allocation	Pin	Signal	Description
	1	24 V	Operating voltage 24 V
	2	Ix+1*	Sensor signal
	3	0 V	Operating voltage 0 V
	4	Ix*	Sensor signal
	5	Ground	Earth terminal

* Ix = Input x

CPI installation system

Technical data – Input modules CP-E...-CL

Connection and display components

CP-E08-M8-CL

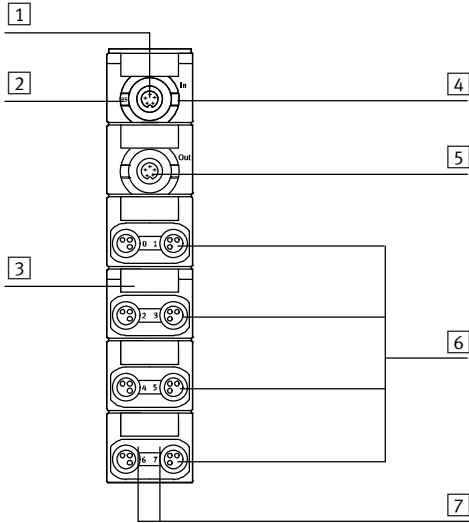

- 1 CP connection, incoming
- 2 Status LED (green)
- 3 Holder for inscription label (IBS 8x20)
- 4 Red LED for short circuit/overload indication
- 5 CP connection, outgoing
- 6 Sensor connections
- 7 Green LED for status display (one LED per input)

Pin allocation for sensor connections CP-E08-M8-CL

Pin allocation	Pin	Signal	Description	Pin	Signal
	1	24 V	Operating voltage 24 V	1	24 V
	3	0 V	Operating voltage 0 V	3	0 V
	4	Ix*	Sensor signal	4	Ix+1*

* Ix = Input x

CPI installation system

Technical data – Input modules CP-E...-CL

Connection and display components

CP-E16-KL-CL

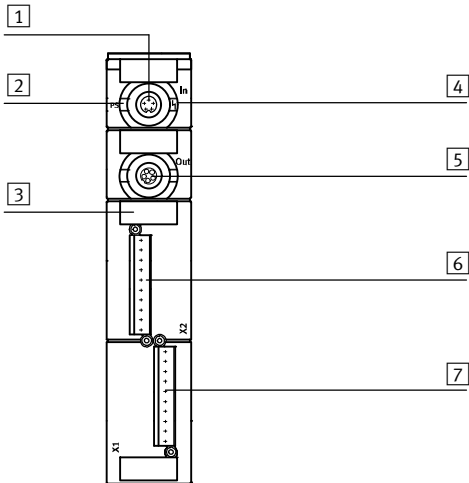

- 1 CP connection, incoming
- 2 Status LED (green)
- 3 Holder for inscription label (IBS 8x20)
- 4 Red LED for short circuit/overload indication
- 5 CP connection, outgoing
- 6 Sensor connections, plug X2
- 7 Sensor connections, plug X1

Pin allocation for sensor supply CP-E16-KL-CL

Pin allocation	Pin	Signal	Description	Pin	Signal	
	Plug X1			Plug X2		
	+	24 V DC	Operating voltage	+	24 V DC	Note 8 sensors can be connected to each of the connections X1 and X2. When using the three-row plug PS1-SAC30-30POL or PS1-SAC31-30POL+LED, it is possible to use the second and third contact bank for the sensor power supply via a bridge.
	0	I 0	Connections for sensors	0	I 8	
	1	I 1		1	I 9	
	2	I 2		2	I 10	
	3	I 3		3	I 11	
	4	I 4		4	I 12	
	5	I 5		5	I 13	
	6	I 6		6	I 14	
	7	I 7		7	I 15	
-	0 V DC		-	0 V DC		







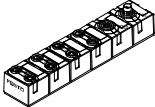

Plug connection for power supply for sensors (PS1-SAC31-30POL+LED)

	Connection row 0		Connection row 1		Connection row 2	
	-	0 V DC	Operating voltage	-	n.c.	-
7	I x+7	Connections for sensors	7	24 V DC	7	0 V DC
6	I x+6		6			
5	I x+5		5			
4	I x+4		4			
3	I x+3		3			
2	I x+2		2			
1	I x+1		1			
0	I x		0			
+	24 V DC	Operating voltage	+	Jumper	+	n.c.

CPI installation system

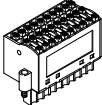
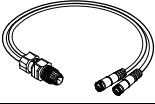
Accessories – Input modules CP-E...-CL

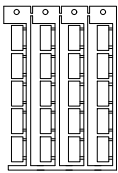
FESTO

Ordering data				
Designation			Part No.	Type
Input modules				
	positive switching		538787	CP-E08-M12-CL
	positive switching		538788	CP-E08-M8-CL
	positive switching		538789	CP-E16-KL-CL
Sensor plugs				
	Plug, straight socket, M12	5-pin, PG7	175487	SEA-M12-5GS-PG7
		4-pin, PG7	18666	SEA-GS-7
		4-pin, 2.5 mm ² O.D.	192008	SEA-4GS-7-2,5
	Straight plug, M8	3-pin, solderable	18696	SEA-GS-M8
		3-pin, screw-in	192009	SEA-3GS-M8-S
	Plug for 2 sensor cables, M12, PG11	4-pin	18779	SEA-GS-11-DUO
		5-pin	192010	SEA-5GS-11-DUO
Connection sets for sensors				
	Plug, screw-in tension-spring socket with LED	3-row, 30-pin	197162	PS1-SAC31-30POL+LED
Cables				
	DUO cable	2x straight socket	18685	KM12-DUO-M8-GDGD
		2x straight/angled socket	18688	KM12-DUO-M8-GDWD
		2x angled socket	18687	KM12-DUO-M8-WDWD
	Connecting cable, M12, 4-pin, straight plug-straight socket	2.5 m	18684	KM12-M12-GSGD-2,5
		5.0 m	18686	KM12-M12-GSGD-5
Inscription labels				
	Inscription labels 8x20 mm in frames (20 pieces)		539388	IBS-8x20
User documentation				
	User documentation for input/output modules	German	539299	P.BE.-CPEA-CL-DE
		English	539300	P.BE.-CPEA-CL-EN
		French	539302	P.BE.-CPEA-CL-FR
		Italian	539303	P.BE.-CPEA-CL-IT
		Spanish	539301	P.BE.-CPEA-CL-ES

CPI installation system

Technical data – Output modules CP-A08

Function

The electrical outputs activate actuators such as individual valves, lamps, signal equipment and many more.

-  - Note
Optimum actuation of valves with M12 central plug.

Application

- Output module with 8 outputs 24 V DC
- M12 connection technology, with 4- or 5-pin sockets
- LED display of the switching status per channel
- Short circuit and overload detection
- Malfunction display by means of green LED



General technical data			
Type		CP-A08-M12-5POL positive switching	CP-A08N-M12 negative switching
No. of outputs		8	
Allocation of outputs		Single allocation	
Output connection type		8x M12, 5-pin	8x M12, 4-pin
Load voltage connection		M18, 4-pin	
Bus connection		2 plugs M9, 5-pin, via prefabricated cables	
Max. output current per channel	[A]	0.5	
Operating voltage	[V DC]	24 ±25%	
Load voltage connection	[V DC]	24 ±25%, protected against incorrect polarity	
Fuse protection for power output	[A]	Electronic fuse per output 0.5	
Intrinsic current consumption, electronics	[mA]	Max. 90	
Overload/short circuit protection		Per channel	
Switching logic		PNP to IEC 1131-2	NPN to IEC 1131-2
Protection class to EN 60529		IP65 (when fully plugged-in or fitted with protective cover)	
Temperature range	Operation	[°C] -5 ... +50	
	Storage	[°C] -20 ... +70	
Material		Die-cast aluminium	
Dimensions (L x W x D)		[mm]	172.9 x 78 x 57.1
Weight		[g]	500

CPI installation system

Technical data – Output modules CP-A08

Certifications	
ATEX category gas	II 3G
Ex-ignition protection type gas	Ex na IIC T5 X Gc
ATEX category dust	II 3D
EX-ignition protection type dust	Ex tc IIIC T80° C X Dc IP65
ATEX ambient temperature	[°C] $-5 \leq T_a \leq +50$
CE mark (see declaration of conformity)	To EU EMC Directive ¹⁾
	To EU Explosion Protection Directive (ATEX)
Certification	c UL us recognized (OL)

1) For information about the applicability of the component see the manufacturer's EC declaration of conformity at: www.festo.com/sp → User documentation.
If the component is subject to restrictions on usage in residential, office or commercial environments or small businesses, further measures to reduce the emitted interference may be necessary.

Connection and display components

CP-A08-M12...

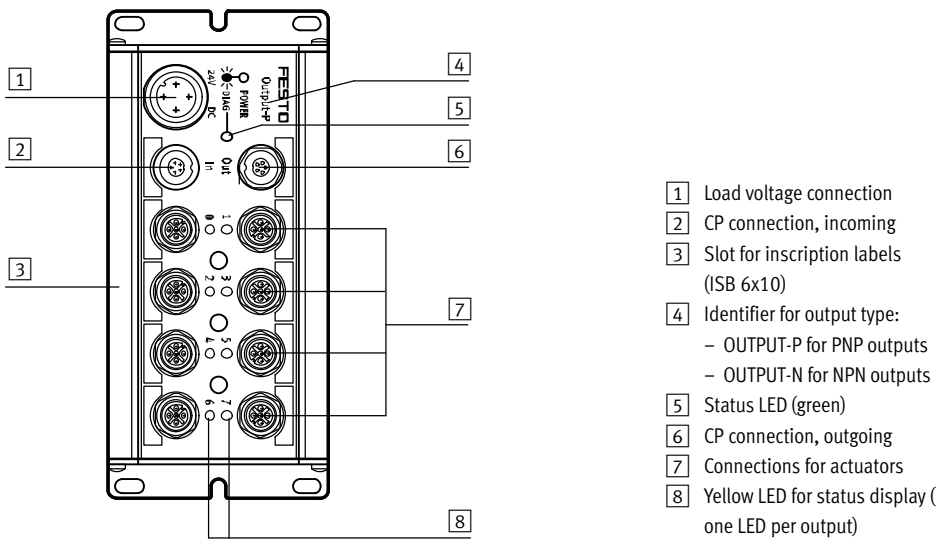

- 1 Load voltage connection
- 2 CP connection, incoming
- 3 Slot for inscription labels (ISB 6x10)
- 4 Identifier for output type:
 - OUTPUT-P for PNP outputs
 - OUTPUT-N for NPN outputs
- 5 Status LED (green)
- 6 CP connection, outgoing
- 7 Connections for actuators
- 8 Yellow LED for status display (one LED per output)

Pin allocation for load voltage connection CP-A08-M12...			
Connection allocation	Pin	Signal	Designation
	1	n.c.	Not connected
	2	24 V DC ±25%	Operating voltage
	3	0 V	Operating voltage 0 V
	4	FE (earth)	Protective earth

CPI installation system

Technical data – Output modules CP-A08









Pin allocation for outputs						
Terminal allocation	Pin	Signal	Designation	Pin	Signal	
CP-A08-M12-5POL (PNP outputs)						
	1	n.c.	Not connected	1	n.c.	<p>Note</p> <p>Two outputs can be connected to output sockets 0, 2, 4 and 6 of the CP output module by means of internal connection between pin 2 of the even numbered output and pin 4 of the opposite odd numbered output.</p>
	2	Ox+1	Connected with pin 4 of plug 2/ not connected	2	n.c.	
	3	0 V	Reference potential	3	0 V	
	4	Ox	Output/connected with pin 2 of plug 1	4	Ox+1	
	5	Load	Earth terminal	5	Load	
CP-A08-M12 (NPN outputs)						
	1	24 V DC	Operating voltage	1	24 V DC	<p>Note</p> <p>The consuming devices/load must be supplied with a 24 V operating voltage via pin 1.</p>
	2	FE (earth)	Earth terminal	2	FE (earth)	
	3	n.c.	Not connected	3	n.c.	
	4	Ox	Output	4	Ox+1	

* Ox = Output x

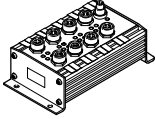
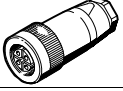
CPI installation system

Accessories – Output modules CP-A08

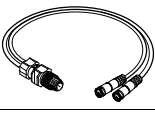
FESTO

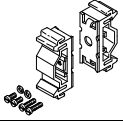
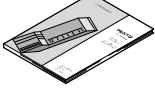
Ordering data				
Designation			Part No.	Type
Output modules				
	positive switching		175640	CP-A08-M125POL
	negative switching		18234	CP-A08N-M12
Power supply				
	Power supply socket, straight, M18x1, 4-pin	for 1.5 mm ²	18493	NTSD-GD-9
		for 2.5 mm ²	18526	NTSD-GD-13,5
	Power supply socket, angled, M18x1, 4-pin	for 1.5 mm ²	18527	NTSD-WD-9
		for 2.5 mm ²	533119	NTSD-WD-11
Sensor plugs				
	Plug, straight socket, M12	5-pin, PG7	175487	SEA-M12-5GS-PG7
		4-pin, PG7	18666	SEA-GS-7
		4-pin, 2.5 mm ² OD	192008	SEA-4GS-7-2,5
	Plug for 2 sensor cables, M12, PG11	4-pin	18779	SEA-GS-11-DUO
		5-pin	192010	SEA-5GS-11-DUO
Cables				
	DUO cable	2x straight socket	18685	KM12-DUO-M8-GDGD
		2x straight/angled socket	18688	KM12-DUO-M8-GDWD
		2x angled socket	18687	KM12-DUO-M8-WDWD
	Connecting cable, M12, 4-pin, straight plug-straight socket	2.5 m	18684	KM12-M12-GSGD-2,5
		5.0 m	18686	KM12-M12-GSGD-5
Mounting				
	Mounting for H-rail		170169	CP-TS-HS35
User documentation				
	User documentation for input/output modules	German	165125	P.BE.-CPEA-DE
		English	165225	P.BE.-CPEA-EN
		French	165127	P.BE.-CPEA-FR
		Italian	165157	P.BE.-CPEA-IT
		Spanish	165227	P.BE.-CPEA-ES

CPI installation system

Technical data – Output modules CP-A08-EL

Function

The electrical outputs actuate actuators such as individual valves, lamps, signal equipment and many more.

 **Note**
The output module is ideal for actuation of valves with M12 central plug.

Application

- Output module with 8 outputs 24 V DC
- M12, 5-pin connection technology
- Display of the switching status per channel via LED
- Short circuit and overload detection
- Malfunction display by means of red LED
- Module supports the CPI functionality (only in combination with the CPX CP interface)
- Circumferential labelling with large, hinged inscription label
- Earthing plate and H-rail mounting already integrated

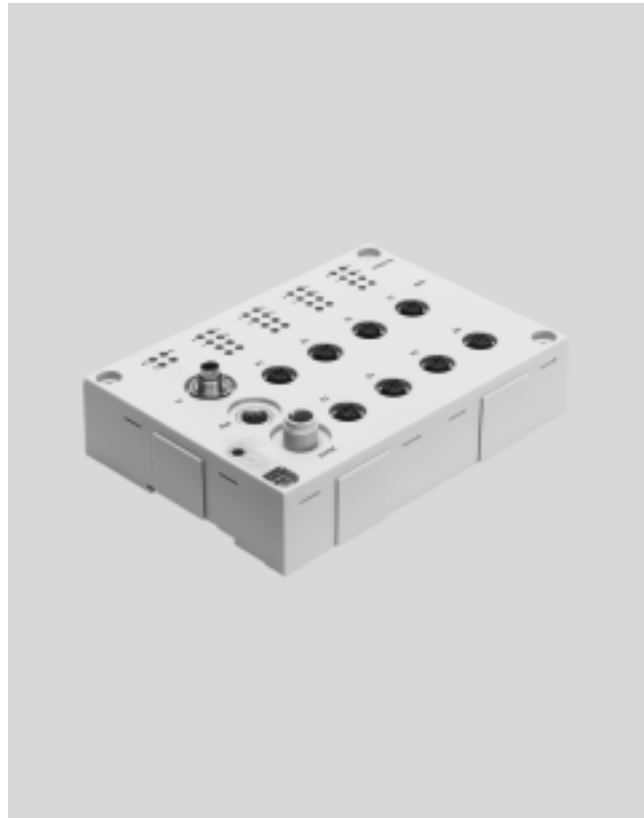

General technical data		CP-A08-M12-EL-Z positive switching
Type		CP-A08-M12-EL-Z positive switching
No. of outputs		8
Allocation of outputs		Connection 1, 3, 5 and 7 with double allocation, connection 2, 4, 6 and 8 with single allocation
Sensor connection type		8x M12, 5-pin
Power supply 24 V DC		M12, 4-pin, A-coded
Intrinsic current consumption at operating voltage	[mA]	Typically 35
Max. residual current per module	[A]	4
Max. output current per channel	[A]	Max. 0.5, max. 2 outputs can be connected in parallel
Nominal operating voltage	[V DC]	24
Operating voltage range	[V DC]	18 ... 30
Residual ripple, load voltage	[Vss]	4
Fuse (short circuit)		Internal electronic fuse protection for each group
Switching logic		PNP
Output characteristic curve		To ICE 1131-T2
Electrical isolation, channel – channel		None
Connection to bus node		Via pre-assembled cables
Diagnostics		CP communication
		Short circuit/overload per channel
		Undervoltage
LEDs		3 Module diagnostics
		8 Channel status
		8 Channel diagnostics

CPI installation system

Technical data – Output modules CP-A08-EL

Materials	
Housing	Reinforced polyamide
Cap	Reinforced polyamide
Note on materials	Conforms to RoHS

Operating and environmental conditions	
Protection class to EN 60529	IP65, IP67 (when fully plugged in or fitted with protective cover)
Ambient temperature [°C]	-5 ... +50
Storage temperature [°C]	-20 ... +70
Corrosion resistance class CRC ¹⁾	1
CE mark (see declaration of conformity)	In accordance with EU EMC directive ²⁾
Certification	c UL us listed (OL) C-Tick

- 1) Corrosion resistance class 1 to Festo standard 940 070
Components requiring low corrosion resistance. Transport and storage protection. Parts that do not have primarily decorative surface requirements, e.g. in internal areas that are not visible or behind covers.
- 2) For information about the applicability of the component see the manufacturer's EC declaration of conformity at: www.festo.com/sp → User documentation.
If the component is subject to restrictions on usage in residential, office or commercial environments or small businesses, further measures to reduce the emitted interference may be necessary.

Connection and display components

CP-A08-M12-EL-Z

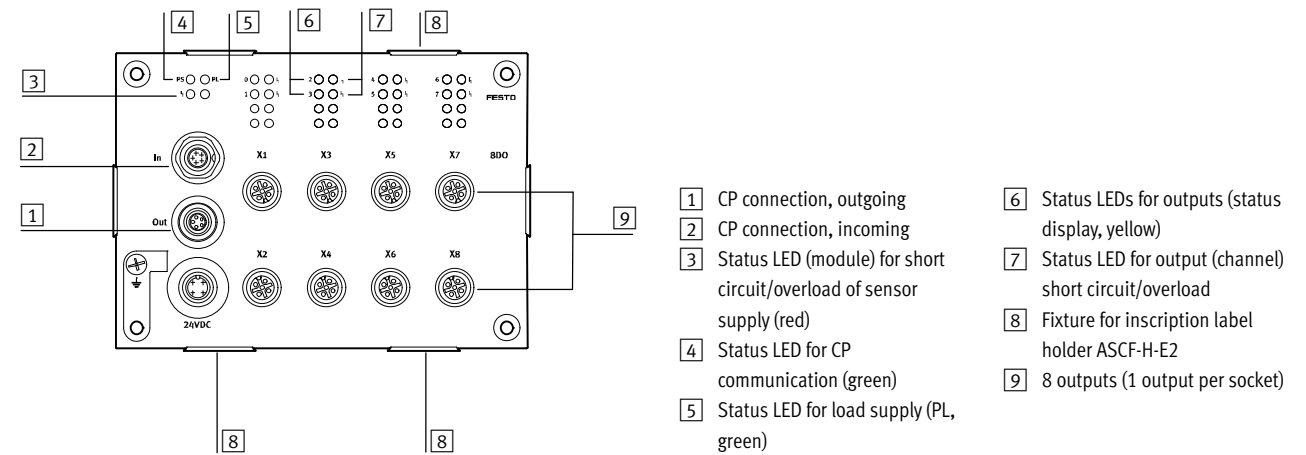

Pin allocation for load voltage connection CP-A08-M12-EL-Z			
Pin allocation	Pin	Signal	Description
	1	n.c.	Not connected
	2	24 V DC ±25%	Operating voltage
	3	0 V	Operating voltage 0 V
	4	FE	Protective earth

CPI installation system

Technical data – Output modules CP-A08-EL



Pin allocation for outputs				
Pin allocation	Output 1, 3, 5 and 7		Description	
	Pin	Signal		
CP-A08-M12-EL-Z (odd number of PNP outputs)				
	1	n.c.	Not connected	<p>Note</p> <p>Two outputs can be connected to output sockets 1, 3, 5 and 7 of the CP output module by means of internal connection between pin 2 of the odd numbered output and pin 4 of the underlying even numbered output.</p>
	2	Ox+1	Connected with pin 4 of output 2	
	3	0 V	Reference potential	
	4	Ox	Output	
	5	FE	Earth terminal	

* Ox = Output x







Pin allocation for outputs			
Pin allocation	Output 2, 4, 6 and 8		Description
	Pin	Signal	
CP-A08-M12-EL-Z (even number of PNP outputs)			
	1	n.c.	Not connected
	2	n.c.	Not connected
	3	0 V	Reference potential
	4	Ox+1	Connected with pin 2 of output 1
	5	FE	Earth terminal

* Ox = Output x

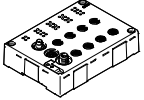
CPI installation system

Accessories – Output modules CP-A08-EL

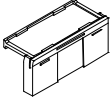
FESTO

Ordering data				
Designation			Part No.	Type
Output modules				
	positive switching		546924	CP-A08-M12-EL-Z
Plug connectors				
	Straight plug, M12	5-pin, PG7	175487	SEA-M12-5GS-PG7
		4-pin, PG7	18666	SEA-GS-7
		4-pin, 2.5 mm ² O.D.	192008	SEA-4GS-7-2,5
	Plug for 2 cables, M12, PG11	4-pin	18779	SEA-GS-11-DUO
		5-pin	192010	SEA-5GS-11-DUO
Connecting cables				
	DUO cable, 1x straight plug M12	2x straight socket M8	18685	KM12-DUO-M8-GDGD
		1x straight socket M8 and 1x angled socket M8	18688	KM12-DUO-M8-GDWD
		2x angled socket M8	18687	KM12-DUO-M8-WDWD
Inscription label holders				
	Inscription label holders for EL modules, bag of 10		547473	ASCF-H-E2
User documentation				
	User documentation for input/output modules	German	539299	P.BE.-CPEA-CL-DE
		English	539300	P.BE.-CPEA-CL-EN
		French	539302	P.BE.-CPEA-CL-FR
		Italian	539303	P.BE.-CPEA-CL-IT
		Spanish	539301	P.BE.-CPEA-CL-ES

CPI installation system

Technical data – Output modules CP-A04

Function

The electrical outputs actuate actuators such as individual valves, lamps, signal equipment and many more.

 Note
Optimum actuation for valves with M12 central plug.

Application

- Output module with 4 outputs 24 V DC
- M12 connection technology, with 5-pin sockets
- LED display of the switching status per channel
- Short circuit and overload detection
- Malfunction display by means of red LED
- Module supports the CPI functionality (only in combination with the CPX CP interface)



General technical data		
Type	CP-A04-M12-CL positive switching	
No. of outputs	4	
Allocation of outputs	Connection 1 and 3 with double allocation, connection 2 and 4 with single allocation	
Sensor connection type	4x M12, 5-pin	
Power supply 24 V DC	From the bus node, basic unit, CP interface, etc.	
Intrinsic current consumption of electronics	[mA]	Typically 35
Max. output current per channel	[A]	Max. 0.5, max. 2 outputs can be connected in parallel
Operating voltage	[V DC]	24 ±25%
Fuse protection for power output	Internal electronic short-circuit protection per output	
Switching logic	PNP	
Output characteristic curve	To ICE 1131-2	
Galvanic isolation	None	
Connection to bus node	Via pre-assembled cables	
Diagnostics	Undervoltage	
	Short circuit at actuator output (per channel)	
Dimensions (LxWxD)	[mm]	151 x 30 x 25
Weight	[g]	165

CPI installation system

Technical data – Output modules CP-A04

Operating conditions	
Protection class to EN 60529	IP65/IP67 (when fully plugged in or fitted with protective cap)
Ambient temperature [°C]	-5 ... +50
Storage temperature [°C]	-20 ... +70
Corrosion resistance class CRC ¹⁾	1
CE mark (see declaration of conformity)	To EU EMC Directive ²⁾
	To EU Explosion Protection Directive (ATEX)
Certification	c UL us - Listed (OL)
	C-Tick

- 1) Corrosion resistance class 1 to Festo standard 940 070
Components requiring low corrosion resistance. Transport and storage protection. Parts that do not have primarily decorative surface requirements, e.g. in internal areas that are not visible or behind covers.
- 2) For information about the applicability of the component see the manufacturer's EC declaration of conformity at: www.festo.com/sp → User documentation.
If the component is subject to restrictions on usage in residential, office or commercial environments or small businesses, further measures to reduce the emitted interference may be necessary.

Certifications ATEX	
ATEX category gas	II 3G
Ex-ignition protection type gas	Ex nA IIC T6 X Gc
ATEX category dust	II 3D
EX-ignition protection type dust	Ex tc IIIC T70°C X Dc IP67
ATEX ambient temperature [°C]	-5 ≤ Ta ≤ +50

 Note

If device combinations are operated in potentially explosive areas, the lowest common zone, the temperature class as well as the ambient temperature of the individual devices determine the possible use of the complete module.

CPI installation system

Technical data – Output modules CP-A04

Connection and display components

CP-A04-M12-CL

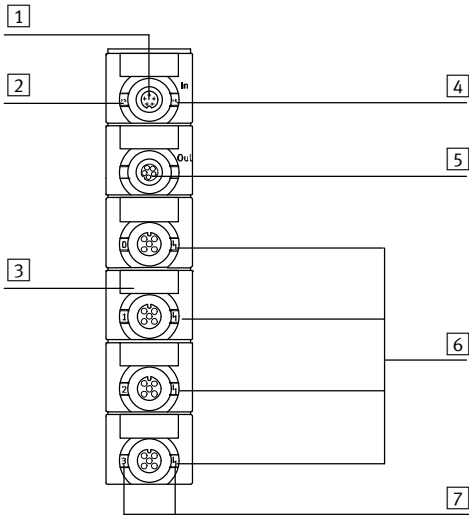

- 1 CP connection, incoming
- 2 Status LED (green)
- 3 Holder for inscription label (IBS 8x20)
- 4 Red LED for short circuit/overload indication
- 5 CP connection, outgoing
- 6 Output
- 7 Green LED for status display (one LED per output)

Pin allocation for outputs





Pin allocation	Output 1 and 3		Description	Output 2 and 4		
	Pin	Signal		Pin	Signal	
CP-A08-M12-5POL (PNP outputs)						
	1	n.c.	Not connected	1	n.c.	<p>Note</p> <p>Two outputs can be connected to output sockets 1 and 3 of the CP output module by means of internal connection between pin 2 of the odd numbered output and pin 4 of the underlying even numbered output.</p>
	2	Ox+1	Connected with pin 4 of plug 2/ not connected	2	n.c.	
	3	0 V	Reference potential	3	0 V	
	4	Ox	Output/connected with pin 2 of plug 1	4	Ox+1	
	5	FE	Earth terminal	5	FE	

* Ox = Output x

CPI installation system

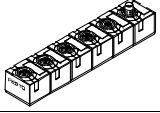
Accessories – Output modules CP-A04

FESTO

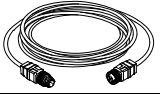
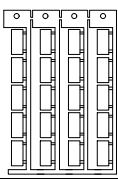
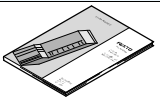
Ordering data				
Designation			Part No.	Type
Output modul				
	Positive switching		538790	CP-A04_M12_CL
Sensor plugs				
	Plug, straight socket, M12	5-pin, PG7	175487	SEA-M12-5GS-PG7
		4-pin, PG7	18666	SEA-GS-7
		4-pin, 2.5 mm ² O.D.	192008	SEA-4GS-7-2,5
	Plug for 2 sensor cables, M12, PG11	4-pin	18779	SEA-GS-11-DUO
		5-pin	192010	SEA-5GS-11-DUO
Cables				
	DUO cable	2x straight socket	18685	KM12-DUO-M8-GDGD
		2x straight/angled socket	18688	KM12-DUO-M8-GDWD
		2x angled socket	18687	KM12-DUO-M8-WDWD
	Connecting cable, M12, 4-pin, straight plug-straight socket	2.5 m	18684	KM12-M12-GSGD-2,5
		5.0 m	18686	KM12-M12-GSGD-5
Inscription labels				
	Inscription labels 8x20 mm in frames (20 pieces)		539388	IBS-8x20
User documentation				
	User documentation for input/output modules	German	539299	P.BE.-CPEA-CL-DE
		English	539300	P.BE.-CPEA-CL-EN
		French	539302	P.BE.-CPEA-CL-FR
		Italian	539303	P.BE.-CPEA-CL-IT
		Spanish	539301	P.BE.-CPEA-CL-ES

CPI installation system

Technical data – MPA-S valve terminals

-  - Flow rate
MPA1: Up to 360 l/min
MPA2: Up to 700 l/min

-  - Valve width
MPA1: 10 mm
MPA2: 21 mm

-  - Voltage
24 V DC

CPI interface for communication between an MPA-S valve terminal and a CPI master. It activates an MPA-S valve terminal with up to 32 solenoid coils on max. 16 valve positions.

-  - Note

With more than 16 MPA2 solenoid coils an additional electrical supply is absolutely necessary (after 4 electronic modules).

Note that without an additional electrical supply maximum 24 solenoid

coils may be switched. If more than 24 MPA1 or 12 MPA2 solenoid coils are to be switched simultaneously, an additional supply must be inserted after the third electronic module.



General technical data			
Type	MPA-CPI-VI		
CP interface, incoming	Plug M9, 5-pin		
CP interface, outgoing	Socket M9, 5-pin		
Max. no. of valve positions	32		
Max. no. of pressure zones	9		
LED display (product-specific)	PS	Common message regarding power supply	
	PL	Power supply for valves	
	Symbol	Module fault	
Nominal operating voltage	[V DC]	24	
Operating voltage range	[V DC]	24 ±25%	
Power failure bridging	Logic side only	[ms]	10
Current consumption at nominal operating voltage	Load	[mA]	Dependent on valve type and number of valves
	Electronics	[mA]	Approx. 50 (plus current consumption of electronic modules)
Residual ripple	[Vss]	4	
Materials	Die-cast aluminium, PA		
Note on materials	Conforms to RoHS		
Dimensions	➔ Internet: mpa-s		
Weight	[g]	200	
Technical data on valves	➔ Internet: mpa-s		
Protection class to EN 60529	IP65 (when fully plugged in or fitted with protective cover)		

CPI installation system

Technical data – MPA-S valve terminals

FESTO

Operating and environmental conditions	
Operating medium	Compressed air to ISO 8573-1:2010 [7:4:4]
Note about operating/pilot medium	Lubricated operation possible (subsequently required for further operation)
Operating pressure [bar]	-0.9 ... +10
Ambient temperature [°C]	-5 ... +50
Medium temperature [°C]	-5 ... +50
Storage temperature [°C]	-20 ... +40
CE mark (see declaration of conformity)	To EU EMC Directive ¹⁾
	To EU Explosion Protection Directive (ATEX)
Certification	c UL us - Recognized (OL)

1) For information about the applicability of the component see the manufacturer's EC declaration of conformity at: www.festo.com/sp → User documentation.
If the component is subject to restrictions on usage in residential, office or commercial environments or small businesses, further measures to reduce the emitted interference may be necessary.

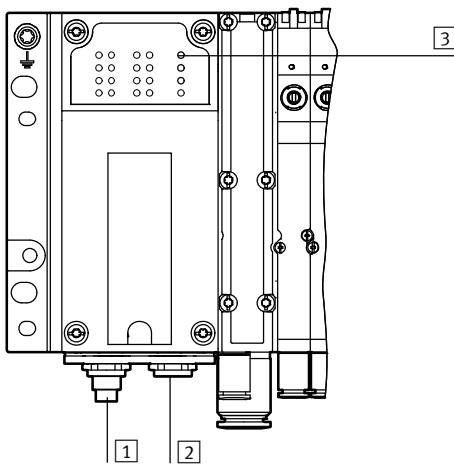

Certifications	
ATEX category gas	II 3G
Ex-ignition protection type gas	Ex nA IIC T4 X Gc
Explosion-proof temperature rating [°C]	-5 ≤ Ta ≤ +50

Connection and display components

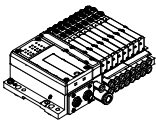

- 1 CP connection, incoming
- 2 CP connection, outgoing
- 3 Status LEDs
 - CP system supply (green)
 - Load supply (green)
 - Module fault (red)

Ordering data – Accessories

Designation	Part No.	Type		
MPA-S valve terminal				
 With CPI interface	546280	MPA-CPI-VI		
Valve terminal connection				
	Connecting cable WS-WD	0.25 m	540327	KVI-CP-3-WS-WD-0,25
		0.5 m	540328	KVI-CP-3-WS-WD-0,5
		2 m	540329	KVI-CP-3-WS-WD-2
		5 m	540330	KVI-CP-3-WS-WD-5
		8 m	540331	KVI-CP-3-WS-WD-8
	Connecting cable GS-GD	2 m	540332	KVI-CP-3-GS-GD-2
		5 m	540333	KVI-CP-3-GS-GD-5
		8 m	540334	KVI-CP-3-GS-GD-8

CPI installation system

Technical data – CPV-SC valve terminals

FESTO

-  - Flow rate
170 l/min

-  - Valve width
10 mm

-  - Voltage
24 V DC

CPI interface for communication between a CPV-SC valve terminal and a CPI master. It activates a CPV-SC valve terminal with up to 16 solenoid coils.



General technical data		
Type		CPVSC1-AE16-CPI
CP interface, incoming		Plug M9, 5-pin
CP interface, outgoing		Socket M9, 5-pin
Max. no. of solenoid coils		16
LED display (product-specific)		Status LED for CP communication
		Status LEDs for valves
Nominal operating voltage	[V DC]	24
Operating voltage range	[V DC]	20.4 ... 26.4
Power failure bridging	Logic side only	[ms] 10
Current consumption at nominal operating voltage	Load	[mA] Dependent on valve type and number of valves
	Electronics	[mA] Max. 100
Materials		Reinforced PA
Note on materials		RoHS-compliant
Dimensions (L x W x D)	[mm]	52 x 70 x 40
Weight	[g]	150
Technical data on valves		➔ Internet: cpv-sc

CPI installation system

Technical data – CPV-SC valve terminals

Operating conditions			
Protection class to EN 60529		IP20 (when fully plugged in or fitted with protective cover)	
Ambient temperature	Operation	[°C]	-5 ... +50
	Storage	[°C]	-20 ... +50
Corrosion resistance class CRC ¹⁾		1	
Certification		c UL us Recognized (OL)	

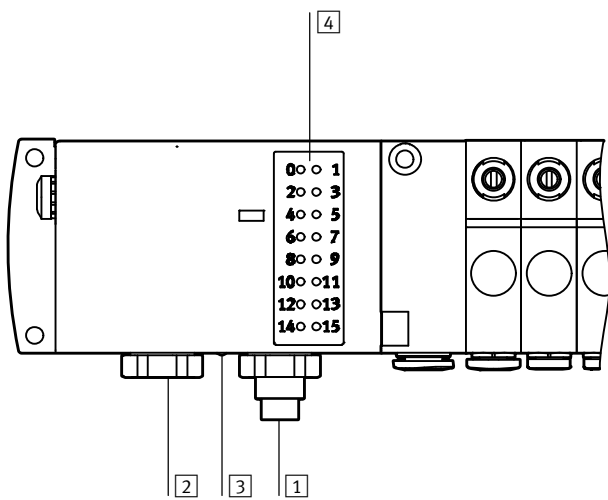

- 1) Corrosion resistance class 1 to Festo standard 940 070
 Components requiring low corrosion resistance. Transport and storage protection. Parts that do not have primarily decorative surface requirements, e.g. in internal areas that are not visible or behind covers.

Connection and display components

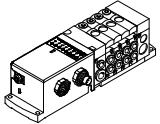

- 1 CP connection, incoming
- 2 CP connection, outgoing
- 3 Status LED for CP communication
- 4 Status LEDs for valves

Ordering data – Accessories

Designation	Part No.	Type		
CPV-SC valve terminals				
 with CPI interface	541975	CPVSC1-AE16-CPI		
Valve terminal connection				
	Connecting cable WS-WD	0.25 m	540327	KVI-CP-3-WS-WD-0,25
		0.5 m	540328	KVI-CP-3-WS-WD-0,5
		2 m	540329	KVI-CP-3-WS-WD-2
		5 m	540330	KVI-CP-3-WS-WD-5
		8 m	540331	KVI-CP-3-WS-WD-8
	Connecting cable GS-GD	2 m	540332	KVI-CP-3-GS-GD-2
		5 m	540333	KVI-CP-3-GS-GD-5
		8 m	540334	KVI-CP-3-GS-GD-8

CPI installation system

Technical data

FESTO

Dimensions – Sturdy input modules

Download CAD data → www.festo.com

CP-E16-M8

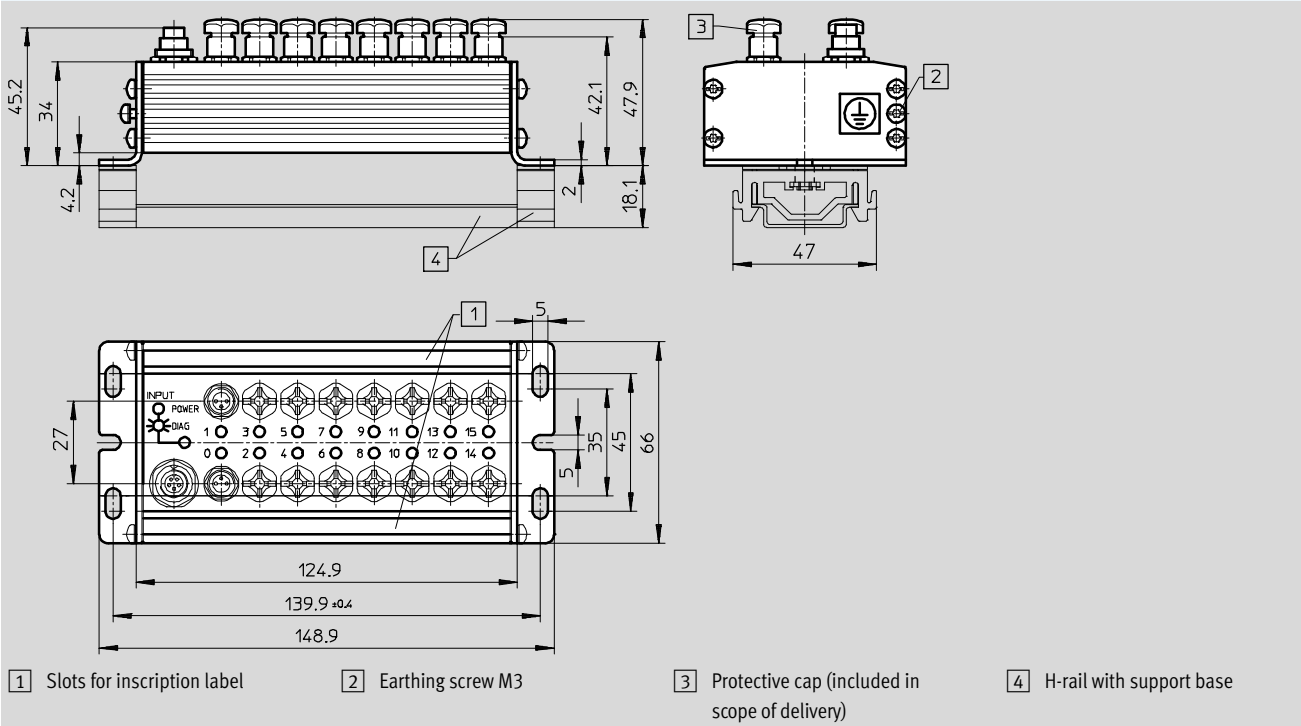

CP-E16-M8-Z

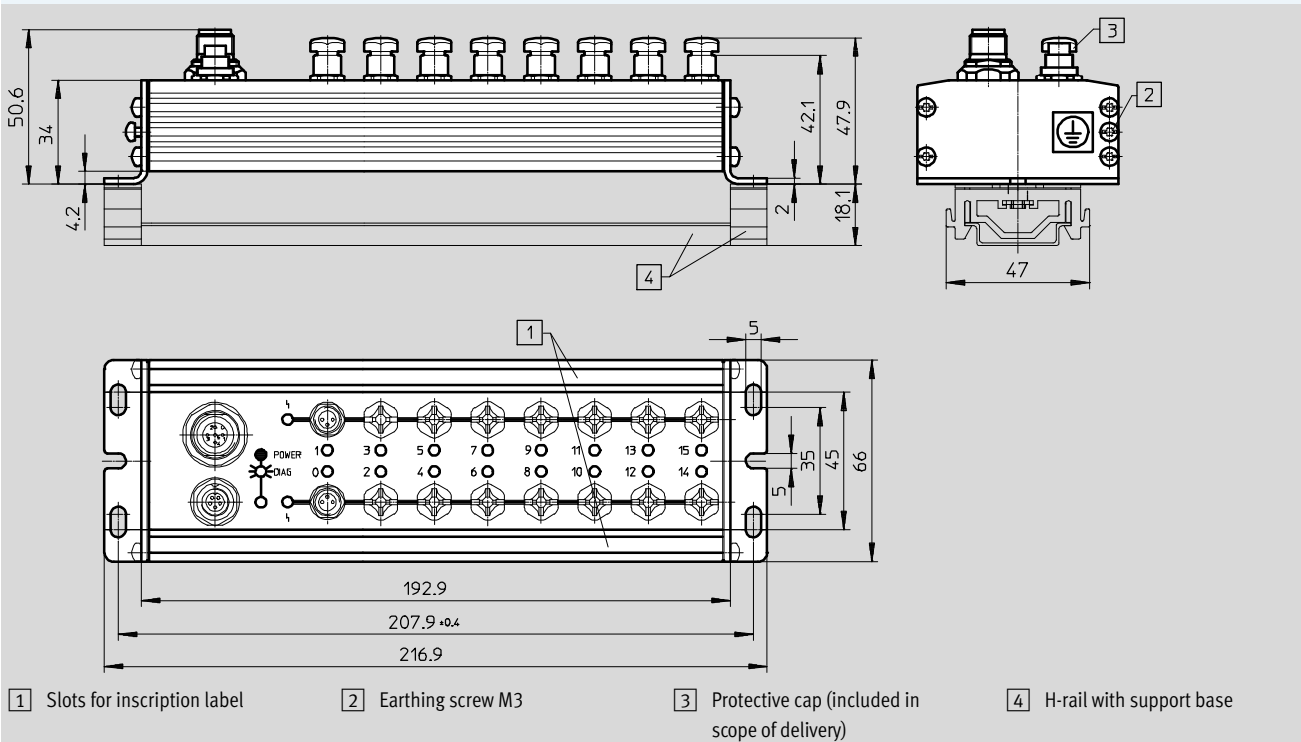

CPI installation system

Technical data

FESTO

Dimensions – Sturdy input modules

Download CAD data → www.festo.com

CP-E16-M12x2-5POL/CP-E16N-M12x2

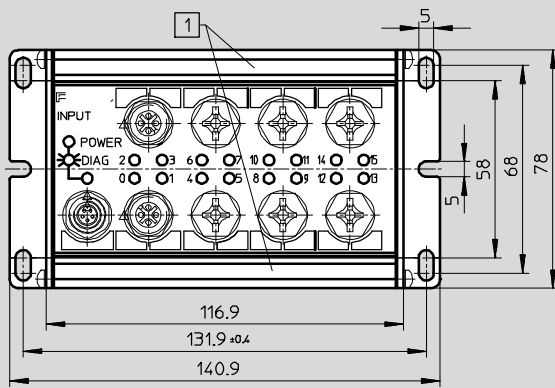
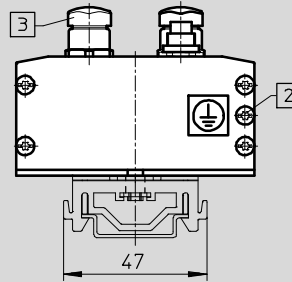
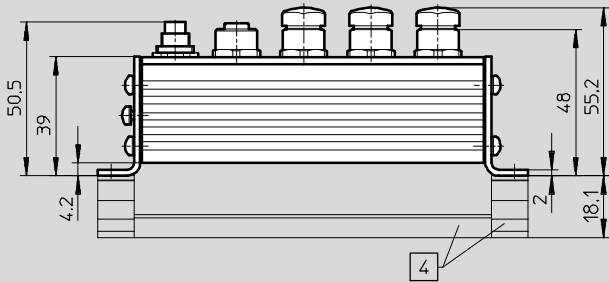

1 Slots for inscription label

2 Earthing screw M3

3 Protective cap (included in scope of delivery)

4 H-rail with support base

CPI installation system

Technical data

Dimensions – Economical input modules

Download CAD data → www.festo.com

CP-E16-M8-EL

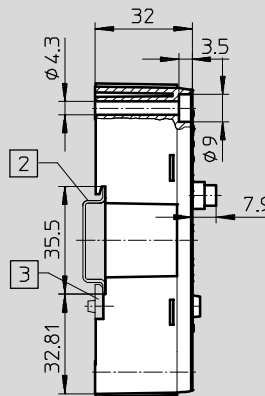
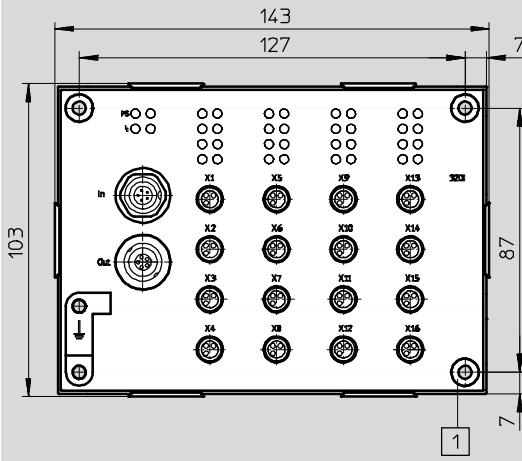

- 1 Through-hole for surface mounting
- 2 H-rail
- 3 Mounting kit for H-rail (included in the scope of delivery)

CP-E16-M12-EL

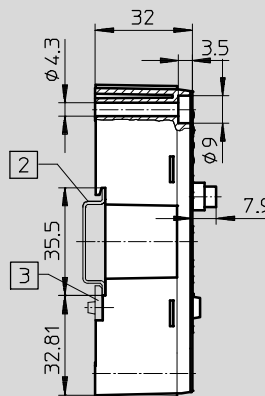
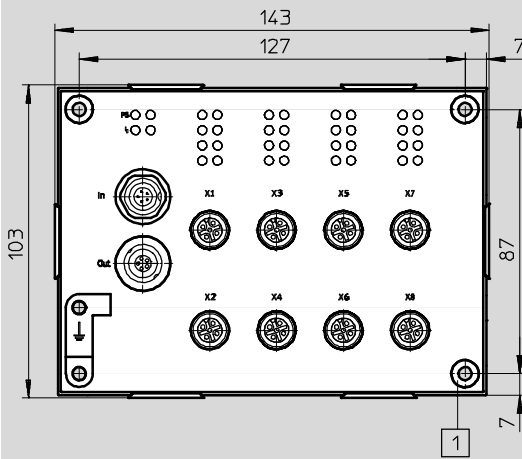

- 1 Through-hole for surface mounting
- 2 H-rail
- 3 Mounting kit for H-rail (included in the scope of delivery)

CP-E32-M8-EL

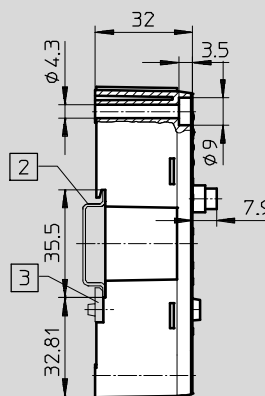
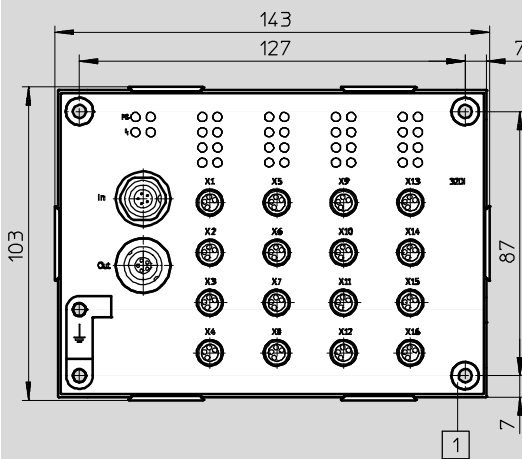

- 1 Through-hole for surface mounting
- 2 H-rail
- 3 Mounting kit for H-rail (included in the scope of delivery)

CPI installation system

Technical data

FESTO

Dimensions – Sturdy output modules

Download CAD data → www.festo.com

CP-A08-M12-5/CP-A08N-M12

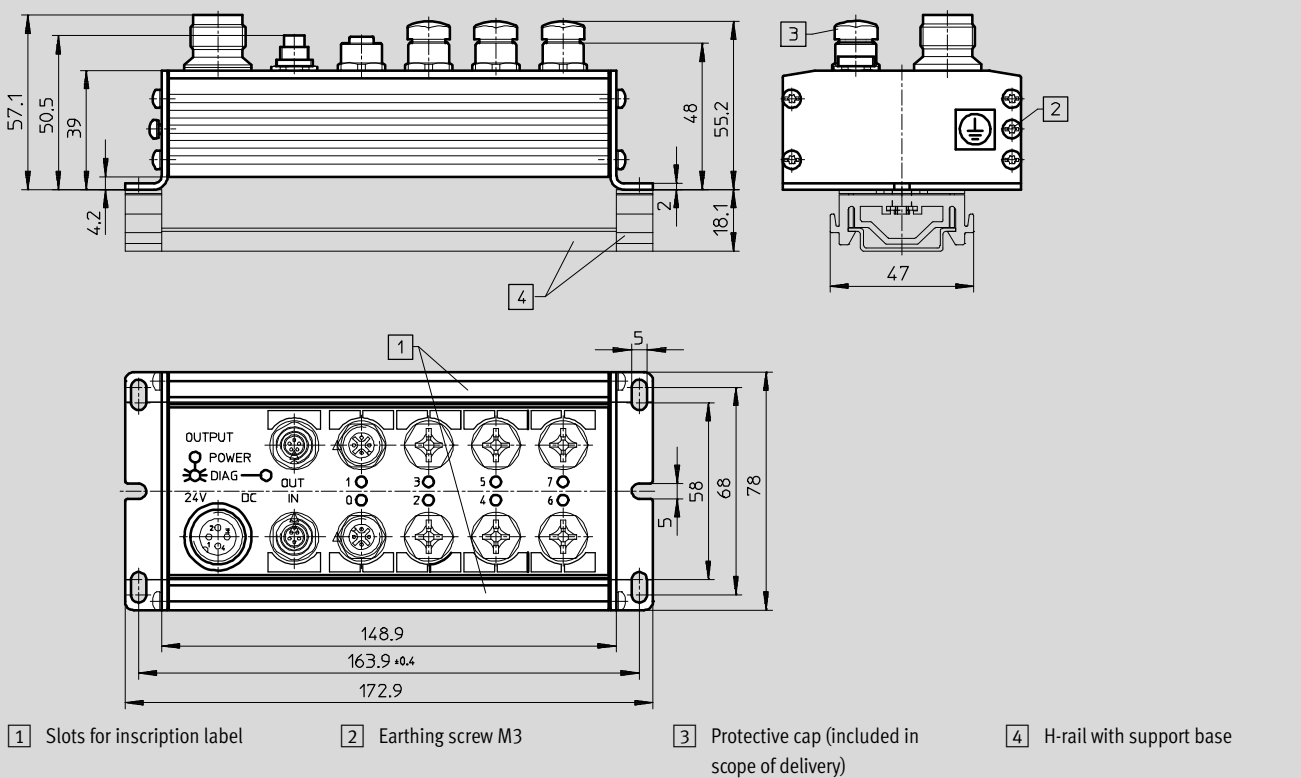

Dimensions – Economical output module

Download CAD data → www.festo.com

CP-A08-M12-EL-Z

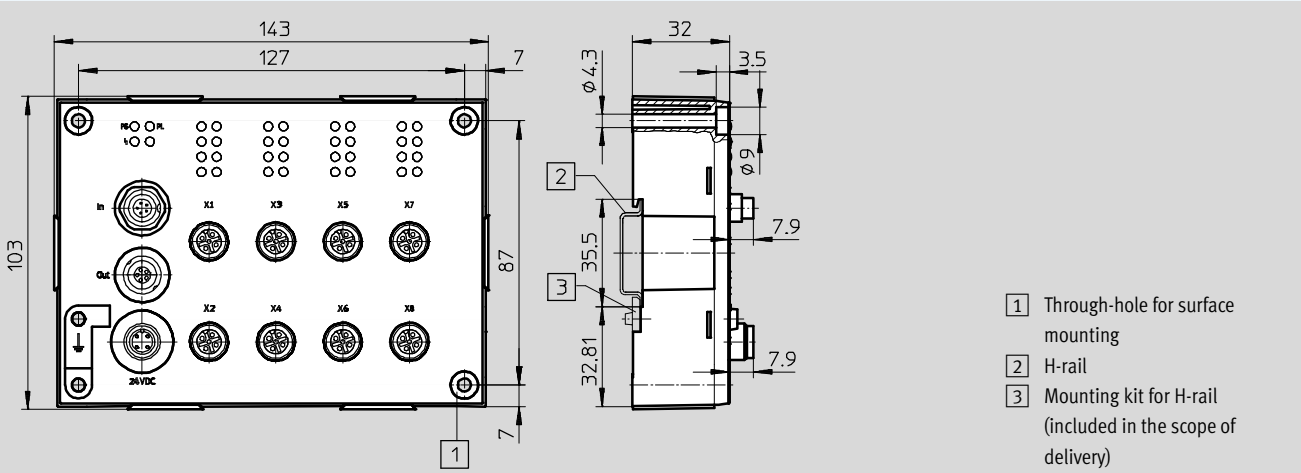

CPI installation system

Technical data

Dimensions – Compact CP modules

Download CAD data → www.festo.com

CP-E08-M12-CL/CP-A04-M12-CL

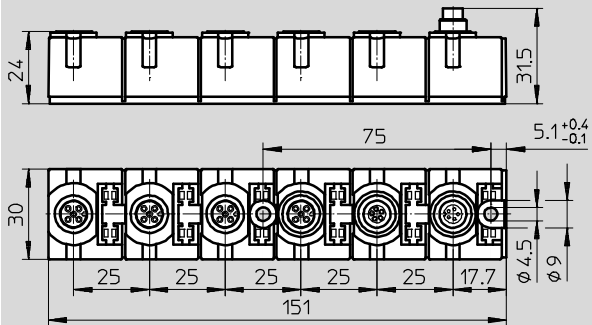

CP-E08-M8-CL

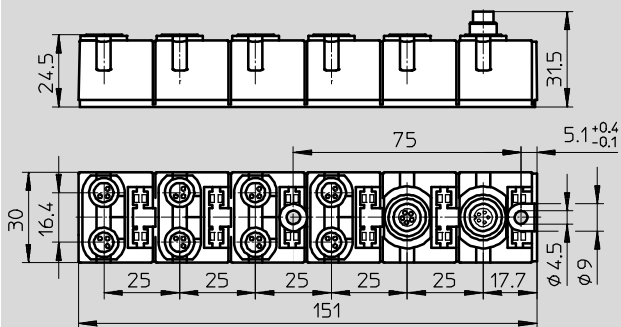

CP-E16-KL-CL

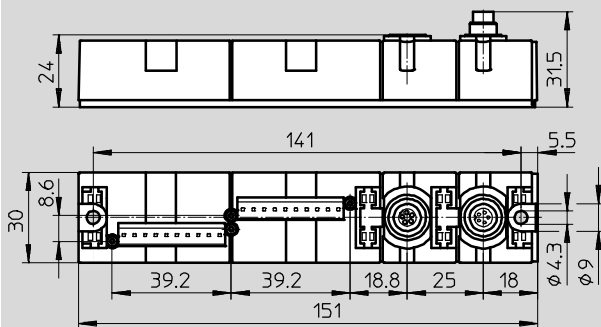

CPI installation system

Order processing information

Configuration guidelines

The CPI system supports a certain number of modules per CP string depending on the type of the CP

master and the CP modules connected.

CP masters and CP modules can be split into two different groups:

- With CPI functionality
- Without CPI functionality

CP modules with CPI functionality

CP modules with CPI functionality offer the following features:

- Incoming and outgoing CP interface
- Any arrangement of the modules within a CP string

- Max. 4 modules per CP string
- Max. 32 inputs and outputs can be connected to each string depending on the version

CP modules without CPI functionality

Sturdy CP modules offer the following features:

- CP valve terminals and CP output modules have an incoming and outgoing CP interface
- CP input modules only have an incoming CP interface and therefore

can only be positioned at the end of a CP string

- All CP modules with CPI functionality can also be connected to CP masters without extended functionality

Information on using CP modules with and without CPI functionality

A mixture of CP modules with and without CPI functionality is possible. The following must be noted in this regard:

- Only one input module without CPI functionality is possible per CP string (at the end of a CP string)

- Only one CP valve terminal or output module without CPI functionality is possible per CP string (any point in the CP string)

- Free positions in the CP string can be filled by CP modules with CPI functionality (max. 4 modules)

 **Note**

The cable length for any given string may not exceed 10 m.

Connecting cables are available in lengths of 0.25 m, 0.5 m, 2 m, 5 m and 8 m
→ 69

The maximum number of inputs and outputs that can be connected is 32 each (sum of all CP modules on a CP string), regardless of the type of CP module (with or without CPI functionality).

Order processing

There is one way of placing an order for the electrical CPI installation system:

- Digitally using the valve terminal configurator

Please note that the CP strings must be allocated in ascending numerical order, i.e. starting with string 1, followed by string 2, etc. without omitting any numbers.

To correctly allocate a CP string, proceed as follows:

- First select a connecting cable of appropriate length.
- Then select an input/output module.
- Continue in this way until the string is fully allocated (max. 4 strings for CP modules with extended functionality).

The valve terminals are configured separately:







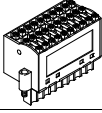

- CPV valve terminal
CPV10/14/18-VI-FB-....
→ Internet: cpv
- MPA-S valve terminals
MPA-S-CPI-VI
→ Internet: mpa-s

- CPV-SC valve terminals
CPVSC1-AE16-CPI
→ Internet: cpv-sc

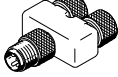
CPI installation system

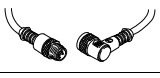
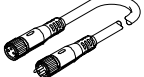
Accessories



FESTO

Ordering data				
Designation			Part No.	Type
Connection sets for power supply and sensors				
	Plug, screw-in tension-spring socket	3-row, 30-pin	197161	PS1-SAC30-30POL
	Plug, screw-in tension-spring socket with LED	3-row, 30-pin	197162	PS1-SAC31-30POL+LED
Sensor plugs				
	Plug M12, straight socket	5-pin, PG7	175487	SEA-M12-5GS-PG7
		4-pin, PG7	18666	SEA-GS-7
		4-pin, 2.5 mm ² O.D.	192008	SEA-4GS-7-2,5
	Plug M8, straight	3-pin, solderable	18696	SEA-GS-M8
		3-pin, screw-in	192009	SEA-3GS-M8-S
	Plug M12 for 2 sensor cables, PG11	4-pin	18779	SEA-GS-11-DUO
		5-pin	192010	SEA-5GS-11-DUO
	Push-in T-connector	2x socket M8, 3-pin 1x plug M8, 4-pin	544391	NEDU-M8D3-M8T4
		2x socket M12, 5-pin 1x plug M12, 4-pin	541596	NEDU-M12D5-M12T4
Connecting cables				
	DUO cable, 1x straight plug M8, 4-pin	2x straight socket M8	574591	NEDU-L2R1-M8G3-K-1L1-1L2-M8G4
		2x straight socket	18685	KM12-DUO-M8-GDGD
		2x straight/angled socket	18688	KM12-DUO-M8-GDWD
		2x angled socket	18687	KM12-DUO-M8-WDWD
	Connecting cable M8-M8, straight plug-straight socket	0.5 m	175488	KM8-M8-GSGD-0,5
		1.0 m	175489	KM8-M8-GSGD-1
		2.5 m	165610	KM8-M8-GSGD-2,5
		5.0 m	165611	KM8-M8-GSGD-5
	Extension cable M12-M12, 5-pin, straight plug-straight socket	1.5 m	529044	KV-M12-M12-1,5
		3.5 m	530901	KV-M12-M12-3,5
	Connecting cable M12-M12, 4-pin, straight plug-straight socket	2.5 m	18684	KM12-M12-GSGD-2,5
5.0 m		18686	KM12-M12-GSGD-5	
	Connecting cable M12-M12, 4-pin, straight plug-angled socket	1.0 m	185499	KM12-M12-GSWD-1-4
	Modular system for connecting cables		-	NEBU-... → Internet: nebu
Connecting cable – CP modules				
	Connecting cable WS-WD, angled plug-angled socket	0.25 m	540327	KVI-CP-3-WS-WD-0,25
		0.5 m	540328	KVI-CP-3-WS-WD-0,5
		2 m	540329	KVI-CP-3-WS-WD-2
		5 m	540330	KVI-CP-3-WS-WD-5
		8 m	540331	KVI-CP-3-WS-WD-8
	Connecting cable GS-GD, straight plug-straight socket	2 m	540332	KVI-CP-3-GS-GD-2
		5 m	540333	KVI-CP-3-GS-GD-5
		8 m	540334	KVI-CP-3-GS-GD-8
	Connector plug for CP cable (control cabinet implementation)		543252	KVI-CP-3-SSD

CPI installation system

Accessories

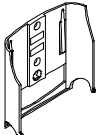
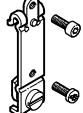
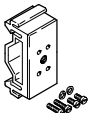
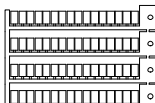
FESTO

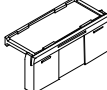
Ordering data				
Designation			Part No.	Type
Protective caps				
	Protective cap for sealing unused sockets (10 pieces)	for M8 connections	177672	ISK-M8
		for M12 connections	165592	ISK-M12
Mounting attachments				
	Retainer CPX-MMI		534705	CPX-MMI-1-H
	Mounting for H-rail, CPX-MMI		536689	CPX-MMI-1-NRH
	Mounting for H-rail, CP modules		170169	CP-TS-HS35
Inscription labels				
	Inscription labels 6x10 mm in frames (64 pieces)		18576	IBS-6x10
	Inscription labels 8x20 mm in frames (20 pieces) for compact modules (CP-...-CL)		539388	IBS-8x20
	Inscription label holders for EL modules, bag of 10		547473	ASCF-H-E2

CPI installation system

Accessories

FESTO

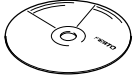
Ordering data – Documentation				
Designation			Part No.	Type
	User documentation for CPX CP interface	German	539293	P.BE-CPX-CP-DE
		English	539294	P.BE-CPX-CP-EN
		Spanish	539295	P.BE-CPX-CP-ES
		French	539296	P.BE-CPX-CP-FR
		Italian	539297	P.BE-CPX-CP-IT
	User documentation for sturdy input/output modules	German	165125	P.BE.-CPEA-DE
		English	165225	P.BE.-CPEA-EN
		French	165127	P.BE.-CPEA-FR
		Italian	165157	P.BE.-CPEA-IT
		Spanish	165227	P.BE.-CPEA-ES
	User documentation for compact input/output modules	German	539299	P.BE.-CPEA-CL-DE
		English	539300	P.BE.-CPEA-CL-EN
		French	539302	P.BE.-CPEA-CL-FR
		Italian	539303	P.BE.-CPEA-CL-IT
		Spanish	539301	P.BE.-CPEA-CL-ES
	System description	German	165126	P.BE-CPSYS-DE
		English	165226	P.BE-CPSYS-EN
		French	165128	P.BE-CPSYS-FR
		Italian	165158	P.BE-CPSYS-IT
Spanish		165228	P.BE-CPSYS-ES	
Software				
	Programming software	German	537927	FST4.1DE
		English	537928	FST4.1GB