

# Inscription label holders ASCF

Technical data

**Inscription label holder IBT, VMPA1, CPX, CPVSC1-ST, CPV**  
**Identification clip MN2H, MVH**

Inscription label holders enable inscription labels to be attached to components without pre-assembled carriers, or with special carriers for holders of this type.

If display components are concealed by the inscription label holder, the carrier is either semi-transparent or completely transparent.



 Note  
 Microsoft Word templates for inscription label holders/identification strips can be found at:  
 → [www.festo.com](http://www.festo.com)

Materials								
Type	MN2H	MVH	IBT	VMPA1-ST-1	VMPA1-ST-2	CPX	CPVSC1-ST	CPV
Inscription label holder	PA	PA	PC	PP	POM	PP	PVC	PVC

## Examples illustrating the attachment of inscription label holders

MVH-BZ (similar to MN2H-BZT-...)

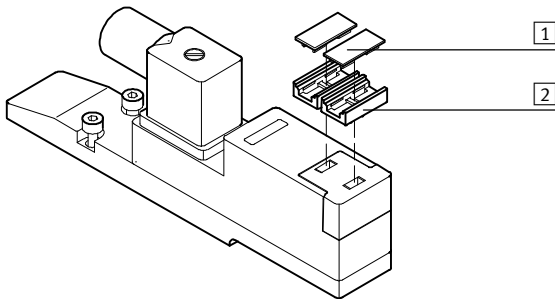

- 1 Inscription labels IBS-9x17
- 2 Inscription label holder MVH-BZ

- The inscription label holder is snapped into recesses on the valve
- The inscription is created using inscription labels

# Inscription label holders ASCF

Technical data

## Examples illustrating the attachment of inscription label holders

VMPA1-ST...

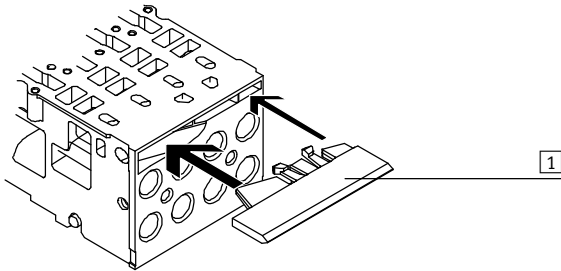

1 Inscription label holder VMPA1-ST...

- The inscription label holder is snapped into recesses on the valve terminal
- The inscription is created by inserting identification strips

CPVSC1-ST...

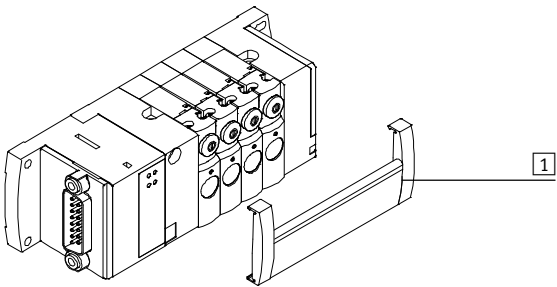

1 Inscription label holder CPVSC1-ST...

- The inscription label holder is clipped onto the valve terminal
- The inscription is created by inserting identification strips

CPV10-VI...

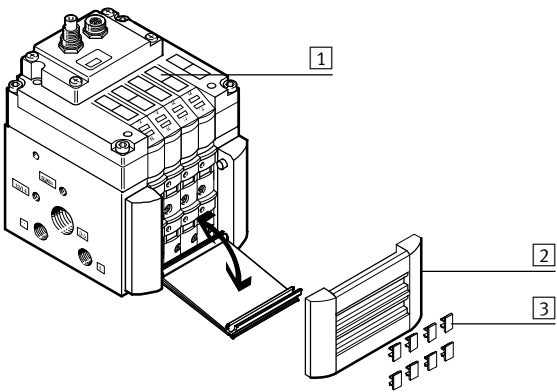

1 Inscription labels IBS-9x20  
2 Inscription label holder CPV10-VI-BZT...  
3 Inscription labels IBS-6x10

- The inscription label holder is snapped into recesses on the valve terminal
- The inscription is created using inscription labels or by inserting identification strips

Note

The inscription label holder cannot be used together with relay slices.

# Inscription label holders ASCF

Technical data

FESTO

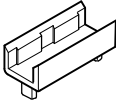
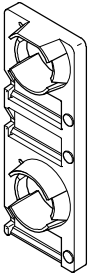
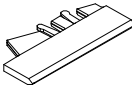
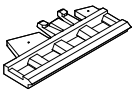
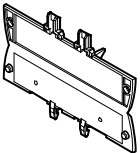
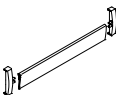
Ordering data						
	Carriers for inscription labels	Use	For modules with the following number of valves	Weight	Part No.	Type
				[g]		
	IBS-9x17 (1 piece)	Valve terminal type 14	–	7	<b>161936</b>	<b>MN2H-BZT-10X</b>
	IBS-9x17 (1 piece)	–	–	19	<b>18575</b>	<b>MVH-BZ</b>
	IBS-9x20 (3 pieces)	Valve terminal type 02	–	47	<b>158968</b>	<b>IBT-02-E/A</b>
	Insertable label or paper/ cardboard strips	Valve terminal type 32 MPA	–	6	<b>533362</b>	<b>VMPA1-ST-1-4</b>
	IBS-6x10 (4 pieces)	Valve terminal type 32 MPA	–	8	<b>544384</b>	<b>VMPA1-ST-2-4</b>
	Insertable label or paper/ cardboard strips	Modular electrical terminal CPX	–	5	<b>536593</b>	<b>CPX-ST-1</b>
	Insertable label or paper/ cardboard strips	Valve terminal type 80 CPV-SC	2	5	<b>547395</b>	<b>CPVSC1-ST-2</b>
			3	6	<b>547396</b>	<b>CPVSC1-ST-3</b>
			4	7	<b>527631</b>	<b>CPVSC1-ST-4</b>
			5	7	<b>547397</b>	<b>CPVSC1-ST-5</b>
			6	8	<b>547398</b>	<b>CPVSC1-ST-6</b>
			7	8	<b>547399</b>	<b>CPVSC1-ST-7</b>
			8	9	<b>527633</b>	<b>CPVSC1-ST-8</b>
			9	10	<b>547400</b>	<b>CPVSC1-ST-9</b>
			10	12	<b>547401</b>	<b>CPVSC1-ST-10</b>
			11	13	<b>547402</b>	<b>CPVSC1-ST-11</b>
			12	15	<b>527635</b>	<b>CPVSC1-ST-12</b>
			13	16	<b>547403</b>	<b>CPVSC1-ST-13</b>
			14	17	<b>547404</b>	<b>CPVSC1-ST-14</b>
			15	18	<b>547405</b>	<b>CPVSC1-ST-15</b>
			16	20	<b>527637</b>	<b>CPVSC1-ST-16</b>

# Inscription label holders ASCF

Technical data

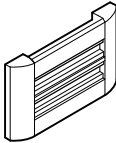
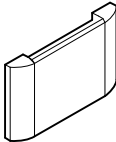
Ordering data						
	Carriers for inscription labels	Use	For modules with the following number of valves	Weight	Part No.	Type
				[g]		
	IBS-6x10 (4 pieces)	Valve terminal type 10	2	9	162560	CPV10-VI-BZ-T-2
	IBS-6x10 (6 pieces)	CPV in size 10	3	10	162561	CPV10-VI-BZ-T-3
	IBS-6x10 (8 pieces)		4	11	162562	CPV10-VI-BZ-T-4
	IBS-6x10 (10 pieces)		5	15	162563	CPV10-VI-BZ-T-5
	IBS-6x10 (12 pieces)		6	14	162564	CPV10-VI-BZ-T-6
	IBS-6x10 (14 pieces)		7	15	162565	CPV10-VI-BZ-T-7
	IBS-6x10 (16 pieces)		8	16	162566	CPV10-VI-BZ-T-8
	IBS-6x10 (4 pieces)	Valve terminal type 10	2	10	162567	CPV14-VI-BZ-T-2
	IBS-6x10 (6 pieces)	CPV in size 14	3	11	162568	CPV14-VI-BZ-T-3
	IBS-6x10 (8 pieces)		4	13	162569	CPV14-VI-BZ-T-4
	IBS-6x10 (10 pieces)		5	15	162570	CPV14-VI-BZ-T-5
	IBS-6x10 (12 pieces)		6	16	162571	CPV14-VI-BZ-T-6
	IBS-6x10 (14 pieces)		7	19	162572	CPV14-VI-BZ-T-7
	IBS-6x10 (16 pieces)		8	21	162573	CPV14-VI-BZ-T-8
	IBS-6x10 (4 pieces)	Valve terminal type 10	2	11	163293	CPV18-VI-BZ-T-2
	IBS-6x10 (6 pieces)	CPV in size 18	3	12	163294	CPV18-VI-BZ-T-3
	IBS-6x10 (8 pieces)		4	17	163295	CPV18-VI-BZ-T-4
	IBS-6x10 (10 pieces)		5	18	163296	CPV18-VI-BZ-T-5
	IBS-6x10 (12 pieces)		6	20	163297	CPV18-VI-BZ-T-6
	IBS-6x10 (14 pieces)		7	23	163298	CPV18-VI-BZ-T-7
IBS-6x10 (16 pieces)	8		29	163299	CPV18-VI-BZ-T-8	
	Insertable label or paper/ cardboard strips	Valve terminal type 10 CPV in size 10	2	8	194066	CPV10-VI-ST-2
			3	10	194067	CPV10-VI-ST-3
			4	11	194068	CPV10-VI-ST-4
			5	13	194069	CPV10-VI-ST-5
			6	14	194070	CPV10-VI-ST-6
			7	15	194071	CPV10-VI-ST-7
			8	16	194072	CPV10-VI-ST-8
			Valve terminal type 10 CPV in size 14	2	10	194073
		3		11	194074	CPV14-VI-ST-3
		4		14	194075	CPV14-VI-ST-4
		5		15	194076	CPV14-VI-ST-5
		6		20	194077	CPV14-VI-ST-6
		7		19	194078	CPV14-VI-ST-7
		8		22	194079	CPV14-VI-ST-8
		Valve terminal type 10 CPV in size 18		2	11	194080
			3	13	194081	CPV18-VI-ST-3
			4	15	194082	CPV18-VI-ST-4
			5	18	194083	CPV18-VI-ST-5
			6	21	194084	CPV18-VI-ST-6
			7	23	194085	CPV18-VI-ST-7
			8	28	194086	CPV18-VI-ST-8

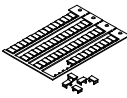
Ordering data – Accessories			
	Description	Part No.	Type
	Inscription labels 6x10 mm, 64 pieces, in frames	18576	IBS-6x10
	Inscription labels 9x17 mm, 24 pieces, in frames	161937	IBS-9x17
	Inscription labels 9x20 mm, 20 pieces, in frames	18182	IBS-9x20