

## Axiální sady EAMM-A

**FESTO**



# Axiální sady EAMM-A

typové značení

FESTO

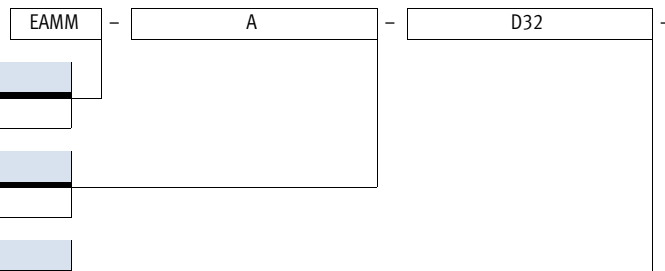

typ	
EAMM	sada

umístění motoru	
A	axiální

rozhraní pro mechaniku pohonů	
D19	EGSL-35
D32	DNCE-32; EGSL-45
D32-35A	ERMB-20, EHMB-20
D40	DNCE-40; EGSL-55, ERMB-25, EHMB-25
D60	DNCE-63; EGSL-75, ERMB-32, EHMB-32, ESBF-63
D80	ESBF-80
D100	ESBF-100
E20	DGE-18-...-SP, DMES-18
E32	DGE-25-...-SP, DMES-25
E48	DGE-40-...-SP, DMES-40
E72	DGE-63-...-SP, DMES-63
F28	DGEA-18
F30	DGE-25-...-ZR
F32	DGEA-25
F37	DGE-25-...-ZR-RF
F40	DGE-40-...-ZR, DGEA-40
F47	DGE-40-...-ZR-RF
F62	DGE-63-...-ZR
F80	DGE-63-...-ZR-RF
G13	DGE-8-...-ZR
G16	DGE-12-...-ZR
G19	DGE-18-...-ZR
L27	EGC-50-...-TB
L38	EGC-70-...-TB
L48	EGC-80-...-TB
L62	EGC-120-...-TB
L95	EGC-185-...-TB
M43	EGC-HD-125-...-TB
M48	EGC-HD-160-...-TB
M80	EGC-HD-220-...-TB
N38	ELGA-TB-...-70
N48	ELGA-TB-...-80
N80	ELGA-TB-...-120
P3-28D	EGSK-15
P4-28B	EGSK-20/EGSP-20
P5-28B	EGSK-26/EGSP-26
P6-38A	EGSK-33
P8-38A	EGSK-46, EGSP-33
P10-38A	EGSP-46
R27	ELGG-...-35, ELGR-...-35
R38	ELGG-...-45, ELGR-...-45
R48	ELGG-...-55, ELGR-...-55
S38	EGC-70-...-BS, EGC-HD-125-...-BS
S48	EGC-80-...-BS, EGC-HD-160-...-BS
S62	EGC-120-...-BS, EGC-HD-220-...-BS
S95	EGC-185-...-BS

# Axiální sady EAMM-A

typové značení

FESTO

		60P	-	
<b>rozhraní pro motor</b>				
40P	servomotor EMME-AS-40			
60P	servomotor EMME-AS-60			
80P	servomotor EMME-AS-80			
40A	servomotor EMMS-AS-40			
55A	servomotor EMMS-AS-55			
70A	servomotor EMMS-AS-70			
100A	servomotor EMME-AS-100, EMMS-AS-100			
140A	servomotor EMMS-AS-140			
190A	servomotor EMMS-AS-190			
28A	krokový motor EMMS-ST-28			
42A	krokový motor EMMS-ST-42			
57A	krokový motor EMMS-ST-57			
87A	krokový motor EMMS-ST-87			
32B	jednotka motoru MTR-DCI-32-...-G7/G14			
42B	jednotka motoru MTR-DCI-42-...-G7			
42C	jednotka motoru MTR-DCI-42-...-G14			
52B	jednotka motoru MTR-DCI-52-...-G7			
52C	jednotka motoru MTR-DCI-52-...-G14			
62B	jednotka motoru MTR-DCI-62-...-G7/G14/G22			
40G	převodovka EMGA-40			
60G	převodovka EMGA-60-...-SAS/SST			
60H	převodovka EMGA-60-...-EAS			
80G	převodovka EMGA-80			
120G	převodovka EMGA-120			
160G	převodovka EMGA-160			
<b>zvláštní provedení</b>				
S1	stupeň krytí IP65			

# Axiální sady EAMM-A

přehled dodávek

FESTO

Přípustné kombinace pohonů a motorů pro pohony s ozubeným řemenem DGE-ZR

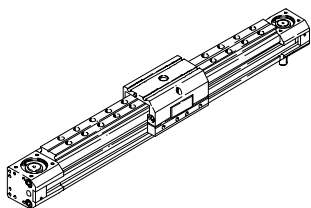

motor/převodovka	axiální sada	
typ	č. dílu	typ
<b>DGE-8-...-ZR</b>		
se servomotorem		
EMMS-AS-40-...	550921	EAMM-A-G13-40A
s krokovým motorem		
EMMS-ST-42-...	550922	EAMM-A-G13-42A
<b>DGE-12-...-ZR</b>		
se servomotorem		
EMMS-AS-40-...	550923	EAMM-A-G16-40A
EMMS-AS-55-...	550925	EAMM-A-G16-55A
s krokovým motorem		
EMMS-ST-42-...	550924	EAMM-A-G16-42A
<b>DGE-18-...-ZR</b>		
se servomotorem		
EMMS-AS-40-...	550926	EAMM-A-G19-40A
EMMS-AS-55-...	550927	EAMM-A-G19-55A
s krokovým motorem		
EMMS-ST-57-...	550928	EAMM-A-G19-57A
<b>DGE-25-...-ZR</b>		
se servomotorem		
EMMS-AS-55-...	550929	EAMM-A-F30-55A
EMMS-AS-70-...	550932	EAMM-A-F30-70A
se servomotorem a převodovkou		
EMMS-AS-55-...	550931	EAMM-A-F30-60G
EMGA-60-P-G...-SAS-55		
s krokovým motorem		
EMMS-ST-57-...	550930	EAMM-A-F30-57A
EMMS-ST-87-...	550933	EAMM-A-F30-87A
s krokovým motorem a převodovkou		
EMMS-ST-57-...	550931	EAMM-A-F30-60G
EMGA-60-P-G...-SST-57		
<b>DGE-25-...-ZR-RF</b>		
se servomotorem		
EMMS-AS-55-...	550942	EAMM-A-F37-55A
EMMS-AS-70-...	550945	EAMM-A-F37-70A
se servomotorem a převodovkou		
EMMS-AS-55-...	550944	EAMM-A-F37-60G
EMGA-60-P-G...-SAS-55		
s krokovým motorem		
EMMS-ST-57-...	550943	EAMM-A-F37-57A
EMMS-ST-87-...	550946	EAMM-A-F37-87A
s krokovým motorem a převodovkou		
EMMS-ST-57-...	550944	EAMM-A-F37-60G
EMGA-60-P-G...-SST-57		

motor/převodovka	axiální sada	
typ	č. dílu	typ
<b>DGE-40-...-ZR</b>		
se servomotorem		
EMMS-AS-70-...	550934	EAMM-A-F40-70A
EMME-AS-100-...	550937	EAMM-A-F40-100A
EMMS-AS-100-...	550937	EAMM-A-F40-100A
se servomotorem a převodovkou		
EMMS-AS-70-...	550935	EAMM-A-F40-80G
EMGA-80-P-G...-SAS-70		
EMME-AS-80-...	550935	EAMM-A-F40-80G
EMGA-80-P-G...-EAS-80		
EMME-AS-100-...	550935	EAMM-A-F40-80G
EMGA-80-P-G...-SAS-100		
EMMS-AS-100-...	550935	EAMM-A-F40-80G
EMGA-80-P-G...-SAS-100		
s krokovým motorem		
EMMS-ST-87-...	550936	EAMM-A-F40-87A
s krokovým motorem a převodovkou		
EMMS-ST-87-...	550935	EAMM-A-F40-80G
EMGA-80-P-G...-SST-87		
<b>DGE-40-...-ZR-RF</b>		
se servomotorem		
EMME-AS-100-...	550949	EAMM-A-F47-100A
EMMS-AS-100-...	550949	EAMM-A-F47-100A
EMMS-AS-140-...	550950	EAMM-A-F47-140A
se servomotorem a převodovkou		
EMME-AS-80-...	550947	EAMM-A-F47-80G
EMGA-80-P-G...-EAS-80		
EMME-AS-100-...	550947	EAMM-A-F47-80G
EMGA-80-P-G...-SAS-100		
EMMS-AS-100-...	550947	EAMM-A-F47-80G
EMGA-80-P-G...-SAS-100		
s krokovým motorem		
EMMS-ST-87-...	550948	EAMM-A-F47-87A
s krokovým motorem a převodovkou		
EMMS-ST-87-...	550947	EAMM-A-F47-80G
EMGA-80-P-G...-SST-87		

# Axiální sady EAMM-A

přehled dodávek

FESTO

Přípustné kombinace pohonů a motorů pro pohony s ozubeným řemenem DGE-ZR

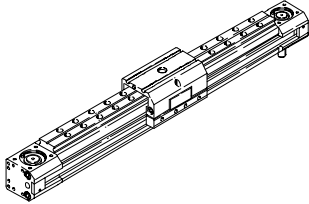

motor/převodovka typ	axiální sada	
	č. dílu	typ
<b>DGE-63-...-ZR</b>		
se servomotorem		
EMME-AS-100-...	550939	EAMM-A-F62-100A
EMMS-AS-100-...	550939	EAMM-A-F62-100A
EMMS-AS-140-...	550941	EAMM-A-F62-140A
se servomotorem a převodovkou		
EMME-AS-80-... EMGA-80-P-G...-EAS-80	550938	EAMM-A-F62-80G
EMME-AS-100-... EMGA-80-P-G...-SAS-100	550938	EAMM-A-F62-80G
EMMS-AS-100-... EMGA-80-P-G...-SAS-100	550938	EAMM-A-F62-80G
EMME-AS-100-... EMGA-120-P-G...-SAS-100	550940	EAMM-A-F62-120G
EMMS-AS-100-... EMGA-120-P-G...-SAS-100	550940	EAMM-A-F62-120G
EMMS-AS-140-... EMGA-120-P-G...-SAS-140	550940	EAMM-A-F62-120G
s krokovým motorem a převodovkou		
EMMS-ST-87-... EMGA-80-P-G...-SST-87	550938	EAMM-A-F62-80G

motor/převodovka typ	axiální sada	
	č. dílu	typ
<b>DGE-63-...-ZR-RF</b>		
se servomotorem		
EMME-AS-100-...	550952	EAMM-A-F80-100A
EMMS-AS-100-...	550952	EAMM-A-F80-100A
EMMS-AS-140-...	550954	EAMM-A-F80-140A
se servomotorem a převodovkou		
EMME-AS-80-... EMGA-80-P-G...-EAS-80	550951	EAMM-A-F80-80G
EMME-AS-100-... EMGA-80-P-G...-SAS-100	550951	EAMM-A-F80-80G
EMMS-AS-100-... EMGA-80-P-G...-SAS-100	550951	EAMM-A-F80-80G
EMME-AS-100-... EMGA-120-P-G...-SAS-100	550951	EAMM-A-F80-120G
EMMS-AS-100-... EMGA-120-P-G...-SAS-100	550951	EAMM-A-F80-120G
EMMS-AS-140-... EMGA-120-P-G...-SAS-140	550953	EAMM-A-F80-120G
EMMS-AS-140-... EMGA-160-P-G...-SAS-140	550955	EAMM-A-F80-160G
s krokovým motorem a převodovkou		
EMMS-ST-87-... EMGA-80-P-G...-SST-87	550951	EAMM-A-F80-80G

# Axiální sady EAMM-A

přehled dodávek

FESTO

Přípustné kombinace pohonů a motorů pro pohony s vřetenem DGE-SP

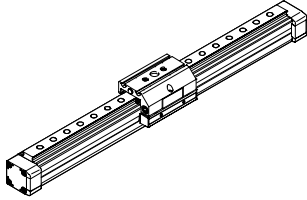

motor/převodovka	axiální sada	
typ	č. dílu	typ
<b>DGE-18</b>		
se servomotorem		
EMMS-AS-40-...	550961	EAMM-A-E20-40A
EMMS-AS-55-...	550963	EAMM-A-E20-55A
s krokovým motorem		
EMMS-ST-42-...	550962	EAMM-A-E20-42A
<b>DGE-25</b>		
se servomotorem		
EMMS-AS-40-...	550964	EAMM-A-E32-40A
EMMS-AS-55-...	550965	EAMM-A-E32-55A
s krokovým motorem		
EMMS-ST-57-...	550966	EAMM-A-E32-57A
<b>DGE-40</b>		
se servomotorem		
EMMS-AS-55-...	550969	EAMM-A-E48-55A
EMMS-AS-70-...	550971	EAMM-A-E48-44A-70A
EMME-AS-100-...	550973	EAMM-A-E48-100A
EMMS-AS-100-...	550973	EAMM-A-E48-100A
se servomotorem a převodovkou		
EMME-AS-40-...	550968	EAMM-A-E48-40G
EMGA-40-P-G...-EAS-40		
EMMS-AS-40-...	550968	EAMM-A-E48-40G
EMGA-40-P-G...-SAS-40		
s krokovým motorem		
EMMS-ST-57-...	550970	EAMM-A-E48-57A
EMMS-ST-87-...	550972	EAMM-A-E48-87A

motor/převodovka	axiální sada	
typ	č. dílu	typ
<b>DGE-63</b>		
se servomotorem		
EMMS-AS-70-...	550975	EAMM-A-E72-70A
EMME-AS-100-...	550978	EAMM-A-E72-100A
EMMS-AS-100-...	550978	EAMM-A-E72-100A
se servomotorem a převodovkou		
EMMS-AS-70-...	550974	EAMM-A-E72-60G
EMGA-60-P-G...-SAS-70		
EMMS-AS-70-...	550976	EAMM-A-E72-80G
EMGA-80-P-G...-SAS-70		
EMME-AS-80-...	550976	EAMM-A-E72-80G
EMGA-80-P-G...-EAS-80		
EMME-AS-100-...	550976	EAMM-A-E72-80G
EMGA-80-P-G...-SAS-100		
EMMS-AS-100-...	550976	EAMM-A-E72-80G
EMGA-80-P-G...-SAS-100		
s krokovým motorem		
EMMS-ST-87-...	550977	EAMM-A-E72-87A
s krokovým motorem a převodovkou		
EMMS-ST-87-...	550976	EAMM-A-E72-80G
EMGA-80-P-G...-SST-87		

# Axiální sady EAMM-A

přehled dodávek

FESTO

Přípustné kombinace pohonů a motorů pro polohovací pohony DMES

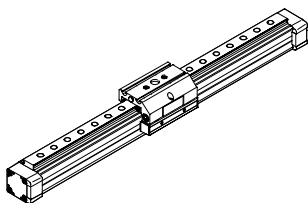

motor/převodovka	axiální sada	
typ	č. dílu	typ
<b>DMES-18</b>		
se servomotorem		
EMMS-AS-40-...	550961	EAMM-A-E20-40A
EMMS-AS-55-...	550963	EAMM-A-E20-55A
s krokovým motorem		
EMMS-ST-42-...	550962	EAMM-A-E20-42A
s jednotkou motoru		
MTR-DCI-32S-...	556991	EAMM-A-E20-32B
<b>DMES-25</b>		
se servomotorem		
EMMS-AS-40-...	550964	EAMM-A-E32-40A
EMMS-AS-55-...	550965	EAMM-A-E32-55A
s krokovým motorem		
EMMS-ST-57-...	550966	EAMM-A-E32-57A
s jednotkou motoru		
MTR-DCI-42S-...G7	556992	EAMM-A-E32-42B
MTR-DCI-42S-...G14	556993	EAMM-A-E32-42C
<b>DMES-40</b>		
se servomotorem		
EMMS-AS-55A-...	550969	EAMM-A-E48-55A
EMMS-AS-70-...	557448	EAMM-A-E48-64A-70A
EMME-AS-100-...	550973	EAMM-A-E48-100A
EMMS-AS-100-...	550973	EAMM-A-E48-100A
se servomotorem a převodovkou		
EMME-AS-40-...	550968	EAMM-A-E48-40G
EMGA-40-P-G...-EAS-40		
EMMS-AS-40-...	550968	EAMM-A-E48-40G
EMGA-40-P-G...-SAS-40		
s krokovým motorem		
EMMS-ST-57A-...	550970	EAMM-A-E48-57A
EMMS-ST-87-...	550972	EAMM-A-E48-87A
s jednotkou motoru		
MTR-DCI-52S-...-G7	556994	EAMM-A-E48-52B
MTR-DCI-52S-...-G14	556995	EAMM-A-E48-52C

motor/převodovka	axiální sada	
typ	č. dílu	typ
<b>DMES-63</b>		
se servomotorem		
EMMS-AS-70-...	550975	EAMM-A-E72-70A
EMME-AS-100-...	550978	EAMM-A-E72-100A
EMMS-AS-100-...	550978	EAMM-A-E72-100A
se servomotorem a převodovkou		
EMMS-AS-70-...	550974	EAMM-A-E72-60G
EMGA-60-P-G...-SAS-70		
EMMS-AS-70-...	550976	EAMM-A-E72-80G
EMGA-80-P-G...-SAS-70		
EMME-AS-80-...	550976	EAMM-A-E72-80G
EMGA-80-P-G...-EAS-80		
EMME-AS-100-...	550976	EAMM-A-E72-80G
EMGA-80-P-G...-SAS-100		
EMMS-AS-100-...	550976	EAMM-A-E72-80G
EMGA-80-P-G...-SAS-100		
s krokovým motorem		
EMMS-ST-87-...	550977	EAMM-A-E72-87A
s krokovým motorem a převodovkou		
EMMS-ST-87-...	550976	EAMM-A-E72-80G
EMGA-80-P-G...-SST-87		
s jednotkou motoru		
MTR-DCI-62S-...	556996	EAMM-A-E72-62B

# Axiální sady EAMM-A

přehled dodávek

FESTO

## Přípustné kombinace pohonů a motorů pro elektrické válce DNCE

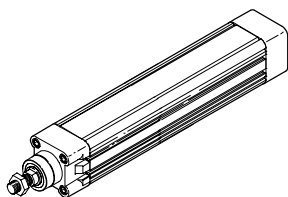

motor/převodovka	axiální sada	
typ	č. dílu	typ
<b>DNCE-32</b>		
se servomotorem		
EMME-AS-40-...	1976465	EAMM-A-D32-40P
	2207372	EAMM-A-D32-40P-S1 <sup>1)</sup>
EMMS-AS-40-...	543147	EAMM-A-D32-40A
	1322178	EAMM-A-D32-40A-S1 <sup>1)</sup>
EMMS-AS-55-...	550979	EAMM-A-D32-55A
	1322180	EAMM-A-D32-55A-S1 <sup>1)</sup>
EMME-AS-60-...	1956054	EAMM-A-D32-60P
	2234020	EAMM-A-D32-60P-S1 <sup>1)</sup>
s krokovým motorem		
EMMS-ST-42-...	543148	EAMM-A-D32-42A
	1322179	EAMM-A-D32-42A-S1 <sup>1)</sup>
EMMS-ST-57-...	550980	EAMM-A-D32-57A
	1322181	EAMM-A-D32-57A-S1 <sup>1)</sup>
s jednotkou motoru		
MTR-DCI-32S-... <sup>2)</sup>	543149	EAMM-A-D32-32B
<b>DNCE-40</b>		
se servomotorem		
EMMS-AS-55-...	543153	EAMM-A-D40-55A
	1322182	EAMM-A-D40-55A-S1 <sup>1)</sup>
EMME-AS-60-...	1977000	EAMM-A-D40-60P
	2151519	EAMM-A-D40-60P-S1 <sup>1)</sup>
EMMS-AS-70-...	550981	EAMM-A-D40-70A
	1322185	EAMM-A-D40-70A-S1 <sup>1)</sup>
se servomotorem a převodovkou		
EMME-AS-40-...	560282	EAMM-A-D40-40G
EMGA-40-P-G...-EAS-40		
EMMS-AS-40-...	560282	EAMM-A-D40-40G
EMGA-40-P-G...-SAS-40		
s krokovým motorem		
EMMS-ST-57-...	543154	EAMM-A-D40-57A
	1322183	EAMM-A-D40-57A-S1 <sup>1)</sup>
EMMS-ST-87-...	550982	EAMM-A-D40-87A
	1322186	EAMM-A-D40-87A-S1 <sup>1)</sup>
s krokovým motorem a převodovkou		
EMMS-ST-42-...	560282	EAMM-A-D40-40G
EMGA-40-P-G...-SST-42		
s jednotkou motoru		
MTR-DCI-42S-...-G7 <sup>2)</sup>	543155	EAMM-A-D40-42B
MTR-DCI-42S-...-G14 <sup>2)</sup>	543156	EAMM-A-D40-42C

motor/převodovka	axiální sada	
typ	č. dílu	typ
<b>DNCE-63</b>		
se servomotorem		
EMMS-AS-70-...	543161	EAMM-A-D60-70A
	1322187	EAMM-A-D60A-70A-S1 <sup>1)</sup>
EMME-AS-80-...	1977073	EAMM-A-D60-80P
	2218564	EAMM-A-D60-80P-S1 <sup>1)</sup>
EMME-AS-100-...	550983	EAMM-A-D60-100A
	1322190	EAMM-A-D60A-100A-S1 <sup>1)</sup>
EMMS-AS-100-...	550983	EAMM-A-D60-100A
	1322190	EAMM-A-D60A-100A-S1 <sup>1)</sup>
se servomotorem a převodovkou		
EMMS-AS-55-...	560283	EAMM-A-D60-60G
EMGA-60-P-G...-SAS-55		
EMMS-AS-70-...	560283	EAMM-A-D60-60G
EMGA-60-P-G...-SAS-70		
s krokovým motorem		
EMMS-ST-87-...	543162	EAMM-A-D60-87A
	1322188	EAMM-A-D60-87A-S1 <sup>1)</sup>
s krokovým motorem a převodovkou		
EMMS-ST-57-...	560283	EAMM-A-D60-60G
EMGA-60-P-G...-SST-57		
s jednotkou motoru		
MTR-DCI-52S-...-G7 <sup>2)</sup>	543163	EAMM-A-D60-52B
MTR-DCI-52S-...-G14 <sup>2)</sup>	543164	EAMM-A-D60-52C

1) se stupněm krytí IP65

2) pouze v kombinaci s DNCE-...-LS



### upozornění

Při použití sady těsnění EADS-F lze axiální sadu (bez „S1“ v typovém

kódu) dodatečně vybavit a zlepšit krytí z IP40 na IP65. → 50



# Axiální sady EAMM-A

přehled dodávek

FESTO

## Přípustné kombinace pohonů a motorů pro elektrické válce ESBF

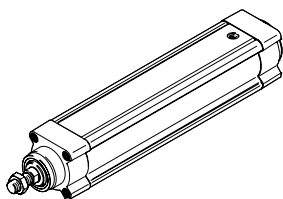

motor/převodovka	axiální sada	
typ	č. dílu	typ
<b>ESBF-63</b>		
se servomotorem		
EMMS-AS-70-...	543161	EAMM-A-D60-70A
	1679566	EAMM-A-D60B-70A-S1 <sup>1)</sup>
EMME-AS-80-...	1977073	EAMM-A-D60-80P
	2218564	EAMM-A-D60-80P-S1 <sup>1)</sup>
EMME-AS-100-...	550983	EAMM-A-D60-100A
	1679518	EAMM-A-D60B-100A-S1 <sup>1)</sup>
EMMS-AS-100-...	550983	EAMM-A-D60-100A
	1679518	EAMM-A-D60-100A-S1 <sup>1)</sup>
se servomotorem a převodovkou		
EMMS-AS-55-...	560283	EAMM-A-D60-60G
EMGA-60-P-G...-SAS-55		
EMMS-AS-70-...	560283	EAMM-A-D60-60G
EMGA-60-P-G...-SAS-70		
s krokovým motorem		
EMMS-ST-87-...	543162	EAMM-A-D60-87A
	1322188	EAMM-A-D60-87A-S1 <sup>1)</sup>
s krokovým motorem a převodovkou		
EMMS-ST-57-...	560283	EAMM-A-D60-60G
EMGA-60-P-G...-SST-57		

motor/převodovka	axiální sada	
typ	č. dílu	typ
<b>ESBF-80</b>		
se servomotorem		
EMME-AS-100-...	1589665	EAMM-A-D80-100A
	1600673	EAMM-A-D80-100A-S1 <sup>1)</sup>
EMMS-AS-100-...	1589665	EAMM-A-D80-100A
	1600673	EAMM-A-D80-100A-S1 <sup>1)</sup>
EMMS-AS-140-...	1588299	EAMM-A-D80-140A
	1600674	EAMM-A-D80-140A-S1 <sup>1)</sup>
<b>ESBF-100</b>		
se servomotorem		
EMMS-AS-140-...	1588349	EAMM-A-D100-140A
	1600675	EAMM-A-D100-140A-S1 <sup>1)</sup>

1) se stupněm krytí IP65



### upozornění

Při použití sady těsnění EADS-F lze axiální sadu (bez „S1“ v typovém

kódu) dodatečně vybavit a zlepšit krytí z IP40 na IP65. → 50

# Axiální sady EAMM-A

přehled dodávek

FESTO

Přípustné kombinace pohonů a motorů pro pohony s ozubeným řemenem EGC-TB

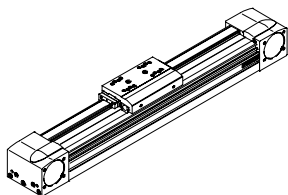

motor/převodovka	axiální sada	
typ	č. dílu	typ
<b>EGC-50</b>		
se servomotorem		
EMMS-AS-55-...	557975	EAMM-A-L27-55A
se servomotorem a převodovkou		
EMME-AS-40-...	557974	EAMM-A-L27-40G
EMGA-40-P-G...-EAS-40		
EMMS-AS-40-...	557974	EAMM-A-L27-40G
EMGA-40-P-G...-SAS-40		
s krokovým motorem		
EMMS-ST-57-...	560678	EAMM-A-L27-57A
s krokovým motorem a převodovkou		
EMMS-ST-42-...	557974	EAMM-A-L27-40G
EMGA-40-P-G...-SST-42		
<b>EGC-70</b>		
se servomotorem		
EMME-AS-60-...	2037246	EAMM-A-L38-60P
EMMS-AS-70-...	557979	EAMM-A-L38-70A
se servomotorem a převodovkou		
EMMS-AS-55-...	557978	EAMM-A-L38-60G
EMGA-60-P-G...-SAS-55		
EMMS-AS-70-...	557978	EAMM-A-L38-60G
EMGA-60-P-G...-SAS-70		
s krokovým motorem		
EMMS-ST-57-...	560679	EAMM-A-L38-57A
EMMS-ST-87-...	560680	EAMM-A-L38-87A
s krokovým motorem a převodovkou		
EMMS-ST-57-...	557978	EAMM-A-L38-60G
EMGA-60-P-G...-SST-57		
<b>EGC-80</b>		
se servomotorem		
EMMS-AS-70-...	557982	EAMM-A-L48-70A
EMME-AS-80-...	2042616	EAMM-A-L48-80P
EMMS-AS-100-...	557984	EAMM-A-L48-100A
se servomotorem a převodovkou		
EMMS-AS-55-...	557983	EAMM-A-L48-60G
EMGA-60-P-G...-SAS-55		
EMMS-AS-70-...	557983	EAMM-A-L48-60G
EMGA-60-P-G...-SAS-70		
s krokovým motorem		
EMMS-ST-87-...	560683	EAMM-A-L48-87A
s krokovým motorem a převodovkou		
EMMS-ST-57-...	557983	EAMM-A-L48-60G
EMGA-60-P-G...-SST-57		

motor/převodovka	axiální sada	
typ	č. dílu	typ
<b>EGC-120</b>		
se servomotorem		
EMME-AS-100-...	557988	EAMM-A-L62-100A
EMMS-AS-100-...	557988	EAMM-A-L62-100A
EMMS-AS-140-...	557990	EAMM-A-L62-140A
se servomotorem a převodovkou		
EMMS-AS-70-...	557989	EAMM-A-L62-80G
EMGA-80-P-G...-SAS-70		
EMME-AS-80-...	557989	EAMM-A-L62-80G
EMGA-80-P-G...-EAS-80		
EMME-AS-100-...	557989	EAMM-A-L62-80G
EMGA-80-P-G...-SAS-100		
EMMS-AS-100-...	557989	EAMM-A-L62-80G
EMGA-80-P-G...-SAS-100		
s krokovým motorem a převodovkou		
EMMS-ST-87-...	557989	EAMM-A-L62-80G
EMGA-80-P-G...-SST-87		
<b>EGC-185</b>		
se servomotorem		
EMMS-AS-140-...	557994	EAMM-A-L95-140A
EMMS-AS-190-...	1378474	EAMM-A-L95-190A
se servomotorem a převodovkou		
EMME-AS-100-...	557995	EAMM-A-L95-120G
EMGA-120-P-G...-SAS-100		
EMMS-AS-100-...	557995	EAMM-A-L95-120G
EMGA-120-P-G...-SAS-100		
EMMS-AS-140-...	557995	EAMM-A-L95-120G
EMGA-120-P-G...-SAS-140		

# Axiální sady EAMM-A

přehled dodávek

FESTO

Přípustné kombinace pohonů a motorů pro pohony s vřetenem EGC-BS

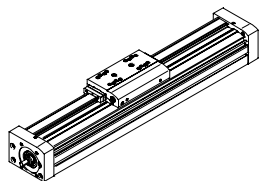

motor/převodovka	axiální sada	
typ	č. dílu	typ
<b>EGC-70</b>		
se servomotorem		
EMME-AS-40-...	2219044	EAMM-A-S38-40P
EMMS-AS-40-...	558162	EAMM-A-S38-40A
EMMS-AS-55-...	558163	EAMM-A-S38-55A
EMME-AS-60-...	2219110	EAMM-A-S38-60P
s krokovým motorem		
EMMS-ST-42-...	560685	EAMM-A-S38-42A
EMMS-ST-57-...	560686	EAMM-A-S38-57A
<b>EGC-80</b>		
se servomotorem		
EMMS-AS-55-...	558164	EAMM-A-S48-55A
EMME-AS-60-...	2220560	EAMM-A-S48-60P
EMMS-AS-70-...	558165	EAMM-A-S48-70A
s krokovým motorem		
EMMS-ST-57-...	560687	EAMM-A-S48-57A
EMMS-ST-87-...	560688	EAMM-A-S48-87A

motor/převodovka	axiální sada	
typ	č. dílu	typ
<b>EGC-120</b>		
se servomotorem		
EMMS-AS-70-...	558166	EAMM-A-S62-70A
EMME-AS-80-...	2222582	EAMM-A-S62-80P
EMME-AS-100-...	558167	EAMM-A-S62-100A
EMMS-AS-100-...	558167	EAMM-A-S62-100A
EMMS-AS-140-...	558168	EAMM-A-S62-140A
s krokovým motorem		
EMMS-ST-87-...	560689	EAMM-A-S62-87A
<b>EGC-185</b>		
se servomotorem		
EMME-AS-100-...	558169	EAMM-A-S95-100A
EMMS-AS-100-...	558169	EAMM-A-S95-100A
EMMS-AS-140-...	558170	EAMM-A-S95-140A

# Axiální sady EAMM-A

přehled dodávek

FESTO

Přípustné kombinace pohonů a motorů pro pohony s ozubeným řemenem ELGA-TB-...

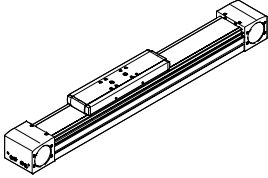

motor/převodovka	axiální sada	
typ	č. dílu	typ
<b>ELGA-TB-...-70</b>		
se servomotorem		
<b>EMMS-AS-70-...</b>	<b>1202331</b>	<b>EAMM-A-N38-70A</b>
se servomotorem a převodovkou		
<b>EMMS-AS-55-...</b> <b>EMGA-60-P-G...-SAS-55</b>	<b>1202253</b>	<b>EAMM-A-N38-60G</b>
<b>EMMS-AS-70-...</b> <b>EMGA-60-P-G...-SAS-70</b>	<b>1202253</b>	<b>EAMM-A-N38-60G</b>
s krokovým motorem		
<b>EMMS-ST-87-...</b>	<b>3324111</b>	<b>EAMM-A-N38-87A</b>
s krokovým motorem a převodovkou		
<b>EMMS-ST-57-...</b> <b>EMGA-60-P-G...-SST-57</b>	<b>1202253</b>	<b>EAMM-A-N38-60G</b>
<b>ELGA-TB-...-80</b>		
se servomotorem		
<b>EMMS-AS-100-...</b>	<b>1201894</b>	<b>EAMM-A-N48-100A</b>
se servomotorem a převodovkou		
<b>EMMS-AS-70-...</b> <b>EMGA-80-P-G...-SAS-70</b>	<b>1258793</b>	<b>EAMM-A-N48-80G</b>
<b>EMME-AS-80-...</b> <b>EMGA-80-P-G...-EAS-80</b>	<b>1258793</b>	<b>EAMM-A-N48-80G</b>
<b>EMME-AS-100-...</b> <b>EMGA-80-P-G...-SAS-100</b>	<b>1258793</b>	<b>EAMM-A-N48-80G</b>
<b>EMMS-AS-100-...</b> <b>EMGA-80-P-G...-SAS-100</b>	<b>1258793</b>	<b>EAMM-A-N48-80G</b>
s krokovým motorem a převodovkou		
<b>EMMS-ST-57-...</b> <b>EMGA-60-P-G...-SST-57</b>	<b>1972527</b>	<b>EAMM-A-N48-60G</b>
<b>EMMS-ST-87-...</b> <b>EMGA-80-P-G...-SST-87</b>	<b>1258793</b>	<b>EAMM-A-N48-80G</b>

motor/převodovka	axiální sada	
typ	č. dílu	typ
<b>ELGA-TB-...-120</b>		
se servomotorem		
<b>EMMS-AS-140-...</b>	<b>1201691</b>	<b>EAMM-A-N80-140A</b>
se servomotorem a převodovkou		
<b>EMMS-AS-70-...</b> <b>EMGA-80-P-G...-SAS-70</b>	<b>2372096</b>	<b>EAMM-A-N80-80G</b>
<b>EMME-AS-80-...</b> <b>EMGA-80-P-G...-EAS-80</b>	<b>2372096</b>	<b>EAMM-A-N80-80G</b>
<b>EMME-AS-100-...</b> <b>EMGA-80-P-G...-SAS-100</b>	<b>2372096</b>	<b>EAMM-A-N80-80G</b>
<b>EMMS-AS-100-...</b> <b>EMGA-80-P-G...-SAS-100</b>	<b>2372096</b>	<b>EAMM-A-N80-80G</b>
<b>EMME-AS-100-...</b> <b>EMGA-120-P-G...-SAS-100</b>	<b>1201695</b>	<b>EAMM-A-N80-120G</b>
<b>EMMS-AS-100-...</b> <b>EMGA-120-P-G...-SAS-100</b>	<b>1201695</b>	<b>EAMM-A-N80-120G</b>
<b>EMMS-AS-140-...</b> <b>EMGA-120-P-G...-SAS-140</b>	<b>1201695</b>	<b>EAMM-A-N80-120G</b>
s krokovým motorem a převodovkou		
<b>EMMS-ST-87-...</b> <b>EMGA-80-P-G...-SST-87</b>	<b>2372096</b>	<b>EAMM-A-N80-80G</b>

# Axiální sady EAMM-A

přehled dodávek

FESTO

## Přípustné kombinace pohonů a motorů pro pohony s ozubeným řemenem EGC-HD-TB

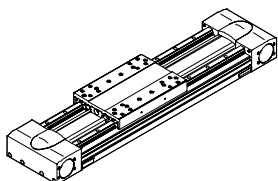

motor/převodovka	axiální sada	
typ	č. dílu	typ
<b>EGC-HD-125</b>		
se servomotorem a převodovkou		
EMMS-AS-55-... EMGA-60-P-G...-SAS-55	1190076	EAMM-A-M43-60G
EMMS-AS-70-... EMGA-60-P-G...-SAS-70	1190076	EAMM-A-M43-60G
s krokovým motorem a převodovkou		
EMMS-ST-57-... EMGA-60-P-G...-SST-57	1190076	EAMM-A-M43-60G
<b>EGC-HD-160</b>		
se servomotorem a převodovkou		
EMMS-AS-70-... EMGA-80-P-G...-SAS-70	1190421	EAMM-A-M48-80G
EMME-AS-80-... EMGA-80-P-G...-EAS-80	1190421	EAMM-A-M48-80G

motor/převodovka	axiální sada	
typ	č. dílu	typ
<b>EGC-HD-160</b>		
se servomotorem a převodovkou		
EMME-AS-100-... EMGA-80-P-G...-SAS-100	1190421	EAMM-A-M48-80G
EMMS-AS-100-... EMGA-80-P-G...-SAS-100	1190421	EAMM-A-M48-80G
s krokovým motorem a převodovkou		
EMMS-ST-87-... EMGA-80-P-G...-SST-87	1190421	EAMM-A-M48-80G
<b>EGC-HD-220</b>		
se servomotorem a převodovkou		
EMMS-AS-100-... EMGA-120-P-G...-SAS-100	1190774	EAMM-A-M80-120G
EMMS-AS-140-... EMGA-120-P-G...-SAS-140	1190774	EAMM-A-M80-120G

## Přípustné kombinace pohonů a motorů pro pohony s vřetenem EGC-HD-BS

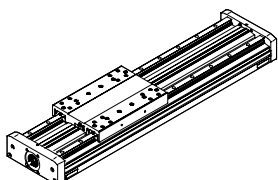

motor	axiální sada	
typ	č. dílu	typ
<b>EGC-HD-125</b>		
se servomotorem		
EMME-AS-40-... EMMS-AS-40-... EMMS-AS-55-... EMME-AS-60-...	2219044 558162 558163 2219110	EAMM-A-S38-40P EAMM-A-S38-40A EAMM-A-S38-55A EAMM-A-S38-60P
s krokovým motorem		
EMMS-ST-42-... EMMS-ST-57-...	560685 560686	EAMM-A-S38-42A EAMM-A-S38-57A
<b>EGC-HD-160</b>		
se servomotorem		
EMMS-AS-55-... EMME-AS-60-... EMMS-AS-70-...	558164 2220560 558165	EAMM-A-S48-55A EAMM-A-S48-60P EAMM-A-S48-70A
s krokovým motorem		
EMMS-ST-57-... EMMS-ST-87-...	560687 560688	EAMM-A-S48-57A EAMM-A-S48-87A

motor	axiální sada	
typ	č. dílu	typ
<b>EGC-HD-220</b>		
se servomotorem		
EMMS-AS-70-... EMME-AS-80-... EMME-AS-100-... EMMS-AS-100-... EMMS-AS-140-...	558166 2222582 558167 558167 558168	EAMM-A-S62-70A EAMM-A-S62-80P EAMM-A-S62-100A EAMM-A-S62-100A EAMM-A-S62-140A
s krokovým motorem		
EMMS-ST-87-...	560689	EAMM-A-S62-87A

# Axiální sady EAMM-A

přehled dodávek

FESTO

Přípustné kombinace pohonů a motorů pro saně Mini EGSL

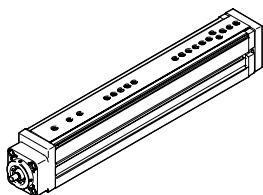

motor/převodovka	axiální sada	
typ	č. dílu	typ
<b>EGSL-35</b>		
se servomotorem		
EMME-AS-40-...	1981953	EAMM-A-D19-40P
EMMS-AS-40-...	1199152	EAMM-A-D19-40A
s krokovým motorem		
EMMS-ST-28-...	1081659	EAMM-A-D19-28A
EMMS-ST-42-...	1087642	EAMM-A-D19-42A
<b>EGSL-45</b>		
se servomotorem		
EMME-AS-40-...	1976465	EAMM-A-D32-40P
EMMS-AS-40-...	543147	EAMM-A-D32-40A
EMMS-AS-55-...	550979	EAMM-A-D32-55A
EMME-AS-60-...	1956054	EAMM-A-D32-60P
s krokovým motorem		
EMMS-ST-42-...	543148	EAMM-A-D32-42A
EMMS-ST-57-...	550980	EAMM-A-D32-57A
<b>EGSL-55</b>		
se servomotorem		
EMMS-AS-55-...	543153	EAMM-A-D40-55A
EMME-AS-60-...	1977000	EAMM-A-D40-60P
EMMS-AS-70-...	550981	EAMM-A-D40-70A
se servomotorem a převodovkou		
EMME-AS-40-... EMGA-40-P-G...-EAS-40	560282	EAMM-A-D40-40G
EMMS-AS-40-... EMGA-40-P-G...-SAS-40	560282	EAMM-A-D40-40G
s krokovým motorem		
EMMS-ST-57-...	543154	EAMM-A-D40-57A
EMMS-ST-87-...	550982	EAMM-A-D40-87A
s krokovým motorem a převodovkou		
EMMS-ST-42-... EMGA-40-P-G...-SST-42	560282	EAMM-A-D40-40G

motor/převodovka	axiální sada	
typ	č. dílu	typ
<b>EGSL-75</b>		
se servomotorem		
EMMS-AS-70-...	543161	EAMM-A-D60-70A
EMME-AS-80-...	1977073	EAMM-A-D60-80P
EMMS-AS-100-...	550983	EAMM-A-D60-100A
EMMS-AS-100-...	550983	EAMM-A-D60-100A
se servomotorem a převodovkou		
EMMS-AS-55-... EMGA-60-P-G...-SAS-55	560283	EAMM-A-D60-60G
EMME-AS-70-... EMGA-60-P-G...-EAS-70	560283	EAMM-A-D60-60G
s krokovým motorem		
EMMS-ST-87-...	543162	EAMM-A-D60-87A
s krokovým motorem a převodovkou		
EMMS-ST-57-... EMGA-60-P-G...-SST-57	560283	EAMM-A-D60-60G

# Axiální sady EAMM-A

přehled dodávek

FESTO

Přípustné kombinace pohonů a motorů pro elektrické saně EGSK, EGSP

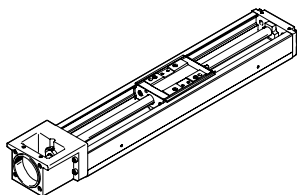

motor/převodovka	axiální sada	
typ	č. dílu	typ
<b>EGSK-15</b>		
se servomotorem		
EMME-AS-40-...	1982886	EAMM-A-P3-28D-40P
s krokovým motorem		
EMMS-ST-28-...	1703478	EAMM-A-P3-28D-28A
<b>EGSK-20/EGSP-20</b>		
se servomotorem		
EMME-AS-40-...	1983071	EAMM-A-P4-28B-40P
EMMS-AS-40-...	562637	EAMM-A-P4-28B-40A
s krokovým motorem		
EMMS-ST-28-...	1731466	EAMM-A-P4-28B-28A
EMMS-ST-42-...	562636	EAMM-A-P4-28B-42A
<b>EGSK-26/EGSP-26</b>		
se servomotorem		
EMME-AS-40-...	1983122	EAMM-A-P5-28B-40P
EMMS-AS-40-...	562641	EAMM-A-P5-28B-40A
s krokovým motorem		
EMMS-ST-28-...	1731474	EAMM-A-P5-28B-28A
EMMS-ST-42-...	562640	EAMM-A-P5-28B-42A
<b>EGSK-33</b>		
se servomotorem		
EMME-AS-40-...	1983450	EAMM-A-P6-38A-40P
EMMS-AS-40-...	562646	EAMM-A-P6-38A-40A
EMMS-AS-55-...	562647	EAMM-A-P6-38A-55A
EMME-AS-60-...	2264375	EAMM-A-P6-38A-60P
s krokovým motorem		
EMMS-ST-42-...	562644	EAMM-A-P6-38A-42A
EMMS-ST-57-...	562645	EAMM-A-P6-38A-57A

motor/převodovka	axiální sada	
typ	č. dílu	typ
<b>EGSK-46/EGSP-33</b>		
se servomotorem		
EMME-AS-40-...	1986292	EAMM-A-P8-38A-40P
EMMS-AS-40-...	562652	EAMM-A-P8-38A-40A
EMMS-AS-55-...	562653	EAMM-A-P8-38A-55A
EMME-AS-60-...	1987308	EAMM-A-P8-38A-60P
EMMS-AS-70-...	564996	EAMM-A-P8-38A-70A
s krokovým motorem		
EMMS-ST-42-...	562650	EAMM-A-P8-38A-42A
EMMS-ST-57-...	562651	EAMM-A-P8-38A-57A
EMMS-ST-87-...	564998	EAMM-A-P8-38A-87A
<b>EGSP-46</b>		
se servomotorem		
EMMS-AS-55-...	562659	EAMM-A-P10-38A-55A
EMME-AS-60-...	2036017	EAMM-A-P10-38A-60P
EMMS-AS-70-...	564997	EAMM-A-P10-38A-70A
s krokovým motorem		
EMMS-ST-57-...	562658	EAMM-A-P10-38A-57A
EMMS-ST-87-...	564999	EAMM-A-P10-38A-87A

# Axiální sady EAMM-A

přehled dodávek

FESTO

## Přípustné kombinace pohonů a motorů pro letmé pohony DGEA

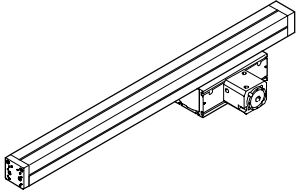

motor/převodovka	axiální sada	
typ	č. dílu	typ
<b>DGEA-18</b>		
s krokovým motorem		
EMMS-ST-57-...	550956	EAMM-A-F28-57A
EMMS-ST-87-...	550958	EAMM-A-F28-87A
se servomotorem a převodovkou		
EMMS-AS-55-...	550957	EAMM-A-F28-60G
EMGA-60-P-G...-SAS-55		
EMMS-AS-70-...	550957	EAMM-A-F28-60G
EMGA-60-P-G...-SAS-70		
s krokovým motorem a převodovkou		
EMMS-ST-57-...	550957	EAMM-A-F28-60G
EMGA-60-P-G...-SST-57		
<b>DGEA-25</b>		
se servomotorem a převodovkou		
EMMS-AS-55-...	550959	EAMM-A-F32-60G
EMGA-60-P-G...-SAS-55		
EMMS-AS-70-...	550959	EAMM-A-F32-60G
EMGA-60-P-G...-SAS-70		
s krokovým motorem		
EMMS-ST-87-...	550960	EAMM-A-F32-87A

motor/převodovka	axiální sada	
typ	č. dílu	typ
<b>DGEA-40</b>		
se servomotorem a převodovkou		
EMMS-AS-70-...	550935	EAMM-A-F40-80G
EMGA-80-P-G...-SAS-70		
EMME-AS-80-...	550935	EAMM-A-F40-80G
EMGA-80-P-G...-EAS-80		
EMME-AS-100-...	550935	EAMM-A-F40-80G
EMGA-80-P-G...-SAS-100		
EMMS-AS-100-...	550935	EAMM-A-F40-80G
EMGA-80-P-G...-SAS-100		
s krokovým motorem a převodovkou		
EMMS-ST-87-...	550935	EAMM-A-F40-80G
EMGA-80-P-G...-SST-87		



# Axiální sady EAMM-A

přehled dodávek

FESTO

## Přípustné kombinace pohonů a motorů pro pohony s ozubeným řemenem ELGG

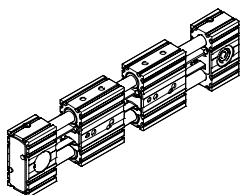

motor/převodovka	axiální sada	
typ	č. dílu	typ
<b>ELGG-35</b>		
se servomotorem		
EMMS-AS-55-...	1133400	EAMM-A-R27-55A
s krokovým motorem		
EMMS-ST-57-...	1133403	EAMM-A-R27-57A
<b>ELGG-45</b>		
se servomotorem		
EMME-AS-60-...	2224996	EAMM-A-R38-60P
EMMS-AS-70-...	1133401	EAMM-A-R38-70A
s krokovým motorem		
EMMS-ST-57-...	1578138	EAMM-A-R38-57A
EMMS-ST-87-...	1133404	EAMM-A-R38-87A

motor/převodovka	axiální sada	
typ	č. dílu	typ
<b>ELGG-55</b>		
se servomotorem		
EMMS-AS-70-...	1578139	EAMM-A-R48-70A
EMME-AS-80-...	2225090	EAMM-A-R48-80P
EMME-AS-100-...	1133402	EAMM-A-R48-100A
EMMS-AS-100-...	1133402	EAMM-A-R48-100A
s krokovým motorem		
EMMS-ST-87-...	1133405	EAMM-A-R48-87A

## Přípustné kombinace pohonů a motorů pro pohony s ozubeným řemenem ELGR

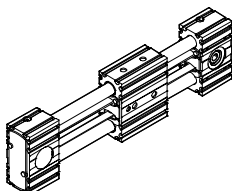

motor	axiální sada	
typ	č. dílu	typ
<b>ELGR-35</b>		
se servomotorem		
EMMS-AS-55-...	1133400	EAMM-A-R27-55A
s krokovým motorem		
EMMS-ST-57-...	1133403	EAMM-A-R27-57A
<b>ELGR-45</b>		
se servomotorem		
EMME-AS-60-...	2224996	EAMM-A-R38-60P
EMMS-AS-70-...	1133401	EAMM-A-R38-70A
s krokovým motorem		
EMMS-ST-57-...	1578138	EAMM-A-R38-57A
EMMS-ST-87-...	1133404	EAMM-A-R38-87A

motor	axiální sada	
typ	č. dílu	typ
<b>ELGR-55</b>		
se servomotorem		
EMMS-AS-70-...	1578139	EAMM-A-R48-70A
EMME-AS-80-...	2225090	EAMM-A-R48-80P
EMME-AS-100-...	1133402	EAMM-A-R48-100A
EMMS-AS-100-...	1133402	EAMM-A-R48-100A
s krokovým motorem		
EMMS-ST-87-...	1133405	EAMM-A-R48-87A

# Axiální sady EAMM-A

přehled dodávek

FESTO

## Přípustné kombinace pohonů a motorů pro otočné moduly ERMB

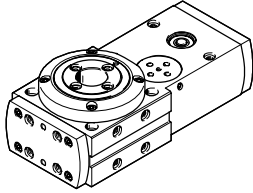

motor/převodovka	axiální sada	
typ	č. dílu	typ
<b>ERMB-20</b>		
se servomotorem		
EMME-AS-40-...	2207441	EAMM-A-D32-35A-40P
EMMS-AS-40-...	560281	EAMM-A-D32-35A-40A
s krokovým motorem		
EMMS-ST-42-...	543148	EAMM-A-D32-42A
EMMS-ST-57-...	550980	EAMM-A-D32-57A
s jednotkou motoru		
MTR-DCI-32S-...	543149	EAMM-A-D32-32B
<b>ERMB-25</b>		
se servomotorem		
EMMS-AS-55-...	543153	EAMM-A-D40-55A
EMME-AS-60-...	1977000	EAMM-A-D40-60P
EMMS-AS-70-...	550981	EAMM-A-D40-70A
se servomotorem a převodovkou		
EMME-AS-40-...	560282	EAMM-A-D40-40G
EMGA-40-P-G-...-EAS-40		
EMMS-AS-40-...	560282	EAMM-A-D40-40G
EMGA-40-P-G-...-SAS-40		
s krokovým motorem		
EMMS-ST-57-...	543154	EAMM-A-D40-57A
s krokovým motorem a převodovkou		
EMMS-ST-42-...	560282	EAMM-A-D40-40G
EMGA-40-P-G-...-SST-42		
s jednotkou motoru		
MTR-DCI-42S-...-G7	543155	EAMM-A-D40-42B
MTR-DCI-42S-...-G14	543156	EAMM-A-D40-42C

motor/převodovka	axiální sada	
typ	č. dílu	typ
<b>ERMB-32</b>		
se servomotorem		
EMMS-AS-70-...	543161	EAMM-A-D60-70A
EMME-AS-80-...	1977073	EAMM-A-D60-80P
EMMS-AS-100-...	550983	EAMM-A-D60-100A
EMMS-AS-100-...	550983	EAMM-A-D60-100A
se servomotorem a převodovkou		
EMMS-AS-55-...	560283	EAMM-A-D60-60G
EMGA-60-P-G-...-SAS-55		
EMMS-AS-70-...	560283	EAMM-A-D60-60G
EMGA-60-P-G-...-SAS-70		
s krokovým motorem		
EMMS-ST-87-...	543162	EAMM-A-D60-87A
s krokovým motorem a převodovkou		
EMMS-ST-57-...	560283	EAMM-A-D60-60G
EMGA-60-P-G-...-SST-57		
s jednotkou motoru		
MTR-DCI-52S-...-G7	543163	EAMM-A-D60-52B
MTR-DCI-52S-...-G14	543164	EAMM-A-D60-52C

# Axiální sady EAMM-A

přehled dodávek

FESTO

## Přípustné kombinace pohonů a motorů pro kyvně-přimočaré moduly EHMB

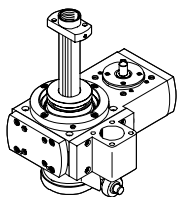

pro kyvný pohyb		axiální sada	
motor/převodovka	č. dílu	typ	
<b>EHMB-20</b>			
se servomotorem			
EMME-AS-40-...	2207441	EAMM-A-D32-35A-40P	
EMMS-AS-40-...	560281	EAMM-A-D32-35A-40A	
s krokovým motorem			
EMMS-ST-42-...	543148	EAMM-A-D32-42A	
EMMS-ST-57-...	550980	EAMM-A-D32-57A	
s jednotkou motoru			
MTR-DCI-32S-...	543149	EAMM-A-D32-32B	
<b>EHMB-25</b>			
se servomotorem			
EMMS-AS-55-...	543153	EAMM-A-D40-55A	
EMME-AS-60-...	1977000	EAMM-A-D40-60P	
EMMS-AS-70-...	550981	EAMM-A-D40-70A	
se servomotorem a převodovkou			
EMME-AS-40-...	560282	EAMM-A-D40-40G	
EMGA-40-P-G...-EAS-40			
EMMS-AS-40-...	560282	EAMM-A-D40-40G	
EMGA-40-P-G...-SAS-40			
s krokovým motorem			
EMMS-ST-57-...	543154	EAMM-A-D40-57A	
s krokovým motorem a převodovkou			
EMMS-ST-42-...	560282	EAMM-A-D40-40G	
EMGA-40-P-G...-SST-42			
s jednotkou motoru			
MTR-DCI-42S-...-G7	543155	EAMM-A-D40-42B	
MTR-DCI-42S-...-G14	543156	EAMM-A-D40-42C	

pro kyvný pohyb		axiální sada	
motor/převodovka	č. dílu	typ	
<b>EHMB-32</b>			
se servomotorem			
EMMS-AS-70-...	543161	EAMM-A-D60-70A	
EMME-AS-80-...	1977073	EAMM-A-D60-80P	
EMME-AS-100-...	550983	EAMM-A-D60-100A	
EMMS-AS-100-...	550983	EAMM-A-D60-100A	
se servomotorem a převodovkou			
EMMS-AS-55-...	560283	EAMM-A-D60-60G	
EMGA-60-P-G...-SAS-55			
EMMS-AS-70-...	560283	EAMM-A-D60-60G	
EMGA-60-P-G...-SAS-70			
s krokovým motorem			
EMMS-ST-87-...	543162	EAMM-A-D60-87A	
s krokovým motorem a převodovkou			
EMMS-ST-57-...	560283	EAMM-A-D60-60G	
EMGA-60-P-G...-SST-57			
s jednotkou motoru			
MTR-DCI-52S-...-G7	543163	EAMM-A-D60-52B	
MTR-DCI-52S-...-G14	543164	EAMM-A-D60-52C	

# Axiální sady EAMM-A

technické údaje

FESTO

materiál:

těleso spojky, náboje spojky, příruba

motoru: hliník

šrouby: pozinkovaná ocel



Obecné technické údaje						
typ	pro pohon	přenositelný točivý moment [Nm]	moment setrvačnosti [kgm <sup>2</sup> ]	max. otáčky [1/min]	hmotnost [g]	→ strana
EAMM-A-D19-28A	EGSL	1,1	0,28	10000	80	32
EAMM-A-D19-40A	EGSL	1,1	0,28	10000	110	
EAMM-A-D19-42A	EGSL	1,1	0,28	10000	130	
EAMM-A-D19-40P	EGSL	1,1	0,28	10000	110	
EAMM-A-D32-32B	DNCE, EHMB, ERMB	1,1	0,28	10000	150	
EAMM-A-D32-40A	DNCE, EGSL	1,1	0,28	10000	130	
EAMM-A-D32-40P	DNCE, EGSL	1,1	0,28	10000	160	
EAMM-A-D32-35A-40A	EHMB, ERMB	4	5,87	8000	220	
EAMM-A-D32-35A-40P	EHMB, ERMB	4	5,87	8000	160	
EAMM-A-D32-42A	DNCE, EGSL, EHMB, ERMB	0,8	0,3	10000	140	
EAMM-A-D32-55A	DNCE, EGSL, EHMB	4	5,87	8000	260	
EAMM-A-D32-57A	DNCE, EGSL, EHMB, ERMB	4	5,87	8000	270	
EAMM-A-D32-60P	DNCE, EGSL, EHMB, ERMB	4	5,87	8000	410	
EAMM-A-D40-40G	DNCE, EHMB, ERMB, EGSL	8	5,87	8000	350	
EAMM-A-D40-42B	DNCE, EHMB, ERMB	8	5,87	8000	340	
EAMM-A-D40-42C	DNCE, EHMB, ERMB	8	5,87	8000	370	
EAMM-A-D40-55A	DNCE, EGSL, EHMB, ERMB	8	5,87	8000	350	
EAMM-A-D40-57A	DNCE, EGSL, EHMB, ERMB	6	5,87	8000	350	
EAMM-A-D40-60P	DNCE, EGSL, EHMB, ERMB	8	5,87	8000	430	
EAMM-A-D40-70A	DNCE, EGSL, EHMB, ERMB	8	5,87	8000	410	
EAMM-A-D40-87A	DNCE, EGSL, EHMB, ERMB	8	5,87	8000	530	
EAMM-A-D60-52C	DNCE, EHMB, ERMB	14	34,8	6000	1020	
EAMM-A-D60-60G	DNCE, EHMB, ERMB, ESBF, EGSL	12	34,8	6000	830	
EAMM-A-D60-70A	DNCE, EGSL, EHMB, ERMB, ESBF	12	34,8	6000	750	
EAMM-A-D60-80P	DNCE, EGSL, EHMB, ERMB, ESBF	14	34,8	6000	1040	
EAMM-A-D60-87A	DNCE, EGSL, EHMB, ERMB, ESBF	12	34,8	6000	890	
EAMM-A-D60-100A	DNCE, EGSL, EHMB, ERMB, ESBF	14	34,8	6000	1170	
EAMM-A-D80-100A	ESBF	60	128	5500	2030	
EAMM-A-D80-140A	ESBF	60	128	5500	2920	
EAMM-A-D100-140A	ESBF	143	280	4500	3460	

# Axiální sady EAMM-A

technické údaje

FESTO

Obecné technické údaje							
typ	pro pohon	přenositelný točivý moment [Nm]	moment setrvačnosti [kgm <sup>2</sup> ]	max. otáčky [1/min]	hmotnost [g]	→ strana	
EAMM-A-E20-32B	DMES	1,5	0,23	10000	100	30	
EAMM-A-E20-40A	DGE-SP, DMES	1	0,13	12000	80		
EAMM-A-E20-42A	DGE-SP, DMES	1	0,13	12000	100		
EAMM-A-E20-55A	DGE-SP, DMES	1	0,13	12000	140		
EAMM-A-E32-40A	DGE-SP, DMES	7,5	6,1	8000	250		
EAMM-A-E32-42B	DMES	6,5	5,87	8000	340		
EAMM-A-E32-42C	DMES	6,5	5,87	8000	380		
EAMM-A-E32-55A	DGE-SP, DMES	7,5	6,1	8000	280		
EAMM-A-E32-57A	DGE-SP, DMES	7,5	6,1	8000	290		
EAMM-A-E48-52B	DMES	17	34,8	6000	1120		
EAMM-A-E48-52C	DMES	17	34,8	6000	1210		
EAMM-A-E48-55A	DGE-SP	8,5	6,1	8000	530		
EAMM-A-E48-57A	DGE-SP	7,5	6,1	8000	540		
EAMM-A-E48-44A-70A	DGE-SP	9,2	6,1	8000	600		
EAMM-A-E48-64A-70A	DMES	17	42,3	6500	790		
EAMM-A-E48-87A	DGE-SP, DMES	17	42,3	6500	1500		
EAMM-A-E48-100A	DGE-SP, DMES	17	42,3	6500	1280		
EAMM-A-E48-40G	DGE-SP	8,8	6,1	8000	550		
EAMM-A-E72-62B	DMES	17	35,5	6000	2800		
EAMM-A-E72-70A	DGE-SP, DMES	17	42,3	6500	2370		
EAMM-A-E72-87A	DGE-SP, DMES	17	42,3	6500	3040		
EAMM-A-E72-100A	DGE-SP, DMES	17	42,3	6500	3240		
EAMM-A-E72-60G	DGE-SP, DMES	17	42,3	6500	3190		
EAMM-A-E72-80G	DGE-SP, DMES	17	42,3	6500	3190		
EAMM-A-F28-57A	DGEA	7,5	6,1	8000	280		49
EAMM-A-F28-60G	DGEA	8,2	6,1	8000	350		
EAMM-A-F28-87A	DGEA	8,2	6,1	8000	450		
EAMM-A-F30-55A	DGE-ZR	8,2	6,1	8000	270	26	
EAMM-A-F30-57A	DGE-ZR	7,5	6,1	8000	280		
EAMM-A-F30-60G	DGE-ZR	8,2	6,1	8000	410		
EAMM-A-F30-70A	DGE-ZR	8,2	6,1	8000	330		
EAMM-A-F30-87A	DGE-ZR	8,2	6,1	8000	440		
EAMM-A-F32-60G	DGEA	17	42,3	6500	920	49	
EAMM-A-F32-87A	DGEA	17	42,3	6500	770		
EAMM-A-F37-55A	DGE-ZR	8,2	6,1	8000	270	26	
EAMM-A-F37-57A	DGE-ZR	7,5	6,1	8000	270		
EAMM-A-F37-70A	DGE-ZR	8,2	6,1	8000	330		
EAMM-A-F37-87A	DGE-ZR	8,2	6,1	8000	480		
EAMM-A-F37-60G	DGE-ZR	8,2	6,1	8000	350		
EAMM-A-F40-70A	DGE-ZR	17	42,3	6500	640		
EAMM-A-F40-80G	DGE-ZR, DGEA	17	42,3	6500	890	49	

# Axiální sady EAMM-A

technické údaje

FESTO

Obecné technické údaje						
typ	pro pohon	přenositelný točivý moment [Nm]	moment setrvačnosti [kgm <sup>2</sup> ]	max. otáčky [1/min]	hmotnost [g]	→ strana
EAMM-A-F40-87A	DGE-ZR	17	42,3	6500	790	26
EAMM-A-F40-100A	DGE-ZR	17	42,3	6500	940	
EAMM-A-F40-80G	DGE-ZR	17	42,3	6500	890	
EAMM-A-F47-87A	DGE-ZR	17	42,3	6500	780	
EAMM-A-F47-100A	DGE-ZR	17	42,3	6500	1010	
EAMM-A-F47-140A	DGE-ZR	17	42,3	6500	1930	
EAMM-A-F47-80G	DGE-ZR	17	42,3	6500	1000	
EAMM-A-F62-100A	DGE-ZR	85	417	4500	2540	
EAMM-A-F62-140A	DGE-ZR	92	417	4500	2780	
EAMM-A-F62-80G	DGE-ZR	85	417	4500	2760	
EAMM-A-F62-120G	DGE-ZR	92	417	4500	2480	
EAMM-A-F80-100A	DGE-ZR	85	417	4500	2560	
EAMM-A-F80-140A	DGE-ZR	92	417	4500	2 640	
EAMM-A-F80-80G	DGE-ZR	85	417	4500	2810	
EAMM-A-F80-120G	DGE-ZR	92	417	4500	2730	
EAMM-A-F80-160G	DGE-ZR	92	417	4500	5240	
EAMM-A-G13-40A	DGE-ZR	1	0,13	12000	80	
EAMM-A-G13-42A	DGE-ZR	1	0,13	12000	90	
EAMM-A-G16-40A	DGE-ZR	1	0,13	12000	80	
EAMM-A-G16-42A	DGE-ZR	1	0,13	12000	120	
EAMM-A-G16-55A	DGE-ZR	1	0,13	12000	140	
EAMM-A-G19-40A	DGE-ZR	1,5	0,47	8000	160	
EAMM-A-G19-55A	DGE-ZR	1,5	0,47	8000	190	
EAMM-A-G19-57A	DGE-ZR	1,5	0,47	8000	200	
EAMM-A-L27-55A	EGC-TB	2	0,445	10000	220	38
EAMM-A-L27-57A	EGC-TB	1,6	0,355	10000	180	
EAMM-A-L27-40G	EGC-TB	2	0,445	10000	180	
EAMM-A-L38-57A	EGC-TB	3,6	3,2	8000	220	
EAMM-A-L38-60G	EGC-TB	4,4	3,2	8000	350	
EAMM-A-L38-60P	EGC-TB	4,4	3,3	8000	300	
EAMM-A-L38-70A	EGC-TB	4,4	3,2	8000	290	
EAMM-A-L38-87A	EGC-TB	4,4	3,2	8000	480	
EAMM-A-L48-70A	EGC-TB	12,5	14,5	8000	350	
EAMM-A-L48-80P	EGC-TB	17	39	6000	660	
EAMM-A-L48-87A	EGC-TB	12,5	14,5	8000	590	
EAMM-A-L48-100A	EGC-TB	17	39	6000	990	
EAMM-A-L48-60G	EGC-TB	12,5	14,5	8000	490	
EAMM-A-L62-100A	EGC-TB	47	147	5500	1610	
EAMM-A-L62-140A	EGC-TB	47	147	5500	2420	
EAMM-A-L62-80G	EGC-TB	47	147	5500	1620	
EAMM-A-L95-140A	EGC-TB	143	374	4500	3710	
EAMM-A-L95-190A	EGC-TB	192	374	4500	5280	
EAMM-A-L95-120G	EGC-TB	150	374	4500	3660	

# Axiální sady EAMM-A

technické údaje

FESTO

Obecné technické údaje						
typ	pro pohon	přenositelný točivý moment [Nm]	moment setrvačnosti [kgm <sup>2</sup> ]	max. otáčky [1/min]	hmotnost [g]	→ strana
EAMM-A-M43-60G	EGC-HD-TB	12,5	14,5	8000	340	43
EAMM-A-M48-80G	EGC-HD-TB	21	39	6000	870	
EAMM-A-M80-120G	EGC-HD-TB	75	147	5500	1370	
EAMM-A-N38-70A	ELGA	12,5	14,5	8000	430	42
EAMM-A-N38-87A	ELGA	12,5	14,5	8000	646	
EAMM-A-N38-60G	ELGA	12,5	14,5	8000	470	42
EAMM-A-N48-100A	ELGA	17	39	6000	1070	
EAMM-A-N48-60G	ELGA	12,5	14,5	8000	509	42
EAMM-A-N48-80G	ELGA	21	39	6000	1080	
EAMM-A-N80-80G	ELGA	60	147	5500	1290	
EAMM-A-N80-120G	ELGA	60	147	5500	1990	
EAMM-A-N80-140A	ELGA	60	147	5500	2070	40, 44
EAMM-A-S38-40A	EGC-BS, EGC-HD-BS	6,5	5,87	8000	370	
EAMM-A-S38-40P	EGC-BS, EGC-HD-BS	6,5	5,87	8000	380	
EAMM-A-S38-42A	EGC-BS, EGC-HD-BS	3,5	5,87	8000	410	
EAMM-A-S38-55A	EGC-BS, EGC-HD-BS	6,5	5,87	8000	400	
EAMM-A-S38-57A	EGC-BS, EGC-HD-BS	6,5	5,87	8000	400	
EAMM-A-S38-60P	EGC-BS, EGC-HD-BS	6,5	5,87	8000	530	
EAMM-A-S48-55A	EGC-BS, EGC-HD-BS	12,5	5,87	8000	590	
EAMM-A-S48-57A	EGC-BS, EGC-HD-BS	6,5	5,87	8000	580	
EAMM-A-S48-60P	EGC-BS, EGC-HD-BS	12,5	5,87	8000	580	
EAMM-A-S48-70A	EGC-BS, EGC-HD-BS	12,5	5,87	8000	610	
EAMM-A-S48-87A	EGC-BS, EGC-HD-BS	12,5	5,87	8000	760	
EAMM-A-S62-70A	EGC-BS, EGC-HD-BS	17	45,5	6000	1950	
EAMM-A-S62-80P	EGC-BS, EGC-HD-BS	17	34,8	6000	1890	
EAMM-A-S62-87A	EGC-BS, EGC-HD-BS	17	45,5	6000	2070	
EAMM-A-S62-100A	EGC-BS, EGC-HD-BS	17	34,8	6000	2050	
EAMM-A-S62-140A	EGC-BS, EGC-HD-BS	17	34,8	6000	2870	
EAMM-A-S95-100A	EGC-BS	60	128	5500	4910	
EAMM-A-S95-140A	EGC-BS	60	128	5500	5500	

# Axiální sady EAMM-A

technické údaje

FESTO

Obecné technické údaje						
typ	pro pohon	přenositelný točivý moment [Nm]	moment setrvačnosti [kgm <sup>2</sup> ]	max. otáčky [1/min]	hmotnost [g]	→ strana
EAMM-A-P3-28D-28A	EGSK	0,2	0,28	10000	30	46
EAMM-A-P3-28D-40P	EGSK	0,2	0,28	10000	60	
EAMM-A-P4-28B-28A	EGSK, EGSP	0,7	0,28	10000	40	
EAMM-A-P4-28B-40A	EGSK, EGSP	0,7	0,28	10000	50	
EAMM-A-P4-28B-40P	EGSK, EGSP	0,7	0,28	10000	50	
EAMM-A-P4-28B-42A	EGSK, EGSP	0,7	0,28	10000	60	
EAMM-A-P5-28B-28A	EGSK, EGSP	1,1	0,28	10000	40	
EAMM-A-P5-28B-40A	EGSK, EGSP	1,1	0,28	10000	50	
EAMM-A-P5-28B-40P	EGSK, EGSP	1,1	0,28	10000	50	
EAMM-A-P5-28B-42A	EGSK, EGSP	1,1	0,28	10000	60	
EAMM-A-P6-38A-40A	EGSK, EGSP	6,5	5,87	8000	100	
EAMM-A-P6-38A-40P	EGSK	6,5	5,87	8000	110	
EAMM-A-P6-38A-42A	EGSK, EGSP	3,5	5,87	8000	160	
EAMM-A-P6-38A-55A	EGSK, EGSP	6,5	5,87	8000	130	
EAMM-A-P6-38A-57A	EGSK, EGSP	6,5	5,87	8000	130	
EAMM-A-P6-38A-60P	EGSK	6,5	5,87	8000	210	
EAMM-A-P8-38A-40A	EGSK, EGSP	6,5	5,87	8000	100	
EAMM-A-P8-38A-40P	EGSK, EGSP	12,5	5,87	8000	110	
EAMM-A-P8-38A-42A	EGSK, EGSP	3,5	5,87	8000	160	
EAMM-A-P8-38A-55A	EGSK, EGSP	12,5	5,87	8000	130	
EAMM-A-P8-38A-57A	EGSK, EGSP	6,5	5,87	8000	130	
EAMM-A-P8-38A-60P	EGSK, EGSK	12,5	5,87	8000	210	
EAMM-A-P8-38A-70A	EGSK, EGSP	12,5	5,87	8000	200	
EAMM-A-P8-38A-87A	EGSK, EGSP	12,5	5,87	8000	380	
EAMM-A-P10-38A-55A	EGSK, EGSP	12,5	5,87	8000	130	
EAMM-A-P10-38A-57A	EGSK, EGSP	6,5	5,87	8000	130	
EAMM-A-P10-38A-60P	EGSP	12,5	5,87	8000	210	
EAMM-A-P10-38A-70A	EGSK, EGSP	12,5	5,87	8000	200	
EAMM-A-P10-38A-87A	EGSK, EGSP	12,5	5,87	8000	380	
EAMM-A-R27-55A	ELGG, ELGR	2	0,445	10000	170	48
EAMM-A-R27-57A	ELGG, ELGR	1,6	0,355	10000	170	
EAMM-A-R38-57A	ELGG, ELGR	3,6	3,2	8000	280	
EAMM-A-R38-60P	ELGG, ELGR	4,4	3,3	8000	350	
EAMM-A-R38-70A	ELGG, ELGR	4,4	3,2	8000	350	
EAMM-A-R38-87A	ELGG, ELGR	4,4	3,2	8000	530	
EAMM-A-R48-70A	ELGG, ELGR	12,5	14,5	8000	450	
EAMM-A-R48-80P	ELGG, ELGR	17	39	6000	710	
EAMM-A-R48-87A	ELGG, ELGR	12,5	14,5	8000	590	
EAMM-A-R48-100A	ELGG, ELGR	17	39	6000	970	



# Axiální sady EAMM-A

technické údaje

FESTO

Provozní a okolní podmínky		
teplota okolí	[°C]	-10 ... +60
skladovací teplota	[°C]	-25 ... +60
stupeň krytí <sup>1)</sup>		
EAMM-A-...		IP40
EAMM-A-...-S1		IP65
relativní vlhkost vzduchu	[%]	0 ... 95
odolnost korozi KBK <sup>2)</sup>		1
upozornění k materiálu		odpovídá RoHS

1) pouze v kombinaci s namontovaným motorem a namontovaným pohonem

2) Třída odolnosti korozi 1 dle normy Festo 940 070:  
konstrukční díly s nižšími nároky na odolnost korozi. Ochrana při přepravě a skladování. Díly bez provoďých požadavků na vzhled povrchu, např. ve vnitřním prostoru nebo pod krytem.

# Axiální sady EAMM-A

technické údaje

FESTO

Rozměry a údaje pro objednávky

modely CAD ke stažení → [www.festo.com](http://www.festo.com)

DGE-ZR-...

EAMM-A-G-...

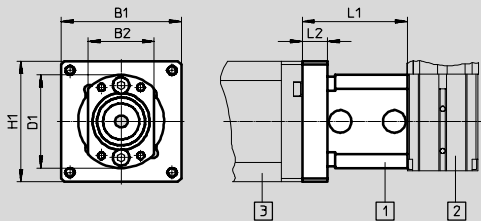

EAMM-A-F-...

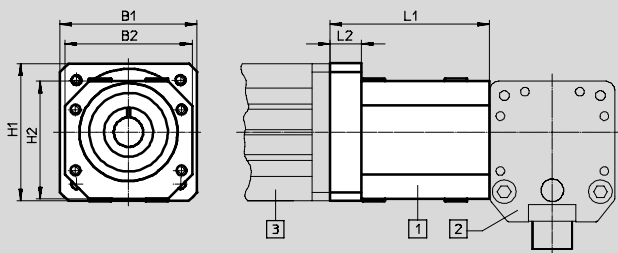

Schématický náčrtek:

- 1 axiální sada
- 2 pohon s ozubeným řemenem
- 3 motor

typ	B1	B2	H1	H2	L1	L2
EAMM-A-F30-55A	55	45	55	45	51,4	10,5
EAMM-A-F30-57A	56,4	45	56,4	45	52,7	12
EAMM-A-F30-70A	70	45	70	45	54,2	13,5
EAMM-A-F30-87A	85,8	45	85,8	45	56,2	15,5
EAMM-A-F30-60G	60	45	60	45	60,7	20
EAMM-A-F37-55A	55	45	55	45	51,4	15
EAMM-A-F37-57A	56,4	45	56,4	45	52,7	10
EAMM-A-F37-70A	70	45	70	45	54,2	14,5
EAMM-A-F37-87A	85,8	45	85,8	45	56,2	19
EAMM-A-F37-60G	60	45	60	45	60,7	11,5
EAMM-A-F40-70A	70	65	70	60	81,2	16
EAMM-A-F40-87A	85,8	65	85,8	60	82,7	17,5
EAMM-A-F40-100A	100	65	100	60	86,2	21
EAMM-A-F40-80G	90	65	90	60	89,4	24
EAMM-A-F47-87A	85,8	65	85,8	60	82,7	12,5
EAMM-A-F47-100A	100	65	100	60	86,2	5
EAMM-A-F47-140A	138	65	138	60	95,2	10,5
EAMM-A-F47-80G	90	65	90	60	89,4	8,3

## Axiální sady EAMM-A

technické údaje



FESTO

typ	B1	B2	D1	H1	H2	L1	L2
EAMM-A-F62-100A	100	100	–	105	100	116,2	25
EAMM-A-F62-140A	138	100	–	138	100	111,2	20
EAMM-A-F62-80G	115	100	–	115	100	119,2	28
EAMM-A-F62-120G	115	100	–	115	100	119,2	28
EAMM-A-F80-100A	100	100	–	105	100	116,2	21
EAMM-A-F80-140A	138	100	–	138	100	111,2	12
EAMM-A-F80-80G	115	100	–	115	100	119,2	12
EAMM-A-F80-120G	115	100	–	115	100	119,2	10,5
EAMM-A-F80-160G	160	100	–	160	100	151,2	21
EAMM-A-G13-40A	40	22	29	40	–	33,9	8,3
EAMM-A-G13-42A	42	22	29	42	–	42,2	16,5
EAMM-A-G16-40A	40	22	31	40	–	34,9	8,3
EAMM-A-G16-42A	42	22	31	42	–	42,4	18
EAMM-A-G16-55A	55	22	31	55	–	37,7	11
EAMM-A-G19-40A	48	31	44,5	48	–	38,5	9,5
EAMM-A-G19-55A	55	31	44,5	55	–	39,7	10,5
EAMM-A-G19-57A	56,4	31	44,5	56,4	–	41	12

# Axiální sady EAMM-A

technické údaje

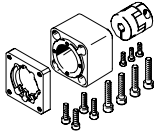

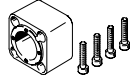
FESTO

Jednotlivé díly – údaje pro objednávky			
axiální sada	součásti:		
	příruba motoru	spojka	spojková skříň
			
č. dílu typ	č. dílu typ	č. dílu typ	č. dílu typ
550929 EAMM-A-F30-55A	529942 EAMF-A-44A/B-55A	557390 EAMC-30-35-8-9	124628 EAMK-A-F30-44A
550930 EAMM-A-F30-57A	530081 EAMF-A-44A/B-57A	530088 EAMC-30-35-6,35-8	124628 EAMK-A-F30-44A
550932 EAMM-A-F30-70A	529943 EAMF-A-44A/B-70A	123042 EAMC-30-35-8-11	124628 EAMK-A-F30-44A
550933 EAMM-A-F30-87A	530082 EAMF-A-44A/B-87A	123042 EAMC-30-35-8-11	124628 EAMK-A-F30-44A
550931 EAMM-A-F30-60G	529944 EAMF-A-44A/B-60G	123042 EAMC-30-35-8-11	124628 EAMK-A-F30-44A
550942 EAMM-A-F37-55A	529942 EAMF-A-44A/B-55A	557390 EAMC-30-35-8-9	534394 EAMK-A-F37-44A/C
550943 EAMM-A-F37-57A	530081 EAMF-A-44A/B-57A	530088 EAMC-30-35-6,35-8	534394 EAMK-A-F37-44A/C
550945 EAMM-A-F37-70A	529943 EAMF-A-44A/B-70A	123042 EAMC-30-35-8-11	534394 EAMK-A-F37-44A/C
550946 EAMM-A-F37-87A	530082 EAMF-A-44A/B-87A	123042 EAMC-30-35-8-11	534394 EAMK-A-F37-44A/C
550944 EAMM-A-F37-60G	529944 EAMF-A-44A/B-60G	123042 EAMC-30-35-8-11	534394 EAMK-A-F37-44A/C
550934 EAMM-A-F40-70A	529945 EAMF-A-64A/B-70A	550998 EAMC-40-66-11-15	124629 EAMK-A-F40-64A
550936 EAMM-A-F40-87A	533140 EAMF-A-64A/B-87A	550998 EAMC-40-66-11-15	124629 EAMK-A-F40-64A
550937 EAMM-A-F40-100A	529947 EAMF-A-64A/C/D-100A	123844 EAMC-40-66-15-19	124629 EAMK-A-F40-64A
550935 EAMM-A-F40-80G	533139 EAMF-A-64A/C-80G	123845 EAMC-40-66-15-20	124629 EAMK-A-F40-64A
550948 EAMM-A-F47-87A	533140 EAMF-A-64A/B-87A	550998 EAMC-40-66-11-15	534395 EAMK-A-F47-64A
550949 EAMM-A-F47-100A	529947 EAMF-A-64A/C/D-100A	123844 EAMC-40-66-15-19	534395 EAMK-A-F47-64A
550950 EAMM-A-F47-140A	550988 EAMF-A-64A-140A	176033 EAMC-40-66-15-24	534395 EAMK-A-F47-64A
550947 EAMM-A-F47-80G	533139 EAMF-A-64A/C-80G	123845 EAMC-40-66-15-20	534395 EAMK-A-F47-64A

# Axiální sady EAMM-A

technické údaje

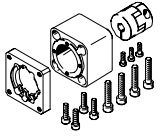
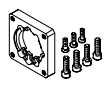
FESTO

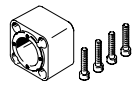
Jednotlivé díly			
axiální sada	součásti:		
	příruba motoru	spojka	spojková skříň
			
č. dílu typ	č. dílu typ	č. dílu typ	č. dílu typ
550939 EAMM-A-F62-100A	529949 EAMF-A-118C-100A	551000 EAMC-65-90-19-25	124630 EAMK-A-F62-118A/B/C
550941 EAMM-A-F62-140A	550991 EAMF-A-118B-140A	123852 EAMC-65-90-24-25	124630 EAMK-A-F62-118A/B/C
550938 EAMM-A-F62-80G	550989 EAMF-A-118A-80G	176035 EAMC-65-90-20-25	124630 EAMK-A-F62-118A/B/C
550940 EAMM-A-F62-120G	550990 EAMF-A-118A-120G	123853 EAMC-65-90-25-25	124630 EAMK-A-F62-118A/B/C
550952 EAMM-A-F80-100A	529949 EAMF-A-118C-100A	551000 EAMC-65-90-19-25	534396 EAMK-A-F80-118A/B/C
550954 EAMM-A-F80-140A	550991 EAMF-A-118B-140A	123852 EAMC-65-90-24-25	534396 EAMK-A-F80-118A/B/C
550951 EAMM-A-F80-80G	550989 EAMF-A-118A-80G	176035 EAMC-65-90-20-25	534396 EAMK-A-F80-118A/B/C
550953 EAMM-A-F80-120G	550990 EAMF-A-118A-120G	123853 EAMC-65-90-25-25	534396 EAMK-A-F80-118A/B/C
550955 EAMM-A-F80-160G	550992 EAMF-A-118A-160G	551001 EAMC-65-90-25-40	534396 EAMK-A-F80-118A/B/C
550921 EAMM-A-G13-40A	540301 EAMF-A-28A/30A-40A	540750 EAMC-B-15-22-4-6	171186 EAMK-A-G13-28A
550922 EAMM-A-G13-42A	530080 EAMF-A-28A-42A	530084 EAMC-B-15-22-4-5	171186 EAMK-A-G13-28A
550923 EAMM-A-G16-40A	540301 EAMF-A-28A/30A-40A	540750 EAMC-B-15-22-4-6	171185 EAMK-A-G16-30A
550924 EAMM-A-G16-42A	530079 EAMF-A-30A-42A	530084 EAMC-B-15-22-4-5	171185 EAMK-A-G16-30A
550925 EAMM-A-G16-55A	534807 EAMF-A-30A-55A	184262 EAMC-B-15-22-4-9	171185 EAMK-A-G16-30A
550926 EAMM-A-G19-40A	550985 EAMF-A-44A/B-40A	184265 EAMC-B-19-24-6-6	170375 EAMK-A-G19-44B
550927 EAMM-A-G19-55A	529942 EAMF-A-44A/B-55A	184263 EAMC-B-19-24-6-9	170375 EAMK-A-G19-44B
550928 EAMM-A-G19-57A	530081 EAMF-A-44A/B-57A	530086 EAMC-B-19-24-6-6,35	170375 EAMK-A-G19-44B

# Axiální sady EAMM-A

technické údaje

FESTO

## Rozměry a údaje pro objednávku

modely CAD ke stažení → [www.festo.com](http://www.festo.com)

DGE-SP-...

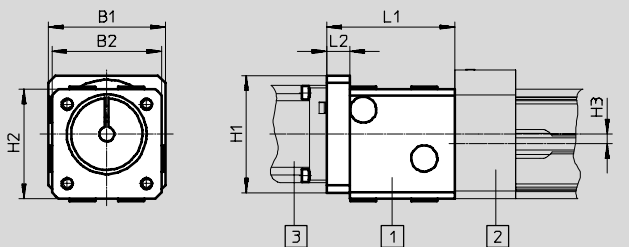

Schématický náčrt:

- 1 axiální sada
- 2 pohon s vřetenem
- 3 motor

DMES-...

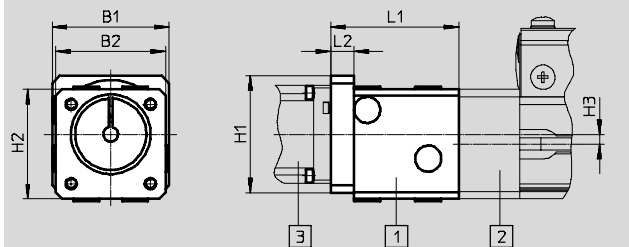

Schématický náčrt:



- 1 axiální sada
- 2 polohovací pohon
- 3 motor

typ	B1	B2	H1	H2	H3	L1	L2
EAMM-A-E20-32B	–	33,6	–	41	–	27 <sup>-0,2</sup>	7
EAMM-A-E20-40A	40	33,5	40	31,5	–	27,5	8,3
EAMM-A-E20-42A	42	33,5	42	31,5	–	35,7	5
EAMM-A-E20-55A	55	33,5	55	31,5	–	29,5	10,5
EAMM-A-E32-40A	48	45	48	45	4	52,5	9,5
EAMM-A-E32-42B	–	44,8	–	54,4	4	88	23
EAMM-A-E32-42C	–	44,8	–	54,4	4	101	36
EAMM-A-E32-55A	55	45	55	45	4	53,7	10,5
EAMM-A-E32-57A	56,4	45	56,4	45	4	55	12
EAMM-A-E48-52B	–	63,8	–	76,4	5	121	25
EAMM-A-E48-52C	–	63,8	–	76,4	5	135	39
EAMM-A-E48-55A	55	64 <sup>-0,3</sup>	55	64 <sup>-0,3</sup>	5	57,2	10,5
EAMM-A-E48-57A	56,4	64 <sup>-0,3</sup>	56,4	64 <sup>-0,3</sup>	5	58,5	12
EAMM-A-E48-44A-70A	70	64 <sup>-0,3</sup>	70	64 <sup>-0,3</sup>	5	60	13,5
EAMM-A-E48-64A-70A	70	65 <sup>-0,3</sup>	70	64 <sup>-0,3</sup>	5	86,2	16
EAMM-A-E48-87A	85,8	65 <sup>-0,3</sup>	85,8	64 <sup>-0,3</sup>	5	87,7	17,5
EAMM-A-E48-100A	100	65 <sup>-0,3</sup>	100	64 <sup>-0,3</sup>	5	91,2	21
EAMM-A-E48-40G	50	64 <sup>-0,3</sup>	50	64 <sup>-0,3</sup>	5	63,5	17
EAMM-A-E72-62B	–	105,1	–	127,3	8	150	34
EAMM-A-E72-70A	70	105,6	70	114,8	8	98,7	16
EAMM-A-E72-87A	85,8	105,6	85,8	114,8	8	100,2	17,5
EAMM-A-E72-100A	100	105,6	100	114,8	8	103,7	21
EAMM-A-E72-60G	70	105,6	70	114,8	8	106,9	24,4
EAMM-A-E72-80G	90	105,6	90	114,8	8	106,9	24

# Axiální sady EAMM-A

technické údaje

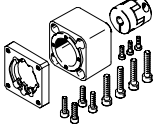
FESTO

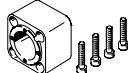
Jednotlivé díly			
axiální sada	součásti:		
	příruba motoru	spojka	spojková skříň
			
č. dílu typ	č. dílu typ	č. dílu typ	č. dílu typ
556991 EAMM-A-E20-32B	–	533707 EAMC-15-20-5-6	533703 EAMK-A-E20-32B
550961 EAMM-A-E20-40A	552163 EAMF-A-28B-40A	540751 EAMC-B-15-22-5-6	170374 EAMK-A-E20-28B
550962 EAMM-A-E20-42A	552164 EAMF-A-28B-42A	530085 EAMC-B-15-22-5-5	170374 EAMK-A-E20-28B
550963 EAMM-A-E20-55A	529946 EAMF-A-28A/B-55A	529953 EAMC-B-15-22-5-9	170374 EAMK-A-E20-28B
550964 EAMM-A-E32-40A	550985 EAMF-A-44A/B-40A	123040 EAMC-30-35-6-6	124631 EAMK-A-E32-44A
556992 EAMM-A-E32-42B	–	533708 EAMC-30-32-6-8	533704 EAMK-A-E32-42B
556993 EAMM-A-E32-42C	–	533708 EAMC-30-32-6-8	538578 EAMK-A-E32-42C
550965 EAMM-A-E32-55A	529942 EAMF-A-44A/B-55A	530941 EAMC-30-35-6-9	124631 EAMK-A-E32-44A
550966 EAMM-A-E32-57A	530081 EAMF-A-44A/B-57A	530087 EAMC-30-35-6-6,35	124631 EAMK-A-E32-44A
556994 EAMM-A-E48-52B	–	533709 EAMC-42-50-12-12	533705 EAMK-A-E48-52B
556995 EAMM-A-E48-52C	–	533709 EAMC-42-50-12-12	538579 EAMK-A-E48-52C
550969 EAMM-A-E48-55A	529942 EAMF-A-44A/B-55A	550996 EAMC-30-35-9-12	124632 EAMK-A-E48-44A
550970 EAMM-A-E48-57A	530081 EAMF-A-44A/B-57A	550995 EAMC-30-35-6,35-12	124632 EAMK-A-E48-44A
550971 EAMM-A-E48-44A-70A	529943 EAMF-A-44A/B-70A	123051 EAMC-30-35-11-12	124632 EAMK-A-E48-44A
557448 EAMM-A-E48-64A-70A	529945 EAMF-A-64A/B-70A	525864 EAMC-40-66-11-12	529940 EAMK-A-E48-64A
550972 EAMM-A-E48-87A	533140 EAMF-A-64A/B-87A	525864 EAMC-40-66-11-12	529940 EAMK-A-E48-64A
550973 EAMM-A-E48-100A	529947 EAMF-A-64A/C/D-100A	529952 EAMC-40-66-12-19	529940 EAMK-A-E48-64A
550968 EAMM-A-E48-40G	550986 EAMF-A-44A/B-40G	552640 EAMC-30-35-10-12	124632 EAMK-A-E48-44A
556996 EAMM-A-E72-62B	–	533710 EAMC-42-50-14-20	533706 EAMK-A-E72-62B
550975 EAMM-A-E72-70A	529945 EAMF-A-64A/B-70A	550999 EAMC-40-66-11-20	529941 EAMK-A-E72-64A
550977 EAMM-A-E72-87A	533140 EAMF-A-64A/B-87A	550999 EAMC-40-66-11-20	529941 EAMK-A-E72-64A
550978 EAMM-A-E72-100A	529947 EAMF-A-64A/C/D-100A	123847 EAMC-40-66-19-20	529941 EAMK-A-E72-64A
550974 EAMM-A-E72-60G	550987 EAMF-A-64A/B-60G/H	550999 EAMC-40-66-11-20	529941 EAMK-A-E72-64A
550976 EAMM-A-E72-80G	533139 EAMF-A-64A/C-80G	123849 EAMC-40-66-20-20	529941 EAMK-A-E72-64A

# Axiální sady EAMM-A

technické údaje

FESTO

## Rozměry a údaje pro objednávky

modely CAD ke stažení → [www.festo.com](http://www.festo.com)

EGSL-...

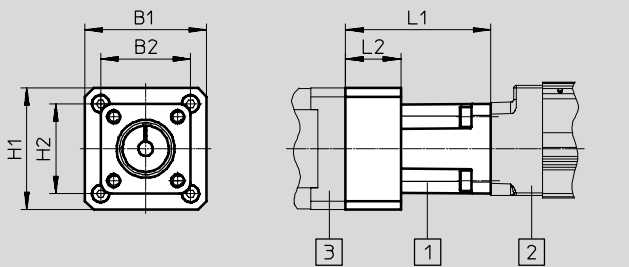

Schématický náčrt:

- 1 axiální sada
- 2 saně Mini
- 3 motor

DNCE-... se stupněm krytí IP40

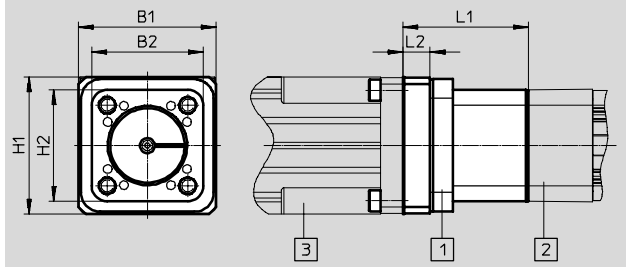

Schématický náčrt:

- 1 axiální sada
- 2 elektrický válec
- 3 motor

ESBF-... se stupněm krytí IP40

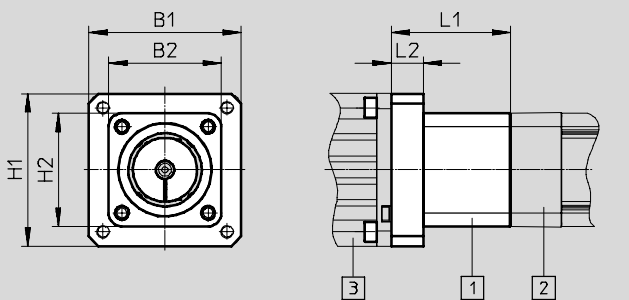

Schématický náčrt:

- 1 axiální sada
- 2 elektrický válec
- 3 motor

ERMB-...

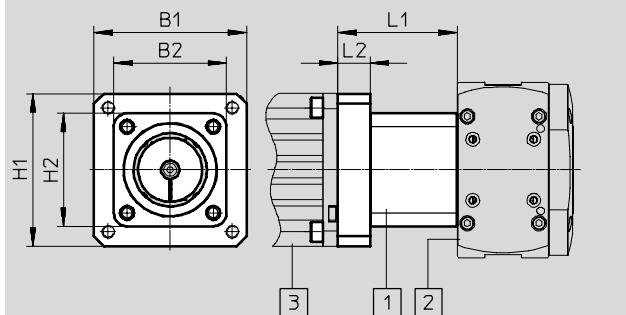

Schématický náčrt:

- 1 axiální sada
- 2 otočný modul
- 3 motor

EHMB-...

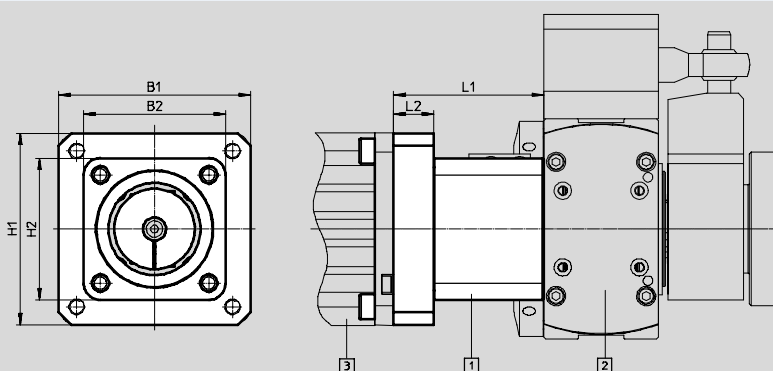

Schématický náčrt:

- 1 axiální sada
- 2 kyvně přímočarý modul
- 3 motor



## Axiální sady EAMM-A

technické údaje



FESTO

typ	B1	B2	H1	H2	L1	L2
EAMM-A-D19-28A	30	31	30	31	46,2	15
EAMM-A-D19-40A	40	31	40	31	42,7	11,5
EAMM-A-D19-40P	39,7	31	39,7	31	45,7	14,5
EAMM-A-D19-42A	42	31	42	31	50	19
EAMM-A-D32-32B	33,6	45	41	45	43	–
EAMM-A-D32-35A-40A	35	31	35	31	41,2	10
EAMM-A-D32-35A-40P	40	31	40	31	42,7	11,5
EAMM-A-D32-40A	40	45	40	45	39,8	8,3
EAMM-A-D32-40P	39,7	45	39,7	45	44	12,5
EAMM-A-D32-42A	42	45	42	45	48	5
EAMM-A-D32-55A	55	45	55	45	49,2	10,5
EAMM-A-D32-57A	56,4	65	56,4	45	50,5	12
EAMM-A-D32-60P	61,4	65	61,4	45	59,7	21
EAMM-A-D40-40G	50	53,5	50	53,5	55,5	17
EAMM-A-D40-42B	44,8	53,5	54,4	53,5	88	9
EAMM-A-D40-42C	44,8	53,5	54,4	53,5	101	9
EAMM-A-D40-55A	55	53,5	55	53,5	49,2	10,5
EAMM-A-D40-57A	56,4	53,5	56,4	53,5	50,5	12
EAMM-A-D40-60P	61,4	53,5	61,4	53,5	59,7	21
EAMM-A-D40-70A	70	53,5	70	53,5	52	13,5
EAMM-A-D40-87A	85,8	53,5	85,8	53,5	54	15,5
EAMM-A-D60-52B	63,8	74	76,4	74	112	13
EAMM-A-D60-52C	63,8	74	76,4	74	126	13
EAMM-A-D60-60G	70	74	70	74	71,4	24
EAMM-A-D60-70A	70	74	70	74	63,2	16
EAMM-A-D60-80P	81,3	74	81,3	74	74,7	17,5
EAMM-A-D60-87A	85,8	74	85,8	74	64,7	17,5
EAMM-A-D60-100A	100	74	100	74	78,2	21
EAMM-A-D80-100A	100	97,2	100	97,2	92	20
EAMM-A-D80-140A	140,5	97,2	140,5	97,2	102	30
EAMM-A-D100-140A	140,5	109	140,5	109	109,5	30

# Axiální sady EAMM-A

technické údaje

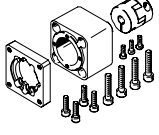
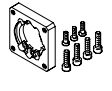

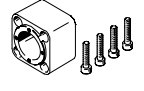
FESTO

Jednotlivé díly			
axiální sada	součásti:		
	příruba motoru	spojka	spojková skříň
			
č. dílu typ	č. dílu typ	č. dílu typ	č. dílu typ
1081659 EAMM-A-D19-28A	1087613 EAMF-A-28D-28A	562676 EAMC-16-20-5-5	1087585 EAMK-A-D19-28D
1199152 EAMM-A-D19-40A	1199144 EAMF-A-28D-40A	543419 EAMC-16-20-5-6	1087585 EAMK-A-D19-28D
1981953 EAMM-A-D19-40P	1982014 EAMF-A-28D-40P	562677 EAMC-16-20-5-8	1087585 EAMK-A-D19-28D
1087642 EAMM-A-D19-42A	1087630 EAMF-A-28D-42A	562676 EAMC-16-20-5-5	1087585 EAMK-A-D19-28D
543149 EAMM-A-D32-32B	–	543420 EAMC-16-20-6-6	552156 EAMK-A-D32-32B
560281 EAMM-A-D32-35A-40A	–	558312 EAMC-30-32-6-6	560280 EAMK-A-D32-35-40A
2207441 EAMM-A-D32-35A-40P	–	533708 EAMC-30-32-6-8	2207509 EAMK-A-D32-35A-40P
543147 EAMM-A-D32-40A	552163 EAMF-A-28B-40A	543420 EAMC-16-20-6-6	552155 EAMK-A-D32-28B
1976465 EAMM-A-D32-40P	1976704 EAMF-A-28B-40P	1232854 EAMC-16-20-6-8	552155 EAMK-A-D32-28B
543148 EAMM-A-D32-42A	552164 EAMF-A-28B-42A	543419 EAMC-16-20-5-6	552155 EAMK-A-D32-28B
550979 EAMM-A-D32-55A	529942 EAMF-A-44A/B-55A	551003 EAMC-30-32-6-9	551006 EAMK-A-D32-44A/C
550980 EAMM-A-D32-57A	530081 EAMF-A-44A/B-57A	551002 EAMC-30-32-6-6,35	551006 EAMK-A-D32-44A/C
1956054 EAMM-A-D32-60P	1956846 EAMF-A-44C-60P	1233256 EAMC-30-32-6-14	551006 EAMK-A-D32-44A/C

# Axiální sady EAMM-A

technické údaje

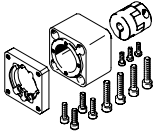
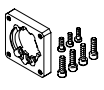
FESTO

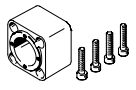
Jednotlivé díly			
axiální sada	součásti:		
	příruba motoru	spojka	spojková skříň
			
č. dílu typ	č. dílu typ	č. dílu typ	č. dílu typ
560282 EAMM-A-D40-40G	550986 EAMF-A-44A/B-40G	558029 EAMC-30-32-8-10	552157 EAMK-A-D40-44A/C
543155 EAMM-A-D40-42B	–	543422 EAMC-30-32-8-8	522158 EAMK-A-D40-42B
543156 EAMM-A-D40-42C	–	543422 EAMC-30-32-8-8	522159 EAMK-A-D40-42C
543153 EAMM-A-D40-55A	529942 EAMF-A-44A/B-55A	543423 EAMC-30-32-8-9	552157 EAMK-A-D40-44A/C
543154 EAMM-A-D40-57A	530081 EAMF-A-44A/B-57A	543421 EAMC-30-32-6,35-8	552157 EAMK-A-D40-44A/C
1977000 EAMM-A-D40-60P	1956846 EAMF-A-44C-60P	562682 EAMC-30-32-8-14	552157 EAMK-A-D40-44A/C
550981 EAMM-A-D40-70A	529943 EAMF-A-44A/B-70A	551004 EAMC-30-32-8-11	552157 EAMK-A-D40-44A/C
550982 EAMM-A-D40-87A	530082 EAMF-A-44A/B-87A	551004 EAMC-30-32-8-11	552157 EAMK-A-D40-44A/C
543163 EAMM-A-D60-52B	–	533709 EAMC-42-50-12-12	552161 EAMK-A-D60-52B
543164 EAMM-A-D60-52C	–	533709 EAMC-42-50-12-12	552162 EAMK-A-D60-52C
560283 EAMM-A-D60-60G	550987 EAMF-A-64A/B-60G/H	543424 EAMC-42-50-11-12	552160 EAMK-A-D60-64B
543161 EAMM-A-D60-70A	529945 EAMF-A-64A/B-70A	543424 EAMC-42-50-11-12	552160 EAMK-A-D60-64B
1977073 EAMM-A-D60-80P	1977113 EAMF-A-64A/C-80P	551005 EAMC-42-50-12-19	551007 EAMK-A-D60-64C
543162 EAMM-A-D60-87A	533140 EAMF-A-64A/B-87A	543424 EAMC-42-50-11-12	552160 EAMK-A-D60-64B
550983 EAMM-A-D60-100A	529947 EAMF-A-64A/C/D-100A	551005 EAMC-42-50-12-19	551007 EAMK-A-D60-64C
1589665 EAMM-A-D80-100A	1593628 EAMF-A-77A-100A	1485673 EAMC-56-58-19-19	1593627 EAMK-A-D80-77A
1588299 EAMM-A-D80-140A	1593636 EAMF-A-77A-140A	1485674 EAMC-56-58-19-24	1593627 EAMK-A-D80-77A
1588349 EAMM-A-D100-140A	1593636 EAMF-A-77A-140A	1451407 EAMC-67-62-24-24	1593914 EAMK-A-D100-77A/B

# Axiální sady EAMM-A

technické údaje

FESTO

## Rozměry a údaje pro objednávky

DNCE... se stupněm krytí IP65

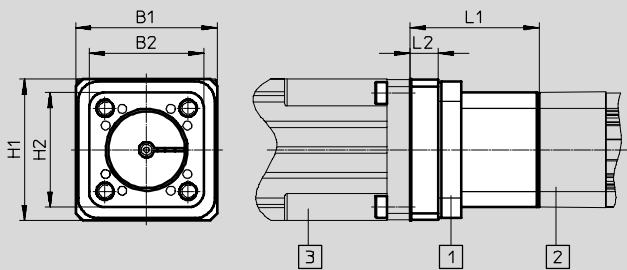

Schématický náčrt:

- 1 axiální sada
- 2 elektrický válec
- 3 motor

modely CAD ke stažení → [www.festo.com](http://www.festo.com)

ESBF... se stupněm krytí IP65

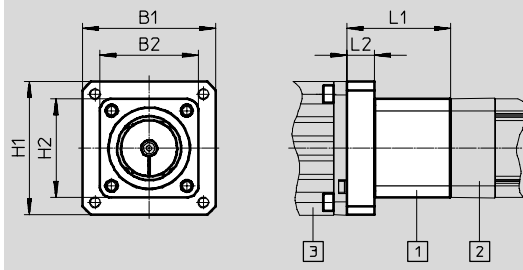

Schématický náčrt:



- 1 axiální sada
- 2 elektrický válec
- 3 motor

typ	B1	B2	H1	H2	L1	L2
EAMM-A-D32-40P-S1	39,7	45	39,7	45	45,5	13
EAMM-A-D32-40A-S1	40	45	40	45	41,3	8,8
EAMM-A-D32-42A-S1	42	45	42	45	49,5	5,5
EAMM-A-D32-55A-S1	55	45	55	45	50,7	11
EAMM-A-D32-57A-S1	56,4	45	56,4	45	52	12,5
EAMM-A-D32-60P-S1	61,4	45	61,4	45	60,7	21
EAMM-A-D40-55A-S1	55	53,5	55	53,5	50,7	11
EAMM-A-D40-57A-S1	56,4	53,5	56,4	53,5	52	12,5
EAMM-A-D40-60P-S1	61,4	53,5	61,4	53,5	61,2	22
EAMM-A-D40-70A-S1	70	53,5	70	53,5	53,5	14
EAMM-A-D40-87A-S1	85,8	53,5	85,8	53,5	55,5	16
EAMM-A-D60-80P-S1	81,3	74	81,3	74	75,7	18
EAMM-A-D60A-70A-S1	70	74	70	74	65	16,5
EAMM-A-D60-87A-S1	85,8	74	85,8	74	66,5	18
EAMM-A-D60A-100A-S1	100	74	100	74	80	21,5
EAMM-A-D60B-70A-S1	70	74	70	74	65	16,5
EAMM-A-D60B-100A-S1	100	74	100	74	80	21,5
EAMM-A-D80-100A-S1	100	97,2	100	97,2	93,5	20,5
EAMM-A-D80-140A-S1	140,5	97,2	140,5	97,2	103,5	30,5
EAMM-A-D100-140A-S1	140,5	109	140,5	109	111	30,5

# Axiální sady EAMM-A

technické údaje

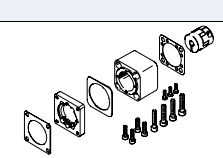
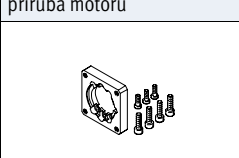
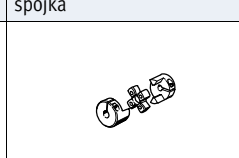
FESTO

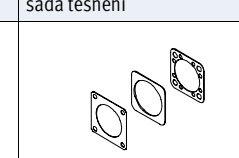
Jednotlivé díly axiální sada	součásti:			
	příruba motoru	spojka	spojková skříň	sada těsnění
				
č. dílu typ	č. dílu typ	č. dílu typ	č. dílu typ	č. dílu typ
2207372 EAMM-A-D32-40P-S1	1976704 EAMF-A-28B-40P	1232854 EAMC-16-20-6-8	552155 EAMK-A-D32-28B	2207219 EADS-F-D32-40P
1322178 EAMM-A-D32-40A-S1	552163 EAMF-A-28B-40A	543420 EAMC-16-20-6-6	552155 EAMK-A-D32-28B	1561526 EADS-F-D32-40A
1322179 EAMM-A-D32-42A-S1	552164 EAMF-A-28B-42A	543419 EAMC-16-20-5-6	552155 EAMK-A-D32-28B	1561527 EADS-F-D32-42A
1322180 EAMM-A-D32-55A-S1	529942 EAMF-A-44A/B-55A	551003 EAMC-30-32-6-9	551006 EAMK-A-D32-44A/C	1561528 EADS-F-D32-55A
1322181 EAMM-A-D32-57A-S1	530081 EAMF-A-44A/B-57A	551002 EAMC-30-32-6-6,35	551006 EAMK-A-D32-44A/C	1561529 EADS-F-D32-57A
2234020 EAMM-A-D32-60P-S1	1956846 EAMF-A-44C-60P	1233256 EAMC-30-32-6-14	551006 EAMK-A-D32-44A/C	2234012 EADS-F-D32-60P
1322182 EAMM-A-D40-55A-S1	529942 EAMF-A-44A/B-55A	543423 EAMC-30-32-8-9	552157 EAMK-A-D40-44A/C	1561530 EADS-F-D40-55A
1322183 EAMM-A-D40-57A-S1	530081 EAMF-A-44A/B-57A	543421 EAMC-30-32-6,35-8	552157 EAMK-A-D40-44A/C	1561531 EADS-F-D40-57A
2151519 EAMM-A-D40-60P-S1	1956846 EAMF-A-44C-60P	562682 EAMC-30-32-8-14	552157 EAMK-A-D40-44A/C	2151545 EADS-F-D40-60P
1322185 EAMM-A-D40-70A-S1	529943 EAMF-A-44A/B-70A	551004 EAMC-30-32-8-11	552157 EAMK-A-D40-44A/C	1561532 EADS-F-D40-70A
1322186 EAMM-A-D40-87A-S1	530082 EAMF-A-44A/B-87A	551004 EAMC-30-32-8-11	552157 EAMK-A-D40-44A/C	1561533 EADS-F-D40-87A
2218564 EAMM-A-D60-80P-S1	1977113 EAMF-A-64A/C-80P	551005 EAMC-42-50-12-19	551007 EAMK-A-D60-64C	2218523 EADS-F-D60-80P
1322187 EAMM-A-D60A-70A-S1	529945 EAMF-A-64A/B-70A	543424 EAMC-42-50-11-12	552160 EAMK-A-D60-64B	1561534 EADS-F-D60A-70A
1322188 EAMM-A-D60-87A-S1	533140 EAMF-A-64A/B-87A	543424 EAMC-42-50-11-12	552160 EAMK-A-D60-64B	1561536 EADS-F-D60-87A
1322190 EAMM-A-D60A-100A-S1	529947 EAMF-A-64A/C/D-100A	551005 EAMC-42-50-12-19	551007 EAMK-A-D60-64C	1561537 EADS-F-D60A-100A
1679566 EAMM-A-D60B-70A-S1	529945 EAMF-A-64A/B-70A	543424 EAMC-42-50-11-12	552160 EAMK-A-D60-64B	1679570 EADS-F-D60B-70A
1679518 EAMM-A-D60B-100A-S1	529947 EAMF-A-64A/C/D-100A	551005 EAMC-42-50-12-19	551007 EAMK-A-D60-64C	1679522 EADS-F-D60B-100A
1600673 EAMM-A-D80-100A-S1	1593628 EAMF-A-77A-100A	1485673 EAMC-56-58-19-19	1593627 EAMK-A-D80-77A	1593617 EADS-F-D80-100A
1600674 EAMM-A-D80-140A-S1	1593636 EAMF-A-77A-140A	1485674 EAMC-56-58-19-24	1593627 EAMK-A-D80-77A	1593671 EADS-F-D80-140A
1600675 EAMM-A-D100-140A-S1	1593636 EAMF-A-77A-140A	1451407 EAMC-67-62-24-24	1593914 EAMK-A-D100-77A/B	1593991 EADS-F-D100-140A

# Axiální sady EAMM-A

technické údaje

FESTO

Rozměry a údaje pro objednávky

modely CAD ke stažení → [www.festo.com](http://www.festo.com)

EGC-TB-...

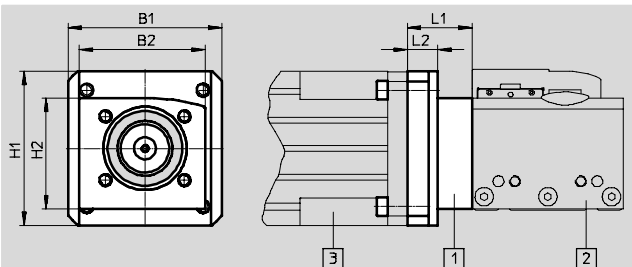

Schématický náčrt:

- 1 axiální sada
- 2 pohon s ozubeným řemenem
- 3 motor





typ	B1	B2	H1	H2	L1	L2
EAMM-A-L27-55A	55	40	55	55	23,1	–
EAMM-A-L27-57A	56	39,5	56	56	23,1	–
EAMM-A-L27-40G	50	40	50	50	28,7	–
EAMM-A-L38-57A	56	57,5	56	50,3	26,7	11
EAMM-A-L38-60G	60	57,5	60	50,3	41,7	26
EAMM-A-L38-60P	61,4	57,5	61,4	50,3	36,7	21
EAMM-A-L38-70A	70	57,5	70	50,3	29,5	13,8
EAMM-A-L38-87A	85,8	57,5	85,8	50,3	33,7	18
EAMM-A-L48-70A	70	65	70	61	40,2	12,2
EAMM-A-L48-80P	81,3	65	81,3	61	54	26
EAMM-A-L48-87A	85,8	65	85,8	61	44	16
EAMM-A-L48-100A	100,5	65	100,5	61	59	31
EAMM-A-L48-60G	60	65	60	61	52,5	24,5
EAMM-A-L62-100A	100,5	100	100,5	90,5	62,5	14,5
EAMM-A-L62-140A	140	100	140	90,5	72,5	24,5
EAMM-A-L62-80G	100	100	100	90,5	62,5	14,5
EAMM-A-L95-140A	140	140	140	142,5	76	27
EAMM-A-L95-190A	190	140	190	142,5	86	37
EAMM-A-L95-120G	124	140	124	142,5	81	32

Jednotlivé díly				
axiální sada	součásti:			
	příruba motoru	spojka	spojková skříň	sada šroubů
č. dílu typ	č. dílu typ	č. dílu typ	č. dílu typ	č. dílu typ
557975 EAMM-A-L27-55A	558016 EAMF-A-L27-55A	557999 EAMD-19-15-9-8X10	–	–
560678 EAMM-A-L27-57A	560690 EAMF-A-L27-57A	561292 EAMD-16-15-6,35-8X10	–	–
557974 EAMM-A-L27-40G	558015 EAMF-A-L27-40G	557998 EAMD-19-15-10-8X10	–	–
560679 EAMM-A-L38-57A	560692 EAMF-A-38A-57A	561293 EAMD-25-22-6,35-10X12	558011 EAMK-A-L38-38A	567484 EAHM-L2-M5-30
557978 EAMM-A-L38-60G	558017 EAMF-A-38A-60G/H	558000 EAMD-25-22-11-10X12	558011 EAMK-A-L38-38A	567485 EAHM-L2-M5-35
2037246 EAMM-A-L38-60P	1987412 EAMF-A-38A-60P	1453861 EAMD-28-22-14-10X12	558011 EAMK-A-L38-38A	567485 EAHM-L2-M5-35
557979 EAMM-A-L38-70A	558018 EAMF-A-38A-70A	558000 EAMD-25-22-11-10X12	558011 EAMK-A-L38-38A	567484 EAHM-L2-M5-30
560680 EAMM-A-L38-87A	560693 EAMF-A-38A-87A	558000 EAMD-25-22-11-10X12	558011 EAMK-A-L38-38A	567485 EAHM-L2-M5-35

# Axiální sady EAMM-A

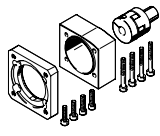
technické údaje

FESTO

Jednotlivé díly				
axiální sada	součásti:			
	příruba motoru	spojka	spojková skříň	sada šroubů
				
č. dílu typ	č. dílu typ	č. dílu typ	č. dílu typ	č. dílu typ
557982 EAMM-A-L48-70A	558025 EAMF-A-48A-70A	558001 EAMD-32-32-11-16X20	558012 EAMK-A-L48-48A	567486 EAHM-L2-M5-40
2042616 EAMM-A-L48-80P	2043427 EAMF-A-48A-80P	558002 EAMD-42-40-19-16X25	558012 EAMK-A-L48-48A	567489 EAHM-L2-M5-55
560683 EAMM-A-L48-87A	560695 EAMF-A-48A-87A	558001 EAMD-32-32-11-16X20	558012 EAMK-A-L48-48A	567487 EAHM-L2-M5-45
557984 EAMM-A-L48-100A	558020 EAMF-A-48A-100A	558002 EAMD-42-40-19-16X25	558012 EAMK-A-L48-48A	567489 EAHM-L2-M5-55
557983 EAMM-A-L48-60G	558019 EAMF-A-48A-60G/H	558001 EAMD-32-32-11-16X20	558012 EAMK-A-L48-48A	567486 EAHM-L2-M5-40
557988 EAMM-A-L62-100A	558026 EAMF-A-62A-100A	558003 EAMD-56-46-19-23X27	558013 EAMK-A-L62-62A	567491 EAHM-L2-M6-65
557990 EAMM-A-L62-140A	558022 EAMF-A-62A-140A	558005 EAMD-56-46-24-23X27	558013 EAMK-A-L62-62A	567493 EAHM-L2-M6-70
557989 EAMM-A-L62-80G	558021 EAMF-A-62A-80G	558004 EAMD-56-46-20-23X27	558013 EAMK-A-L62-62A	567492 EAHM-L2-M6-65-L
557994 EAMM-A-L95-140A	558023 EAMF-A-95A-140A	558008 EAMD-67-51-24-32X32-U	558014 EAMK-A-L95-95A	567497 EAHM-L2-M8-80
1378474 EAMM-A-L95-190A	1378473 EAMF-A-95A-190A	1379269 EAMD-67-51-32-32X32-U	558014 EAMK-A-L95-95A	567497 EAHM-L2-M8-80
557995 EAMM-A-L95-120G	558024 EAMF-A-95A-120G	558006 EAMD-67-51-25-32X32-U	558014 EAMK-A-L95-95A	567496 EAHM-L2-M8-70

# Axiální sady EAMM-A

technické údaje

FESTO

Rozměry a údaje pro objednávky

modely CAD ke stažení → [www.festo.com](http://www.festo.com)

EGC-BS...

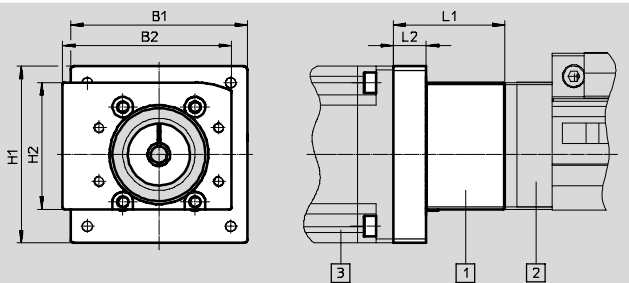

Schématický náčrt:

- 1 axiální sada
- 2 pohon s vřetenem
- 3 motor

typ	B1	B2	H1	H2	L1	L2
EAMM-A-S38-40A	58	69	44	50	44	7
EAMM-A-S38-40P	58	69	44	50	54	15,5
EAMM-A-S38-42A	58	69	44	50	52	15
EAMM-A-S38-55A	55	69	55	50	48	11
EAMM-A-S38-57A	56	69	56	50	48	11
EAMM-A-S38-60P	61,4	69	61,4	50	63,2	16
EAMM-A-S48-55A	70	82	55	61,5	47,2	9,2
EAMM-A-S48-57A	70	82	55	61,5	47,2	9,2
EAMM-A-S48-60P	61,4	82	61,4	61,5	74,7	17,5
EAMM-A-S48-70A	70	82	70	61,5	50,2	12,2
EAMM-A-S48-87A	85,8	82	85,8	61,5	54	16
EAMM-A-S62-70A	82	120	70	88,5	78,5	12
EAMM-A-S62-80P	81,3	120	81,3	88,5	64,7	17,5
EAMM-A-S62-87A	85,8	120	85,8	88,5	81,5	15
EAMM-A-S62-100A	100,5	120	100,5	88,5	81	14,5
EAMM-A-S62-140A	140	120	140	88,5	91	24,5
EAMM-A-S95-100A	140	186	100	140,5	85,5	17
EAMM-A-S95-140A	140	186	140	140,5	95,5	27





Jednotlivé díly				
axiální sada	součásti:			
	příruba motoru	spojka	spojková skříň	sada šroubů
č. dílu typ	č. dílu typ	č. dílu typ	č. dílu typ	č. dílu typ
558162 EAMM-A-S38-40A	558175 EAMF-A-38B-40A	558312 EAMC-30-32-6-6	558171 EAMK-A-S38-38A/B	-
2219044 EAMM-A-S38-40P	2219077 EAMF-A-38B-40P	533708 EAMC-30-32-6-8	558171 EAMK-A-S38-38A/B	-
560685 EAMM-A-S38-42A	560691 EAMF-A-38B-42A	561333 EAMC-30-32-5-6	558171 EAMK-A-S38-38A/B	-
558163 EAMM-A-S38-55A	558176 EAMF-A-38A-55A	551003 EAMC-30-32-6-9	558171 EAMK-A-S38-38A/B	567488 EAHM-L2-M5-50
560686 EAMM-A-S38-57A	560692 EAMF-A-38A-57A	551002 EAMC-30-32-6-6,35	558171 EAMK-A-S38-38A/B	567488 EAHM-L2-M5-50
2219110 EAMM-A-S38-60P	1987412 EAMM-A-38A-60P	1233256 EAMC-30-32-6-14	558171 EAMK-A-S38-38A/B	567489 EAHM-L2-M5-55
558164 EAMM-A-S48-55A	558177 EAMF-A-48B-55A	543423 EAMC-30-32-8-9	558172 EAMK-A-S48-48A/B	-
560687 EAMM-A-S48-57A	560694 EAMF-A-48B-57A	543421 EAMC-30-32-6,35-8	558172 EAMK-A-S48-48A/B	-
2220560 EAMM-A-S48-60P	2220620 EAMF-A-48A-60P	562682 EAMC-30-32-8-14	558172 EAMK-A-S48-48A/B	567489 EAHM-L2-M5-55
558165 EAMM-A-S48-70A	558025 EAMF-A-48A-70A	551004 EAMC-30-32-8-11	558172 EAMK-A-S48-48A/B	567488 EAHM-L2-M5-50
560688 EAMM-A-S48-87A	560695 EAMF-A-48A-87A	551004 EAMC-30-32-8-11	558172 EAMK-A-S48-48A/B	567489 EAHM-L2-M5-55

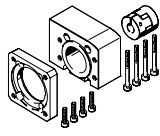

# Axiální sady EAMM-A

technické údaje

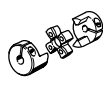
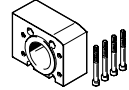
FESTO

Jednotlivé díly				
axiální sada	součásti:			
	příruba motoru	spojka	spojková skříň	sada šroubů
				
č. dílu typ	č. dílu typ	č. dílu typ	č. dílu typ	č. dílu typ
558166 EAMM-A-S62-70A	558179 EAMF-A-62B-70A	558313 EAMC-42-66-11-12	558173 EAMK-A-S62-62A/B	–
2222582 EAMM-A-S62-80P	2222624 EAMF-A-62B-80P	551005 EAMC-42-50-12-19	558173 EAMK-A-S62-62A/B	–
560689 EAMM-A-S62-87A	560696 EAMF-A-62B-87A	558313 EAMC-42-66-11-12	558173 EAMK-A-S62-62A/B	–
558167 EAMM-A-S62-100A	558026 EAMF-A-62A-100A	551005 EAMC-42-50-12-19	558173 EAMK-A-S62-62A/B	567494 EAHM-L2-M6-80
558168 EAMM-A-S62-140A	558022 EAMF-A-62A-140A	558314 EAMC-42-50-12-24	558173 EAMK-A-S62-62A/B	567495 EAHM-L2-M6-90
558169 EAMM-A-S95-100A	558182 EAMF-A-95B-100A	558315 EAMC-56-58-19-25	558174 EAMK-A-S95-95A/B	–
558170 EAMM-A-S95-140A	558023 EAMF-A-95A-140A	558316 EAMC-56-58-24-25	558174 EAMK-A-S95-95A/B	567498 EAHM-L2-M8-100

# Axiální sady EAMM-A

technické údaje

FESTO

Rozměry a údaje pro objednávky

modely CAD ke stažení → [www.festo.com](http://www.festo.com)

ELGA-...

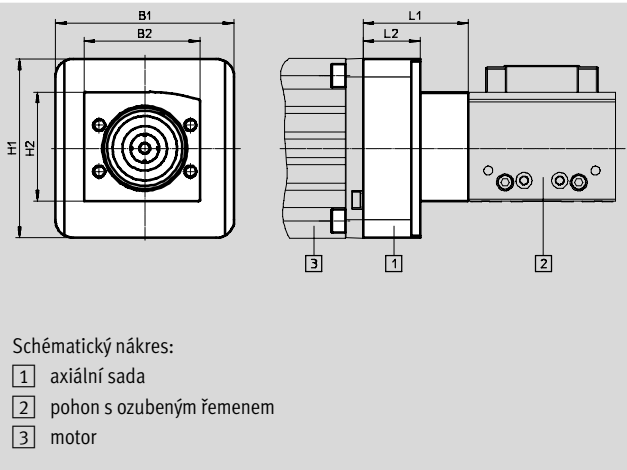

typ	B1	B2	H1	H2	L1	L2
EAMM-A-N38-70A	70	57,5	70	50,3	37,5	21
EAMM-A-N38-87A	85,5	57,5	85,5	50,3	42	25,5
EAMM-A-N38-60G	60	57,5	60	50,3	49,5	33
EAMM-A-N48-100A	100	65	100	61	59	31,9
EAMM-A-N48-60G	66	65	60	61	53,1	26
EAMM-A-N48-80G	100	65	100	61	59,1	32
EAMM-A-N80-80G	100	100	100	90,5	62,5	19
EAMM-A-N80-120G	124	100	124	90,5	77,5	34
EAMM-A-N80-140A	138	100	138	90,5	72,5	29

## Jednotlivé díly

axiální sada	součásti:			
	příruba motoru	spojka	spojková skříň	sada šroubů
č. dílu typ	č. dílu typ	č. dílu typ	č. dílu typ	č. dílu typ
1202331 EAMM-A-N38-70A	1202337 EAMF-A-38D-70A	558001 EAMD-32-32-11-16X20	1345947 EAMK-A-N38-38D	1202288 EAHM-L5-M6-35
3324111 EAMM-A-N38-87A	3319868 EAMF-A-38D-87A	558001 EAMD-32-32-11-16X20	1345947 EAMK-A-N38-38D	1202288 EAHM-L5-M6-35
1202253 EAMM-A-N38-60G	1190015 EAMF-A-38D-60G/H	558001 EAMD-32-32-11-16X20	1345947 EAMK-A-N38-38D	1202262 EAHM-L5-M6-40
1201894 EAMM-A-N48-100A	1201924 EAMF-A-48C-100A	558002 EAMD-42-40-19-16X25	1345949 EAMK-A-N48-48C	1201874 EAHM-L5-M6-50
1972527 EAMM-A-N48-60G	1460111 EAMF-A-48C-60G/H	558001 EAMD-32-32-11-16X20	1345949 EAMK-A-N48-48C	1201874 EAHM-L5-M6-50
1258793 EAMM-A-N48-80G	1190375 EAMF-A-48C-80G	1781043 EAMD-42-40-20-16X25-U	1345949 EAMK-A-N48-48C	1201874 EAHM-L5-M6-50
2372096 EAMM-A-N80-80G	2372201 EAMF-A-80A-80G	558004 EAMD-56-46-20-23X27	1345953 EAMK-A-N80-80A	1201712 EAHM-L5-M8-60
1201695 EAMM-A-N80-120G	1190702 EAMF-A-80A-120G	1188801 EAMD-56-46-25-23X27	1345953 EAMK-A-N80-80A	1201712 EAHM-L5-M8-60
1201691 EAMM-A-N80-140A	1190796 EAMF-A-80A-140A	558005 EAMD-56-46-24-23X27	1345953 EAMK-A-N80-80A	1201751 EAHM-L5-M8-75

# Axiální sady EAMM-A

technické údaje

FESTO

## Rozměry a údaje pro objednávky

modely CAD ke stažení → [www.festo.com](http://www.festo.com)

EGC-HD-TB-...

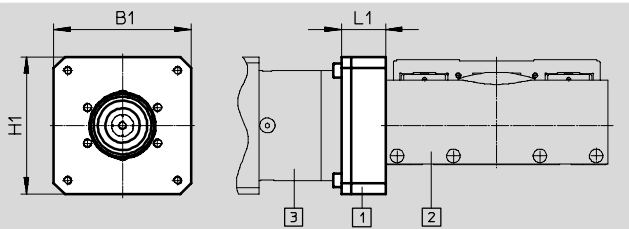

Schématický náčrt:

- 1 axiální sada
- 2 pohon s ozubeným řemenem
- 3 motor

typ	B1	H1	L1
EAMM-A-M43-60G	60	60	33
EAMM-A-M48-80G	100	100	32
EAMM-A-M80-120G	124	124	34

## Jednotlivé díly

axiální sada	součásti:		
	příruba motoru	spojka	středící kroužek
č. dílu typ	č. dílu typ	č. dílu typ	č. dílu typ
1190076 EAMM-A-M43-60G	1597579 EAMF-A-43D-60G/H	558001 EAMD-32-32-11-16X20	575962 EAML-43-4-43
1190421 EAMM-A-M48-80G	1190375 EAMF-A-48C-80G	1781043 EAMD-42-40-20-16X25-U	558031 EAML-48-4-48
1190774 EAMM-A-M80-120G	1190702 EAMF-A-80A-120G	1781045 EAMD-56-46-25-23X27-U	1209006 EAML-80-6-80

# Axiální sady EAMM-A

technické údaje

FESTO

Rozměry a údaje pro objednávky

modely CAD ke stažení → [www.festo.com](http://www.festo.com)

EGC-HD-BS...

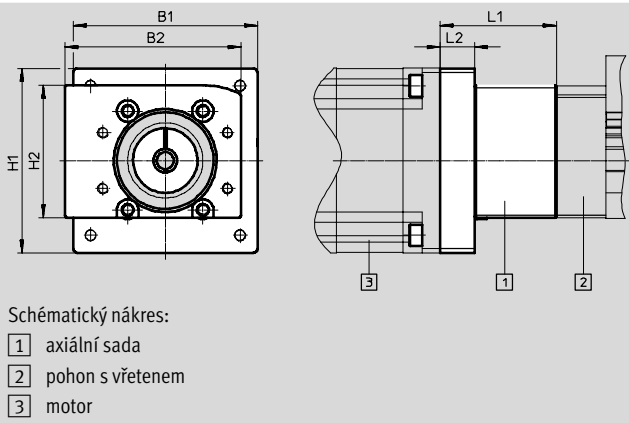





typ	B1	B2	H1	H2	L1	L2
EAMM-A-S38-40A	58	69	44	50	44	7
EAMM-A-S38-40P	58	69	44	50	54	15,5
EAMM-A-S38-42A	58	69	44	50	52	15
EAMM-A-S38-55A	55	69	55	50	48	11
EAMM-A-S38-57A	56	69	56	50	48	11
EAMM-A-S38-60P	61,4	69	61,4	50	63,2	16
EAMM-A-S48-55A	70	82	55	61,5	47,2	9,2
EAMM-A-S48-57A	70	82	55	61,5	47,2	9,2
EAMM-A-S48-60P	61,4	82	61,4	61,5	74,7	17,5
EAMM-A-S48-70A	70	82	70	61,5	50,2	12,2
EAMM-A-S48-87A	85,8	82	85,8	61,5	54	16
EAMM-A-S62-70A	82	120	70	88,5	78,5	12
EAMM-A-S62-80P	81,3	120	81,3	88,5	64,7	17,5
EAMM-A-S62-87A	85,8	120	85,8	88,5	81,5	15
EAMM-A-S62-100A	100,5	120	100,5	88,5	81	14,5
EAMM-A-S62-140A	140	120	140	88,5	91	24,5

Jednotlivé díly				
axiální sada	součásti:			
	příruba motoru	spojka	spojková skříň	sada šroubů
č. dílu typ	č. dílu typ	č. dílu typ	č. dílu typ	č. dílu typ
558162 EAMM-A-S38-40A	558175 EAMF-A-38B-40A	558312 EAMC-30-32-6-6	558171 EAMK-A-S38-38A/B	–
2219044 EAMM-A-S38-40P	2219077 EAMF-A-38B-40P	533708 EAMC-30-32-6-8	558171 EAMK-A-S38-38A/B	–
558163 EAMM-A-S38-55A	558176 EAMF-A-38A-55A	551003 EAMC-30-32-6-9	558171 EAMK-A-S38-38A/B	567488 EAHM-L2-M5-50
560685 EAMM-A-S38-42A	560691 EAMF-A-38B-42A	561333 EAMC-30-32-5-6	558171 EAMK-A-S38-38A/B	–
560686 EAMM-A-S38-57A	560692 EAMF-A-38A-57A	551002 EAMC-30-32-6-6,35	558171 EAMK-A-S38-38A/B	567488 EAHM-L2-M5-50
558164 EAMM-A-S48-55A	558177 EAMF-A-48B-55A	543423 EAMC-30-32-8-9	558172 EAMK-A-S48-48A/B	–
2219110 EAMM-A-S38-60P	1987412 EAMM-A-38A-60P	1233256 EAMC-30-32-6-14	558171 EAMK-A-S38-38A/B	567489 EAHM-L2-M5-55
560687 EAMM-A-S48-57A	560694 EAMF-A-48B-57A	543421 EAMC-30-32-6,35-8	558172 EAMK-A-S48-48A/B	–
2220560 EAMM-A-S48-60P	2220620 EAMF-A-48A-60P	562682 EAMC-30-32-8-14	558172 EAMK-A-S48-48A/B	567489 EAHM-L2-M5-55
558165 EAMM-A-S48-70A	558025 EAMF-A-48A-70A	551004 EAMC-30-32-8-11	558172 EAMK-A-S48-48A/B	567488 EAHM-L2-M5-50
560688 EAMM-A-S48-87A	560695 EAMF-A-48A-87A	551004 EAMC-30-32-8-11	558172 EAMK-A-S48-48A/B	567489 EAHM-L2-M5-55

# Axiální sady EAMM-A

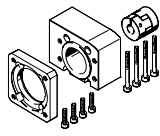
technické údaje

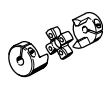
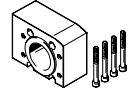
FESTO

Jednotlivé díly				
axiální sada	součásti:			
	příruba motoru	spojka	spojková skříň	sada šroubů
				
č. dílu typ	č. dílu typ	č. dílu typ	č. dílu typ	č. dílu typ
558166 EAMM-A-S62-70A	558179 EAMF-A-62B-70A	558313 EAMC-42-66-11-12	558173 EAMK-A-S62-62A/B	–
2222582 EAMM-A-S62-80P	2222624 EAMF-A-62B-80P	551005 EAMC-42-50-12-19	558173 EAMK-A-S62-62A/B	–
560689 EAMM-A-S62-87A	560696 EAMF-A-62B-87A	558313 EAMC-42-66-11-12	558173 EAMK-A-S62-62A/B	–
558167 EAMM-A-S62-100A	558026 EAMF-A-62A-100A	551005 EAMC-42-50-12-19	558173 EAMK-A-S62-62A/B	567494 EAHM-L2-M6-80
558168 EAMM-A-S62-140A	558022 EAMF-A-62A-140A	558314 EAMC-42-50-12-24	558173 EAMK-A-S62-62A/B	567495 EAHM-L2-M6-90

# Axiální sady EAMM-A

technické údaje

FESTO

## Rozměry a údaje pro objednávky

modely CAD ke stažení → [www.festo.com](http://www.festo.com)

EGSK-..., EGSP-...

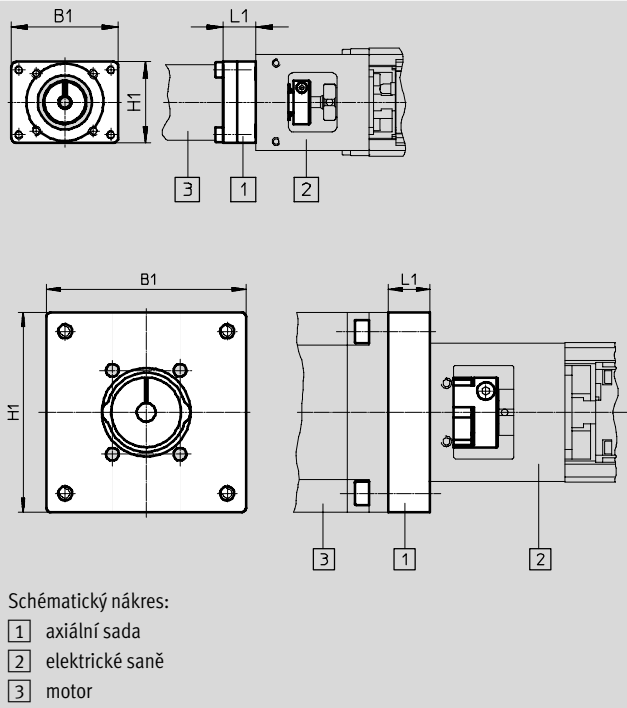

typ	B1	H1	L1
EAMM-A-P3-28D-28A	30	30	15
EAMM-A-P3-28D-40P	39,7	39,7	14,5
EAMM-A-P4-28B-28A	39,6	30	12
EAMM-A-P4-28B-40A	40	40	8,3
EAMM-A-P4-28B-40P	39,7	39,7	12,5
EAMM-A-P4-28B-42A	42	42	16,5
EAMM-A-P5-28B-28A	39,6	30	12
EAMM-A-P5-28B-40A	40	40	8,3
EAMM-A-P5-28B-40P	39,7	39,7	12,5
EAMM-A-P5-28B-42A	42	42	16,5
EAMM-A-P6-38A-40A	50	50	9
EAMM-A-P6-38A-40P	50	50	10,7
EAMM-A-P6-38A-42A	55	55	15
EAMM-A-P6-38A-55A	55	55	11
EAMM-A-P6-38A-57A	56	56	11
EAMM-A-P6-38A-60P	61,4	61,4	21
EAMM-A-P8-38A-40A	50	50	9
EAMM-A-P8-38A-40P	50	50	10,7
EAMM-A-P8-38A-42A	55	55	15
EAMM-A-P8-38A-55A	55	55	11
EAMM-A-P8-38A-57A	56	56	11
EAMM-A-P8-38A-60P	61,4	61,4	21
EAMM-A-P8-38A-70A	70	70	13,8
EAMM-A-P8-38A-87A	85,8	85,8	18
EAMM-A-P10-38A-55A	55	55	11
EAMM-A-P10-38A-57A	56	56	11
EAMM-A-P10-38A-60A	61,4	61,4	21
EAMM-A-P10-38A-70A	70	70	13,8
EAMM-A-P10-38A-87A	85,8	85,8	18

## Jednotlivé díly

axiální sada	součásti:	
	příruba motoru	spojka
č. dílu typ	č. dílu typ	č. dílu typ
1703478 EAMM-A-P3-28D-28A	1087613 EAMF-A-28D-28A	562672 EAMC-16-20-3-5
1982886 EAMM-A-P3-28D-40P	1982014 EAMF-A-28D-40P	2310368 EAMC-16-20-3-8
1731466 EAMM-A-P4-28B-28A	1704476 EAMF-A-28B-28A	562674 EAMC-16-20-4-5
1983071 EAMM-A-P4-28B-40P	1976704 EAMF-A-28B-40P	562675 EAMC-16-20-4-8
562637 EAMM-A-P4-28B-40A	552163 EAMF-A-28B-40A	562673 EAMC-16-20-4-6
562636 EAMM-A-P4-28B-42A	552164 EAMF-A-28B-42A	562674 EAMC-16-20-4-5

# Axiální sady EAMM-A

technické údaje

FESTO

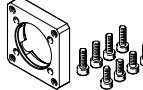
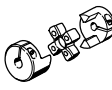
Jednotlivé díly		
axiální sada	součásti:	
	příruba motoru	spojka
		
č. dílu typ	č. dílu typ	č. dílu typ
1731474 EAMM-A-P5-28B-28A	1704476 EAMF-A-28B-28A	562676 EAMC-16-20-5-5
562641 EAMM-A-P5-28B-40A	552163 EAMF-A-28B-40A	543419 EAMC-16-20-5-6
1983122 EAMM-A-P5-28B-40P	1976704 EAMF-A-28B-40P	562677 EAMC-16-20-5-8
562640 EAMM-A-P5-28B-42A	552164 EAMF-A-28B-42A	562676 EAMC-16-20-5-5
562646 EAMM-A-P6-38A-40A	562667 EAMF-A-38A-40A	558312 EAMC-30-32-6-6
1983450 EAMM-A-P6-38A-40P	1984478 EAMF-A-38A-40P	533708 EAMC-30-32-6-8
562644 EAMM-A-P6-38A-42A	562668 EAMF-A-38A-42A	561333 EAMC-30-32-5-6
562647 EAMM-A-P6-38A-55A	558176 EAMF-A-38A-55A	551003 EAMC-30-32-6-9
562645 EAMM-A-P6-38A-57A	560692 EAMF-A-38A-57A	551002 EAMC-30-32-6-6,35
2264375 EAMM-A-P6-38A-60P	1987412 EAMF-A-38A-60P	1233256 EAMC-30-32-6-14
562652 EAMM-A-P8-38A-40A	562667 EAMF-A-38A-40A	533708 EAMC-30-32-6-8
1986292 EAMM-A-P8-38A-40P	1984478 EAMF-A-38A-40P	543422 EAMC-30-32-8-8
562650 EAMM-A-P8-38A-42A	562668 EAMF-A-38A-42A	562678 EAMC-30-32-5-8
562653 EAMM-A-P8-38A-55A	558176 EAMF-A-38A-55A	543423 EAMC-30-32-8-9
562651 EAMM-A-P8-38A-57A	560692 EAMF-A-38A-57A	543421 EAMC-30-32-6,35-8
1987308 EAMM-A-P8-38A-60P	1987412 EAMF-A-38A-60P	562682 EAMC-30-32-8-14
564996 EAMM-A-P8-38A-70A	558018 EAMF-A-38A-70A	551004 EAMC-30-32-8-11
564998 EAMM-A-P8-38A-87A	560693 EAMF-A-38A-87A	551004 EAMC-30-32-8-11
562659 EAMM-A-P10-38A-55A	558176 EAMF-A-38A-55A	562680 EAMC-30-32-9-10
562658 EAMM-A-P10-38A-57A	560692 EAMF-A-38A-57A	562679 EAMC-30-32-6,35-10
2036017 EAMM-A-P10-38A-60P	1987412 EAMF-A-38A-60P	562683 EAMC-30-32-10-14
564997 EAMM-A-P10-38A-70A	558018 EAMF-A-38A-70A	565008 EAMC-30-32-10-11
564999 EAMM-A-P10-38A-87A	560693 EAMF-A-38A-87A	565008 EAMC-30-32-10-11

# Axiální sady EAMM-A

technické údaje

FESTO

## Rozměry a údaje pro objednávky

ELGG-..., ELGR-...

modely CAD ke stažení → [www.festo.com](http://www.festo.com)

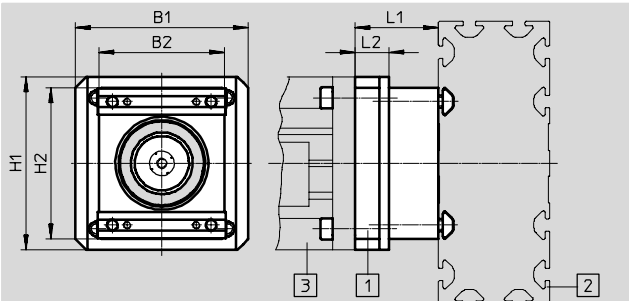

Schématický náčrt:

- 1 axiální sada
- 2 pohon s ozubeným řemenem
- 3 motor

typ	B1	B2	H1	H2	L1	L2
EAMM-A-R27-55A	55	44,5	55	48,3	26	11
EAMM-A-R27-57A	56	44,5	56	48,3	26	11
EAMM-A-R38-57A	56	-	-	-	31	-
EAMM-A-R38-60P	61,4	51	61,4	61	41	21
EAMM-A-R38-70A	70	51	70	61	33,8	13,8
EAMM-A-R38-87A	85,8	51	85,8	61	38	18
EAMM-A-R48-70A	70	-	-	-	40,2	-
EAMM-A-R48-80P	81,3	55	81,3	81	54	26
EAMM-A-R48-87A	85,5	55	85,5	81	44	16
EAMM-A-R48-100A	100,5	55	100,5	81	59	31

## Jednotlivé díly

axiální sada	součásti:		
	příruba motoru	spojka	spojková skříň
č. dílu typ	č. dílu typ	č. dílu typ	č. dílu typ
1133400 EAMM-A-R27-55A	558176 EAMF-A-38A-55A	557999 EAMD-19-15-9-8X10	1133397 EAMK-A-R27-38A
1133403 EAMM-A-R27-57A	560692 EAMF-A-38A-57A	561292 EAMD-16-15-6.35-8X10	1133397 EAMK-A-R27-38A
1578138 EAMM-A-R38-57A	560692 EAMF-A-38A-57A	561293 EAMD-25-22-6,35-10X12	1133398 EAMK-A-R38-38A
2224996 EAMM-A-R38-60P	1987412 EAMF-A-38A-60P	1453861 EAMD-28-22-14-10X12	1133398 EAMK-A-R38-38A
1133401 EAMM-A-R38-70A	558018 EAMF-A-38A-70A	558000 EAMD-25-22-11-10X12	1133398 EAMK-A-R38-38A
1133404 EAMM-A-R38-87A	560693 EAMF-A-38A-87A	558000 EAMD-25-22-11-10X12	1133398 EAMK-A-R38-38A
1578139 EAMM-A-R48-70A	558025 EAMF-A-48A-70A	558001 EAMD-32-32-11-16X20	1133399 EAMK-A-R48-48A
2225090 EAMM-A-R48-80P	2043427 EAMF-A-48A-80P	558002 EAMD-42-40-19-16X25	1133399 EAMK-A-R48-48A
1133405 EAMM-A-R48-87A	560695 EAMF-A-48A-87A	558001 EAMD-32-32-11-16X20	1133399 EAMK-A-R48-48A
1133402 EAMM-A-R48-100A	558020 EAMF-A-48A-100A	558002 EAMD-42-40-19-16X25	1133399 EAMK-A-R48-48A



# Axiální sady EAMM-A

technické údaje

FESTO

## Rozměry a údaje pro objednávky

modely CAD ke stažení → [www.festo.com](http://www.festo.com)

DGEA-...

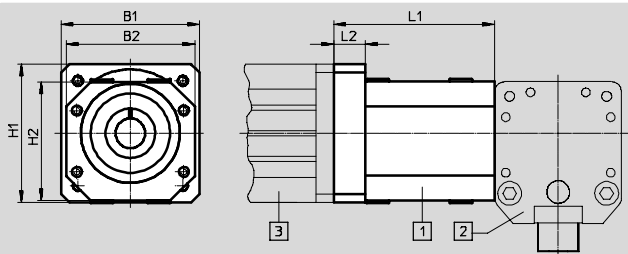

Schématický nářes:

- 1 axiální sada
- 2 letmý pohon
- 3 motor

typ	B1	B2	H1	H2	L1	L2
EAMM-A-F28-57A	56,4	45	56,4	45	52,7	12
EAMM-A-F28-60G	60	45	60	45	60,7	20
EAMM-A-F28-87A	85,8	45	85,8	45	56,2	15,5
EAMM-A-F32-60G	70	65	70	60	89,4	24
EAMM-A-F32-87A	85,8	65	85,8	60	82,7	17,5
EAMM-A-F40-80G	90	65	90	60	89,4	24

## Jednotlivé díly

axiální sada	součásti:		
	příruba motoru	spojka	spojková skříň
č. dílu typ	č. dílu typ	č. dílu typ	č. dílu typ
550956 EAMM-A-F28-57A	530081 EAMF-A-44A/B-57A	530088 EAMC-30-35-6,35-8	530468 EAMK-A-F28-44A
550957 EAMM-A-F28-60G	529944 EAMF-A-44A/B-60G	123042 EAMC-30-35-8-11	530468 EAMK-A-F28-44A
550958 EAMM-A-F28-87A	530082 EAMF-A-44A/B-87A	123042 EAMC-30-35-8-11	530468 EAMK-A-F28-44A
550959 EAMM-A-F32-60G	550987 EAMF-A-64A/B-60G/H	530090 EAMC-40-66-11-11	530469 EAMK-A-F32-64A
550960 EAMM-A-F32-87A	533140 EAMF-A-64A/B-87A	530090 EAMC-40-66-11-11	530469 EAMK-A-F32-64A
550935 EAMM-A-F40-80G	533139 EAMF-A-64A/C-80G	123845 EAMC-40-66-15-20	124629 EAMK-A-F40-64A

# Axiální sady EAMM-A

příslušenství

FESTO

## Sady těsnění

obsahují látky LABS

(bránící nanášení laků)

odpovídá RoHS

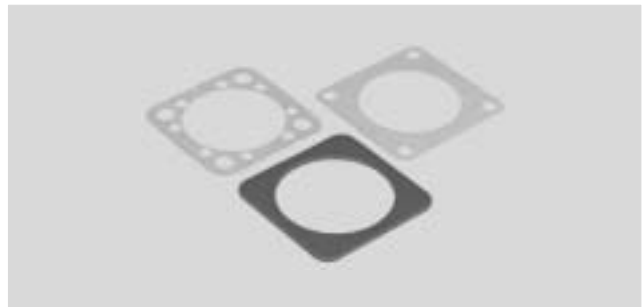

Údaje pro objednávky						
typ	pro axiální sadu	pro elektrický válec	teplota okolí [°C]	KBK <sup>1)</sup>	č. dílu	typ
EADS-F-D32-40A	EAMM-A-D32-40A	DNCE	-25 ... +60	4	1561526	EADS-F-D32-40A
EADS-F-D32-40P	EAMM-A-D32-40P	DNCE			2207219	EADS-F-D32-40P
EADS-F-D32-60P	EAMM-A-D32-60P	DNCE			2234012	EADS-F-D32-60P
EADS-F-D32-42A	EAMM-A-D32-42A	DNCE			1561527	EADS-F-D32-42A
EADS-F-D32-55A	EAMM-A-D32-55A	DNCE			1561528	EADS-F-D32-55A
EADS-F-D32-57A	EAMM-A-D32-57A	DNCE			1561529	EADS-F-D32-57A
EADS-F-D40-55A	EAMM-A-D40-55A	DNCE			1561530	EADS-F-D40-55A
EADS-F-D40-57A	EAMM-A-D40-57A	DNCE			1561531	EADS-F-D40-57A
EADS-F-D40-60P	EAMM-A-D40-60P	DNCE			2151545	EADS-F-D40-60P
EADS-F-D40-70A	EAMM-A-D40-70A	DNCE			1561532	EADS-F-D40-70A
EADS-F-D40-87A	EAMM-A-D40-87A	DNCE			1561533	EADS-F-D40-87A
EADS-F-D60A-70A	EAMM-A-D60A-70A	DNCE			1561534	EADS-F-D60A-70A
EADS-F-D60-80P	EAMM-A-D60-80P	DNCE, ESBF			2218523	EADS-F-D60-80P
EADS-F-D60-87A	EAMM-A-D60-87A	DNCE			1561536	EADS-F-D60-87A
EADS-F-D60A-100A	EAMM-A-D60A-100A	DNCE			1561537	EADS-F-D60A-100A
EADS-F-D60B-70A	EAMM-A-D60B-70A	ESBF			1679570	EADS-F-D60B-70A
EADS-F-D60B-100A	EAMM-A-D60B-100A	ESBF			1679522	EADS-F-D60B-100A
EADS-F-D80-100A	EAMM-A-D80-100A	ESBF			1593617	EADS-F-D80-100A
EADS-F-D80-140A	EAMM-A-D80-140A	ESBF			1593671	EADS-F-D80-140A
EADS-F-D100-140A	EAMM-A-D100-140A	ESBF			1593991	EADS-F-D100-140A

1) Třída odolnosti korozi 4 dle normy Festo 940 070: konstrukční díly s obzvlášť přísnými nároky na odolnost korozi. Díly do prostoru s agresivními látkami, například v potravinářství nebo v chemickém průmyslu. Použití těchto dílů je nutné v daném případě ověřit speciálními testy s příslušnými látkami (→ také FN 940082).