

Axiálne konštrukčné zostavy EAMM-A

FESTO



Axiálne konštrukčné zostavy EAMM-A

legenda k typovému označeniu

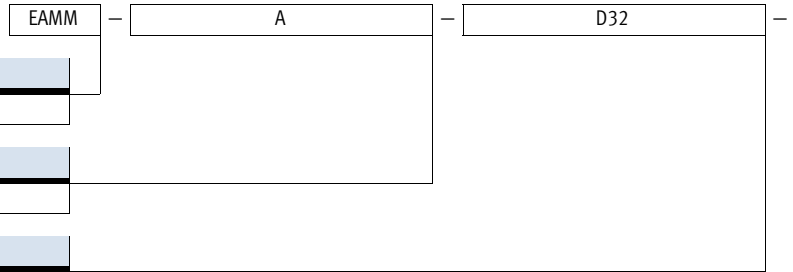

typ	
EAMM	súprava

umiestnenie motora	
A	axiálne

rozhranie mechanika osi	
D19	EGSL-35
D32	DNCE-32, EGSL-45
D32-35A	ERMB-20, EHMB-20
D40	DNCE-40; EGSL-55, ERMB-25, EHMB-25
D60	DNCE-63; EGSL-75, ERMB-32, EHMB-32
D60	ESBF-63
D80	ESBF-80
D100	ESBF-100
E20	DGE-18-...-SP, DMES-18
E32	DGE-25-...-SP, DMES-25
E48	DGE-40-...-SP, DMES-40
E72	DGE-63-...-SP, DMES-63
F28	DGEA-18
F30	DGE-25-...-ZR
F32	DGEA-25
F37	DGE-25-...-ZR-RF
F40	DGE-40-...-ZR, DGEA-40
F47	DGE-40-...-ZR-RF
F62	DGE-63-...-ZR
F80	DGE-63-...-ZR-RF
G13	DGE-8-...-ZR
G16	DGE-12-...-ZR
G19	DGE-18-...-ZR
L27	EGC-50-...-TB
L38	EGC-70-...-TB
L48	EGC-80-...-TB
L62	EGC-120-...-TB
L95	EGC-185-...-TB
M43	EGC-HD-125-...-TB
M48	EGC-HD-160-...-TB
M80	EGC-HD-220-...-TB
N38	ELGA-TB-...-70
N48	ELGA-TB-...-80
N80	ELGA-TB-...-120
P3-28D	EGSK-15
P4-28B	EGSK-20/EGSP-20
P5-28B	EGSK-26/EGSP-26
P6-38A	EGSK-33
P8-38A	EGSK-46, EGSP-33
P10-38A	EGSP-46
R27	ELGG-...-35, ELGR-...-35
R38	ELGG-...-45, ELGR-...-45
R48	ELGG-...-55, ELGR-...-55
S38	EGC-70-...-BS, EGC-HD-125-...-BS
S48	EGC-80-...-BS, EGC-HD-160-...-BS
S62	EGC-120-...-BS, EGC-HD-220-...-BS
S95	EGC-185-...-BS

Axiálne konštrukčné zostavy EAMM-A

legenda k typovému označeniu

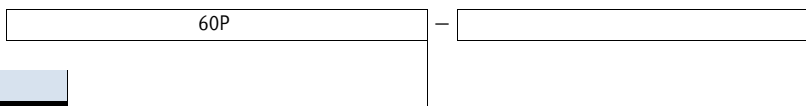

rozhranie motor	
40P	servomotor EMME-AS-40
60P	servomotor EMME-AS-60
80P	servomotor EMME-AS-80
40A	servomotor EMMS-AS-40
55A	servomotor EMMS-AS-55
70A	servomotor EMMS-AS-70
100A	servomotor EMME-AS-100, EMMS-AS-100
140A	servomotor EMMS-AS-140
190A	servomotor EMMS-AS-190
28A	krokový motor EMMS-ST-28
42A	krokový motor EMMS-ST-42
57A	krokový motor EMMS-ST-57
87A	krokový motor EMMS-ST-87
32B	motorová jednotka MTR-DCI-32-...-G7/G14
42B	motorová jednotka MTR-DCI-42-...-G7
42C	motorová jednotka MTR-DCI-42-...-G14
52B	motorová jednotka MTR-DCI-52-...-G7
52C	motorová jednotka MTR-DCI-52-...-G14
62B	motorová jednotka MTR-DCI-62-...-G7/G14/G22
40G	prevodovka EMGA-40
60G	prevodovka EMGA-60-...-SAS/SST
60H	prevodovka EMGA-60-...-EAS
80G	prevodovka EMGA-80
120G	prevodovka EMGA-120
160G	prevodovka EMGA-160

špeciálne vyhotovenie	
S1	krytie IP65

Axiálne konštrukčné zostavy EAMM-A

prehľad dodávok

FESTO

Prípustné kombinácie os/motor s osou s ozubeným remeňom DGE-ZR

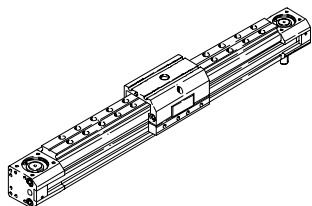

motor/prevodovka typ	axiálna konštrukčná zostava	
	č. dielu	typ
DGE-8-...-ZR		
so servomotorom		
EMMS-AS-40-...	550921	EAMM-A-G13-40A
s krokovým motorom		
EMMS-ST-42-...	550922	EAMM-A-G13-42A
DGE-12-...-ZR		
so servomotorom		
EMMS-AS-40-...	550923	EAMM-A-G16-40A
EMMS-AS-55-...	550925	EAMM-A-G16-55A
s krokovým motorom		
EMMS-ST-42-...	550924	EAMM-A-G16-42A
DGE-18-...-ZR		
so servomotorom		
EMMS-AS-40-...	550926	EAMM-A-G19-40A
EMMS-AS-55-...	550927	EAMM-A-G19-55A
s krokovým motorom		
EMMS-ST-57-...	550928	EAMM-A-G19-57A
DGE-25-...-ZR		
so servomotorom		
EMMS-AS-55-...	550929	EAMM-A-F30-55A
EMMS-AS-70-...	550932	EAMM-A-F30-70A
so servomotorom a prevodovkou		
EMMS-AS-55-...	550931	EAMM-A-F30-60G
EMGA-60-P-G...-SAS-55		
s krokovým motorom		
EMMS-ST-57-...	550930	EAMM-A-F30-57A
EMMS-ST-87-...	550933	EAMM-A-F30-87A
s krokovým motorom a prevodovkou		
EMMS-ST-57-...	550931	EAMM-A-F30-60G
EMGA-60-P-G...-SST-57		
DGE-25-...-ZR-RF		
so servomotorom		
EMMS-AS-55-...	550942	EAMM-A-F37-55A
EMMS-AS-70-...	550945	EAMM-A-F37-70A
so servomotorom a prevodovkou		
EMMS-AS-55-...	550944	EAMM-A-F37-60G
EMGA-60-P-G...-SAS-55		
s krokovým motorom		
EMMS-ST-57-...	550943	EAMM-A-F37-57A
EMMS-ST-87-...	550946	EAMM-A-F37-87A
s krokovým motorom a prevodovkou		
EMMS-ST-57-...	550944	EAMM-A-F37-60G
EMGA-60-P-G...-SST-57		

motor/prevodovka typ	axiálna konštrukčná zostava	
	č. dielu	typ
DGE-40-...-ZR		
so servomotorom		
EMMS-AS-70-...	550934	EAMM-A-F40-70A
EMME-AS-100-...	550937	EAMM-A-F40-100A
EMMS-AS-100-...	550937	EAMM-A-F40-100A
so servomotorom a prevodovkou		
EMMS-AS-70-...	550935	EAMM-A-F40-80G
EMGA-80-P-G...-SAS-70		
EMME-AS-80-...	550935	EAMM-A-F40-80G
EMGA-80-P-G...-EAS-80		
EMME-AS-100-...	550935	EAMM-A-F40-80G
EMGA-80-P-G...-SAS-100		
EMMS-AS-100-...	550935	EAMM-A-F40-80G
EMGA-80-P-G...-SAS-100		
s krokovým motorom		
EMMS-ST-87-...	550936	EAMM-A-F40-87A
s krokovým motorom a prevodovkou		
EMMS-ST-87-...	550935	EAMM-A-F40-80G
EMGA-80-P-G...-SST-87		
DGE-40-...-ZR-RF		
so servomotorom		
EMME-AS-100-...	550949	EAMM-A-F47-100A
EMMS-AS-100-...	550949	EAMM-A-F47-100A
EMMS-AS-140-...	550950	EAMM-A-F47-140A
so servomotorom a prevodovkou		
EMME-AS-80-...	550947	EAMM-A-F47-80G
EMGA-80-P-G...-EAS-80		
EMME-AS-100-...	550947	EAMM-A-F47-80G
EMGA-80-P-G...-SAS-100		
EMMS-AS-100-...	550947	EAMM-A-F47-80G
EMGA-80-P-G...-SAS-100		
s krokovým motorom		
EMMS-ST-87-...	550948	EAMM-A-F47-87A
s krokovým motorom a prevodovkou		
EMMS-ST-87-...	550947	EAMM-A-F47-80G
EMGA-80-P-G...-SST-87		

Axiálne konštrukčné zostavy EAMM-A

prehľad dodávok

FESTO

Prípustné kombinácie os/motor s osou s ozubeným remeňom DGE-ZR

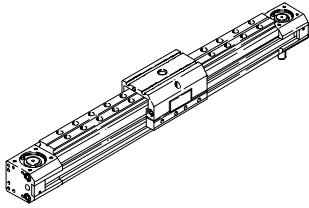

motor/prevodovka	axiálna konštrukčná zostava	
typ	č. dielu	typ
DGE-63-...-ZR		
so servomotorom		
EMME-AS-100-...	550939	EAMM-A-F62-100A
EMMS-AS-100-...	550939	EAMM-A-F62-100A
EMMS-AS-140-...	550941	EAMM-A-F62-140A
so servomotorom a prevodovkou		
EMME-AS-80-... EMGA-80-P-G...-EAS-80	550938	EAMM-A-F62-80G
EMME-AS-100-... EMGA-80-P-G...-SAS-100	550938	EAMM-A-F62-80G
EMMS-AS-100-... EMGA-80-P-G...-SAS-100	550938	EAMM-A-F62-80G
EMME-AS-100-... EMGA-120-P-G...-SAS-100	550940	EAMM-A-F62-120G
EMMS-AS-100-... EMGA-120-P-G...-SAS-100	550940	EAMM-A-F62-120G
EMMS-AS-140-... EMGA-120-P-G...-SAS-140	550940	EAMM-A-F62-120G
s krokovým motorom a prevodovkou		
EMMS-ST-87-... EMGA-80-P-G...-SST-87	550938	EAMM-A-F62-80G
DGE-63-...-ZR-RF		
so servomotorom		
EMME-AS-100-...	550952	EAMM-A-F80-100A
EMMS-AS-100-...	550952	EAMM-A-F80-100A
EMMS-AS-140-...	550954	EAMM-A-F80-140A
so servomotorom a prevodovkou		
EMME-AS-80-... EMGA-80-P-G...-EAS-80	550951	EAMM-A-F80-80G
EMME-AS-100-... EMGA-80-P-G...-SAS-100	550951	EAMM-A-F80-80G
EMMS-AS-100-... EMGA-80-P-G...-SAS-100	550951	EAMM-A-F80-80G
EMME-AS-100-... EMGA-120-P-G...-SAS-100	550951	EAMM-A-F80-120G
EMMS-AS-100-... EMGA-120-P-G...-SAS-100	550951	EAMM-A-F80-120G
EMMS-AS-140-... EMGA-120-P-G...-SAS-140	550953	EAMM-A-F80-120G
EMMS-AS-140-... EMGA-160-P-G...-SAS-140	550955	EAMM-A-F80-160G
s krokovým motorom a prevodovkou		
EMMS-ST-87-... EMGA-80-P-G...-SST-87	550951	EAMM-A-F80-80G

Axiálne konštrukčné zostavy EAMM-A

prehľad dodávok

FESTO

Prípustné kombinácie os/motor s osou s vretenom DGE-SP

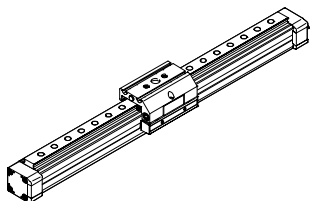

motor/prevodovka typ	axiálna konštrukčná zostava	
	č. dielu	typ
DGE-18		
so servomotorom		
EMMS-AS-40-...	550961	EAMM-A-E20-40A
EMMS-AS-55-...	550963	EAMM-A-E20-55A
s krokovým motorom		
EMMS-ST-42-...	550962	EAMM-A-E20-42A
DGE-25		
so servomotorom		
EMMS-AS-40-...	550964	EAMM-A-E32-40A
EMMS-AS-55-...	550965	EAMM-A-E32-55A
s krokovým motorom		
EMMS-ST-57-...	550966	EAMM-A-E32-57A
DGE-40		
so servomotorom		
EMMS-AS-55-...	550969	EAMM-A-E48-55A
EMMS-AS-70-...	550971	EAMM-A-E48-44A-70A
EMME-AS-100-...	550973	EAMM-A-E48-100A
EMMS-AS-100-...	550973	EAMM-A-E48-100A
so servomotorom a prevodovkou		
EMME-AS-40-...	550968	EAMM-A-E48-40G
EMGA-40-P-G...-EAS-40		
EMMS-AS-40-...	550968	EAMM-A-E48-40G
EMGA-40-P-G...-SAS-40		
s krokovým motorom		
EMMS-ST-57-...	550970	EAMM-A-E48-57A
EMMS-ST-87-...	550972	EAMM-A-E48-87A

motor/prevodovka typ	axiálna konštrukčná zostava	
	č. dielu	typ
DGE-63		
so servomotorom		
EMMS-AS-70-...	550975	EAMM-A-E72-70A
EMME-AS-100-...	550978	EAMM-A-E72-100A
EMMS-AS-100-...	550978	EAMM-A-E72-100A
so servomotorom a prevodovkou		
EMMS-AS-70-...	550974	EAMM-A-E72-60G
EMGA-60-P-G...-SAS-70		
EMMS-AS-70-...	550976	EAMM-A-E72-80G
EMGA-80-P-G...-SAS-70		
EMME-AS-80-...	550976	EAMM-A-E72-80G
EMGA-80-P-G...-EAS-80		
EMME-AS-100-...	550976	EAMM-A-E72-80G
EMGA-80-P-G...-SAS-100		
EMMS-AS-100-...	550976	EAMM-A-E72-80G
EMGA-80-P-G...-SAS-100		
s krokovým motorom		
EMMS-ST-87-...	550977	EAMM-A-E72-87A
s krokovým motorom a prevodovkou		
EMMS-ST-87-...	550976	EAMM-A-E72-80G
EMGA-80-P-G...-SST-87		

Axiálne konštrukčné zostavy EAMM-A

prehľad dodávok

FESTO

Prípustné kombinácie os/motor s nastavovacou osou DMES

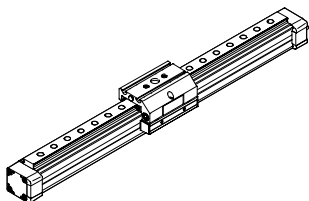

motor/prevodovka	axiálna konštrukčná zostava	
typ	č. dielu	typ
DMES-18		
so servomotorom		
EMMS-AS-40-...	550961	EAMM-A-E20-40A
EMMS-AS-55-...	550963	EAMM-A-E20-55A
s krokovým motorom		
EMMS-ST-42-...	550962	EAMM-A-E20-42A
s motorovou jednotkou		
MTR-DCI-32S-...	556991	EAMM-A-E20-32B
DMES-25		
so servomotorom		
EMMS-AS-40-...	550964	EAMM-A-E32-40A
EMMS-AS-55-...	550965	EAMM-A-E32-55A
s krokovým motorom		
EMMS-ST-57-...	550966	EAMM-A-E32-57A
s motorovou jednotkou		
MTR-DCI-42S-...G7	556992	EAMM-A-E32-42B
MTR-DCI-42S-...G14	556993	EAMM-A-E32-42C
DMES-40		
so servomotorom		
EMMS-AS-55A-...	550969	EAMM-A-E48-55A
EMMS-AS-70-...	557448	EAMM-A-E48-64A-70A
EMME-AS-100-...	550973	EAMM-A-E48-100A
EMMS-AS-100-...	550973	EAMM-A-E48-100A
so servomotorom a prevodovkou		
EMME-AS-40-...	550968	EAMM-A-E48-40G
EMGA-40-P-G...-EAS-40		
EMMS-AS-40-...	550968	EAMM-A-E48-40G
EMGA-40-P-G...-SAS-40		
s krokovým motorom		
EMMS-ST-57A-...	550970	EAMM-A-E48-57A
EMMS-ST-87-...	550972	EAMM-A-E48-87A
s motorovou jednotkou		
MTR-DCI-52S-...-G7	556994	EAMM-A-E48-52B
MTR-DCI-52S-...-G14	556995	EAMM-A-E48-52C

motor/prevodovka	axiálna konštrukčná zostava	
typ	č. dielu	typ
DMES-63		
so servomotorom		
EMMS-AS-70-...	550975	EAMM-A-E72-70A
EMME-AS-100-...	550978	EAMM-A-E72-100A
EMMS-AS-100-...	550978	EAMM-A-E72-100A
so servomotorom a prevodovkou		
EMMS-AS-70-...	550974	EAMM-A-E72-60G
EMGA-60-P-G...-SAS-70		
EMMS-AS-70-...	550976	EAMM-A-E72-80G
EMGA-80-P-G...-SAS-70		
EMME-AS-80-...	550976	EAMM-A-E72-80G
EMGA-80-P-G...-EAS-80		
EMME-AS-100-...	550976	EAMM-A-E72-80G
EMGA-80-P-G...-SAS-100		
EMMS-AS-100-...	550976	EAMM-A-E72-80G
EMGA-80-P-G...-SAS-100		
s krokovým motorom		
EMMS-ST-87-...	550977	EAMM-A-E72-87A
s krokovým motorom a prevodovkou		
EMMS-ST-87-...	550976	EAMM-A-E72-80G
EMGA-80-P-G...-SST-87		
s motorovou jednotkou		
MTR-DCI-62S-...	556996	EAMM-A-E72-62B

Axiálne konštrukčné zostavy EAMM-A

prehľad dodávok

FESTO

Prípustné kombinácie os/motor s elektrickým valcom DNCE

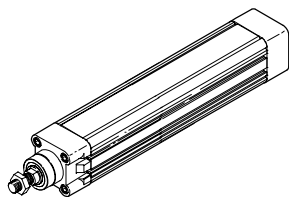

motor/prevodovka	axiálna konštrukčná zostava	
typ	č. dielu	typ
DNCE-32		
so servomotorom		
EMME-AS-40-...	1976465	EAMM-A-D32-40P
	2207372	EAMM-A-D32-40P-S1 ¹⁾
EMMS-AS-40-...	543147	EAMM-A-D32-40A
	1322178	EAMM-A-D32-40A-S1 ¹⁾
EMMS-AS-55-...	550979	EAMM-A-D32-55A
	1322180	EAMM-A-D32-55A-S1 ¹⁾
EMME-AS-60-...	1956054	EAMM-A-D32-60P
	2234020	EAMM-A-D32-60P-S1 ¹⁾
s krokovým motorom		
EMMS-ST-42-...	543148	EAMM-A-D32-42A
	1322179	EAMM-A-D32-42A-S1 ¹⁾
EMMS-ST-57-...	550980	EAMM-A-D32-57A
	1322181	EAMM-A-D32-57A-S1 ¹⁾
s motorovou jednotkou		
MTR-DCI-32S-... ²⁾	543149	EAMM-A-D32-32B
DNCE-40		
so servomotorom		
EMMS-AS-55-...	543153	EAMM-A-D40-55A
	1322182	EAMM-A-D40-55A-S1 ¹⁾
EMME-AS-60-...	1977000	EAMM-A-D40-60P
	2151519	EAMM-A-D40-60P-S1 ¹⁾
EMMS-AS-70-...	550981	EAMM-A-D40-70A
	1322185	EAMM-A-D40-70A-S1 ¹⁾
so servomotorom a prevodovkou		
EMME-AS-40-...	560282	EAMM-A-D40-40G
EMGA-40-P-G...-EAS-40		
EMMS-AS-40-...	560282	EAMM-A-D40-40G
EMGA-40-P-G...-SAS-40		
s krokovým motorom		
EMMS-ST-57-...	543154	EAMM-A-D40-57A
	1322183	EAMM-A-D40-57A-S1 ¹⁾
EMMS-ST-87-...	550982	EAMM-A-D40-87A
	1322186	EAMM-A-D40-87A-S1 ¹⁾
s krokovým motorom a prevodovkou		
EMMS-ST-42-...	560282	EAMM-A-D40-40G
EMGA-40-P-G...-SST-42		
s motorovou jednotkou		
MTR-DCI-42S-...-G7 ²⁾	543155	EAMM-A-D40-42B
MTR-DCI-42S-...-G14 ²⁾	543156	EAMM-A-D40-42C

motor/prevodovka	axiálna konštrukčná zostava	
typ	č. dielu	typ
DNCE-63		
so servomotorom		
EMMS-AS-70-...	543161	EAMM-A-D60-70A
	1322187	EAMM-A-D60-70A-S1 ¹⁾
EMME-AS-80-...	1977073	EAMM-A-D60-80P
	2218564	EAMM-A-D60-80P-S1 ¹⁾
EMME-AS-100-...	550983	EAMM-A-D60-100A
	1322190	EAMM-A-D60-100A-S1 ¹⁾
EMMS-AS-100-...	550983	EAMM-A-D60-100A
	1322190	EAMM-A-D60-100A-S1 ¹⁾
so servomotorom a prevodovkou		
EMMS-AS-55-...	560283	EAMM-A-D60-60G
EMGA-60-P-G...-SAS-55		
EMMS-AS-70-...	560283	EAMM-A-D60-60G
EMGA-60-P-G...-SAS-70		
s krokovým motorom		
EMMS-ST-87-...	543162	EAMM-A-D60-87A
	1322188	EAMM-A-D60-87A-S1 ¹⁾
s krokovým motorom a prevodovkou		
EMMS-ST-57-...	560283	EAMM-A-D60-60G
EMGA-60-P-G...-SST-57		
s motorovou jednotkou		
MTR-DCI-52S-...-G7 ²⁾	543163	EAMM-A-D60-52B
MTR-DCI-52S-...-G14 ²⁾	543164	EAMM-A-D60-52C

1) s krytím IP65

2) iba v kombinácii s DNCE-...-LS

 upozornenie

Pomocou sady tesnení EADS-F možno IP40 na krytie IP65.
vylepšiť axiálnu konštrukčnú zostavu → 50
(bez „S1“ v typovom kóde) z krytia

Axiálne konštrukčné zostavy EAMM-A

prehľad dodávok

FESTO

Prípustné kombinácie os/motor s elektrickým valcom ESBF

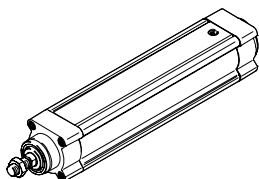

motor/prevodovka	axiálna konštrukčná zostava	
typ	č. dielu	typ
ESBF-63		
so servomotorom		
EMMS-AS-70-...	543161	EAMM-A-D60-70A
	1679566	EAMM-A-D60-70A-S1 ¹⁾
EMME-AS-80-...	1977073	EAMM-A-D60-80P
	2218564	EAMM-A-D60-80P-S1 ¹⁾
EMME-AS-100-...	550983	EAMM-A-D60-100A
	1679518	EAMM-A-D60-100A-S1 ¹⁾
EMMS-AS-100-...	550983	EAMM-A-D60-100A
	1679518	EAMM-A-D60-100A-S1 ¹⁾
so servomotorom a prevodovkou		
EMMS-AS-55-...	560283	EAMM-A-D60-60G
EMGA-60-P-G...-SAS-55		
EMMS-AS-70-...	560283	EAMM-A-D60-60G
EMGA-60-P-G...-SAS-70		
s krokovým motorom		
EMMS-ST-87-...	543162	EAMM-A-D60-87A
	1322188	EAMM-A-D60-87A-S1 ¹⁾
s krokovým motorom a prevodovkou		
EMMS-ST-57-...	560283	EAMM-A-D60-60G
EMGA-60-P-G...-SST-57		
ESBF-80		
so servomotorom		
EMME-AS-100-...	1589665	EAMM-A-D80-100A
	1600673	EAMM-A-D80-100A-S1 ¹⁾
EMMS-AS-100-...	1589665	EAMM-A-D80-100A
	1600673	EAMM-A-D80-100A-S1 ¹⁾
EMMS-AS-140-...	1588299	EAMM-A-D80-140A
	1600674	EAMM-A-D80-140A-S1 ¹⁾
ESBF-100		
so servomotorom		
EMMS-AS-140-...	1588349	EAMM-A-D100-140A
	1600675	EAMM-A-D100-140A-S1 ¹⁾

1) s krytím IP65

-  - upozornenie

Pomocou sady tesnení EADS-F možno vylepšiť axiálnu konštrukčnú zostavu (bez „S1“ v typovom kóde) z krytia IP40 na krytie IP65.

→ 50

Axiálne konštrukčné zostavy EAMM-A

prehľad dodávok

FESTO

Prípustné kombinácie os/motor s osou s ozubeným remeňom EGC-TB

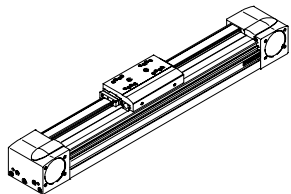

motor/prevodovka	axiálna konštrukčná zostava	
typ	č. dielu	typ
EGC -50		
so servomotorom		
EMMS-AS-55-...	557975	EAMM-A-L27-55A
so servomotorom a prevodovkou		
EMME-AS-40-...	557974	EAMM-A-L27-40G
EMGA-40-P-G...-EAS-40		
EMMS-AS-40-...	557974	EAMM-A-L27-40G
EMGA-40-P-G...-SAS-40		
s krokovým motorom		
EMMS-ST-57-...	560678	EAMM-A-L27-57A
s krokovým motorom a prevodovkou		
EMMS-ST-42-...	557974	EAMM-A-L27-40G
EMGA-40-P-G...-SST-42		
EGC -70		
so servomotorom		
EMME-AS-60-...	2037246	EAMM-A-L38-60P
EMMS-AS-70-...	557979	EAMM-A-L38-70A
so servomotorom a prevodovkou		
EMMS-AS-55-...	557978	EAMM-A-L38-60G
EMGA-60-P-G...-SAS-55		
EMMS-AS-70-...	557978	EAMM-A-L38-60G
EMGA-60-P-G...-SAS-70		
s krokovým motorom		
EMMS-ST-57-...	560679	EAMM-A-L38-57A
EMMS-ST-87-...	560680	EAMM-A-L38-87A
s krokovým motorom a prevodovkou		
EMMS-ST-57-...	557978	EAMM-A-L38-60G
EMGA-60-P-G...-SST-57		
EGC-80		
so servomotorom		
EMMS-AS-70-...	557982	EAMM-A-L48-70A
EMME-AS-80-...	2042616	EAMM-A-L48-80P
EMMS-AS-100-...	557984	EAMM-A-L48-100A
so servomotorom a prevodovkou		
EMMS-AS-55-...	557983	EAMM-A-L48-60G
EMGA-60-P-G...-SAS-55		
EMMS-AS-70-...	557983	EAMM-A-L48-60G
EMGA-60-P-G...-SAS-70		
s krokovým motorom		
EMMS-ST-87-...	560683	EAMM-A-L48-87A
s krokovým motorom a prevodovkou		
EMMS-ST-57-...	557983	EAMM-A-L48-60G
EMGA-60-P-G...-SST-57		

motor/prevodovka	axiálna konštrukčná zostava	
typ	č. dielu	typ
EGC-120		
so servomotorom		
EMME-AS-100-...	557988	EAMM-A-L62-100A
EMMS-AS-100-...	557988	EAMM-A-L62-100A
EMMS-AS-140-...	557990	EAMM-A-L62-140A
so servomotorom a prevodovkou		
EMMS-AS-70-...	557989	EAMM-A-L62-80G
EMGA-80-P-G...-SAS-70		
EMME-AS-80-...	557989	EAMM-A-L62-80G
EMGA-80-P-G...-EAS-80		
EMME-AS-100-...	557989	EAMM-A-L62-80G
EMGA-80-P-G...-SAS-100		
EMMS-AS-100-...	557989	EAMM-A-L62-80G
EMGA-80-P-G...-SAS-100		
s krokovým motorom a prevodovkou		
EMMS-ST-87-...	557989	EAMM-A-L62-80G
EMGA-80-P-G...-SST-87		
EGC-185		
so servomotorom		
EMMS-AS-140-...	557994	EAMM-A-L95-140A
EMMS-AS-190-...	1378474	EAMM-A-L95-190A
so servomotorom a prevodovkou		
EMME-AS-100-...	557995	EAMM-A-L95-120G
EMGA-120-P-G...-SAS-100		
EMMS-AS-100-...	557995	EAMM-A-L95-120G
EMGA-120-P-G...-SAS-100		
EMMS-AS-140-...	557995	EAMM-A-L95-120G
EMGA-120-P-G...-SAS-140		

Axiálne konštrukčné zostavy EAMM-A

prehľad dodávok

FESTO

Prípustné kombinácie os/motor s osou s vretenom EGC-BS

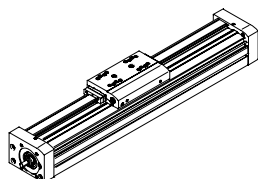

motor/prevodovka	axiálna konštrukčná zostava	
typ	č. dielu	typ
EGC-70		
so servomotorom		
EMME-AS-40-...	2219044	EAMM-A-S38-40P
EMMS-AS-40-...	558162	EAMM-A-S38-40A
EMMS-AS-55-...	558163	EAMM-A-S38-55A
EMME-AS-60-...	2219110	EAMM-A-S38-60P
s krokovým motorom		
EMMS-ST-42-...	560685	EAMM-A-S38-42A
EMMS-ST-57-...	560686	EAMM-A-S38-57A
EGC-80		
so servomotorom		
EMMS-AS-55-...	558164	EAMM-A-S48-55A
EMME-AS-60-...	2220560	EAMM-A-S48-60P
EMMS-AS-70-...	558165	EAMM-A-S48-70A
s krokovým motorom		
EMMS-ST-57-...	560687	EAMM-A-S48-57A
EMMS-ST-87-...	560688	EAMM-A-S48-87A

motor/prevodovka	axiálna konštrukčná zostava	
typ	č. dielu	typ
EGC-120		
so servomotorom		
EMMS-AS-70-...	558166	EAMM-A-S62-70A
EMME-AS-80-...	2222582	EAMM-A-S62-80P
EMME-AS-100-...	558167	EAMM-A-S62-100A
EMMS-AS-100-...	558167	EAMM-A-S62-100A
EMMS-AS-140-...	558168	EAMM-A-S62-140A
s krokovým motorom		
EMMS-ST-87-...	560689	EAMM-A-S62-87A
EGC-185		
so servomotorom		
EMME-AS-100-...	558169	EAMM-A-S95-100A
EMMS-AS-100-...	558169	EAMM-A-S95-100A
EMMS-AS-140-...	558170	EAMM-A-S95-140A

Axiálne konštrukčné zostavy EAMM-A

prehľad dodávok

FESTO

Prípustné kombinácie os/motor s osou s ozubeným remeňom ELGA-TB

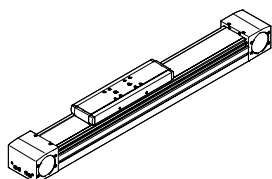

motor/prevodovka	axiálna konštrukčná zostava	
typ	č. dielu	typ
ELGA-TB-...-70		
so servomotorom		
EMMS-AS-70-...	1202331	EAMM-A-N38-70A
so servomotorom a prevodovkou		
EMMS-AS-55-...	1202253	EAMM-A-N38-60G
EMGA-60-P-G...-SAS-55		
EMMS-AS-70-...	1202253	EAMM-A-N38-60G
EMGA-60-P-G...-SAS-70		
s krokovým motorom a prevodovkou		
EMMS-ST-57-...	1202253	EAMM-A-N38-60G
EMGA-60-P-G...-SST-57		
ELGA-TB-...-80		
so servomotorom		
EMMS-AS-100-...	1201894	EAMM-A-N48-100A
so servomotorom a prevodovkou		
EMMS-AS-70-...	1258793	EAMM-A-N48-80G
EMGA-80-P-G...-SAS-70		
EMME-AS-80-...	1258793	EAMM-A-N48-80G
EMGA-80-P-G...-EAS-80		
EMME-AS-100-...	1258793	EAMM-A-N48-80G
EMGA-80-P-G...-SAS-100		
EMMS-AS-100-...	1258793	EAMM-A-N48-80G
EMGA-80-P-G...-SAS-100		
s krokovým motorom a prevodovkou		
EMMS-ST-87-...	1258793	EAMM-A-N48-80G
EMGA-80-P-G...-SST-87		

motor/prevodovka	axiálna konštrukčná zostava	
typ	č. dielu	typ
ELGA-TB-...-120		
so servomotorom		
EMMS-AS-140-...	1201691	EAMM-A-N80-140A
so servomotorom a prevodovkou		
EMMS-AS-70-...	2372096	EAMM-A-N80-80G
EMGA-80-P-G...-SAS-70		
EMME-AS-80-...	2372096	EAMM-A-N80-80G
EMGA-80-P-G...-EAS-80		
EMME-AS-100-...	2372096	EAMM-A-N80-80G
EMGA-80-P-G...-SAS-100		
EMMS-AS-100-...	2372096	EAMM-A-N80-80G
EMGA-80-P-G...-SAS-100		
EMME-AS-100-...	1201695	EAMM-A-N80-120G
EMGA-120-P-G...-SAS-100		
EMMS-AS-100-...	1201695	EAMM-A-N80-120G
EMGA-120-P-G...-SAS-100		
EMMS-AS-140-...	1201695	EAMM-A-N80-120G
EMGA-120-P-G...-SAS-140		
s krokovým motorom a prevodovkou		
EMMS-ST-87-...	2372096	EAMM-A-N80-80G
EMGA-80-P-G...-SST-87		

Axiálne konštrukčné zostavy EAMM-A

prehľad dodávok

FESTO

Prípustné kombinácie os/motor s osou s ozubeným remeňom EGC-HD-TB

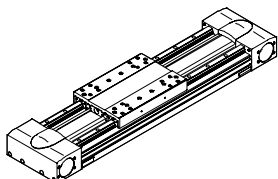

motor/prevodovka	axiálna konštrukčná zostava	
typ	č. dielu	typ
EGC-HD-125		
so servomotorom a prevodovkou		
EMMS-AS-55-...	1190076	EAMM-A-M43-60G
EMGA-60-P-G...-SAS-55		
EMMS-AS-70-...	1190076	EAMM-A-M43-60G
EMGA-60-P-G...-SAS-70		
s krokovým motorom a prevodovkou		
EMMS-ST-57-...	1190076	EAMM-A-M43-60G
EMGA-60-P-G...-SST-57		
EGC-HD-160		
so servomotorom a prevodovkou		
EMMS-AS-70-...	1190421	EAMM-A-M48-80G
EMGA-80-P-G...-SAS-70		
EMME-AS-80-...	1190421	EAMM-A-M48-80G
EMGA-80-P-G...-EAS-80		

motor/prevodovka	axiálna konštrukčná zostava	
typ	č. dielu	typ
EGC-HD-160		
so servomotorom a prevodovkou		
EMME-AS-100-...	1190421	EAMM-A-M48-80G
EMGA-80-P-G...-SAS-100		
EMMS-AS-100-...	1190421	EAMM-A-M48-80G
EMGA-80-P-G...-SAS-100		
s krokovým motorom a prevodovkou		
EMMS-ST-87-...	1190421	EAMM-A-M48-80G
EMGA-80-P-G...-SST-87		
EGC-HD-220		
so servomotorom a prevodovkou		
EMMS-AS-100-...	1190774	EAMM-A-M80-120G
EMGA-120-P-G...-SAS-100		
EMMS-AS-140-...	1190774	EAMM-A-M80-120G
EMGA-120-P-G...-SAS-140		

Prípustné kombinácie os/motor s osou s vretenom EGC-HD-BS

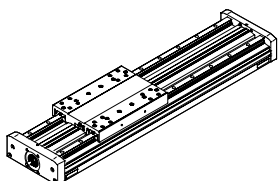

motor	axiálna konštrukčná zostava	
typ	č. dielu	typ
EGC-HD-125		
so servomotorom		
EMME-AS-40-...	2219044	EAMM-A-S38-40P
EMMS-AS-40-...	558162	EAMM-A-S38-40A
EMMS-AS-55-...	558163	EAMM-A-S38-55A
EMME-AS-60-...	2219110	EAMM-A-S38-60P
s krokovým motorom		
EMMS-ST-42-...	560685	EAMM-A-S38-42A
EMMS-ST-57-...	560686	EAMM-A-S38-57A
EGC-HD-160		
so servomotorom		
EMMS-AS-55-...	558164	EAMM-A-S48-55A
EMME-AS-60-...	2220560	EAMM-A-S48-60P
EMMS-AS-70-...	558165	EAMM-A-S48-70A
s krokovým motorom		
EMMS-ST-57-...	560687	EAMM-A-S48-57A
EMMS-ST-87-...	560688	EAMM-A-S48-87A

motor	axiálna konštrukčná zostava	
typ	č. dielu	typ
EGC-HD-220		
so servomotorom		
EMMS-AS-70-...	558166	EAMM-A-S62-70A
EMME-AS-80-...	2222582	EAMM-A-S62-80P
EMME-AS-100-...	558167	EAMM-A-S62-100A
EMMS-AS-100-...	558167	EAMM-A-S62-100A
EMMS-AS-140-...	558168	EAMM-A-S62-140A
s krokovým motorom		
EMMS-ST-87-...	560689	EAMM-A-S62-87A

Axiálne konštrukčné zostavy EAMM-A

prehľad dodávok

FESTO

Prípustné kombinácie os/motor s osou s minisuportom EGSL

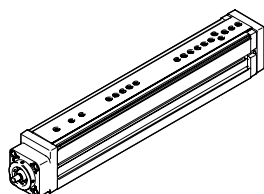

motor/prevodovka	axiálna konštrukčná zostava	
typ	č. dielu	typ
EGSL-35		
so servomotorom		
EMME-AS-40-...	1981953	EAMM-A-D19-40P
EMMS-AS-40-...	1199152	EAMM-A-D19-40A
s krokovým motorom		
EMMS-ST-28-...	1081659	EAMM-A-D19-28A
EMMS-ST-42-...	1087642	EAMM-A-D19-42A
EGSL-45		
so servomotorom		
EMME-AS-40-...	1976465	EAMM-A-D32-40P
EMMS-AS-40-...	543147	EAMM-A-D32-40A
EMMS-AS-55-...	550979	EAMM-A-D32-55A
EMME-AS-60-...	1956054	EAMM-A-D32-60P
s krokovým motorom		
EMMS-ST-42-...	543148	EAMM-A-D32-42A
EMMS-ST-57-...	550980	EAMM-A-D32-57A
EGSL-55		
so servomotorom		
EMMS-AS-55-...	543153	EAMM-A-D40-55A
EMME-AS-60-...	1977000	EAMM-A-D40-60P
EMMS-AS-70-...	550981	EAMM-A-D40-70A
so servomotorom a prevodovkou		
EMME-AS-40-...	560282	EAMM-A-D40-40G
EMGA-40-P-G...-EAS-40		
EMMS-AS-40-...	560282	EAMM-A-D40-40G
EMGA-40-P-G...-SAS-40		
s krokovým motorom		
EMMS-ST-57-...	543154	EAMM-A-D40-57A
EMMS-ST-87-...	550982	EAMM-A-D40-87A
s krokovým motorom a prevodovkou		
EMMS-ST-42-...	560282	EAMM-A-D40-40G
EMGA-40-P-G...-SST-42		

motor/prevodovka	axiálna konštrukčná zostava	
typ	č. dielu	typ
EGSL-75		
so servomotorom		
EMMS-AS-70-...	543161	EAMM-A-D60-70A
EMME-AS-80-...	1977073	EAMM-A-D60-80P
EMME-AS-100-...	550983	EAMM-A-D60-100A
EMMS-AS-100-...	550983	EAMM-A-D60-100A
so servomotorom a prevodovkou		
EMMS-AS-55-...	560283	EAMM-A-D60-60G
EMGA-60-P-G...-SAS-55		
EMME-AS-70-...	560283	EAMM-A-D60-60G
EMGA-60-P-G...-EAS-70		
s krokovým motorom		
EMMS-ST-87-...	543162	EAMM-A-D60-87A
s krokovým motorom a prevodovkou		
EMMS-ST-57-...	560283	EAMM-A-D60-60G
EMGA-60-P-G...-SST-57		

Axiálne konštrukčné zostavy EAMM-A

prehľad dodávok

FESTO

Prípustné kombinácie os/motor s elektrickým presným vedením s vretenom EGSK, EGSP

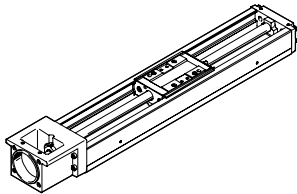

motor/prevodovka	axiálna konštrukčná zostava	
typ	č. dielu	typ
EGSK-15		
so servomotorom		
EMME-AS-40-...	1982886	EAMM-A-P3-28D-40P
s krokovým motorom		
EMMS-ST-28-...	1703478	EAMM-A-P3-28D-28A
EGSK-20/EGSP-20		
so servomotorom		
EMME-AS-40-...	1983071	EAMM-A-P4-28B-40P
EMMS-AS-40-...	562637	EAMM-A-P4-28B-40A
s krokovým motorom		
EMMS-ST-28-...	1731466	EAMM-A-P4-28B-28A
EMMS-ST-42-...	562636	EAMM-A-P4-28B-42A
EGSK-26/EGSP-26		
so servomotorom		
EMME-AS-40-...	1983122	EAMM-A-P5-28B-40P
EMMS-AS-40-...	562641	EAMM-A-P5-28B-40A
s krokovým motorom		
EMMS-ST-28-...	1731474	EAMM-A-P5-28B-28A
EMMS-ST-42-...	562640	EAMM-A-P5-28B-42A
EGSK-33		
so servomotorom		
EMME-AS-40-...	1983450	EAMM-A-P6-38A-40P
EMMS-AS-40-...	562646	EAMM-A-P6-38A-40A
EMMS-AS-55-...	562647	EAMM-A-P6-38A-55A
EMME-AS-60-...	2264375	EAMM-A-P6-38A-60P
s krokovým motorom		
EMMS-ST-42-...	562644	EAMM-A-P6-38A-42A
EMMS-ST-57-...	562645	EAMM-A-P6-38A-57A

motor/prevodovka	axiálna konštrukčná zostava	
typ	č. dielu	typ
EGSK-46/EGSP-33		
so servomotorom		
EMME-AS-40-...	1986292	EAMM-A-P8-38A-40P
EMMS-AS-40-...	562652	EAMM-A-P8-38A-40A
EMMS-AS-55-...	562653	EAMM-A-P8-38A-55A
EMME-AS-60-...	1987308	EAMM-A-P8-38A-60P
EMMS-AS-70-...	564996	EAMM-A-P8-38A-70A
s krokovým motorom		
EMMS-ST-42-...	562650	EAMM-A-P8-38A-42A
EMMS-ST-57-...	562651	EAMM-A-P8-38A-57A
EMMS-ST-87-...	564998	EAMM-A-P8-38A-87A
EGSP-46		
so servomotorom		
EMMS-AS-55-...	562659	EAMM-A-P10-38A-55A
EMME-AS-60-...	2036017	EAMM-A-P10-38A-60P
EMMS-AS-70-...	564997	EAMM-A-P10-38A-70A
s krokovým motorom		
EMMS-ST-57-...	562658	EAMM-A-P10-38A-57A
EMMS-ST-87-...	564999	EAMM-A-P10-38A-87A

Axiálne konštrukčné zostavy EAMM-A

prehľad dodávok

FESTO

Prípustné kombinácie os/motor s výložníkovou osou DGEA

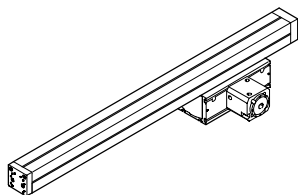

motor/prevodovka	axiálna konštrukčná zostava	
typ	č. dielu	typ
DGEA-18		
s krokovým motorom		
EMMS-ST-57-...	550956	EAMM-A-F28-57A
EMMS-ST-87-...	550958	EAMM-A-F28-87A
so servomotorom a prevodovkou		
EMMS-AS-55-...	550957	EAMM-A-F28-60G
EMGA-60-P-G...-SAS-55		
EMMS-AS-70-...	550957	EAMM-A-F28-60G
EMGA-60-P-G...-SAS-70		
s krokovým motorom a prevodovkou		
EMMS-ST-57-...	550957	EAMM-A-F28-60G
EMGA-60-P-G...-SST-57		
DGEA-25		
so servomotorom a prevodovkou		
EMMS-AS-55-...	550959	EAMM-A-F32-60G
EMGA-60-P-G...-SAS-55		
EMMS-AS-70-...	550959	EAMM-A-F32-60G
EMGA-60-P-G...-SAS-70		
s krokovým motorom		
EMMS-ST-87-...	550960	EAMM-A-F32-87A

motor/prevodovka	axiálna konštrukčná zostava	
typ	č. dielu	typ
DGEA-40		
so servomotorom a prevodovkou		
EMMS-AS-70-...	550935	EAMM-A-F40-80G
EMGA-80-P-G...-SAS-70		
EMME-AS-80-...	550935	EAMM-A-F40-80G
EMGA-80-P-G...-EAS-80		
EMME-AS-100-...	550935	EAMM-A-F40-80G
EMGA-80-P-G...-SAS-100		
EMMS-AS-100-...	550935	EAMM-A-F40-80G
EMGA-80-P-G...-SAS-100		
s krokovým motorom a prevodovkou		
EMMS-ST-87-...	550935	EAMM-A-F40-80G
EMGA-80-P-G...-SST-87		

Axiálne konštrukčné zostavy EAMM-A

prehľad dodávok

FESTO

Prípustné kombinácie os/motor s osou s ozubeným remeňom ELGG

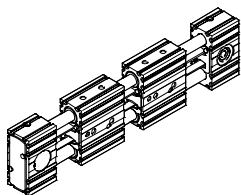

motor/prevodovka	axiálna konštrukčná zostava	
typ	č. dielu	typ
ELGG-35		
so servomotorom		
EMMS-AS-55-...	1133400	EAMM-A-R27-55A
s krokovým motorom		
EMMS-ST-57-...	1133403	EAMM-A-R27-57A
ELGG-45		
so servomotorom		
EMME-AS-60-...	2224996	EAMM-A-R38-60P
EMMS-AS-70-...	1133401	EAMM-A-R38-70A
s krokovým motorom		
EMMS-ST-57-...	1578138	EAMM-A-R38-57A
EMMS-ST-87-...	1133404	EAMM-A-R38-87A

motor/prevodovka	axiálna konštrukčná zostava	
typ	č. dielu	typ
ELGG-55		
so servomotorom		
EMMS-AS-70-...	1578139	EAMM-A-R48-70A
EMME-AS-80-...	2225090	EAMM-A-R48-80P
EMME-AS-100-...	1133402	EAMM-A-R48-100A
EMMS-AS-100-...	1133402	EAMM-A-R48-100A
s krokovým motorom		
EMMS-ST-87-...	1133405	EAMM-A-R48-87A

Prípustné kombinácie os/motor s osou s ozubeným remeňom ELGR

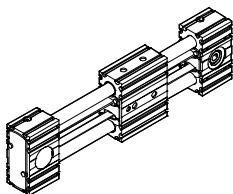

motor	axiálna konštrukčná zostava	
typ	č. dielu	typ
ELGR-35		
so servomotorom		
EMMS-AS-55-...	1133400	EAMM-A-R27-55A
s krokovým motorom		
EMMS-ST-57-...	1133403	EAMM-A-R27-57A
ELGR-45		
so servomotorom		
EMME-AS-60-...	2224996	EAMM-A-R38-60P
EMMS-AS-70-...	1133401	EAMM-A-R38-70A
s krokovým motorom		
EMMS-ST-57-...	1578138	EAMM-A-R38-57A
EMMS-ST-87-...	1133404	EAMM-A-R38-87A

motor	axiálna konštrukčná zostava	
typ	č. dielu	typ
ELGR-55		
so servomotorom		
EMMS-AS-70-...	1578139	EAMM-A-R48-70A
EMME-AS-80-...	2225090	EAMM-A-R48-80P
EMME-AS-100-...	1133402	EAMM-A-R48-100A
EMMS-AS-100-...	1133402	EAMM-A-R48-100A
s krokovým motorom		
EMMS-ST-87-...	1133405	EAMM-A-R48-87A

Axiálne konštrukčné zostavy EAMM-A

prehľad dodávok

FESTO

Prípustné kombinácie os/motor s rotačným modulom ERMB

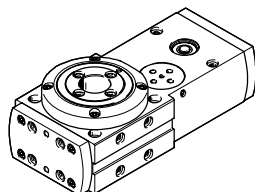

motor/prevodovka	axiálna konštrukčná zostava	
typ	č. dielu	typ
ERMB-20		
so servomotorom		
EMME-AS-40-...	2207441	EAMM-A-D32-35A-40P
EMMS-AS-40-...	560281	EAMM-A-D32-35A-40A
s krokovým motorom		
EMMS-ST-42-...	543148	EAMM-A-D32-42A
EMMS-ST-57-...	550980	EAMM-A-D32-57A
s motorovou jednotkou		
MTR-DCI-32S-...	543149	EAMM-A-D32-32B
ERMB-25		
so servomotorom		
EMMS-AS-55-...	543153	EAMM-A-D40-55A
EMME-AS-60-...	1977000	EAMM-A-D40-60P
EMMS-AS-70-...	550981	EAMM-A-D40-70A
so servomotorom a prevodovkou		
EMME-AS-40-...	560282	EAMM-A-D40-40G
EMGA-40-P-G...-EAS-40		
EMMS-AS-40-...	560282	EAMM-A-D40-40G
EMGA-40-P-G...-SAS-40		
s krokovým motorom		
EMMS-ST-57-...	543154	EAMM-A-D40-57A
s krokovým motorom a prevodovkou		
EMMS-ST-42-...	560282	EAMM-A-D40-40G
EMGA-40-P-G...-SST-42		
s motorovou jednotkou		
MTR-DCI-42S-...-G7	543155	EAMM-A-D40-42B
MTR-DCI-42S-...-G14	543156	EAMM-A-D40-42C

motor/prevodovka	axiálna konštrukčná zostava	
typ	č. dielu	typ
ERMB-32		
so servomotorom		
EMMS-AS-70-...	543161	EAMM-A-D60-70A
EMME-AS-80-...	1977073	EAMM-A-D60-80P
EMME-AS-100-...	550983	EAMM-A-D60-100A
EMMS-AS-100-...	550983	EAMM-A-D60-100A
so servomotorom a prevodovkou		
EMMS-AS-55-...	560283	EAMM-A-D60-60G
EMGA-60-P-G...-SAS-55		
EMMS-AS-70-...	560283	EAMM-A-D60-60G
EMGA-60-P-G...-SAS-70		
s krokovým motorom		
EMMS-ST-87-...	543162	EAMM-A-D60-87A
s krokovým motorom a prevodovkou		
EMMS-ST-57-...	560283	EAMM-A-D60-60G
EMGA-60-P-G...-SST-57		
s motorovou jednotkou		
MTR-DCI-52S-...-G7	543163	EAMM-A-D60-52B
MTR-DCI-52S-...-G14	543164	EAMM-A-D60-52C

Axiálne konštrukčné zostavy EAMM-A

prehľad dodávok

FESTO

Prípustné kombinácie os/motor s otočným zdvíhacím modulom EHMB

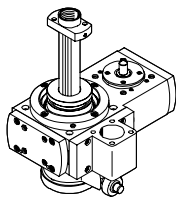

Pre otočný pohyb		
motor/prevodovka	axiálna konštrukčná zostava	
typ	č. dielu	typ
EHMB-20		
so servomotorom		
EMME-AS-40-...	2207441	EAMM-A-D32-35A-40P
EMMS-AS-40-...	560281	EAMM-A-D32-35A-40A
s krokovým motorom		
EMMS-ST-42-...	543148	EAMM-A-D32-42A
EMMS-ST-57-...	550980	EAMM-A-D32-57A
s motorovou jednotkou		
MTR-DCI-32S-...	543149	EAMM-A-D32-32B
EHMB-25		
so servomotorom		
EMMS-AS-55-...	543153	EAMM-A-D40-55A
EMME-AS-60-...	1977000	EAMM-A-D40-60P
EMMS-AS-70-...	550981	EAMM-A-D40-70A
so servomotorom a prevodovkou		
EMME-AS-40-...	560282	EAMM-A-D40-40G
EMGA-40-P-G...-EAS-40		
EMMS-AS-40-...	560282	EAMM-A-D40-40G
EMGA-40-P-G...-SAS-40		
s krokovým motorom		
EMMS-ST-57-...	543154	EAMM-A-D40-57A
s krokovým motorom a prevodovkou		
EMMS-ST-42-...	560282	EAMM-A-D40-40G
EMGA-40-P-G...-SST-42		
s motorovou jednotkou		
MTR-DCI-42S-...-G7	543155	EAMM-A-D40-42B
MTR-DCI-42S-...-G14	543156	EAMM-A-D40-42C

Pre otočný pohyb		
motor/prevodovka	axiálna konštrukčná zostava	
typ	č. dielu	typ
EHMB-32		
so servomotorom		
EMMS-AS-70-...	543161	EAMM-A-D60-70A
EMME-AS-80-...	1977073	EAMM-A-D60-80P
EMME-AS-100-...	550983	EAMM-A-D60-100A
EMMS-AS-100-...	550983	EAMM-A-D60-100A
so servomotorom a prevodovkou		
EMMS-AS-55-...	560283	EAMM-A-D60-60G
EMGA-60-P-G...-SAS-55		
EMMS-AS-70-...	560283	EAMM-A-D60-60G
EMGA-60-P-G...-SAS-70		
s krokovým motorom		
EMMS-ST-87-...	543162	EAMM-A-D60-87A
s krokovým motorom a prevodovkou		
EMMS-ST-57-...	560283	EAMM-A-D60-60G
EMGA-60-P-G...-SST-57		
s motorovou jednotkou		
MTR-DCI-52S-...-G7	543163	EAMM-A-D60-52B
MTR-DCI-52S-...-G14	543164	EAMM-A-D60-52C

Axiálne konštrukčné zostavy EAMM-A

údajový list

FESTO

materiál:

spojková skriňa, náboj spojky,

príruba motora: hliník

skrutky: pozinkovaná oceľ



Všeobecné technické údaje						
typ	pre os	krútiaci moment, ktorý spojka prenesie	hmotnostný moment zotrvačnosti	max. počet otáčok	hmotnosť	→ strana
		[Nm]	[kgmm ²]	[1/min]	[g]	
EAMM-A-D19-28A	EGSL	1,1	0,28	10000	80	32
EAMM-A-D19-40A	EGSL	1,1	0,28	10000	110	
EAMM-A-D19-42A	EGSL	1,1	0,28	10000	130	
EAMM-A-D19-40P	EGSL	1,1	0,28	10000	110	
EAMM-A-D32-32B	DNCE, EHMB, ERMB	1,1	0,28	10000	150	
EAMM-A-D32-40A	DNCE, EGSL	1,1	0,28	10000	130	
EAMM-A-D32-40P	DNCE, EGSL	1,1	0,28	10000	160	
EAMM-A-D32-35A-40A	EHMB, ERMB	4	5,87	8000	220	
EAMM-A-D32-35A-40P	EHMB, ERMB	4	5,87	8000	160	
EAMM-A-D32-42A	DNCE, EGSL, EHMB, ERMB	0,8	0,3	10000	140	
EAMM-A-D32-55A	DNCE, EGSL, EHMB	4	5,87	8000	260	
EAMM-A-D32-57A	DNCE, EGSL, EHMB, ERMB	4	5,87	8000	270	
EAMM-A-D32-60P	DNCE, EGSL, EHMB, ERMB	4	5,87	8000	410	
EAMM-A-D40-40G	DNCE, EHMB, ERMB, EGSL	8	5,87	8000	350	
EAMM-A-D40-42B	DNCE, EHMB, ERMB	8	5,87	8000	340	
EAMM-A-D40-42C	DNCE, EHMB, ERMB	8	5,87	8000	370	
EAMM-A-D40-55A	DNCE, EGSL, EHMB, ERMB	8	5,87	8000	350	
EAMM-A-D40-57A	DNCE, EGSL, EHMB, ERMB	6	5,87	8000	350	
EAMM-A-D40-60P	DNCE, EGSL, EHMB, ERMB	8	5,87	8000	430	
EAMM-A-D40-70A	DNCE, EGSL, EHMB, ERMB	8	5,87	8000	410	
EAMM-A-D40-87A	DNCE, EGSL, EHMB, ERMB	8	5,87	8000	530	
EAMM-A-D60-52B	DNCE, EHMB, ERMB	14	34,8	6000	930	
EAMM-A-D60-52C	DNCE, EHMB, ERMB	14	34,8	6000	1020	
EAMM-A-D60-60G	DNCE, EHMB, ERMB, ESBF, EGSL	12	34,8	6000	830	
EAMM-A-D60-70A	DNCE, EGSL, EHMB, ERMB, ESBF	12	34,8	6000	750	
EAMM-A-D60-80P	DNCE, EGSL, EHMB, ERMB, ESBF	14	34,8	6000	1040	
EAMM-A-D60-87A	DNCE, EGSL, EHMB, ERMB, ESBF	12	34,8	6000	890	
EAMM-A-D60-100A	DNCE, EGSL, EHMB, ERMB, ESBF	14	34,8	6000	1170	
EAMM-A-D80-100A	ESBF	60	128	5500	2030	
EAMM-A-D80-140A	ESBF	60	128	5500	2920	
EAMM-A-D100-140A	ESBF	143	280	4500	3460	

Axiálne konštrukčné zostavy EAMM-A

údajový list

FESTO

Všeobecné technické údaje						
typ	pre os	krútiaci moment, ktorý spojka prenesie [Nm]	hmotnostný moment zotrvačnosti [kgmm ²]	max. počet otáčok [1/min]	hmotnosť [g]	→ strana
EAMM-A-E20-32B	DMES	1,5	0,23	10000	100	30
EAMM-A-E20-40A	DGE-SP, DMES	1	0,13	12000	80	
EAMM-A-E20-42A	DGE-SP, DMES	1	0,13	12000	100	
EAMM-A-E20-55A	DGE-SP, DMES	1	0,13	12000	140	
EAMM-A-E32-40A	DGE-SP, DMES	7,5	6,1	8000	250	
EAMM-A-E32-42B	DMES	6,5	5,87	8000	340	
EAMM-A-E32-42C	DMES	6,5	5,87	8000	380	
EAMM-A-E32-55A	DGE-SP, DMES	7,5	6,1	8000	280	
EAMM-A-E32-57A	DGE-SP, DMES	7,5	6,1	8000	290	
EAMM-A-E48-52B	DMES	17	34,8	6000	1120	
EAMM-A-E48-52C	DMES	17	34,8	6000	1210	
EAMM-A-E48-55A	DGE-SP	8,5	6,1	8000	530	
EAMM-A-E48-57A	DGE-SP	7,5	6,1	8000	540	
EAMM-A-E48-44A-70A	DGE-SP	9,2	6,1	8000	600	
EAMM-A-E48-64A-70A	DMES	17	42,3	6500	790	
EAMM-A-E48-87A	DGE-SP, DMES	17	42,3	6500	1500	
EAMM-A-E48-100A	DGE-SP, DMES	17	42,3	6500	1280	
EAMM-A-E48-40G	DGE-SP	8,8	6,1	8000	550	
EAMM-A-E72-62B	DMES	17	35,5	6000	2800	
EAMM-A-E72-70A	DGE-SP, DMES	17	42,3	6500	2370	
EAMM-A-E72-87A	DGE-SP, DMES	17	42,3	6500	3040	
EAMM-A-E72-100A	DGE-SP, DMES	17	42,3	6500	3240	
EAMM-A-E72-60G	DGE-SP DMES	17	42,3	6500	3190	
EAMM-A-E72-80G	DGE-SP, DMES	17	42,3	6500	3190	
EAMM-A-F28-57A	DGEA	7,5	6,1	8000	280	49
EAMM-A-F28-60G	DGEA	8,2	6,1	8000	350	
EAMM-A-F28-87A	DGEA	8,2	6,1	8000	450	
EAMM-A-F30-55A	DGE-ZR	8,2	6,1	8000	270	26
EAMM-A-F30-57A	DGE-ZR	7,5	6,1	8000	280	
EAMM-A-F30-60G	DGE-ZR	8,2	6,1	8000	410	
EAMM-A-F30-70A	DGE-ZR	8,2	6,1	8000	330	
EAMM-A-F30-87A	DGE-ZR	8,2	6,1	8000	440	
EAMM-A-F32-60G	DGEA	17	42,3	6500	920	49
EAMM-A-F32-87A	DGEA	17	42,3	6500	770	
EAMM-A-F37-55A	DGE-ZR	8,2	6,1	8000	270	26
EAMM-A-F37-57A	DGE-ZR	7,5	6,1	8000	270	
EAMM-A-F37-70A	DGE-ZR	8,2	6,1	8000	330	
EAMM-A-F37-87A	DGE-ZR	8,2	6,1	8000	480	
EAMM-A-F37-60G	DGE-ZR	8,2	6,1	8000	350	
EAMM-A-F40-70A	DGE-ZR	17	42,3	6500	640	
EAMM-A-F40-80G	DGE-ZR, DGEA	17	42,3	6500	890	49

Axiálne konštrukčné zostavy EAMM-A

údajový list

FESTO

Všeobecné technické údaje						
typ	pre os	krútiaci moment, ktorý spojka prenesie [Nm]	hmotnostný moment zotrvačnosti [kgmm ²]	max. počet otáčok [1/min]	hmotnosť [g]	→ strana
EAMM-A-F40-87A	DGE-ZR	17	42,3	6500	790	26
EAMM-A-F40-100A	DGE-ZR	17	42,3	6500	940	
EAMM-A-F40-80G	DGE-ZR	17	42,3	6500	890	
EAMM-A-F47-87A	DGE-ZR	17	42,3	6500	780	
EAMM-A-F47-100A	DGE-ZR	17	42,3	6500	1010	
EAMM-A-F47-140A	DGE-ZR	17	42,3	6500	1 930	
EAMM-A-F47-80G	DGE-ZR	17	42,3	6500	1000	
EAMM-A-F62-100A	DGE-ZR	85	417	4500	2540	
EAMM-A-F62-140A	DGE-ZR	92	417	4500	2780	
EAMM-A-F62-80G	DGE-ZR	85	417	4500	2760	
EAMM-A-F62-120G	DGE-ZR	92	417	4500	2480	
EAMM-A-F80-100A	DGE-ZR	85	417	4500	2560	
EAMM-A-F80-140A	DGE-ZR	92	417	4500	2 640	
EAMM-A-F80-80G	DGE-ZR	85	417	4500	2810	
EAMM-A-F80-120G	DGE-ZR	92	417	4500	2730	
EAMM-A-F80-160G	DGE-ZR	92	417	4500	5240	
EAMM-A-G13-40A	DGE-ZR	1	0,13	12000	80	
EAMM-A-G13-42A	DGE-ZR	1	0,13	12000	90	
EAMM-A-G16-40A	DGE-ZR	1	0,13	12000	80	
EAMM-A-G16-42A	DGE-ZR	1	0,13	12000	120	
EAMM-A-G16-55A	DGE-ZR	1	0,13	12000	140	
EAMM-A-G19-40A	DGE-ZR	1,5	0,47	8000	160	
EAMM-A-G19-55A	DGE-ZR	1,5	0,47	8000	190	
EAMM-A-G19-57A	DGE-ZR	1,5	0,47	8000	200	
EAMM-A-L27-55A	EGC-TB	2	0,445	10000	220	38
EAMM-A-L27-57A	EGC-TB	1,6	0,355	10000	180	
EAMM-A-L27-40G	EGC-TB	2	0,445	10000	180	
EAMM-A-L38-57A	EGC-TB	3,6	3,2	8000	220	
EAMM-A-L38-60G	EGC-TB	4,4	3,2	8000	350	
EAMM-A-L38-60P	EGC-TB	4,4	3,3	8000	300	
EAMM-A-L38-70A	EGC-TB	4,4	3,2	8000	290	
EAMM-A-L38-87A	EGC-TB	4,4	3,2	8000	480	
EAMM-A-L48-70A	EGC-TB	12,5	14,5	8000	350	
EAMM-A-L48-80P	EGC-TB	17	39	6000	660	
EAMM-A-L48-87A	EGC-TB	12,5	14,5	8000	590	
EAMM-A-L48-100A	EGC-TB	17	39	6000	990	
EAMM-A-L48-60G	EGC-TB	12,5	14,5	8000	490	
EAMM-A-L62-100A	EGC-TB	47	147	5500	1610	
EAMM-A-L62-140A	EGC-TB	47	147	5500	2420	
EAMM-A-L62-80G	EGC-TB	47	147	5500	1620	
EAMM-A-L95-140A	EGC-TB	143	374	4500	3710	
EAMM-A-L95-190A	EGC-TB	192	374	4500	5280	
EAMM-A-L95-120G	EGC-TB	150	374	4500	3660	

Axiálne konštrukčné zostavy EAMM-A

údajový list

FESTO

Všeobecné technické údaje							
typ	pre os	krútiaci moment, ktorý spojka prenesie [Nm]	hmotnostný moment zotrvačnosti [kgmm ²]	max. počet otáčok [1/min]	hmotnosť [g]	→ strana	
EAMM-A-M43-60G	EGC-HD-TB	12,5	14,5	8000	340	43	
EAMM-A-M48-80G	EGC-HD-TB	21	39	6000	870		
EAMM-A-M80-120G	EGC-HD-TB	75	147	5500	1370		
EAMM-A-N38-70A	ELGA	12,5	14,5	8000	430	42	
EAMM-A-N38-60G	ELGA	12,5	14,5	8000	470		
EAMM-A-N48-100A	ELGA	17	39	6000	1070		
EAMM-A-N48-80G	ELGA	17	39	6000	1080		
EAMM-A-N80-80G	ELGA	60	147	5500	1290		
EAMM-A-N80-120G	ELGA	60	147	5500	1990		
EAMM-A-N80-140A	ELGA	60	147	5500	2070		
EAMM-A-S38-40A	EGC-BS, EGC-HD-BS	6,5	5,87	8000	370		40, 44
EAMM-A-S38-40P	EGC-BS, EGC-HD-BS	6,5	5,87	8000	380		
EAMM-A-S38-42A	EGC-BS, EGC-HD-BS	3,5	5,87	8000	410		
EAMM-A-S38-55A	EGC-BS, EGC-HD-BS	6,5	5,87	8000	400		
EAMM-A-S38-57A	EGC-BS, EGC-HD-BS	6,5	5,87	8000	400		
EAMM-A-S38-60P	EGC-BS, EGC-HD-BS	6,5	5,87	8000	530		
EAMM-A-S48-55A	EGC-BS, EGC-HD-BS	12,5	5,87	8000	590		
EAMM-A-S48-57A	EGC-BS, EGC-HD-BS	6,5	5,87	8000	580		
EAMM-A-S48-60P	EGC-BS, EGC-HD-BS	12,5	5,87	8000	580		
EAMM-A-S48-70A	EGC-BS, EGC-HD-BS	12,5	5,87	8000	610		
EAMM-A-S48-87A	EGC-BS, EGC-HD-BS	12,5	5,87	8000	760		
EAMM-A-S62-70A	EGC-BS, EGC-HD-BS	17	45,5	6000	1950		
EAMM-A-S62-80P	EGC-BS, EGC-HD-BS	17	34,8	6000	1890		
EAMM-A-S62-87A	EGC-BS, EGC-HD-BS	17	45,5	6000	2070		
EAMM-A-S62-100A	EGC-BS, EGC-HD-BS	17	34,8	6000	2050		
EAMM-A-S62-140A	EGC-BS, EGC-HD-BS	17	34,8	6000	2870		
EAMM-A-S95-100A	EGC-BS	60	128	5500	4910		
EAMM-A-S95-140A	EGC-BS	60	128	5500	5500		

Axiálne konštrukčné zostavy EAMM-A

údajový list

FESTO

Všeobecné technické údaje						
typ	pre os	krútiaci moment, ktorý spojka prenesie [Nm]	hmotnostný moment zotrvačnosti [kgmm ²]	max. počet otáčok [1/min]	hmotnosť [g]	→ strana
EAMM-A-P3-28D-28A	EGSK	0,2	0,28	10000	30	46
EAMM-A-P3-28D-40P	EGSK	0,2	0,28	10000	60	
EAMM-A-P4-28B-28A	EGSK, EGSP	0,7	0,28	10000	40	
EAMM-A-P4-28B-40A	EGSK, EGSP	0,7	0,28	10000	50	
EAMM-A-P4-28B-40P	EGSK, EGSP	0,7	0,28	10000	50	
EAMM-A-P4-28B-42A	EGSK, EGSP	0,7	0,28	10000	60	
EAMM-A-P5-28B-28A	EGSK, EGSP	1,1	0,28	10000	40	
EAMM-A-P5-28B-40A	EGSK, EGSP	1,1	0,28	10000	50	
EAMM-A-P5-28B-40P	EGSK, EGSP	1,1	0,28	10000	50	
EAMM-A-P5-28B-42A	EGSK, EGSP	1,1	0,28	10000	60	
EAMM-A-P6-38A-40A	EGSK, EGSP	6,5	5,87	8000	100	
EAMM-A-P6-38A-40P	EGSK	6,5	5,87	8000	110	
EAMM-A-P6-38A-42A	EGSK, EGSP	3,5	5,87	8000	160	
EAMM-A-P6-38A-55A	EGSK, EGSP	6,5	5,87	8000	130	
EAMM-A-P6-38A-57A	EGSK, EGSP	6,5	5,87	8000	130	
EAMM-A-P6-38A-60P	EGSK	6,5	5,87	8000	210	
EAMM-A-P8-38A-40A	EGSK, EGSP	6,5	5,87	8000	100	
EAMM-A-P8-38A-40P	EGSK, EGSP	12,5	5,87	8000	110	
EAMM-A-P8-38A-42A	EGSK, EGSP	3,5	5,87	8000	160	
EAMM-A-P8-38A-55A	EGSK, EGSP	12,5	5,87	8000	130	
EAMM-A-P8-38A-57A	EGSK, EGSP	6,5	5,87	8000	130	
EAMM-A-P8-38A-60P	EGSK, EGSP	12,5	5,87	8000	210	
EAMM-A-P8-38A-70A	EGSK, EGSP	12,5	5,87	8000	200	
EAMM-A-P8-38A-87A	EGSK, EGSP	12,5	5,87	8000	380	
EAMM-A-P10-38A-55A	EGSK, EGSP	12,5	5,87	8000	130	
EAMM-A-P10-38A-57A	EGSK, EGSP	6,5	5,87	8000	130	
EAMM-A-P10-38A-60P	EGSP	12,5	5,87	8000	210	
EAMM-A-P10-38A-70A	EGSK, EGSP	12,5	5,87	8000	200	
EAMM-A-P10-38A-87A	EGSK, EGSP	12,5	5,87	8000	380	
EAMM-A-R27-55A	ELGG, ELGR	2	0,445	10000	170	48
EAMM-A-R27-57A	ELGG, ELGR	1,6	0,355	10000	170	
EAMM-A-R38-57A	ELGG, ELGR	3,6	3,2	8000	280	
EAMM-A-R38-60P	ELGG, ELGR	4,4	3,3	8000	350	
EAMM-A-R38-70A	ELGG, ELGR	4,4	3,2	8000	350	
EAMM-A-R38-87A	ELGG, ELGR	4,4	3,2	8000	530	
EAMM-A-R48-70A	ELGG, ELGR	12,5	14,5	8000	450	
EAMM-A-R48-80P	ELGG, ELGR	17	39	6000	710	
EAMM-A-R48-87A	ELGG, ELGR	12,5	14,5	8000	590	
EAMM-A-R48-100A	ELGG, ELGR	17	39	6000	970	

Axiálne konštrukčné zostavy EAMM-A

údajový list

FESTO

Prevádzkové podmienky a podmienky okolia		
teplota okolia	[°C]	−10 ... +60
skladovacia teplota	[°C]	−25 ... +60
krytie ¹⁾		
EAMM-A-...		IP40
EAMM-A-...-S1		IP65
relatívna vlhkosť vzduchu	[%]	0 ... 95
odolnosť proti korózii KBK ²⁾		1
poznámka o materiáli		v zmysle RoHS

1) iba v kombinácii s namontovaným motorom a osou

2) Trieda odolnosti proti korózii 1 podľa normy Festo 940 070

Konštrukčné diely s nízkymi nárokmi na odolnosť proti korózii. Ochrana pri preprave a skladovaní. Diely bez požiadaviek na vzhľad povrchu, určené napr. do skrytých vnútorných priestorov alebo zadné kryty.

Axiálne konštrukčné zostavy EAMM-A

údajový list

FESTO

Rozmery a typové označenie

stahovanie CAD modelov → www.festo.sk/engineering

DGE-ZR-...

EAMM-A-G-...

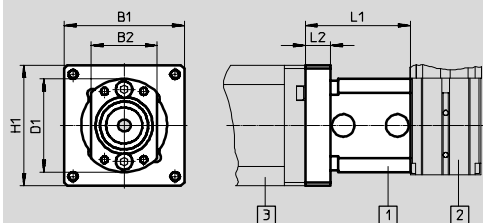

EAMM-A-F-...

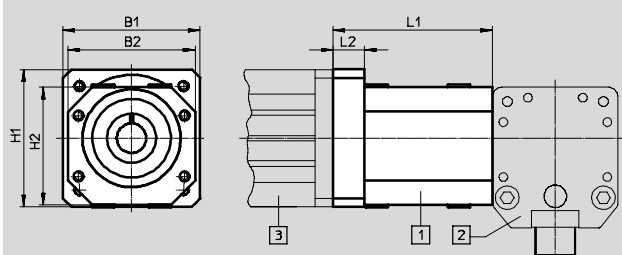

základná schéma:

- 1 axiálna konštrukčná zostava
- 2 os s ozubeným remeňom
- 3 motor

typ	B1	B2	H1	H2	L1	L2
EAMM-A-F30-55A	55	45	55	45	51,4	10,5
EAMM-A-F30-57A	56,4	45	56,4	45	52,7	12
EAMM-A-F30-70A	70	45	70	45	54,2	13,5
EAMM-A-F30-87A	85,8	45	85,8	45	56,2	15,5
EAMM-A-F30-60G	60	45	60	45	60,7	20
EAMM-A-F37-55A	55	45	55	45	51,4	15
EAMM-A-F37-57A	56,4	45	56,4	45	52,7	10
EAMM-A-F37-70A	70	45	70	45	54,2	14,5
EAMM-A-F37-87A	85,8	45	85,8	45	56,2	19
EAMM-A-F37-60G	60	45	60	45	60,7	11,5
EAMM-A-F40-70A	70	65	70	60	81,2	16
EAMM-A-F40-87A	85,8	65	85,8	60	82,7	17,5
EAMM-A-F40-100A	100	65	100	60	86,2	21
EAMM-A-F40-80G	90	65	90	60	89,4	24
EAMM-A-F47-87A	85,8	65	85,8	60	82,7	12,5
EAMM-A-F47-100A	100	65	100	60	86,2	5
EAMM-A-F47-140A	138	65	138	60	95,2	10,5
EAMM-A-F47-80G	90	65	90	60	89,4	8,3

Axiálne konštrukčné zostavy EAMM-A



údajový list

typ	B1	B2	D1	H1	H2	L1	L2
EAMM-A-F62-100A	100	100	–	105	100	116,2	25
EAMM-A-F62-140A	138	100	–	138	100	111,2	20
EAMM-A-F62-80G	115	100	–	115	100	119,2	28
EAMM-A-F62-120G	115	100	–	115	100	119,2	28
EAMM-A-F80-100A	100	100	–	105	100	116,2	21
EAMM-A-F80-140A	138	100	–	138	100	111,2	12
EAMM-A-F80-80G	115	100	–	115	100	119,2	12
EAMM-A-F80-120G	115	100	–	115	100	119,2	10,5
EAMM-A-F80-160G	160	100	–	160	100	151,2	21
EAMM-A-G13-40A	40	22	29	40	–	33,9	8,3
EAMM-A-G13-42A	42	22	29	42	–	42,2	16,5
EAMM-A-G16-40A	40	22	31	40	–	34,9	8,3
EAMM-A-G16-42A	42	22	31	42	–	42,4	18
EAMM-A-G16-55A	55	22	31	55	–	37,7	11
EAMM-A-G19-40A	48	31	44,5	48	–	38,5	9,5
EAMM-A-G19-55A	55	31	44,5	55	–	39,7	10,5
EAMM-A-G19-57A	56,4	31	44,5	56,4	–	41	12

Axiálne konštrukčné zostavy EAMM-A

údajový list

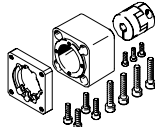
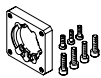

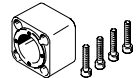

FESTO

Jednotlivé diely – typové označenie			
axiálna konštrukčná zostava	zloženie:		
	príruba motora	spojka	teleso spojky
			
č. dielu typ	č. dielu typ	č. dielu typ	č. dielu typ
550929 EAMM-A-F30-55A	529942 EAMF-A-44A/B-55A	557390 EAMC-30-35-8-9	124628 EAMK-A-F30-44A
550930 EAMM-A-F30-57A	530081 EAMF-A-44A/B-57A	530088 EAMC-30-35-6,35-8	124628 EAMK-A-F30-44A
550932 EAMM-A-F30-70A	529943 EAMF-A-44A/B-70A	123042 EAMC-30-35-8-11	124628 EAMK-A-F30-44A
550933 EAMM-A-F30-87A	530082 EAMF-A-44A/B-87A	123042 EAMC-30-35-8-11	124628 EAMK-A-F30-44A
550931 EAMM-A-F30-60G	529944 EAMF-A-44A/B-60G	123042 EAMC-30-35-8-11	124628 EAMK-A-F30-44A
550942 EAMM-A-F37-55A	529942 EAMF-A-44A/B-55A	557390 EAMC-30-35-8-9	534394 EAMK-A-F37-44A/C
550943 EAMM-A-F37-57A	530081 EAMF-A-44A/B-57A	530088 EAMC-30-35-6,35-8	534394 EAMK-A-F37-44A/C
550945 EAMM-A-F37-70A	529943 EAMF-A-44A/B-70A	123042 EAMC-30-35-8-11	534394 EAMK-A-F37-44A/C
550946 EAMM-A-F37-87A	530082 EAMF-A-44A/B-87A	123042 EAMC-30-35-8-11	534394 EAMK-A-F37-44A/C
550944 EAMM-A-F37-60G	529944 EAMF-A-44A/B-60G	123042 EAMC-30-35-8-11	534394 EAMK-A-F37-44A/C
550934 EAMM-A-F40-70A	529945 EAMF-A-64A/B-70A	550998 EAMC-40-66-11-15	124629 EAMK-A-F40-64A
550936 EAMM-A-F40-87A	533140 EAMF-A-64A/B-87A	550998 EAMC-40-66-11-15	124629 EAMK-A-F40-64A
550937 EAMM-A-F40-100A	529947 EAMF-A-64A/C/D-100A	123844 EAMC-40-66-15-19	124629 EAMK-A-F40-64A
550935 EAMM-A-F40-80G	533139 EAMF-A-64A/C-80G	123845 EAMC-40-66-15-20	124629 EAMK-A-F40-64A
550948 EAMM-A-F47-87A	533140 EAMF-A-64A/B-87A	550998 EAMC-40-66-11-15	534395 EAMK-A-F47-64A
550949 EAMM-A-F47-100A	529947 EAMF-A-64A/C/D-100A	123844 EAMC-40-66-15-19	534395 EAMK-A-F47-64A
550950 EAMM-A-F47-140A	550988 EAMF-A-64A-140A	176033 EAMC-40-66-15-24	534395 EAMK-A-F47-64A
550947 EAMM-A-F47-80G	533139 EAMF-A-64A/C-80G	123845 EAMC-40-66-15-20	534395 EAMK-A-F47-64A

Axiálne konštrukčné zostavy EAMM-A

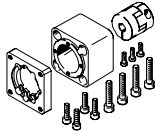
údajový list

FESTO

Jednotlivé diely			
axiálna konštrukčná zostava	zloženie:		
	príruba motora	spojka	teleso spojky
			
č. dielu typ	č. dielu typ	č. dielu typ	č. dielu typ
550939 EAMM-A-F62-100A	529949 EAMF-A-118C-100A	551000 EAMC-65-90-19-25	124630 EAMK-A-F62-118A/B/C
550941 EAMM-A-F62-140A	550991 EAMF-A-118B-140A	123852 EAMC-65-90-24-25	124630 EAMK-A-F62-118A/B/C
550938 EAMM-A-F62-80G	550989 EAMF-A-118A-80G	176035 EAMC-65-90-20-25	124630 EAMK-A-F62-118A/B/C
550940 EAMM-A-F62-120G	550990 EAMF-A-118A-120G	123853 EAMC-65-90-25-25	124630 EAMK-A-F62-118A/B/C
550952 EAMM-A-F80-100A	529949 EAMF-A-118C-100A	551000 EAMC-65-90-19-25	534396 EAMK-A-F80-118A/B/C
550954 EAMM-A-F80-140A	550991 EAMF-A-118B-140A	123852 EAMC-65-90-24-25	534396 EAMK-A-F80-118A/B/C
550951 EAMM-A-F80-80G	550989 EAMF-A-118A-80G	176035 EAMC-65-90-20-25	534396 EAMK-A-F80-118A/B/C
550953 EAMM-A-F80-120G	550990 EAMF-A-118A-120G	123853 EAMC-65-90-25-25	534396 EAMK-A-F80-118A/B/C
550955 EAMM-A-F80-160G	550992 EAMF-A-118A-160G	551001 EAMC-65-90-25-40	534396 EAMK-A-F80-118A/B/C
550921 EAMM-A-G13-40A	540301 EAMF-A-28A/30A-40A	540750 EAMC-B-15-22-4-6	171186 EAMK-A-G13-28A
550922 EAMM-A-G13-42A	530080 EAMF-A-28A-42A	530084 EAMC-B-15-22-4-5	171186 EAMK-A-G13-28A
550923 EAMM-A-G16-40A	540301 EAMF-A-28A/30A-40A	540750 EAMC-B-15-22-4-6	171185 EAMK-A-G16-30A
550924 EAMM-A-G16-42A	530079 EAMF-A-30A-42A	530084 EAMC-B-15-22-4-5	171185 EAMK-A-G16-30A
550925 EAMM-A-G16-55A	534807 EAMF-A-30A-55A	184262 EAMC-B-15-22-4-9	171185 EAMK-A-G16-30A
550926 EAMM-A-G19-40A	550985 EAMF-A-44A/B-40A	184265 EAMC-B-19-24-6-6	170375 EAMK-A-G19-44B
550927 EAMM-A-G19-55A	529942 EAMF-A-44A/B-55A	184263 EAMC-B-19-24-6-9	170375 EAMK-A-G19-44B
550928 EAMM-A-G19-57A	530081 EAMF-A-44A/B-57A	530086 EAMC-B-19-24-6-6,35	170375 EAMK-A-G19-44B

Axiálne konštrukčné zostavy EAMM-A

údajový list

FESTO

Rozmery a údaje pre objednávku

stahovanie CAD modelov → www.festo.sk/engineering

DGE-SP-...

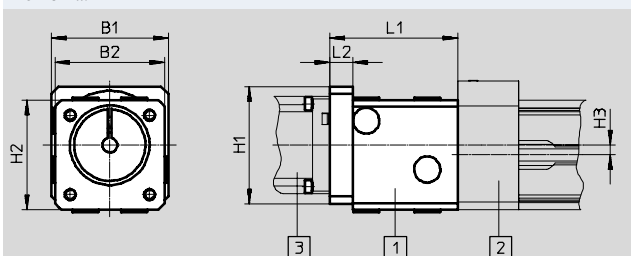

základná schéma:

- 1 axiálna konštrukčná zostava
- 2 os s vretenom
- 3 motor

DMES-...

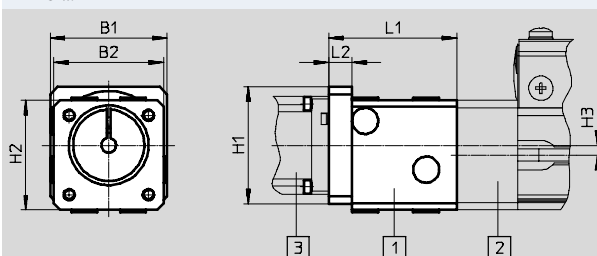

základná schéma:

- 1 axiálna konštrukčná zostava
- 2 polohovacia os
- 3 motor

typ	B1	B2	H1	H2	H3	L1	L2
EAMM-A-E20-32B	–	33,6	–	41	–	27 –0,2	7
EAMM-A-E20-40A	40	33,5	40	31,5	–	27,5	8,3
EAMM-A-E20-42A	42	33,5	42	31,5	–	35,7	5
EAMM-A-E20-55A	55	33,5	55	31,5	–	29,5	10,5
EAMM-A-E32-40A	48	45	48	45	4	52,5	9,5
EAMM-A-E32-42B	–	44,8	–	54,4	4	88	23
EAMM-A-E32-42C	–	44,8	–	54,4	4	101	36
EAMM-A-E32-55A	55	45	55	45	4	53,7	10,5
EAMM-A-E32-57A	56,4	45	56,4	45	4	55	12
EAMM-A-E48-52B	–	63,8	–	76,4	5	121	25
EAMM-A-E48-52C	–	63,8	–	76,4	5	135	39
EAMM-A-E48-55A	55	64 –0,3	55	64 –0,3	5	57,2	10,5
EAMM-A-E48-57A	56,4	64 –0,3	56,4	64 –0,3	5	58,5	12
EAMM-A-E48-44A-70A	70	64 –0,3	70	64 –0,3	5	60	13,5
EAMM-A-E48-64A-70A	70	65 –0,3	70	64 –0,3	5	86,2	16
EAMM-A-E48-87A	85,8	65 –0,3	85,8	64 –0,3	5	87,7	17,5
EAMM-A-E48-100A	100	65 –0,3	100	64 –0,3	5	91,2	21
EAMM-A-E48-40G	50	64 –0,3	50	64 –0,3	5	63,5	17
EAMM-A-E72-62B	–	105,1	–	127,3	8	150	34
EAMM-A-E72-70A	70	105,6	70	114,8	8	98,7	16
EAMM-A-E72-87A	85,8	105,6	85,8	114,8	8	100,2	17,5
EAMM-A-E72-100A	100	105,6	100	114,8	8	103,7	21
EAMM-A-E72-60G	70	105,6	70	114,8	8	106,9	24,4
EAMM-A-E72-80G	90	105,6	90	114,8	8	106,9	24

Axiálne konštrukčné zostavy EAMM-A

údajový list

FESTO

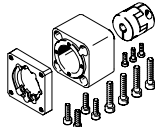
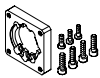
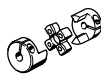
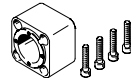
Jednotlivé diely			
axiálna konštrukčná zostava	zloženie:		
	príruba motora	spojka	teleso spojky
			
č. dielu typ	č. dielu typ	č. dielu typ	č. dielu typ
556991 EAMM-A-E20-32B	–	533707 EAMC-15-20-5-6	533703 EAMK-A-E20-32B
550961 EAMM-A-E20-40A	552163 EAMF-A-28B-40A	540751 EAMC-B-15-22-5-6	170374 EAMK-A-E20-28B
550962 EAMM-A-E20-42A	552164 EAMF-A-28B-42A	530085 EAMC-B-15-22-5-5	170374 EAMK-A-E20-28B
550963 EAMM-A-E20-55A	529946 EAMF-A-28A/B-55A	529953 EAMC-B-15-22-5-9	170374 EAMK-A-E20-28B
550964 EAMM-A-E32-40A	550985 EAMF-A-44A/B-40A	123040 EAMC-30-35-6-6	124631 EAMK-A-E32-44A
556992 EAMM-A-E32-42B	–	533708 EAMC-30-32-6-8	533704 EAMK-A-E32-42B
556993 EAMM-A-E32-42C	–	533708 EAMC-30-32-6-8	538578 EAMK-A-E32-42C
550965 EAMM-A-E32-55A	529942 EAMF-A-44A/B-55A	530941 EAMC-30-35-6-9	124631 EAMK-A-E32-44A
550966 EAMM-A-E32-57A	530081 EAMF-A-44A/B-57A	530087 EAMC-30-35-6-6,35	124631 EAMK-A-E32-44A
556994 EAMM-A-E48-52B	–	533709 EAMC-42-50-12-12	533705 EAMK-A-E48-52B
556995 EAMM-A-E48-52C	–	533709 EAMC-42-50-12-12	538579 EAMK-A-E48-52C
550969 EAMM-A-E48-55A	529942 EAMF-A-44A/B-55A	550996 EAMC-30-35-9-12	124632 EAMK-A-E48-44A
550970 EAMM-A-E48-57A	530081 EAMF-A-44A/B-57A	550995 EAMC-30-35-6,35-12	124632 EAMK-A-E48-44A
550971 EAMM-A-E48-44A-70A	529943 EAMF-A-44A/B-70A	123051 EAMC-30-35-11-12	124632 EAMK-A-E48-44A
557448 EAMM-A-E48-64A-70A	529945 EAMF-A-64A/B-70A	525864 EAMC-40-66-11-12	529940 EAMK-A-E48-64A
550972 EAMM-A-E48-87A	533140 EAMF-A-64A/B-87A	525864 EAMC-40-66-11-12	529940 EAMK-A-E48-64A
550973 EAMM-A-E48-100A	529947 EAMF-A-64A/C/D-100A	529952 EAMC-40-66-12-19	529940 EAMK-A-E48-64A
550968 EAMM-A-E48-40G	550986 EAMF-A-44A/B-40G	552640 EAMC-30-35-10-12	124632 EAMK-A-E48-44A
556996 EAMM-A-E72-62B	–	533710 EAMC-42-50-14-20	533706 EAMK-A-E72-62B
550975 EAMM-A-E72-70A	529945 EAMF-A-64A/B-70A	550999 EAMC-40-66-11-20	529941 EAMK-A-E72-64A
550977 EAMM-A-E72-87A	533140 EAMF-A-64A/B-87A	550999 EAMC-40-66-11-20	529941 EAMK-A-E72-64A
550978 EAMM-A-E72-100A	529947 EAMF-A-64A/C/D-100A	123847 EAMC-40-66-19-20	529941 EAMK-A-E72-64A
550974 EAMM-A-E72-60G	550987 EAMF-A-64A/B-60G/H	550999 EAMC-40-66-11-20	529941 EAMK-A-E72-64A
550976 EAMM-A-E72-80G	533139 EAMF-A-64A/C-80G	123849 EAMC-40-66-20-20	529941 EAMK-A-E72-64A

Axiálne konštrukčné zostavy EAMM-A

údajový list

FESTO

Rozmery a údaje pre objednávku

sťahovanie CAD modelov → www.festo.sk/engineering

EGSL...

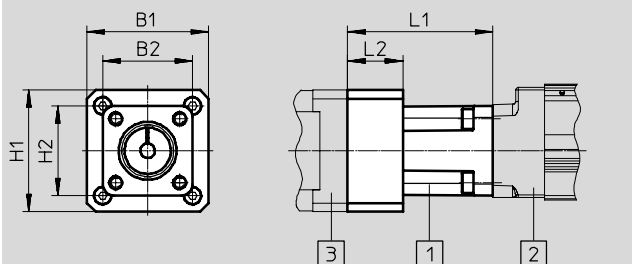

základná schéma:

- 1 axiálna konštrukčná zostava
- 2 minisoparty
- 3 motor

DNCE... s krytím IP40

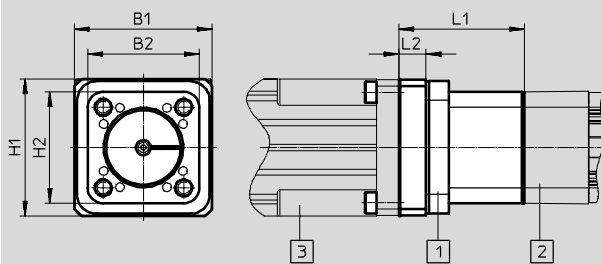

základná schéma:

- 1 axiálna konštrukčná zostava
- 2 elektrický valec
- 3 motor

ESBF... s krytím IP40

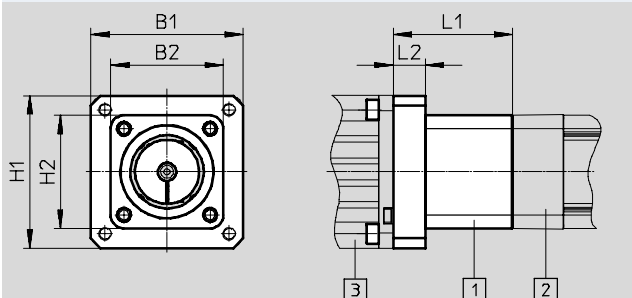

základná schéma:

- 1 axiálna konštrukčná zostava
- 2 elektrický valec
- 3 motor

ERMB...

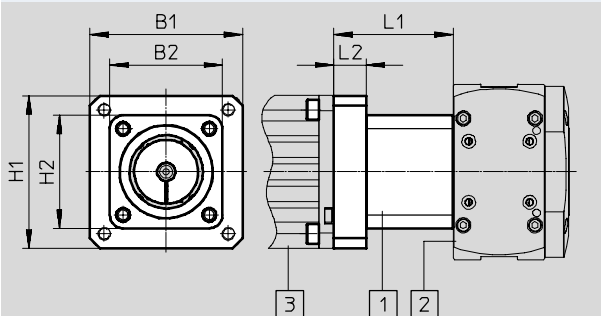

základná schéma:

- 1 axiálna konštrukčná zostava
- 2 rotačný modul
- 3 motor

EHMB...

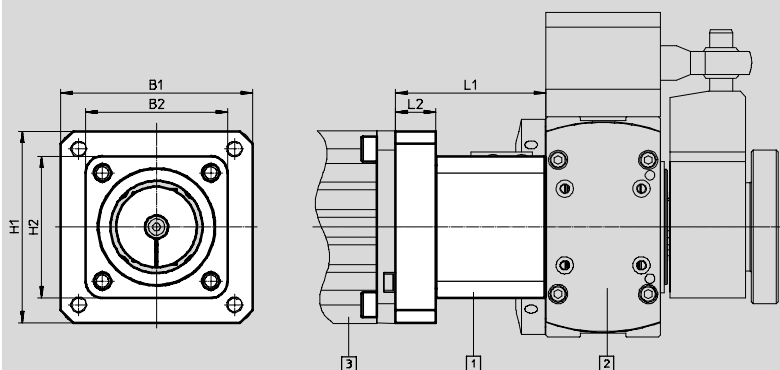

základná schéma:

- 1 axiálna konštrukčná zostava
- 2 rotačno-zdvihový modul
- 3 motor

Axiálne konštrukčné zostavy EAMM-A

údajový list



FESTO

typ	B1	B2	H1	H2	L1	L2
EAMM-A-D19-28A	30	31	30	31	46,2	15
EAMM-A-D19-40A	40	31	40	31	42,7	11,5
EAMM-A-D19-40P	39,7	31	39,7	31	45,7	14,5
EAMM-A-D19-42A	42	31	42	31	50	19
EAMM-A-D32-32B	33,6	45	41	45	43	-
EAMM-A-D32-35A-40A	35	31	35	31	41,2	10
EAMM-A-D32-35A-40P	40	31	40	31	42,7	11,5
EAMM-A-D32-40A	40	45	40	45	39,8	8,3
EAMM-A-D32-40P	39,7	45	39,7	45	44	12,5
EAMM-A-D32-42A	42	45	42	45	48	5
EAMM-A-D32-55A	55	45	55	45	49,2	10,5
EAMM-A-D32-57A	56,4	65	56,4	45	50,5	12
EAMM-A-D32-60P	61,4	65	61,4	45	59,7	21
EAMM-A-D40-40G	50	53,5	50	53,5	55,5	17
EAMM-A-D40-42B	44,8	53,5	54,4	53,5	88	9
EAMM-A-D40-42C	44,8	53,5	54,4	53,5	101	9
EAMM-A-D40-55A	55	53,5	55	53,5	49,2	10,5
EAMM-A-D40-57A	56,4	53,5	56,4	53,5	50,5	12
EAMM-A-D40-60P	61,4	53,5	61,4	53,5	59,7	21
EAMM-A-D40-70A	70	53,5	70	53,5	52	13,5
EAMM-A-D40-87A	85,8	53,5	85,8	53,5	54	15,5
EAMM-A-D60-52B	63,8	74	76,4	74	112	13
EAMM-A-D60-52C	63,8	74	76,4	74	126	13
EAMM-A-D60-60G	70	74	70	74	71,4	24
EAMM-A-D60-70A	70	74	70	74	63,2	16
EAMM-A-D60-80P	81,3	74	81,3	74	74,7	17,5
EAMM-A-D60-87A	85,8	74	85,8	74	64,7	17,5
EAMM-A-D60-100A	100	74	100	74	78,2	21
EAMM-A-D80-100A	100	97,2	100	97,2	92	20
EAMM-A-D80-140A	140,5	97,2	140,5	97,2	102	30
EAMM-A-D100-140A	140,5	109	140,5	109	109,5	30

Axiálne konštrukčné zostavy EAMM-A

údajový list

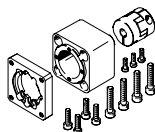
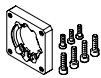

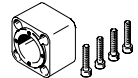
FESTO

Jednotlivé diely			
axiálna konštrukčná zostava	zloženie:		
	príruba motora	spojka	teleso spojky
			
č. dielu typ	č. dielu typ	č. dielu typ	č. dielu typ
1081659 EAMM-A-D19-28A	1087613 EAMF-A-28D-28A	562676 EAMC-16-20-5-5	1087585 EAMK-A-D19-28D
1199152 EAMM-A-D19-40A	1199144 EAMF-A-28D-40A	543419 EAMC-16-20-5-6	1087585 EAMK-A-D19-28D
1981953 EAMM-A-D19-40P	1982014 EAMF-A-28D-40P	562677 EAMC-16-20-5-8	1087585 EAMK-A-D19-28D
1087642 EAMM-A-D19-42A	1087630 EAMF-A-28D-42A	562676 EAMC-16-20-5-5	1087585 EAMK-A-D19-28D
543149 EAMM-A-D32-32B	–	543420 EAMC-16-20-6-6	552156 EAMK-A-D32-32B
560281 EAMM-A-D32-35A-40A	–	558312 EAMC-30-32-6-6	560280 EAMK-A-D32-35-40A
2207441 EAMM-A-D32-35A-40P	–	533708 EAMC-30-32-6-8	2207509 EAMK-A-D32-35A-40P
543147 EAMM-A-D32-40A	552163 EAMF-A-28B-40A	543420 EAMC-16-20-6-6	552155 EAMK-A-D32-28B
1976465 EAMM-A-D32-40P	1976704 EAMF-A-28B-40P	1232854 EAMC-16-20-6-8	552155 EAMK-A-D32-28B
543148 EAMM-A-D32-42A	552164 EAMF-A-28B-42A	543419 EAMC-16-20-5-6	552155 EAMK-A-D32-28B
550979 EAMM-A-D32-55A	529942 EAMF-A-44A/B-55A	551003 EAMC-30-32-6-9	551006 EAMK-A-D32-44A/C
550980 EAMM-A-D32-57A	530081 EAMF-A-44A/B-57A	551002 EAMC-30-32-6-6,35	551006 EAMK-A-D32-44A/C
1956054 EAMM-A-D32-60P	1956846 EAMF-A-44C-60P	1233256 EAMC-30-32-6-14	551006 EAMK-A-D32-44A/C

Axiálne konštrukčné zostavy EAMM-A

údajový list

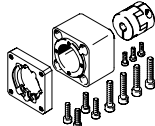
FESTO

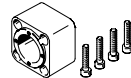
Jednotlivé diely			
axiálna konštrukčná zostava	zloženie:		
	príruba motora	spojka	teleso spojky
			
č. dielu typ	č. dielu typ	č. dielu typ	č. dielu typ
560282 EAMM-A-D40-40G	550986 EAMF-A-44A/B-40G	558029 EAMC-30-32-8-10	552157 EAMK-A-D40-44A/C
543155 EAMM-A-D40-42B	–	543422 EAMC-30-32-8-8	522158 EAMK-A-D40-42B
543156 EAMM-A-D40-42C	–	543422 EAMC-30-32-8-8	522159 EAMK-A-D40-42C
543153 EAMM-A-D40-55A	529942 EAMF-A-44A/B-55A	543423 EAMC-30-32-8-9	552157 EAMK-A-D40-44A/C
543154 EAMM-A-D40-57A	530081 EAMF-A-44A/B-57A	543421 EAMC-30-32-6,35-8	552157 EAMK-A-D40-44A/C
1977000 EAMM-A-D40-60P	1956846 EAMF-A-44C-60P	562682 EAMC-30-32-8-14	552157 EAMK-A-D40-44A/C
550981 EAMM-A-D40-70A	529943 EAMF-A-44A/B-70A	551004 EAMC-30-32-8-11	552157 EAMK-A-D40-44A/C
550982 EAMM-A-D40-87A	530082 EAMF-A-44A/B-87A	551004 EAMC-30-32-8-11	552157 EAMK-A-D40-44A/C
543163 EAMM-A-D60-52B	–	533709 EAMC-42-50-12-12	552161 EAMK-A-D60-52B
543164 EAMM-A-D60-52C	–	533709 EAMC-42-50-12-12	552162 EAMK-A-D60-52C
560283 EAMM-A-D60-60G	550987 EAMF-A-64A/B-60G/H	543424 EAMC-42-50-11-12	552160 EAMK-A-D60-64B
543161 EAMM-A-D60-70A	529945 EAMF-A-64A/B-70A	543424 EAMC-42-50-11-12	552160 EAMK-A-D60-64B
1977073 EAMM-A-D60-80P	1977113 EAMF-A-64A/C-80P	551005 EAMC-42-50-12-19	551007 EAMK-A-D60-64C
543162 EAMM-A-D60-87A	533140 EAMF-A-64A/B-87A	543424 EAMC-42-50-11-12	552160 EAMK-A-D60-64B
550983 EAMM-A-D60-100A	529947 EAMF-A-64A/C/D-100A	551005 EAMC-42-50-12-19	551007 EAMK-A-D60-64C
1589665 EAMM-A-D80-100A	1593628 EAMF-A-77A-100A	1485673 EAMC-56-58-19-19	1593627 EAMK-A-D80-77A
1588299 EAMM-A-D80-140A	1593636 EAMF-A-77A-140A	1485674 EAMC-56-58-19-24	1593627 EAMK-A-D80-77A
1588349 EAMM-A-D100-140A	1593636 EAMF-A-77A-140A	1451407 EAMC-67-62-24-24	1593914 EAMK-A-D100-77A/B

Axiálne konštrukčné zostavy EAMM-A

údajový list

FESTO

Rozmery a údaje pre objednávku

sťahovanie CAD modelov → www.festo.sk/engineering

DNCE... s krytím IP65

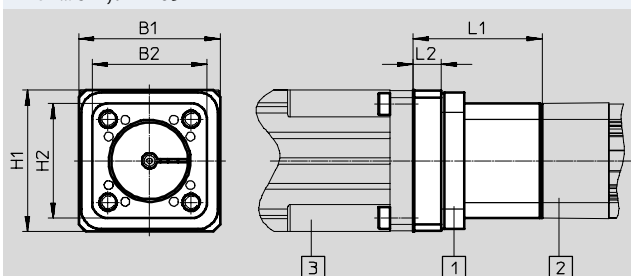

základná schéma:

- 1 axiálna konštrukčná zostava
- 2 elektrický valec
- 3 motor

ESBF... s krytím IP65

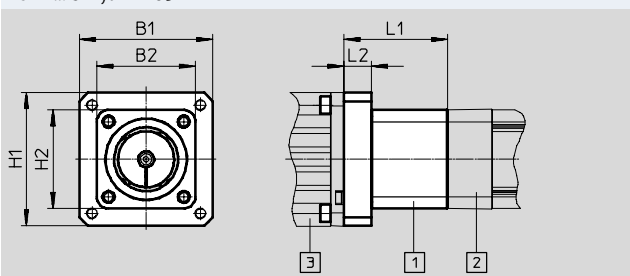

základná schéma:

- 1 axiálna konštrukčná zostava
- 2 elektrický valec
- 3 motor

typ	B1	B2	H1	H2	L1	L2
EAMM-A-D32-40P-S1	39,7	45	39,7	45	45,5	13
EAMM-A-D32-40A-S1	40	45	40	45	41,3	8,8
EAMM-A-D32-42A-S1	42	45	42	45	49,5	5,5
EAMM-A-D32-55A-S1	55	45	55	45	50,7	11
EAMM-A-D32-57A-S1	56,4	45	56,4	45	52	12,5
EAMM-A-D40-55A-S1	55	53,5	55	53,5	50,7	11
EAMM-A-D40-57A-S1	56,4	53,5	56,4	53,5	52	12,5
EAMM-A-D40-70A-S1	70	53,5	70	53,5	53,5	14
EAMM-A-D40-87A-S1	85,8	53,5	85,8	53,5	55,5	16
EAMM-A-D60-80P-S1	81,3	74	81,3	74	75,7	18
EAMM-A-D60-70A-S1	70	74	70	74	65	16,5
EAMM-A-D60-87A-S1	85,8	74	85,8	74	66,5	18
EAMM-A-D60-100A-S1	100	74	100	74	80	21,5
EAMM-A-D60-70A-S1	70	74	70	74	65	16,5
EAMM-A-D60-100A-S1	100	74	100	74	80	21,5
EAMM-A-D80-100A-S1	100	97,2	100	97,2	93,5	20,5
EAMM-A-D80-140A-S1	140,5	97,2	140,5	97,2	103,5	30,5
EAMM-A-D100-140A-S1	140,5	109	140,5	109	111	30,5

Axiálne konštrukčné zostavy EAMM-A

údajový list

FESTO

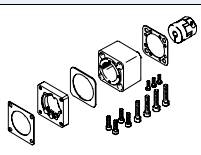
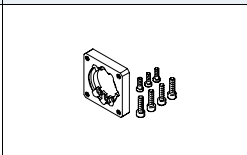
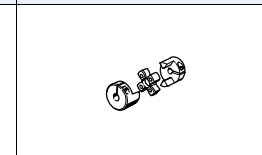
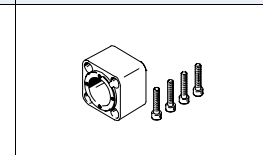
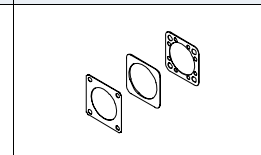
Jednotlivé diely				
axiálna konštrukčná zostava	zloženie:			
	príruba motora	spojka	teleso spojky	sada tesnení
				
č. dielu typ	č. dielu typ	č. dielu typ	č. dielu typ	č. dielu typ
2207372 EAMM-A-D32-40P-S1	1976704 EAMF-A-28B-40P	1232854 EAMC-16-20-6-8	552155 EAMK-A-D32-28B	2207219 EADS-F-D32-40P
1322178 EAMM-A-D32-40A-S1	552163 EAMF-A-28B-40A	543420 EAMC-16-20-6-6	552155 EAMK-A-D32-28B	1561526 EADS-F-D32-40A
1322179 EAMM-A-D32-42A-S1	552164 EAMF-A-28B-42A	543419 EAMC-16-20-5-6	552155 EAMK-A-D32-28B	1561527 EADS-F-D32-42A
1322180 EAMM-A-D32-55A-S1	529942 EAMF-A-44A/B-55A	551003 EAMC-30-32-6-9	551006 EAMK-A-D32-44A/C	1561528 EADS-F-D32-55A
1322181 EAMM-A-D32-57A-S1	530081 EAMF-A-44A/B-57A	551002 EAMC-30-32-6-6,35	551006 EAMK-A-D32-44A/C	1561529 EADS-F-D32-57A
1322182 EAMM-A-D40-55A-S1	529942 EAMF-A-44A/B-55A	543423 EAMC-30-32-8-9	552157 EAMK-A-D40-44A/C	1561530 EADS-F-D40-55A
1322183 EAMM-A-D40-57A-S1	530081 EAMF-A-44A/B-57A	543421 EAMC-30-32-6,35-8	552157 EAMK-A-D40-44A/C	1561531 EADS-F-D40-57A
1322185 EAMM-A-D40-70A-S1	529943 EAMF-A-44A/B-70A	551004 EAMC-30-32-8-11	552157 EAMK-A-D40-44A/C	1561532 EADS-F-D40-70A
1322186 EAMM-A-D40-87A-S1	530082 EAMF-A-44A/B-87A	551004 EAMC-30-32-8-11	552157 EAMK-A-D40-44A/C	1561533 EADS-F-D40-87A
2218564 EAMM-A-D60-80P-S1	1977113 EAMF-A-64A/C-80P	551005 EAMC-42-50-12-19	551007 EAMK-A-D60-64C	2218523 EADS-F-D60-80P
1322187 EAMM-A-D60-70A-S1	529945 EAMF-A-64A/B-70A	543424 EAMC-42-50-11-12	552160 EAMK-A-D60-64B	8022145 EADS-F-D60-70A
1322188 EAMM-A-D60-87A-S1	533140 EAMF-A-64A/B-87A	543424 EAMC-42-50-11-12	552160 EAMK-A-D60-64B	1561536 EADS-F-D60-87A
1322190 EAMM-A-D60-100A-S1	529947 EAMF-A-64A/C/D-100A	551005 EAMC-42-50-12-19	551007 EAMK-A-D60-64C	2253507 EADS-F-D60-100A
1679566 EAMM-A-D60-70A-S1	529945 EAMF-A-64A/B-70A	543424 EAMC-42-50-11-12	552160 EAMK-A-D60-64B	8022145 EADS-F-D60-70A
1679518 EAMM-A-D60-100A-S1	529947 EAMF-A-64A/C/D-100A	551005 EAMC-42-50-12-19	551007 EAMK-A-D60-64C	2253507 EADS-F-D60-100A
1600673 EAMM-A-D80-100A-S1	1593628 EAMF-A-77A-100A	1485673 EAMC-56-58-19-19	1593627 EAMK-A-D80-77A	1593617 EADS-F-D80-100A
1600674 EAMM-A-D80-140A-S1	1593636 EAMF-A-77A-140A	1485674 EAMC-56-58-19-24	1593627 EAMK-A-D80-77A	1593671 EADS-F-D80-140A
1600675 EAMM-A-D100-140A-S1	1593636 EAMF-A-77A-140A	1451407 EAMC-67-62-24-24	1593914 EAMK-A-D100-77A/B	1593991 EADS-F-D100-140A

Axiálne konštrukčné zostavy EAMM-A

údajový list

FESTO

Rozmery a údaje pre objednávku

stahovanie CAD modelov → www.festo.sk/engineering

EGC-TB...

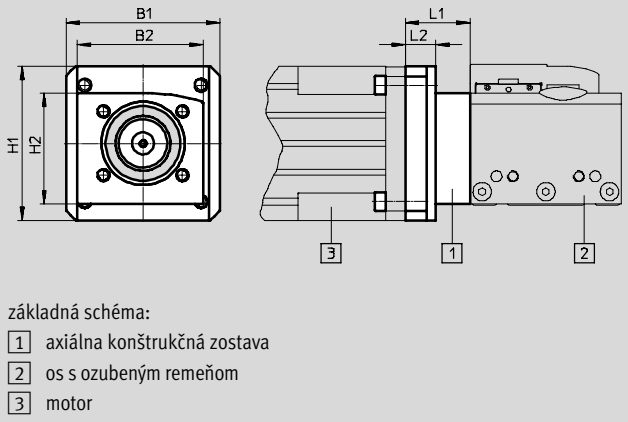

typ	B1	B2	H1	H2	L1	L2
EAMM-A-L27-55A	55	40	55	55	23,1	–
EAMM-A-L27-57A	56	39,5	56	56	23,1	–
EAMM-A-L27-40G	50	40	50	50	28,7	–
EAMM-A-L38-57A	56	57,5	56	50,3	26,7	11
EAMM-A-L38-60G	60	57,5	60	50,3	41,7	26
EAMM-A-L38-60P	61,4	57,5	61,4	50,3	36,7	21
EAMM-A-L38-70A	70	57,5	70	50,3	29,5	13,8
EAMM-A-L38-87A	85,8	57,5	85,8	50,3	33,7	18
EAMM-A-L48-70A	70	65	70	61	40,2	12,2
EAMM-A-L48-80P	81,3	65	81,3	61	54	26
EAMM-A-L48-87A	85,8	65	85,8	61	44	16
EAMM-A-L48-100A	100,5	65	100,5	61	59	31
EAMM-A-L48-60G	60	65	60	61	52,5	24,5
EAMM-A-L62-100A	100,5	100	100,5	90,5	62,5	14,5
EAMM-A-L62-140A	140	100	140	90,5	72,5	24,5
EAMM-A-L62-80G	100	100	100	90,5	62,5	14,5
EAMM-A-L95-140A	140	140	140	142,5	76	27
EAMM-A-L95-190A	190	140	190	142,5	86	37
EAMM-A-L95-120G	124	140	124	142,5	81	32





Jednotlivé diely

axiálna konštrukčná zostava		zloženie:			
		príruba motora	spojka	teleso spojky	konštrukčná zostava skrutiek
č. dielu typ	č. dielu typ	č. dielu typ	č. dielu typ	č. dielu typ	č. dielu typ
557975 EAMM-A-L27-55A	558016 EAMF-A-L27-55A	557999 EAMD-19-15-9-8X10	–	–	–
560678 EAMM-A-L27-57A	560690 EAMF-A-L27-57A	561292 EAMD-16-15-6,35-8X10	–	–	–
557974 EAMM-A-L27-40G	558015 EAMF-A-L27-40G	557998 EAMD-19-15-10-8X10	–	–	–
560679 EAMM-A-L38-57A	560692 EAMF-A-38A-57A	561293 EAMD-25-22-6,35-10X12	558011 EAMK-A-L38-38A	567484 EAHM-L2-M5-30	
557978 EAMM-A-L38-60G	558017 EAMF-A-38A-60G/H	558000 EAMD-25-22-11-10X12	558011 EAMK-A-L38-38A	567485 EAHM-L2-M5-35	
2037246 EAMM-A-L38-60P	1987412 EAMF-A-38A-60P	1453861 EAMD-28-22-14-10X12	558011 EAMK-A-L38-38A	567485 EAHM-L2-M5-35	
557979 EAMM-A-L38-70A	558018 EAMF-A-38A-70A	558000 EAMD-25-22-11-10X12	558011 EAMK-A-L38-38A	567484 EAHM-L2-M5-30	
560680 EAMM-A-L38-87A	560693 EAMF-A-38A-87A	558000 EAMD-25-22-11-10X12	558011 EAMK-A-L38-38A	567485 EAHM-L2-M5-35	

Axiálne konštrukčné zostavy EAMM-A

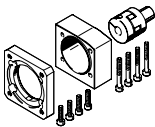
údajový list

FESTO

Jednotlivé diely				
axiálna konštrukčná zostava	zloženie:			
	príruba motora	spojka	teleso spojky	konštrukčná zostava skrutiek
				
č. dielu typ	č. dielu typ	č. dielu typ	č. dielu typ	č. dielu typ
557982 EAMM-A-L48-70A	558025 EAMF-A-48A-70A	558001 EAMD-32-32-11-16X20	558012 EAMK-A-L48-48A	567486 EAHM-L2-M5-40
2042616 EAMM-A-L48-80P	2043427 EAMF-A-48A-80P	558002 EAMD-42-40-19-16X25	558012 EAMK-A-L48-48A	567489 EAHM-L2-M5-55
560683 EAMM-A-L48-87A	560695 EAMF-A-48A-87A	558001 EAMD-32-32-11-16X20	558012 EAMK-A-L48-48A	567487 EAHM-L2-M5-45
557984 EAMM-A-L48-100A	558020 EAMF-A-48A-100A	558002 EAMD-42-40-19-16X25	558012 EAMK-A-L48-48A	567489 EAHM-L2-M5-55
557983 EAMM-A-L48-60G	558019 EAMF-A-48A-60G/H	558001 EAMD-32-32-11-16X20	558012 EAMK-A-L48-48A	567486 EAHM-L2-M5-40
557988 EAMM-A-L62-100A	558026 EAMF-A-62A-100A	558003 EAMD-56-46-19-23X27	558013 EAMK-A-L62-62A	567491 EAHM-L2-M6-65
557990 EAMM-A-L62-140A	558022 EAMF-A-62A-140A	558005 EAMD-56-46-24-23X27	558013 EAMK-A-L62-62A	567493 EAHM-L2-M6-70
557989 EAMM-A-L62-80G	558021 EAMF-A-62A-80G	558004 EAMD-56-46-20-23X27	558013 EAMK-A-L62-62A	567492 EAHM-L2-M6-65-L
557994 EAMM-A-L95-140A	558023 EAMF-A-95A-140A	558008 EAMD-67-51-24-32X32-U	558014 EAMK-A-L95-95A	567497 EAHM-L2-M8-80
1378474 EAMM-A-L95-190A	1378473 EAMF-A-95A-190A	1379269 EAMD-67-51-32-32X32-U	558014 EAMK-A-L95-95A	567497 EAHM-L2-M8-80
557995 EAMM-A-L95-120G	558024 EAMF-A-95A-120G	558006 EAMD-67-51-25-32X32-U	558014 EAMK-A-L95-95A	567496 EAHM-L2-M8-70

Axiálne konštrukčné zostavy EAMM-A

údajový list

FESTO

Rozmery a údaje pre objednávku

stahovanie CAD modelov → www.festo.sk/engineering

EGC-BS...

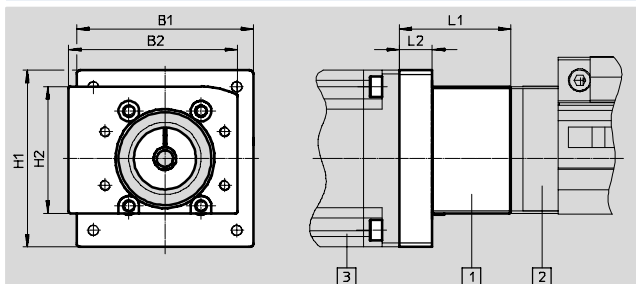

základná schéma:

- 1 axiálna konštrukčná zostava
- 2 os s vretenom
- 3 motor



typ	B1	B2	H1	H2	L1	L2
EAMM-A-S38-40A	58	69	44	50	44	7
EAMM-A-S38-40P	58	69	44	50	54	15,5
EAMM-A-S38-42A	58	69	44	50	52	15
EAMM-A-S38-55A	55	69	55	50	48	11
EAMM-A-S38-57A	56	69	56	50	48	11
EAMM-A-S38-60P	61,4	69	61,4	50	63,2	16
EAMM-A-S48-55A	70	82	55	61,5	47,2	9,2
EAMM-A-S48-57A	70	82	55	61,5	47,2	9,2
EAMM-A-S48-60P	61,4	82	61,4	61,5	74,7	17,5
EAMM-A-S48-70A	70	82	70	61,5	50,2	12,2
EAMM-A-S48-87A	85,8	82	85,8	61,5	54	16
EAMM-A-S62-70A	82	120	70	88,5	78,5	12
EAMM-A-S62-80P	81,3	120	81,3	88,5	64,7	17,5
EAMM-A-S62-87A	85,8	120	85,8	88,5	81,5	15
EAMM-A-S62-100A	100,5	120	100,5	88,5	81	14,5
EAMM-A-S62-140A	140	120	140	88,5	91	24,5
EAMM-A-S95-100A	140	186	100	140,5	85,5	17
EAMM-A-S95-140A	140	186	140	140,5	95,5	27

Jednotlivé diely				
axiálna konštrukčná zostava		zloženie:		
	príruba motora	spojka	teleso spojky	konštrukčná zostava skrutiek
č. dielu typ	č. dielu typ	č. dielu typ	č. dielu typ	č. dielu typ
558162 EAMM-A-S38-40A	558175 EAMF-A-38B-40A	558312 EAMC-30-32-6-6	558171 EAMK-A-S38-38A/B	-
2219044 EAMM-A-S38-40P	2219077 EAMF-A-38B-40P	533708 EAMC-30-32-6-8	558171 EAMK-A-S38-38A/B	-
560685 EAMM-A-S38-42A	560691 EAMF-A-38B-42A	561333 EAMC-30-32-5-6	558171 EAMK-A-S38-38A/B	-
558163 EAMM-A-S38-55A	558176 EAMF-A-38A-55A	551003 EAMC-30-32-6-9	558171 EAMK-A-S38-38A/B	567488 EAHM-L2-M5-50
560686 EAMM-A-S38-57A	560692 EAMF-A-38A-57A	551002 EAMC-30-32-6-6,35	558171 EAMK-A-S38-38A/B	567488 EAHM-L2-M5-50
2219110 EAMM-A-S38-60P	1987412 EAMM-A-38A-60P	1233256 EAMC-30-32-6-14	558171 EAMK-A-S38-38A/B	567489 EAHM-L2-M5-55
558164 EAMM-A-S48-55A	558177 EAMF-A-48B-55A	543423 EAMC-30-32-8-9	558172 EAMK-A-S48-48A/B	-
560687 EAMM-A-S48-57A	560694 EAMF-A-48B-57A	543421 EAMC-30-32-6,35-8	558172 EAMK-A-S48-48A/B	-
2220560 EAMM-A-S48-60P	2220620 EAMF-A-48A-60P	562682 EAMC-30-32-8-14	558172 EAMK-A-S48-48A/B	567489 EAHM-L2-M5-55
558165 EAMM-A-S48-70A	558025 EAMF-A-48A-70A	551004 EAMC-30-32-8-11	558172 EAMK-A-S48-48A/B	567488 EAHM-L2-M5-50
560688 EAMM-A-S48-87A	560695 EAMF-A-48A-87A	551004 EAMC-30-32-8-11	558172 EAMK-A-S48-48A/B	567489 EAHM-L2-M5-55

Axiálne konštrukčné zostavy EAMM-A

údajový list

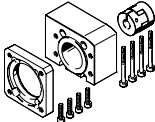
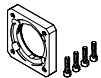
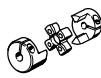
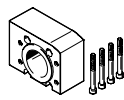
FESTO

Jednotlivé diely				
axiálna konštrukčná zostava	zloženie:			
	príruba motora	spojka	teleso spojky	konštrukčná zostava skrutiek
				
č. dielu typ	č. dielu typ	č. dielu typ	č. dielu typ	č. dielu typ
558166 EAMM-A-S62-70A	558179 EAMF-A-62B-70A	558313 EAMC-42-66-11-12	558173 EAMK-A-S62-62A/B	-
2222582 EAMM-A-S62-80P	2222624 EAMF-A-62B-80P	551005 EAMC-42-50-12-19	558173 EAMK-A-S62-62A/B	-
560689 EAMM-A-S62-87A	560696 EAMF-A-62B-87A	558313 EAMC-42-66-11-12	558173 EAMK-A-S62-62A/B	-
558167 EAMM-A-S62-100A	558026 EAMF-A-62A-100A	551005 EAMC-42-50-12-19	558173 EAMK-A-S62-62A/B	567494 EAHM-L2-M6-80
558168 EAMM-A-S62-140A	558022 EAMF-A-62A-140A	558314 EAMC-42-50-12-24	558173 EAMK-A-S62-62A/B	567495 EAHM-L2-M6-90
558169 EAMM-A-S95-100A	558182 EAMF-A-95B-100A	558315 EAMC-56-58-19-25	558174 EAMK-A-S95-95A/B	-
558170 EAMM-A-S95-140A	558023 EAMF-A-95A-140A	558316 EAMC-56-58-24-25	558174 EAMK-A-S95-95A/B	567498 EAHM-L2-M8-100

Axiálne konštrukčné zostavy EAMM-A

údajový list

FESTO

Rozmery a údaje pre objednávku

stahovanie CAD modelov → www.festo.sk/engineering

ELGA-...

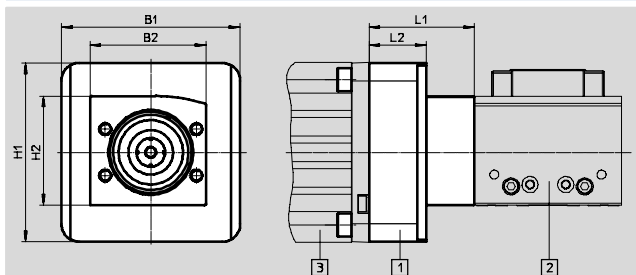

základná schéma:

- 1 axiálna konštrukčná zostava
- 2 os s ozubeným remeňom
- 3 motor

typ	B1	B2	H1	H2	L1	L2
EAMM-A-N38-70A	70	57,5	70	50,3	37,5	21
EAMM-A-N38-60G	60	57,5	60	50,3	49,5	33
EAMM-A-N48-100A	100	65	100	61	59	31,9
EAMM-A-N48-80G	100	65	100	61	59,1	32
EAMM-A-N80-80G	100	100	100	90,5	62,5	19
EAMM-A-N80-120G	124	100	124	90,5	77,5	34
EAMM-A-N80-140A	138	100	138	90,5	72,5	29

Jednotlivé diely

axiálna konštrukčná zostava

zloženie:

	príruba motora	spojka	teleso spojky	konštrukčná zostava skrutiek
č. dielu typ	č. dielu typ	č. dielu typ	č. dielu typ	č. dielu typ
1202331 EAMM-A-N38-70A	1202337 EAMF-A-38D-70A	558001 EAMD-32-32-11-16X20	1345947 EAMK-A-N38-38D	1202288 EAHM-L5-M6-35
1202253 EAMM-A-N38-60G	1190015 EAMF-A-38D-60G/H	558001 EAMD-32-32-11-16X20	1345947 EAMK-A-N38-38D	1202262 EAHM-L5-M6-40
1201894 EAMM-A-N48-100A	1201924 EAMF-A-48C-100A	558002 EAMD-42-40-19-16X25	1345949 EAMK-A-N48-48C	1201874 EAHM-L5-M6-50
1258793 EAMM-A-N48-80G	1190375 EAMF-A-48C-80G	1781043 EAMD-42-40-20-16X25-U	1345949 EAMK-A-N48-48C	1201874 EAHM-L5-M6-50
2372096 EAMM-A-N80-80G	2372201 EAMF-A-80A-80G	558004 EAMD-56-46-20-23X27	1345953 EAMK-A-N80-80A	1201712 EAHM-L5-M8-60
1201695 EAMM-A-N80-120G	1190702 EAMF-A-80A-120G	1188801 EAMD-56-46-25-23X27	1345953 EAMK-A-N80-80A	1201712 EAHM-L5-M8-60
1201691 EAMM-A-N80-140A	1190796 EAMF-A-80A-140A	558005 EAMD-56-46-24-23X27	1345953 EAMK-A-N80-80A	1201751 EAHM-L5-M8-75

Axiálne konštrukčné zostavy EAMM-A

údajový list

FESTO

Rozmery a údaje pre objednávku

EGC-HD-TB-...

stahovanie CAD modelov → www.festo.sk/engineering

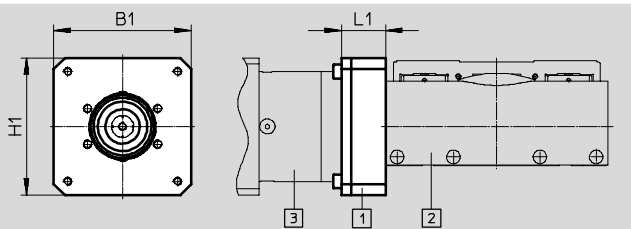

základná schéma:

- 1 axiálna konštrukčná zostava
- 2 os s ozubeným remeňom
- 3 motor

typ	B1	H1	L1
EAMM-A-M43-60G	60	60	33
EAMM-A-M48-80G	100	100	32
EAMM-A-M80-120G	124	124	34

Jednotlivé diely

axiálna konštrukčná zostava

zloženie:

príruba motora

spojka

strediaci krúžok

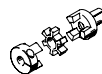
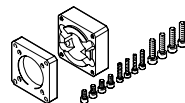
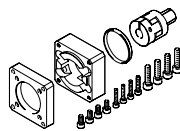

č. dielu

č. dielu

č. dielu

č. dielu

typ

typ

typ

typ

1190076

1597579

558001

575962

EAMM-A-M43-60G

EAMF-A-43D-60G/H

EAMD-32-32-11-16X20

EAML-43-4-43

1190421

1190375

1781043

558031

EAMM-A-M48-80G

EAMF-A-48C-80G

EAMD-42-40-20-16X25-U

EAML-48-4-48

1190774

1190702

1781045

1209006

EAMM-A-M80-120G

EAMF-A-80A-120G

EAMD-56-46-25-23X27-U

EAML-80-6-80

Axiálne konštrukčné zostavy EAMM-A

údajový list

FESTO

Rozmery a údaje pre objednávku

stahovanie CAD modelov → www.festo.sk/engineering

EGC-HD-BS-...

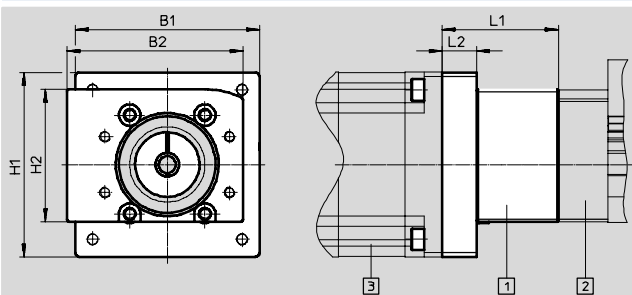

základná schéma:

- 1 axiálna konštrukčná zostava
- 2 os s vretenom
- 3 motor

typ	B1	B2	H1	H2	L1	L2
EAMM-A-S38-40A	58	69	44	50	44	7
EAMM-A-S38-40P	58	69	44	50	54	15,5
EAMM-A-S38-42A	58	69	44	50	52	15
EAMM-A-S38-55A	55	69	55	50	48	11
EAMM-A-S38-57A	56	69	56	50	48	11
EAMM-A-S38-60P	61,4	69	61,4	50	63,2	16
EAMM-A-S48-55A	70	82	55	61,5	47,2	9,2
EAMM-A-S48-57A	70	82	55	61,5	47,2	9,2
EAMM-A-S48-60P	61,4	82	61,4	61,5	74,7	17,5
EAMM-A-S48-70A	70	82	70	61,5	50,2	12,2
EAMM-A-S48-87A	85,8	82	85,8	61,5	54	16
EAMM-A-S62-70A	82	120	70	88,5	78,5	12
EAMM-A-S62-80P	81,3	120	81,3	88,5	64,7	17,5
EAMM-A-S62-87A	85,8	120	85,8	88,5	81,5	15
EAMM-A-S62-100A	100,5	120	100,5	88,5	81	14,5
EAMM-A-S62-140A	140	120	140	88,5	91	24,5

Jednotlivé diely

axiálna konštrukčná zostava





zloženie:

	príruba motora	spojka	teleso spojky	konštrukčná zostava skrutiek
č. dielu typ	č. dielu typ	č. dielu typ	č. dielu typ	č. dielu typ
558162 EAMM-A-S38-40A	558175 EAMF-A-38B-40A	558312 EAMC-30-32-6-6	558171 EAMK-A-S38-38A/B	-
2219044 EAMM-A-S38-40P	2219077 EAMF-A-38B-40P	533708 EAMC-30-32-6-8	558171 EAMK-A-S38-38A/B	-
558163 EAMM-A-S38-55A	558176 EAMF-A-38A-55A	551003 EAMC-30-32-6-9	558171 EAMK-A-S38-38A/B	567488 EAHM-L2-M5-50
560685 EAMM-A-S38-42A	560691 EAMF-A-38B-42A	561333 EAMC-30-32-5-6	558171 EAMK-A-S38-38A/B	-
560686 EAMM-A-S38-57A	560692 EAMF-A-38A-57A	551002 EAMC-30-32-6-6,35	558171 EAMK-A-S38-38A/B	567488 EAHM-L2-M5-50
558164 EAMM-A-S48-55A	558177 EAMF-A-48B-55A	543423 EAMC-30-32-8-9	558172 EAMK-A-S48-48A/B	-
2219110 EAMM-A-S38-60P	1987412 EAMM-A-38A-60P	1233256 EAMC-30-32-6-14	558171 EAMK-A-S38-38A/B	567489 EAHM-L2-M5-55
560687 EAMM-A-S48-57A	560694 EAMF-A-48B-57A	543421 EAMC-30-32-6,35-8	558172 EAMK-A-S48-48A/B	-
2220560 EAMM-A-S48-60P	2220620 EAMF-A-48A-60P	562682 EAMC-30-32-8-14	558172 EAMK-A-S48-48A/B	567489 EAHM-L2-M5-55
558165 EAMM-A-S48-70A	558025 EAMF-A-48A-70A	551004 EAMC-30-32-8-11	558172 EAMK-A-S48-48A/B	567488 EAHM-L2-M5-50
560688 EAMM-A-S48-87A	560695 EAMF-A-48A-87A	551004 EAMC-30-32-8-11	558172 EAMK-A-S48-48A/B	567489 EAHM-L2-M5-55

Axiálne konštrukčné zostavy EAMM-A

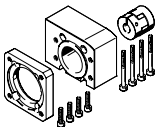
údajový list

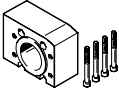
FESTO

Jednotlivé diely				
axiálna konštrukčná zostava	zloženie:			
	príruba motora	spojka	teleso spojky	konštrukčná zostava skrutiek
				
č. dielu typ	č. dielu typ	č. dielu typ	č. dielu typ	č. dielu typ
558166 EAMM-A-S62-70A	558179 EAMF-A-62B-70A	558313 EAMC-42-66-11-12	558173 EAMK-A-S62-62A/B	-
2222582 EAMM-A-S62-80P	2222624 EAMF-A-62B-80P	551005 EAMC-42-50-12-19	558173 EAMK-A-S62-62A/B	-
560689 EAMM-A-S62-87A	560696 EAMF-A-62B-87A	558313 EAMC-42-66-11-12	558173 EAMK-A-S62-62A/B	-
558167 EAMM-A-S62-100A	558026 EAMF-A-62A-100A	551005 EAMC-42-50-12-19	558173 EAMK-A-S62-62A/B	567494 EAHM-L2-M6-80
558168 EAMM-A-S62-140A	558022 EAMF-A-62A-140A	558314 EAMC-42-50-12-24	558173 EAMK-A-S62-62A/B	567495 EAHM-L2-M6-90

Axiálne konštrukčné zostavy EAMM-A

údajový list

FESTO

Rozmery a údaje pre objednávku

stahovanie CAD modelov → www.festo.sk/engineering

EGSK-..., EGSP-...

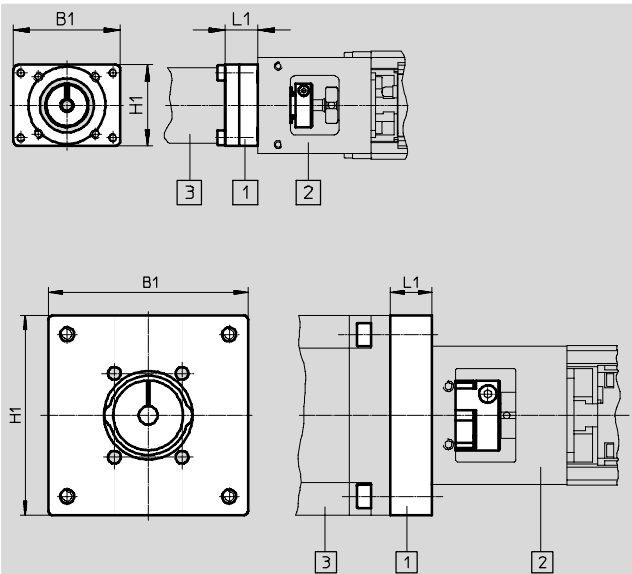

základná schéma:

- 1 axiálna konštrukčná zostava
- 2 elektrické presné vedenie s vretenom
- 3 motor

typ	B1	H1	L1
EAMM-A-P3-28D-28A	30	30	15
EAMM-A-P3-28D-40P	39,7	39,7	14,5
EAMM-A-P4-28B-28A	39,6	30	12
EAMM-A-P4-28B-40A	40	40	8,3
EAMM-A-P4-28B-40P	39,7	39,7	12,5
EAMM-A-P4-28B-42A	42	42	16,5
EAMM-A-P5-28B-28A	39,6	30	12
EAMM-A-P5-28B-40A	40	40	8,3
EAMM-A-P5-28B-40P	39,7	39,7	12,5
EAMM-A-P5-28B-42A	42	42	16,5
EAMM-A-P6-38A-40A	50	50	9
EAMM-A-P6-38A-40P	50	50	10,7
EAMM-A-P6-38A-42A	55	55	15
EAMM-A-P6-38A-55A	55	55	11
EAMM-A-P6-38A-57A	56	56	11
EAMM-A-P6-38A-60P	61,4	61,4	21
EAMM-A-P8-38A-40A	50	50	9
EAMM-A-P8-38A-40P	50	50	10,7
EAMM-A-P8-38A-42A	55	55	15
EAMM-A-P8-38A-55A	55	55	11
EAMM-A-P8-38A-57A	56	56	11
EAMM-A-P8-38A-60P	61,4	61,4	21
EAMM-A-P8-38A-70A	70	70	13,8
EAMM-A-P8-38A-87A	85,8	85,8	18
EAMM-A-P10-38A-55A	55	55	11
EAMM-A-P10-38A-57A	56	56	11
EAMM-A-P10-38A-60A	61,4	61,4	21
EAMM-A-P10-38A-70A	70	70	13,8
EAMM-A-P10-38A-87A	85,8	85,8	18

Jednotlivé diely

axiálna konštrukčná zostava

zloženie:

príruba motora

spojka

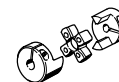
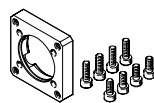
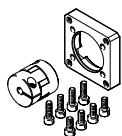

č. dielu

č. dielu

č. dielu

typ

typ

typ

1703478

EAMM-A-P3-28D-28A

1087613

EAMF-A-28D-28A

562672

EAMC-16-20-3-5

1982886

EAMM-A-P3-28D-40P

1982014

EAMF-A-28D-40P

2310368

EAMC-16-20-3-8

1731466

EAMM-A-P4-28B-28A

1704476

EAMF-A-28B-28A

562674

EAMC-16-20-4-5

1983071

EAMM-A-P4-28B-40P

1976704

EAMF-A-28B-40P

562675

EAMC-16-20-4-8

562637

EAMM-A-P4-28B-40A

552163

EAMF-A-28B-40A

562673

EAMC-16-20-4-6

562636

EAMM-A-P4-28B-42A

552164

EAMF-A-28B-42A

562674

EAMC-16-20-4-5

Axiálne konštrukčné zostavy EAMM-A

údajový list

FESTO

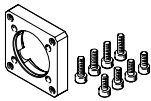
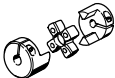
Jednotlivé diely		
axiálna konštrukčná zostava	zloženie:	
	príruba motora	spojka
		
č. dielu typ	č. dielu typ	č. dielu typ
1731474 EAMM-A-P5-28B-28A	1704476 EAMF-A-28B-28A	562676 EAMC-16-20-5-5
562641 EAMM-A-P5-28B-40A	552163 EAMF-A-28B-40A	543419 EAMC-16-20-5-6
1983122 EAMM-A-P5-28B-40P	1976704 EAMF-A-28B-40P	562677 EAMC-16-20-5-8
562640 EAMM-A-P5-28B-42A	552164 EAMF-A-28B-42A	562676 EAMC-16-20-5-5
562646 EAMM-A-P6-38A-40A	562667 EAMF-A-38A-40A	558312 EAMC-30-32-6-6
1983450 EAMM-A-P6-38A-40P	1984478 EAMF-A-38A-40P	533708 EAMC-30-32-6-8
562644 EAMM-A-P6-38A-42A	562668 EAMF-A-38A-42A	561333 EAMC-30-32-5-6
562647 EAMM-A-P6-38A-55A	558176 EAMF-A-38A-55A	551003 EAMC-30-32-6-9
562645 EAMM-A-P6-38A-57A	560692 EAMF-A-38A-57A	551002 EAMC-30-32-6-6,35
2264375 EAMM-A-P6-38A-60P	1987412 EAMF-A-38A-60P	1233256 EAMC-30-32-6-14
562652 EAMM-A-P8-38A-40A	562667 EAMF-A-38A-40A	533708 EAMC-30-32-6-8
1986292 EAMM-A-P8-38A-40P	1984478 EAMF-A-38A-40P	543422 EAMC-30-32-8-8
562650 EAMM-A-P8-38A-42A	562668 EAMF-A-38A-42A	562678 EAMC-30-32-5-8
562653 EAMM-A-P8-38A-55A	558176 EAMF-A-38A-55A	543423 EAMC-30-32-8-9
562651 EAMM-A-P8-38A-57A	560692 EAMF-A-38A-57A	543421 EAMC-30-32-6.35-8
1987308 EAMM-A-P8-38A-60P	1987412 EAMF-A-38A-60P	562682 EAMC-30-32-8-14
564996 EAMM-A-P8-38A-70A	558018 EAMF-A-38A-70A	551004 EAMC-30-32-8-11
564998 EAMM-A-P8-38A-87A	560693 EAMF-A-38A-87A	551004 EAMC-30-32-8-11
562659 EAMM-A-P10-38A-55A	558176 EAMF-A-38A-55A	562680 EAMC-30-32-9-10
562658 EAMM-A-P10-38A-57A	560692 EAMF-A-38A-57A	562679 EAMC-30-32-6.35-10
2036017 EAMM-A-P10-38A-60P	1987412 EAMF-A-38A-60P	562683 EAMC-30-32-10-14
564997 EAMM-A-P10-38A-70A	558018 EAMF-A-38A-70A	565008 EAMC-30-32-10-11
564999 EAMM-A-P10-38A-87A	560693 EAMF-A-38A-87A	565008 EAMC-30-32-10-11

Axiálne konštrukčné zostavy EAMM-A

údajový list

FESTO

Rozmery a údaje pre objednávku

stahovanie CAD modelov → www.festo.sk/engineering

ELGG-..., ELGR-...

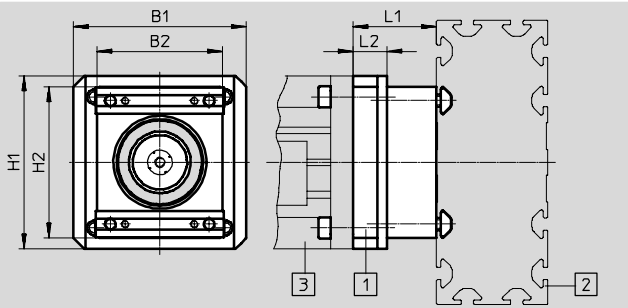

základná schéma:

- 1 axiálna konštrukčná zostava
- 2 os s ozubeným remeňom
- 3 motor

typ	B1	B2	H1	H2	L1	L2
EAMM-A-R27-55A	55	44,5	55	48,3	26	11
EAMM-A-R27-57A	56	44,5	56	48,3	26	11
EAMM-A-R38-57A	56	–	–	–	31	–
EAMM-A-R38-60P	61,4	51	61,4	61	41	21
EAMM-A-R38-70A	70	51	70	61	33,8	13,8
EAMM-A-R38-87A	85,8	51	85,8	61	38	18
EAMM-A-R48-70A	70	–	–	–	40,2	–
EAMM-A-R48-80P	81,3	55	81,3	81	54	26
EAMM-A-R48-87A	85,5	55	85,5	81	44	16
EAMM-A-R48-100A	100,5	55	100,5	81	59	31

Jednotlivé diely

axiálna konštrukčná zostava	zloženie:		
	príruba motora	spojka	teleso spojky
č. dielu typ	č. dielu typ	č. dielu typ	č. dielu typ
1133400 EAMM-A-R27-55A	558176 EAMF-A-38A-55A	557999 EAMD-19-15-9-8X10	1133397 EAMK-A-R27-38A
1133403 EAMM-A-R27-57A	560692 EAMF-A-38A-57A	561292 EAMD-16-15-6.35-8X10	1133397 EAMK-A-R27-38A
1578138 EAMM-A-R38-57A	560692 EAMF-A-38A-57A	561293 EAMD-25-22-6.35-10X12	1133398 EAMK-A-R38-38A
2224996 EAMM-A-R38-60P	1987412 EAMF-A-38A-60P	1453861 EAMD-28-22-14-10X12	1133398 EAMK-A-R38-38A
1133401 EAMM-A-R38-70A	558018 EAMF-A-38A-70A	558000 EAMD-25-22-11-10X12	1133398 EAMK-A-R38-38A
1133404 EAMM-A-R38-87A	560693 EAMF-A-38A-87A	558000 EAMD-25-22-11-10X12	1133398 EAMK-A-R38-38A
1578139 EAMM-A-R48-70A	558025 EAMF-A-48A-70A	558001 EAMD-32-32-11-16X20	1133399 EAMK-A-R48-48A
2225090 EAMM-A-R48-80P	2043427 EAMF-A-48A-80P	558002 EAMD-42-40-19-16X25	1133399 EAMK-A-R48-48A
1133405 EAMM-A-R48-87A	560695 EAMF-A-48A-87A	558001 EAMD-32-32-11-16X20	1133399 EAMK-A-R48-48A
1133402 EAMM-A-R48-100A	558020 EAMF-A-48A-100A	558002 EAMD-42-40-19-16X25	1133399 EAMK-A-R48-48A

Axiálne konštrukčné zostavy EAMM-A

údajový list

FESTO

Rozmery a údaje pre objednávku

stahovanie CAD modelov → www.festo.sk/engineering

DGEA-...

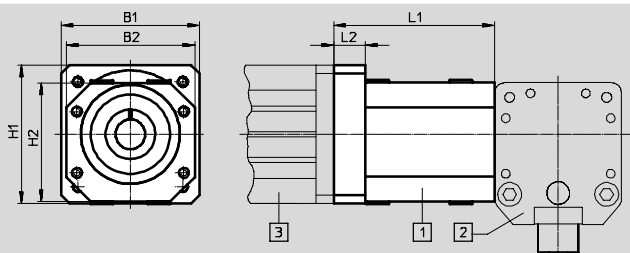

základná schéma:



- 1 axiálna konštrukčná zostava
- 2 výložníková os
- 3 motor

typ	B1	B2	H1	H2	L1	L2
EAMM-A-F28-57A	56,4	45	56,4	45	52,7	12
EAMM-A-F28-60G	60	45	60	45	60,7	20
EAMM-A-F28-87A	85,8	45	85,8	45	56,2	15,5
EAMM-A-F32-60G	70	65	70	60	89,4	24
EAMM-A-F32-87A	85,8	65	85,8	60	82,7	17,5
EAMM-A-F40-80G	90	65	90	60	89,4	24

Jednotlivé diely

axiálna konštrukčná zostava

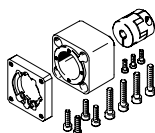
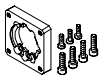
zloženie:

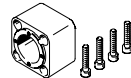
 č. dielu typ	 príruha motora			 spojka		 teleso spojky	
	č. dielu typ	č. dielu typ	č. dielu typ	č. dielu typ	č. dielu typ		
550956 EAMM-A-F28-57A	530081 EAMF-A-44A/B-57A	530088 EAMC-30-35-6.35-8	530468 EAMK-A-F28-44A				
550957 EAMM-A-F28-60G	529944 EAMF-A-44A/B-60G	123042 EAMC-30-35-8-11	530468 EAMK-A-F28-44A				
550958 EAMM-A-F28-87A	530082 EAMF-A-44A/B-87A	123042 EAMC-30-35-8-11	530468 EAMK-A-F28-44A				
550959 EAMM-A-F32-60G	550987 EAMF-A-64A/B-60G/H	530090 EAMC-40-66-11-11	530469 EAMK-A-F32-64A				
550960 EAMM-A-F32-87A	533140 EAMF-A-64A/B-87A	530090 EAMC-40-66-11-11	530469 EAMK-A-F32-64A				
550935 EAMM-A-F40-80G	533139 EAMF-A-64A/C-80G	123845 EAMC-40-66-15-20	124629 EAMK-A-F40-64A				

Axiálne konštrukčné zostavy EAMM-A

príslušenstvo

FESTO

Sada tesnení

obsahuje LABS látky

v zmysle RoHS



Typové označenie						
typ	pre axiálnu konštrukčnú zostavu	pre elektrické valce	teplota okolia [°C]	KBK ¹⁾	č. dielu	typ
EADS-F-D32-40A	EAMM-A-D32-40A	DNCE	-25 ... +60	4	1561526	EADS-F-D32-40A
EADS-F-D32-40P	EAMM-A-D32-40P	DNCE			2207219	EADS-F-D32-40P
EADS-F-D32-60P	EAMM-A-D32-60P	DNCE			2234012	EADS-F-D32-60P
EADS-F-D32-42A	EAMM-A-D32-42A	DNCE			1561527	EADS-F-D32-42A
EADS-F-D32-55A	EAMM-A-D32-55A	DNCE			1561528	EADS-F-D32-55A
EADS-F-D32-57A	EAMM-A-D32-57A	DNCE			1561529	EADS-F-D32-57A
EADS-F-D40-55A	EAMM-A-D40-55A	DNCE			1561530	EADS-F-D40-55A
EADS-F-D40-57A	EAMM-A-D40-57A	DNCE			1561531	EADS-F-D40-57A
EADS-F-D40-60P	EAMM-A-D40-60P	DNCE			2151545	EADS-F-D40-60P
EADS-F-D40-70A	EAMM-A-D40-70A	DNCE			1561532	EADS-F-D40-70A
EADS-F-D40-87A	EAMM-A-D40-87A	DNCE			1561533	EADS-F-D40-87A
EADS-F-D60-70A	EAMM-A-D60-70A	DNCE			1561534	EADS-F-D60-70A
EADS-F-D60-80P	EAMM-A-D60-80P	DNCE, ESBF			2218523	EADS-F-D60-80P
EADS-F-D60-87A	EAMM-A-D60-87A	DNCE			1561536	EADS-F-D60-87A
EADS-F-D60-100A	EAMM-A-D60-100A	DNCE, ESBF			1561537	EADS-F-D60-100A
EADS-F-D60-70A	EAMM-A-D60-70A	ESBF			1679570	EADS-F-D60-70A
EADS-F-D60-100A	EAMM-A-D60-100A	DNCE, ESBF			1679522	EADS-F-D60-100A
EADS-F-D80-100A	EAMM-A-D80-100A	ESBF			1593617	EADS-F-D80-100A
EADS-F-D80-140A	EAMM-A-D80-140A	ESBF			1593671	EADS-F-D80-140A
EADS-F-D100-140A	EAMM-A-D100-140A	ESBF			1593991	EADS-F-D100-140A

1) Trieda odolnosti proti korózii KBK 4 podľa normy Festo FN 940070

Volné pôsobenie poveternostných vplyvov v ťažkých korozívnych podmienkach. Diely v prostredí s agresívnymi látkami, napr. v potravinárstve alebo v chemickom priemysle. Tieto aplikácie musia byť v prípade potreby overené špeciálnymi skúškami (→ tiež FN 940082) s príslušnými médiami.