

Angle seat valves VZXF

FESTO



Angle seat valves VZXF

Key features and overview



FESTO

Function

The angle seat valve VZXF is an externally controlled 2/2-way valve. Valves of this design are switched by means of an additional pilot medium. The valve is closed by spring force when at rest. It is opened when pilot pressure is

applied to the drive. The supply of the pilot medium into the drive chamber is controlled by an external valve that must be additionally integrated into the supply cable for the pilot medium.

General information

-  - Connecting thread
G $\frac{1}{2}$... G2
-  - Flow rate Kv
2.8 ... 47.5 m³/h

Design

- Gunmetal (red brass) design
- Stainless steel design

Advantages

- Insensitive to steam or slightly contaminated media
- No pressure differential required between the inlet and outlet
- Low flow resistance
- Long service life
- Low maintenance

Application

- Angle seat valves control suitable gaseous and liquid media in rigid tubing systems without the need for any pressure differential

Variants

Gunmetal (red brass) design

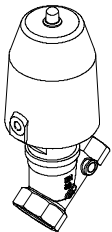

Stainless steel design

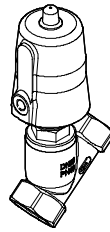

Angle seat valves VZXF

Key features and overview

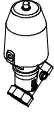
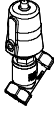
Design	Type	Process valve connection	Nominal size (DN)	Process valve nominal pressure (PN)	→ Page/Internet
Gunmetal (red brass)					
	VZXF-L-...-H3B1-...	G1/2	15	16	6
		G3/4	20		
		G1	25		
		G1 1/4	32		
		G1 1/2	40		
		G2	50		
Stainless steel					
	VZXF-L-...-V4V4T-...	G1/2	15	40	9
		G3/4	20		
		G1	25		
		G1 1/4	32		
		G1 1/2	40		
		G2	50		

Angle seat valves VZXF

Type codes

FESTO

		VZXF	L	M22C	M	A	G12	130	M1
Type		VZXF							
VZXF	Angle seat valve, externally controlled								
Type of directional control valve			L						
L	In-line valve								
Valve function				M22C					
M22C	2/2-way valve, normally closed								
Reset method for single solenoid valves					M				
M	Mechanical spring								
Media flow						A			
A	Over valve seat, closes with the flow of media								
B	Under valve seat, closes against the flow of media								
Process valve connection							G12		
G12	Thread G1½								
G34	Thread G¾								
G1	Thread G1								
G114	Thread G1¼								
G112	Thread G1½								
G2	Thread G2								
Nominal size								130	
120	12 mm								
130	13 mm								
160	16 mm								
180	18 mm								
230	23 mm								
240	24 mm								
290	29 mm								
310	31 mm								
350	35 mm								
430	43 mm								
450	45 mm								
Temperature range of medium									M1
	Standard, -10 ... +80 °C								
M1	-40 ... +200 °C								

Angle seat valves VZXF

Type codes

		H3	B1		-	50	-	10
Housing material								
H3	Gunmetal (red brass)							
V4	Stainless steel							
Housing, drive material								
B1	Brass							
V4	Stainless steel							
Sealing material								
	Standard, NBR							
T	PTFE							
Drive size								
50	50 mm							
80	80 mm							
Medium pressure								
3	Max. 3 bar							
4	Max. 4 bar							
5	Max. 5 bar							
6	Max. 6 bar							
7	Max. 7 bar							
8	Max. 8 bar							
9	Max. 9 bar							
10	Max. 10 bar							
12	Max. 12 bar							
16	Max. 16 bar							
20	Max. 20 bar							
22	Max. 22 bar							
25	Max. 25 bar							
40	Max. 40 bar							

Angle seat valves VZXF

Technical data – Gunmetal (red brass) design

FESTO

Function

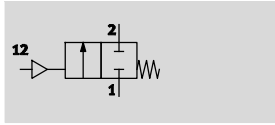

Flow rate Kv
2.8 ... 33.8 m³/h

Connecting thread
G¹/₂ ... G2



General technical data			
Process valve connection	G ¹ / ₂	G ³ / ₄	G1
Auxiliary pilot air connection	G ¹ / ₈		
Nominal size (DN)	15	20	25
Valve function	2/2-way, single solenoid, closed		
Design	Poppet valve with spring return		
Type of mounting	In-line installation		
Mounting position	Any		
Direction of flow	Non-reversible		
Exhaust function	No flow control		
Sealing principle	Soft		
Reset method	Mechanical spring		
Actuation type	Pneumatic		
Type of control	External		
Pilot medium	Filtered compressed air, grade of filtration 40 µm, lubricated or unlubricated		
Switching time on [ms]	100		
Switching time off [ms]	310		
Product weight [g]	1,200	1,300	1,500

Process valve connection	G1 ¹ / ₄	G1 ¹ / ₂	G2
Auxiliary pilot air connection	G ¹ / ₈		
Nominal size (DN)	32	40	50
Valve function	2/2-way, single solenoid, closed		
Design	Poppet valve with spring return		
Type of mounting	In-line installation		
Mounting position	Any		
Direction of flow	Non-reversible		
Exhaust function	No flow control		
Sealing principle	Soft		
Reset method	Mechanical spring		
Actuation type	Pneumatic		
Type of control	External		
Pilot medium	Filtered compressed air, grade of filtration 40 µm, lubricated or unlubricated		
Switching time on [ms]	110		120
Switching time off [ms]	320		320
Product weight [g]	1,800	2,400	3,500

Angle seat valves VZXF

Technical data – Gunmetal (red brass) design

FESTO

Operating and environmental conditions			
Process valve connection		G1/2	G3/4
Process valve nominal pressure (PN)		16	
Pilot pressure	[bar]	4 ... 10	
Standard nominal flow rate	[l/min]	3,000	12,000
Flow rate	[m ³ /h]	2.8	11.2
Medium		Filtered compressed air, grade of filtration 200 µm	
		Mineral oil-based hydraulic oil	
		Inert gases	
		Mineral oil	
		Neutral fluids	
		Water	
Max. viscosity	[mm ² /s]	600	
Ambient temperature	[°C]	-10 ... +60	
Temperature of medium	[°C]	-10 ... +80	
CE marking (see declaration of conformity)		-	
Corrosion resistance class CRC ¹⁾		1	

- 1) Corrosion resistance class 1 according to Festo standard 940 070
Components subject to low corrosion stress. Transport and storage protection. Parts that do not have primarily decorative surface requirements, e.g. in internal areas that are not visible or behind covers.

Operating and environmental conditions			
Process valve connection		G1¼	G1½
Process valve nominal pressure (PN)		16	
Pilot pressure	[bar]	4 ... 10	
Standard nominal flow rate	[l/min]	18,600	36,100
Flow rate	[m ³ /h]	17.5	33.8
Medium		Filtered compressed air, grade of filtration 200 µm	
		Mineral oil-based hydraulic oil	
		Inert gases	
		Mineral oil	
		Neutral fluids	
		Water	
Max. viscosity	[mm ² /s]	600	
Ambient temperature	[°C]	-10 ... +60	
Temperature of medium	[°C]	-10 ... +80	
CE marking (see declaration of conformity)		To EU Pressure Equipment Directive	
Corrosion resistance class CRC ¹⁾		1	

- 1) Corrosion resistance class 1 according to Festo standard 940 070
Components subject to low corrosion stress. Transport and storage protection. Parts that do not have primarily decorative surface requirements, e.g. in internal areas that are not visible or behind covers.

Materials		
Angle seat valve		Material number
① Housing	Gunmetal (red brass)	CC499K
② Drive head	Brass	-
③ Seals	Nitrile rubber	-
- Note on materials	Contains PWIS (paint-wetting impairment substances), RoHS-compliant	-

Angle seat valves VZXF

Technical data – Gunmetal (red brass) design

Dimensions

Download CAD data → www.festo.com

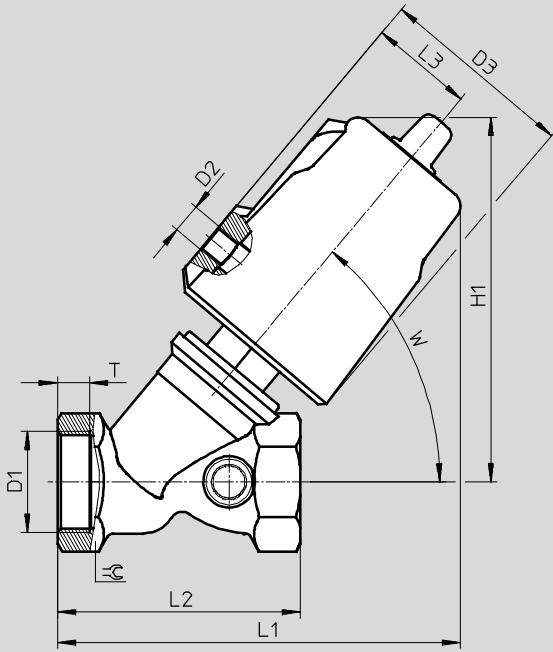

	D1	D2	D3 Ø	H1	L1	L2	L3	T	W	∠
VZXF-L-...-G12-...-H3B1-50-...	G½	G⅛	62	112	123	66	34	8	50°	27
VZXF-L-...-G34-...-H3B1-50-...	G¾			117	130	75		9		33
VZXF-L-...-G1-...-H3B1-50-...	G1			121	133	80		10.5		41
VZXF-L-...-G1¼-...-H3B1-50-...	G1¼			139	154	97		12.5		50
VZXF-L-...-G1½-...-H3B1-50-...	G1½			145	161	107		14.5		56
VZXF-L-...-G2-...-H3B1-50-...	G2			154	171	124		16.5		68

Ordering data Angle seat valve VZXF

	Process valve connection	Part No.	Type
	G½	1002500	VZXF-L-M22C-M-A-G12-120-H3B1-50-16
		1002501	VZXF-L-M22C-M-B-G12-120-H3B1-50-16
	G¾	1002502	VZXF-L-M22C-M-A-G34-160-H3B1-50-16
		1002503	VZXF-L-M22C-M-B-G34-160-H3B1-50-16
	G1	1002504	VZXF-L-M22C-M-A-G1-230-H3B1-50-16
		1002505	VZXF-L-M22C-M-B-G1-230-H3B1-50-10
	G1¼	1002506	VZXF-L-M22C-M-A-G1¼-290-H3B1-50-10
		1002507	VZXF-L-M22C-M-B-G1¼-290-H3B1-50-7
	G1½	1002508	VZXF-L-M22C-M-A-G1½-350-H3B1-50-8
		1002509	VZXF-L-M22C-M-B-G1½-350-H3B1-50-6
	G2	1002510	VZXF-L-M22C-M-A-G2-430-H3B1-50-4
		1002511	VZXF-L-M22C-M-B-G2-430-H3B1-50-3

Angle seat valves VZXF

Technical data – Stainless steel design

FESTO

Function

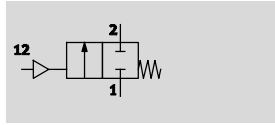

-  - Flow rate Kv
2.8 ... 47.5 m³/h

-  - Connecting thread
G $\frac{1}{2}$... G2



General technical data					
Process valve connection	G $\frac{1}{2}$	G $\frac{3}{4}$	G1	G1 $\frac{1}{4}$	
Auxiliary pilot air connection	G $\frac{1}{8}$				
Nominal size (DN)	15	20	25	25	32
Valve function	2/2-way, single solenoid, closed				
Design	Poppet valve with spring return				
Type of mounting	In-line installation				
Mounting position	Any				
Direction of flow	Non-reversible				
Exhaust function	No flow control				
Sealing principle	Soft				
Reset method	Mechanical spring				
Actuation type	Pneumatic				
Type of control	External				
Pilot medium	Filtered compressed air, grade of filtration 40 μ m, lubricated or unlubricated				
Switching time on [ms]	100			150	110
Switching time off [ms]	310			390	320
Product weight [g]	1,300	1,400	1,600	3,600	2,200

Process valve connection	G1 $\frac{1}{4}$	G1 $\frac{1}{2}$	G2		
Auxiliary pilot air connection	G $\frac{1}{8}$				
Nominal size (DN)	32	40	40	50	50
Valve function	2/2-way, single solenoid, closed				
Design	Poppet valve with spring return				
Type of mounting	In-line installation				
Mounting position	Any				
Direction of flow	Non-reversible				
Exhaust function	No flow control				
Sealing principle	Soft				
Reset method	Mechanical spring				
Actuation type	Pneumatic				
Type of control	External				
Pilot medium	Filtered compressed air, grade of filtration 40 μ m, lubricated or unlubricated				
Switching time on [ms]	150	110	150	120	150
Switching time off [ms]	390	320	390	320	390
Product weight [g]	4,200	2,500	4,400	3,500	5,500

Angle seat valves VZXF

Technical data – Stainless steel design

FESTO

Operating and environmental conditions					
Process valve connection	G1/2	G3/4	G1	G1 1/4	
Process valve nominal pressure (PN)	40				
Pilot pressure [bar]	4 ... 10				
Standard nominal flow rate [l/min]	3,000	6,800	12,000	15,200	18,600
Flow rate [m ³ /h]	2.8	6.4	11.2	14.3	17.4
Medium	Filtered compressed air, grade of filtration 200 µm				
	Mineral oil-based hydraulic oil				
	Inert gases				
	Mineral oil				
	Neutral fluids				
	Water				
Max. viscosity [mm ² /s]	600				
Ambient temperature [°C]	-10 ... +60				
Temperature of medium [°C]	-40 ... +200				
CE marking (see declaration of conformity)	-				To EU Pressure Equipment Directive
Corrosion resistance class CRC ¹⁾	3				

- 1) Corrosion resistance class 3 according to Festo standard 940 070
Components subject to high corrosion stress. Externally visible parts with primarily decorative surface requirements which are in direct contact with a normal industrial environment or media such as solvents and cleaning agents.

Process valve connection	G1 1/4	G1 1/2		G2	
Process valve nominal pressure (PN)	40				
Pilot pressure [bar]	4 ... 10				
Standard nominal flow rate [l/min]	23,000	23,500	28,200	36,100	50,700
Flow rate [m ³ /h]	21.5	22	26.4	33.8	47.5
Medium	Filtered compressed air, grade of filtration 200 µm				
	Mineral oil-based hydraulic oil				
	Inert gases				
	Mineral oil				
	Neutral fluids				
	Water				
Max. viscosity [mm ² /s]	600				
Ambient temperature [°C]	-10 ... 60				
Temperature of medium [°C]	-40 ... 200				
CE marking (see declaration of conformity)	To EU Pressure Equipment Directive				
Corrosion resistance class CRC ¹⁾	3				

- 1) Corrosion resistance class 3 according to Festo standard 940 070
Components subject to high corrosion stress. Externally visible parts with primarily decorative surface requirements which are in direct contact with a normal industrial environment or media such as solvents and cleaning agents.

Materials		
Angle seat valve		Material number
1) Housing	Stainless steel casting	1.4408
2) Drive head	Stainless steel	-
3) Seals	PTFE	-
- Note on materials	Contains PWIS (paint-wetting impairment substances), RoHS-compliant	-

Angle seat valves VZXF

Technical data – Stainless steel design

Dimensions

Download CAD data → www.festo.com

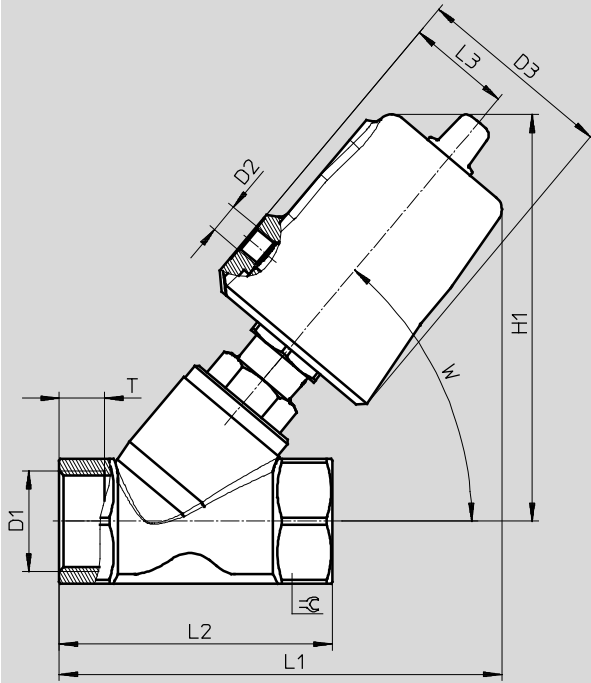

	D1	D2	D3 Ø	H1	L1	L2	L3	T	W	≈∠
VZXF-L-...-G12-...-V4V4T-50-...	G1/2	G1/8	62	129	135	65	34	12	50°	27
VZXF-L-...-G34-...-V4V4T-50-...	G3/4			130	138	75		13		32
VZXF-L-...-G1-...-V4V4T-50-...	G1			135	146	90	15	42		
VZXF-L-...-G1-...-V4V4T-80-...	G1		94	177	184	48	17	50		
VZXF-L-...-G114-...-V4V4T-50-...	G1 1/4		62	151	155	110				34
VZXF-L-...-G114-...-V4V4T-80-...	G1 1/4		94	183	194	48	19	55		
VZXF-L-...-G112-...-V4V4T-50-...	G1 1/2		62	155	174	120	34			
VZXF-L-...-G112-...-V4V4T-80-...	G1 1/2		94	187	202	48	21	70		
VZXF-L-...-G2-...-V4V4T-50-...	G2		62	167	193	150				34
VZXF-L-...-G2-...-V4V4T-80-...	G2		94	199	222	48				

Angle seat valves VZXF

Technical data – Stainless steel design

FESTO

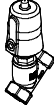
Ordering data Angle seat valve VZXF		Part No.	Type
	G $\frac{1}{2}$	1002512	VZXF-L-M22C-M-A-G12-130-M1-V4V4T-50-25
		1002513	VZXF-L-M22C-M-B-G12-130-M1-V4V4T-50-40
	G $\frac{3}{4}$	1002514	VZXF-L-M22C-M-A-G34-180-M1-V4V4T-50-20
		1002515	VZXF-L-M22C-M-B-G34-180-M1-V4V4T-50-20
	G1	1002516	VZXF-L-M22C-M-A-G1-240-M1-V4V4T-50-16
		1002517	VZXF-L-M22C-M-B-G1-240-M1-V4V4T-50-10
		1002525	VZXF-L-M22C-M-A-G1-240-M1-V4V4T-80-40
		1002526	VZXF-L-M22C-M-B-G1-240-M1-V4V4T-80-22
	G1 $\frac{1}{4}$	1002518	VZXF-L-M22C-M-A-G114-310-M1-V4V4T-50-9
		1002519	VZXF-L-M22C-M-B-G114-310-M1-V4V4T-50-7
		1002527	VZXF-L-M22C-M-A-G114-310-M1-V4V4T-80-25
		1002528	VZXF-L-M22C-M-B-G114-310-M1-V4V4T-80-10
	G1 $\frac{1}{2}$	1002520	VZXF-L-M22C-M-A-G112-350-M1-V4V4T-50-7
		1002521	VZXF-L-M22C-M-B-G112-350-M1-V4V4T-50-6
		1002529	VZXF-L-M22C-M-A-G112-350-M1-V4V4T-80-20
		1002530	VZXF-L-M22C-M-B-G112-350-M1-V4V4T-80-8
	G2	1002522	VZXF-L-M22C-M-A-G2-450-M1-V4V4T-50-4
		1002523	VZXF-L-M22C-M-B-G2-450-M1-V4V4T-50-3
		1002531	VZXF-L-M22C-M-A-G2-450-M1-V4V4T-80-12
		1002532	VZXF-L-M22C-M-B-G2-450-M1-V4V4T-80-5