

Solenoid valves VSNC



Solenoid valves VSNC

Key features and product range overview – VSNC-...

Function

VSNC valves are pilot valves for single- and double-acting quarter turn and linear actuators with a port pattern in accordance with VDI/VDE 3845, such as DRD/DRE, DAPS, DFPB. DLP. Mounting on actuators without a NAMUR interface, e.g. diaphragm actuators, is also possible thanks to appropriate accessories such as a connection plate kit. They are designed for the requirements of process automation. Mechanical springs (single-solenoid valves) ensure secure switching to the initial position in the event of a power failure.

Innovative

- Conversion from 3/2-way to 5/2-way valve simply by turning the seal
- Enables single- or double-acting actuators to be controlled with one valve
- The valve can be ordered either with non-detenting/detenting or non-detenting manual override or without manual override. It is converted using a special cover. The part number is therefore identical. The manual override option can be changed at any time

Cost- and application-optimised

- Cost-optimised variant with plastic cover and brass armature tube and IP65 coils

 Voltage
12, 24 V DC
24, 48, 120, 230 V AC

 Operating pressure
2.5 ... 10 bar

 Temperature range
-20 ... 60 °C

Versatile

- Application-optimised variant with aluminium cover, stainless steel armature tube for IP65 and Ex coils, and protective cap for armature tube exhaust
- One armature tube system for all Ex solenoid systems
- For zone 1 to IEC Ex with type of ignition protection
 - Ex-ia
 - Ex-mb
- For zone 2 to IEC Ex with type of ignition protection
 - Ex-nA
- For Class I, Div I to NEC 505
- AEx-m



VSNC-F8



VSNC with IP65 solenoid

VSNC-FN

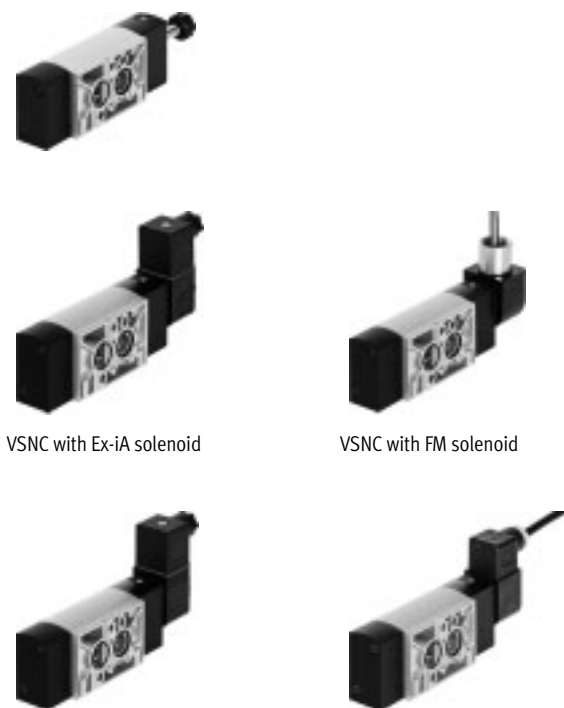

VSNC with Ex-ia solenoid

VSNC with FM solenoid

VSNC with Ex-nA solenoid

VSNC with Ex-m solenoid

Solenoid valves VSNC

Key features and product range overview – VSNC-...-F8

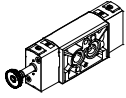
VSNC-F8

- Valve cover cap material: Plastic/metal
- Armature material: Brass
- Pilot air (incoming air of armature tube), unprotected

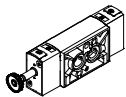
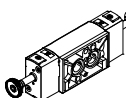
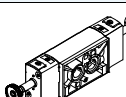
Version	Type	Pneumatic connection 1, 3, 5	Pneumatic connection 2, 4, based on standard	Standard nominal flow rate [l/min]	→ Page
5/2-way or 3/2-way valve, convertible, single solenoid					
	VSNC-FC-M52-MD-G14-F8	G1/4	VDI/VDE 3845 NAMUR 1/4	1250	12
	VSNC-FC-M52-MD-N14-F8	NPT1/4			
5/2-way valve, double solenoid					
	VSNC-F-B52-D-G14-F8	G1/4	VDI/VDE 3845 NAMUR	1350	15
	VSNC-F-B52-D-N14-F8	NPT1/4			
5/3-way valve					
	VSNC-F-P53C-MD-G14-F8	G1/4	VDI/VDE 3845 NAMUR	1250	18
	VSNC-F-P53U-MD-G14-F8	G1/4		950	
	VSNC-F-P53E-MD-G14-F8	G1/4		1050	
	VSNC-F-P53C-MD-N14-F8	NPT1/4		1250	
	VSNC-F-P53-U-MD-N14-F8	NPT1/4		950	
	VSNC-F-P53-E-MD-G14-F8	NPT1/4		1050	

Coils	IP65 Industrial type B							IP65 Type A						
	12 V DC	24 V DC	48 V DC	24 V AC	48 V AC	120 V AC	230 V AC	12 V DC	24 V DC	48 V DC	24 V AC	48 V AC	120 V AC	230 V AC
5/2-way and 3/2-way, single solenoid	■	■ Part No.	■	■	■	■	■	■	■ Part No.	■	■	■	■	■
5/2-way, double solenoid	■	■ Part No.	■	■	■	■	■	■	■ Part No.	■	■	■	■	■
5/3 G	■	■	■	■	■	■	■	■	■	■	■	■	■	■
5/3 B	■	■	■	■	■	■	■	■	■	■	■	■	■	■
5/3 E	■	■	■	■	■	■	■	■	■	■	■	■	■	■

■ = Can be combined using a modular system
 Part No.= Can be ordered with part number as a fast seller

Solenoid valves VSNC

Peripherals overview – VSNC-...-F8

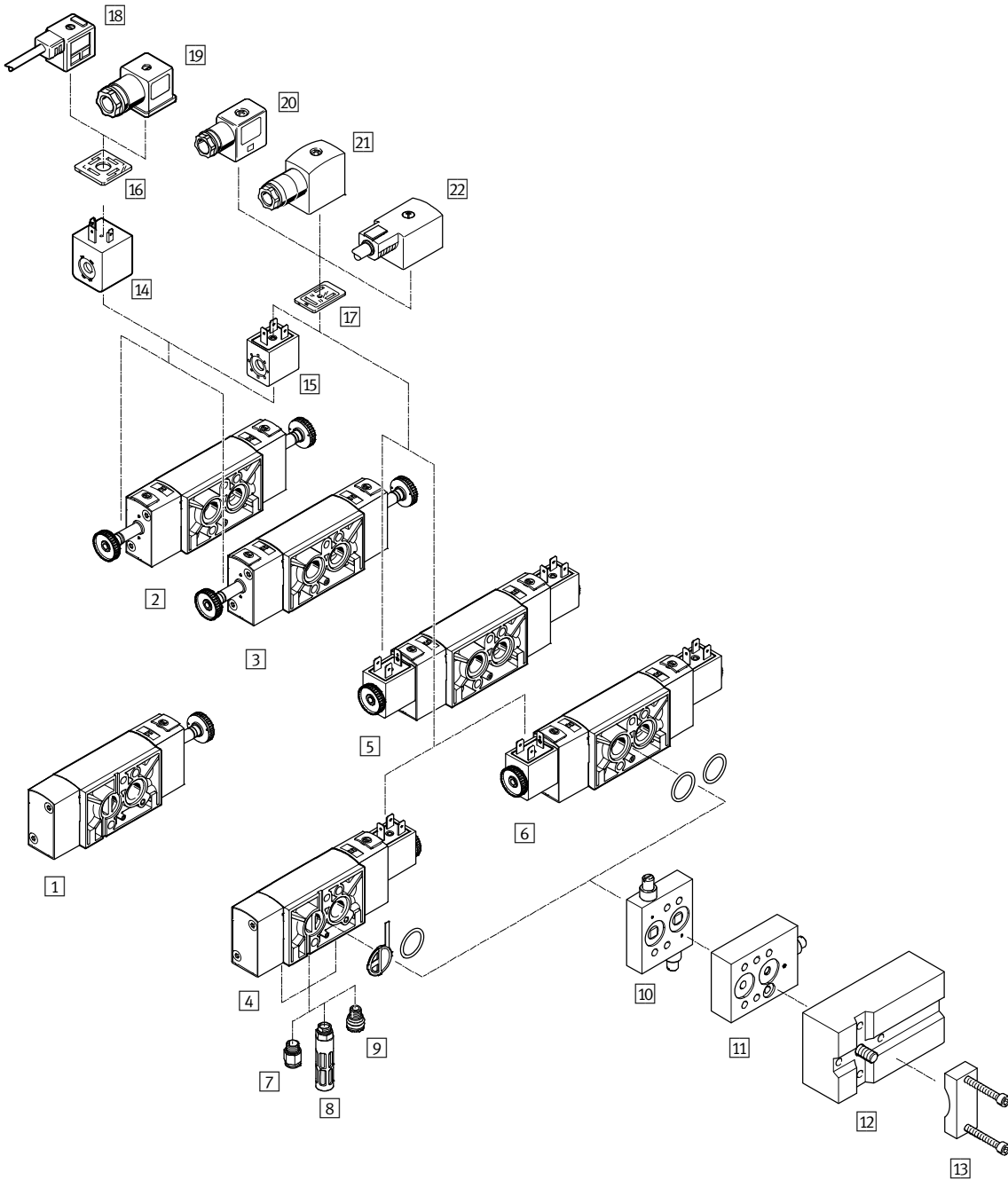

Solenoid valves VSNC

Peripherals overview – VSNC-...-F8

Mounting components and accessories			
	Brief description	→ Page/Internet	
1	VSNC-...-F8 Solenoid valves	3/2-way and 5/2-way single solenoid valve with converting seal, plastic cover cap and brass armature tube, for controlling single- or double-acting actuators	12
2	VSNC-...-F8 Solenoid valves	5/2-way double solenoid valve with plastic cover cap and brass armature tube, for controlling double-acting actuators	15
3	VSNC-...-F8 Solenoid valves	5/3-way valve, normally open, closed or exhausted, with plastic cover cap and brass armature tube, for controlling double-acting actuators	18
4	VSNC-...-F8 Solenoid valves	3/2-way and 5/2-way single solenoid valve with converting seal, plastic cover cap, brass armature tube and 24 V DC solenoid coil, for controlling single- or double-acting actuators	12
5	VSNC-...-F8 Solenoid valves	5/2-way double solenoid valve with plastic cover cap, brass armature tube and 24 V DC solenoid coil, for controlling double-acting actuators	15
6	VSNC-...-F8 Solenoid valves	5/3-way valve, normally open, closed or exhausted, with plastic cover cap, brass armature tube and 24 V DC solenoid coil, for controlling double-acting actuators	18
7	QS Push-in fitting	For connecting compressed air tubing with standard outside diameters	40
8	U Silencer	–	40
9	VABD-D3-SN-G14 Exhaust protection	Exhaust protection to IP65. The spring chamber of the actuator is protected against the ingress of aggressive ambient air and water by the one-way flow control system	39
10	VABF-S7-F1B1P2-F Flow control plate	Exhaust air flow control plate for NAMUR interface for installation between the solenoid valve and double-acting actuators	37
11	VABF-S7-F1B5P1-F Flow control plate	Exhaust air flow control plate for NAMUR interface for installation between the solenoid valve and single-acting drives	37
12	VABF-S7-S-G14 Connection plate kit	Mounting plate for attaching the valve to a NAMUR rib	38
13	VAME-S7-Y Mounting bracket	Alternative option (instead of screw) of attaching the valve to a NAMUR rib with the help of a mounting bracket	38
14	VACF-A Solenoid coil	Electrical connection to DIN EN 175301-803, type A	–
15	VACF-B Solenoid coil	Electrical connection to Festo standard for MSSD-F	39
16	MC-LD Illuminating seal	Illuminating seal for displaying the switching status	40
17	MF-LD Illuminating seal	Illuminating seal for displaying the switching status	40
18	KMC Connecting cable	–	40
19	MSSD-C Plug socket	Electrical connection to DIN EN 175301-803, type A	40
20	MSSD-F Plug socket	Electrical connection to Festo standard with screw terminal connection	40
21	MSSD-F-S Plug socket	Electrical connection to Festo standard with insulation displacement connection	40
22	KMF Connecting cable	–	kmf

Solenoid valves VSNC

Key features and product range overview – VSNC-...-FN

VSNC-FN

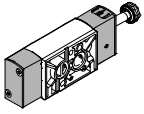

- Valve cover cap material: Aluminium/metal
- Armature material: Stainless steel
- Pilot air (incoming air of armature tube), protected

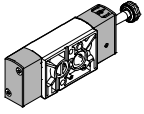
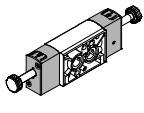
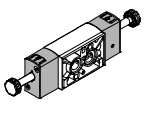
Version	Type	Pneumatic connection 1, 3, 5	Pneumatic connection 2, 4, based on standard	Standard nominal flow rate [l/min]	→ Page
3/2-way or 5/2-way valve -...-FN, convertible, single solenoid					
	VSNC-FC-M52-MD-G14-FN	G1/4	VDI/VDE 3845 NAMUR	1250	22
	VSNC-FC-M52-MD-N14-FN	NPT1/4-18			
	VSNC-FC-M52-MD-G14-FN-1A1-EX4-A	G1/4			
	VSNC-FC-M52-MD-N14-FN-1A1-EX4-A	NPT1/4-18			
5/2-way valve -...-FN, double solenoid					
	VSNC-F-B52-D-G14-FN	G1/4	VDI/VDE 3845 NAMUR	1350	26
	VSNC-F-B52-D-N14-FN	NPT1/4-18			
	VSNC-F-B52-D-G14-FN-1A1-EX4-A	G1/4			
	VSNC-F-B52-D-N14-FN-1A1-EX4-A	NPT1/4-18			
5/3-way valve -...-FN					
	VSNC-F-P53C-MD-G14-FN	G1/4	VDI/VDE 3845 NAMUR	1250	30
	VSNC-F-P53U-MD-G14-FN			950	
	VSNC-F-P53E-MD-G14-FN			1050	
	VSNC-F-P53C-MD-N14-FN	NPT1/4-18		1250	
	VSNC-F-P53U-MD-N14-FN			950	
	VSNC-F-P53E-MD-N14-FN			1050	

Solenoid valves VSNC

Key features and product range overview – VSNC-...-FN

Coils	IPT 65			Ex-nA			Ex-ia	Ex-mb			AEx-m		
	24 V DC	120 V AC	230 V AC	24 V DC	120 V AC	230 V AC	24 ... 32 V DC	24 V DC	120 V AC	230 V AC	24 V DC	120 V AC	230 V AC
5/2-way and 3/2-way, single solenoid	■ Part No.	■	■	■	■	■	■ Part No.	■ Part No.	■	■	■ Part No.	■ Part No.	■
5/2-way, double solenoid	■ Part No.	■	■	■	■	■	■ Part No.	■ Part No.	■	■	■ Part No.	■ Part No.	■
5/3 G	■	■	■	■	■	■	■	■	■	■	■	■	■
5/3 B	■	■	■	■	■	■	■	■	■	■	■	■	■
5/3 E	■	■	■	■	■	■	■	■	■	■	■	■	■

■ = Can be combined using a modular system
 Part No.= Can be ordered with part number as a fast seller

Intrinsically safe coils VACN-...-Ex4A



- Category II 2G II 2D
- Type of ignition protection Ex-ia
- IEC Ex certification
- ATEX certification

Non-sparking coils VACN-...-Ex2N



- Category II 3G II 3D
- Type of ignition protection nA
- ATEX certification

Encapsulated coils VACN-...-Ex4M



- Category II 2G II 2D
- Type of ignition protection Ex-m
- IEC Ex certification
- ATEX certification

Encapsulated coils with conduit, connection VACN-...-U4M



- Class I; Div I
- Type of ignition protection AEx-...-m
- FM approval

Solenoid valves VSNC

Peripherals overview – VSNC-...-FN

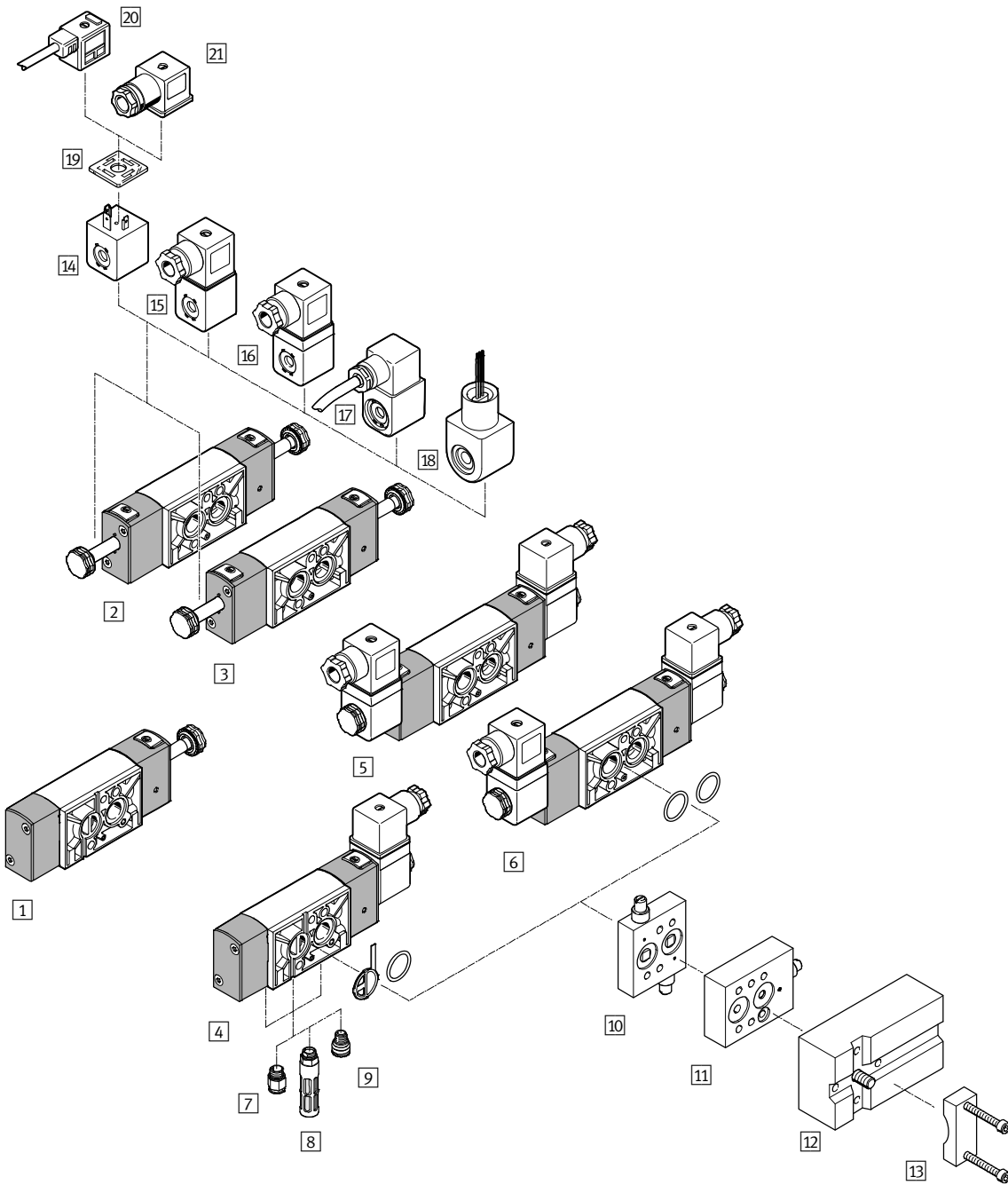

Solenoid valves VSNC

Peripherals overview – VSNC-...-FN

Mounting components and accessories			
	Brief description	→ Page/Internet	
1	VSNC-...-FN Solenoid valves	3/2-way and 5/2-way single solenoid valve with converting seal, aluminium cover cap and stainless steel armature tube, for controlling single- or double-acting actuators	22
2	VSNC-...-FN Solenoid valves	5/2-way double solenoid valve with aluminium cover cap and stainless steel armature tube, for controlling double-acting actuators	26
3	VSNC-...-FN Solenoid valves	5/3-way valve, normally open, closed or exhausted, with aluminium cover cap and stainless steel armature tube, for controlling double-acting actuators	30
4	VSNC-...-FN Solenoid valves	3/2-way and 5/2-way single solenoid valve with converting seal, aluminium cover cap, stainless steel armature tube and Ex-ia solenoid coil, for controlling single- or double-acting actuators	22
5	VSNC- ... -FN Solenoid valves	5/2-way double solenoid valve with aluminium cover cap, stainless steel armature tube and Ex-ia solenoid coil, for controlling double-acting actuators	26
6	VSNC- ... -FN Solenoid valves	5/3-way valve, normally open, closed or exhausted, with aluminium cover cap, stainless steel armature tube and Ex-ia solenoid coil, for controlling double-acting actuators	30
7	QS Push-in fitting	For connecting compressed air tubing with standard outside diameters	40
8	U Silencer	–	40
9	VABD-D3-SN-G14 Exhaust protection	Exhaust protection to IP65. The spring chamber of the actuator is protected against the ingress of aggressive ambient air and water by the one-way flow control system	39
10	VABF-S7-F1B5P2-F Flow control plate	Exhaust air flow control plate for NAMUR interface for installation between the solenoid valve and double-acting actuators	37
11	VABF-S7-F1B5P1-F Flow control plate	Exhaust air flow control plate for NAMUR interface for installation between the solenoid valve and single-acting drives	37
12	VABF-S7-S-G14 Connection plate kit	Mounting plate for attaching the valve to a NAMUR rib	38
13	VAME-S7-Y Mounting bracket	Alternative option (instead of screw) of attaching the valve to a NAMUR rib with the help of a mounting bracket	38
14	VACN-N Solenoid coil	Electrical connection to DIN EN 175301-803, type A	–
15	VACN-N- ... -Ex2-N Solenoid coil	Type of ignition protection nA = non-sparking, for use in zone 2	–
16	VACN-N- ... -Ex4-A Solenoid coil	Type of ignition protection iA = intrinsically safe, for use in zone 1	–
17	VACN-N- ... -Ex4-M Solenoid coil	Type of ignition protection m = encapsulated, for use in zone 1	–
18	VACN-N- ... -U4-M Solenoid coil	Type of ignition protection m = encapsulated, for use in Class I, Div I (American FM approval to NEC 500)	–
19	MC-LD Illuminating seal	Illuminating seal for displaying the switching status	40
20	KMC Connecting cable	–	kmc
21	MSSD-C Plug socket	Electrical connection to DIN EN 175301-803, type A	40

Solenoid valves VSNC

Type codes

Nominal operating voltage						
	None					
1A	24 V AC/50-60 Hz					
3A	230 V AC/50-60 Hz					
3W	230 V AC/240 V AC/50-60 Hz					
7A	48 V AC/50-60 Hz					
16B	120 V AC/60 Hz and 110 V AC/50-60 Hz					
1	24 V DC					
4	5 V DC					
5	12 V DC					
7	48 V DC					
Electrical connection						
	None					
A1	Connecting cable type A, to EN 175301					
B2	Connecting cable type B, industry standard					
C3	Cable, 3 m					
K11	Cable with insulating conduit connection					
Degree of protection for electrics						
	Standard					
S8	IP67					
EU certification						
	None					
EX1	II 3G					
EX2	II 3GD					
EX3	II 2G					
EX4	II 2GD					
Approval						
	None					
C1	CSA mark (Canada)					
U1	cULus, normal environment, USA and Canada					
U4	Class 1 Div 1 to NEC 500					
Type of ignition protection						
	None					
A	Intrinsically safe					
M	Encapsulation					
N	Non-sparking					
Electrical accessories, valve						
	None					
G	Connector socket without LED					
GS	Connector socket, with protective circuit					

Solenoid valves VSNC

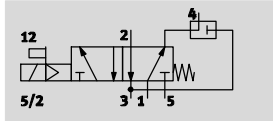

Technical data – 3/2-way or 5/2-way valve, convertible, single solenoid

Function¹⁾
5/2-way valve

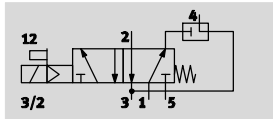

3/2-way valve
with exhaust return



-  - Voltage
24 V DC
-  - Operating pressure
2.5 ... 10 bar
-  - Temperature range
-20 ... 60 °C



¹⁾ Can be converted by exchanging the seal plate

General technical data		VSNC-FC-M52-MD-G14-F8 VSNC-FC-M52-MD-N14-F8	VSNC-FC-M52-MD-G14-F8-1B2
Valve function		3/2-way or 5/2-way, convertible	
Width	[mm]	32	
Design		Piston spool valve	
Sealing principle		Soft	
Actuation type		Electric	
Reset method		Mechanical spring	
Type of pilot control		Piloted	
Manual override		Detenting, non-detenting	
Type of mounting		With through-hole	
Mounting position		Any	
Max. tightening torque of valve mounting	[Nm]	3.2	
Non-overlapping		Yes	
Switching status display		-	Yes, with socket
Nominal flow rate 1 → 2	[l/min]	1200	
b value		0.4	
C value	[l/sbar]	5.2	
Pneumatic connection	1, 3, 5 2, 4	G1/4, NPT-1/418 Port pattern to NAMUR	
Conforms to standard		VDI/VDE 3845 NAMUR	
Product weight	[g]	333	387

Solenoid valves VSNC

Technical data – 3/2-way or 5/2-way valve, convertible, single solenoid

Operating and environmental conditions		
	VSNC-FC-M52-MD-G14-F8 VSNC-FC-M52-MD-N14-F8	VSNC-FC-M52-MD-G14-F8-1B2
Operating medium	Compressed air to ISO 8573-1:2010 [7:4:4]	
Note on operating/pilot medium	Lubricated operation possible (in which case lubricated operation will always be required)	
Operating pressure [bar]	2.5 ... 10	
Ambient temperature [°C]	–20 ... 60	
Temperature of medium [°C]	–20 ... 60	
Corrosion resistance class CRC ¹⁾	2	

1) Corrosion resistance class CRC 2 to Festo standard FN 940070
Moderate corrosion stress. Indoor applications in which condensation may occur. External visible parts with primarily decorative requirements for the surface and which are in direct contact with the ambient atmosphere typical for industrial applications.

Electrical data		
	VSNC-FC-M52-MD-G14-F8 VSNC-FC-M52-MD-N14-F8	VSNC-FC-M52-MD-G14-F8-1B2
Electrical connection	–	3-pin push-in connector, type B to industry standard (11 mm)
Coil characteristics, 24 V DC [W]	–	3.3
Permissible voltage fluctuations [%]	–	±10
Duty cycle [%]	–	100
Degree of protection	–	IP65
Switching time on [ms]	11	
Switching time off [ms]	38	

Materials	
1) Housing	Wrought aluminium alloy
2) Seals	NBR
–	RoHS-compliant

Solenoid valves VSNC

Technical data – 3/2-way or 5/2-way valve, convertible, single solenoid

Dimensions

Download CAD data → www.festo.com

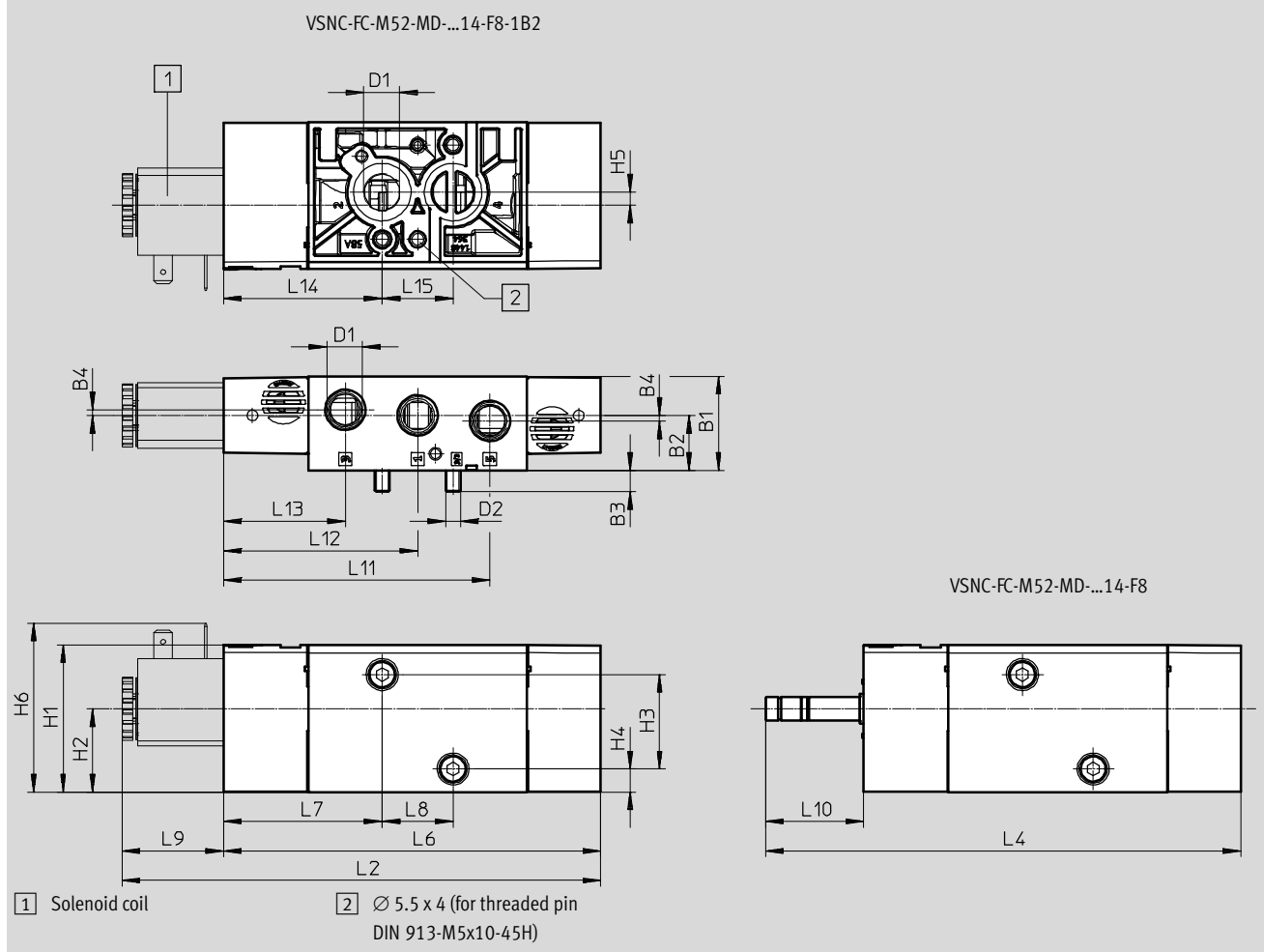

Type	B1	B2	B3	B4	D1	D2	H1	H2	H3	H4	H5	H6
VSNC-FC-M52-MD-G14-F8	31.8	18.6	7.3	1.9	G $\frac{1}{4}$	M5	49.9	28.2	32	7.8	4.4	-
VSNC-FC-M52-MD-N14-F8					NPT $\frac{1}{4}$ -18							57.2
VSNC-FC-M52-MD-G14-F8-1B2					G $\frac{1}{4}$							

Type	L2	L4	L6	L7	L8	L9	L10	L11	L12	L13	L14	L15
VSNC-FC-M52-MD-G14-F8	162.2	161.1	127.8	53.8	24	34.4	33.3	90.3	65.8	41.3	53.8	24
VSNC-FC-M52-MD-N14-F8												
VSNC-FC-M52-MD-G14-F8-1B2												

Ordering data – Valves

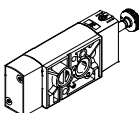
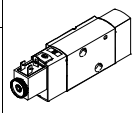
Solenoid valve			Solenoid valve with socket		
	Part No.	Type		Part No.	Type
	577257	VSNC-FC-M52-MD-G14-F8		577295	VSNC-FC-M52-MD-G14-F8-1B2
	577262	VSNC-FC-M52-MD-N14-F8			

Solenoid valves VSNC

Technical data – 5/2-way valve, double solenoid

Function
5/2-way valve

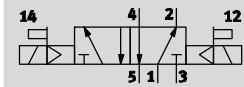

Voltage
24 V DC



Operating pressure
1.5 ... 10 bar



Temperature range
-20 ... 60 °C

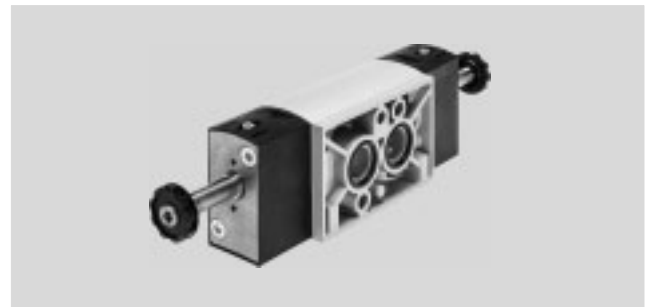

General technical data		VSNC-F-B52-D-G14-F8 VSNC-F-B52-D-N14-F8	VSNC-F-B52-D-G14-F8-1B2
Valve function		5/2-way, double solenoid	
Width	[mm]	32	
Nominal size DN	[mm]	7.2	
Design		Piston spool valve	
Sealing principle		Soft	
Actuation type		Electric	
Type of reset		-	
Type of pilot control		Piloted	
Manual override		Detenting, non-detenting	
Type of mounting		With through-hole	
Mounting position		Any	
Max. tightening torque of valve mounting	[Nm]	3.2	
Non-overlapping		Yes	
Nominal flow rate 1 → 2	[l/min]	1200	
b value		0.4	
C value	[l/sbar]	5.6	
Pneumatic connection	1, 3, 5 2, 4	G1/4, NPT1/4-18 Port pattern to NAMUR	
Conforms to standard		VDI/VDE 3845 (NAMUR)	
Product weight	[g]	345	455

Solenoid valves VSNC

Technical data – 5/2-way valve, double solenoid

Operating and environmental conditions		
	VSNC-F-B52-D-G14-F8 VSNC-F-B52-D-N14-F8	VSNC-F-B52-D-G14-F8-1B2
Operating medium	Compressed air to ISO 8573-1:2010 [7:4:4]	
Note on operating/pilot medium	Lubricated operation possible (in which case lubricated operation will always be required)	
Operating pressure [bar]	1.5 ... 10	
Ambient temperature [°C]	–20 ... 60	
Temperature of medium [°C]	–20 ... 60	
Corrosion resistance class CRC ¹⁾	2	

1) Corrosion resistance class CRC 2 to Festo standard FN 940070
Moderate corrosion stress. Indoor applications in which condensation may occur. External visible parts with primarily decorative requirements for the surface and which are in direct contact with the ambient atmosphere typical for industrial applications.

Electrical data		
	VSNC-F-B52-D-G14-F8 VSNC-F-B52-D-N14-F8	VSNC-F-B52-D-G14-F8-1B2
Electrical connection	–	3-pin push-in connector, to industry standard (11 mm), type B
Coil characteristics, 24 V DC [W]	See solenoid coil, to be ordered separately	3.3
Permissible voltage fluctuations [%]	–	±10
Degree of protection	–	IP65, IP67
Switching time on [ms]	11	

Materials		
1) Housing	Wrought aluminium alloy	
2) Seals	NBR	
–	RoHS-compliant	

Solenoid valves VSNC

Technical data – 5/2-way valve, double solenoid

Dimensions

Download CAD data → www.festo.com

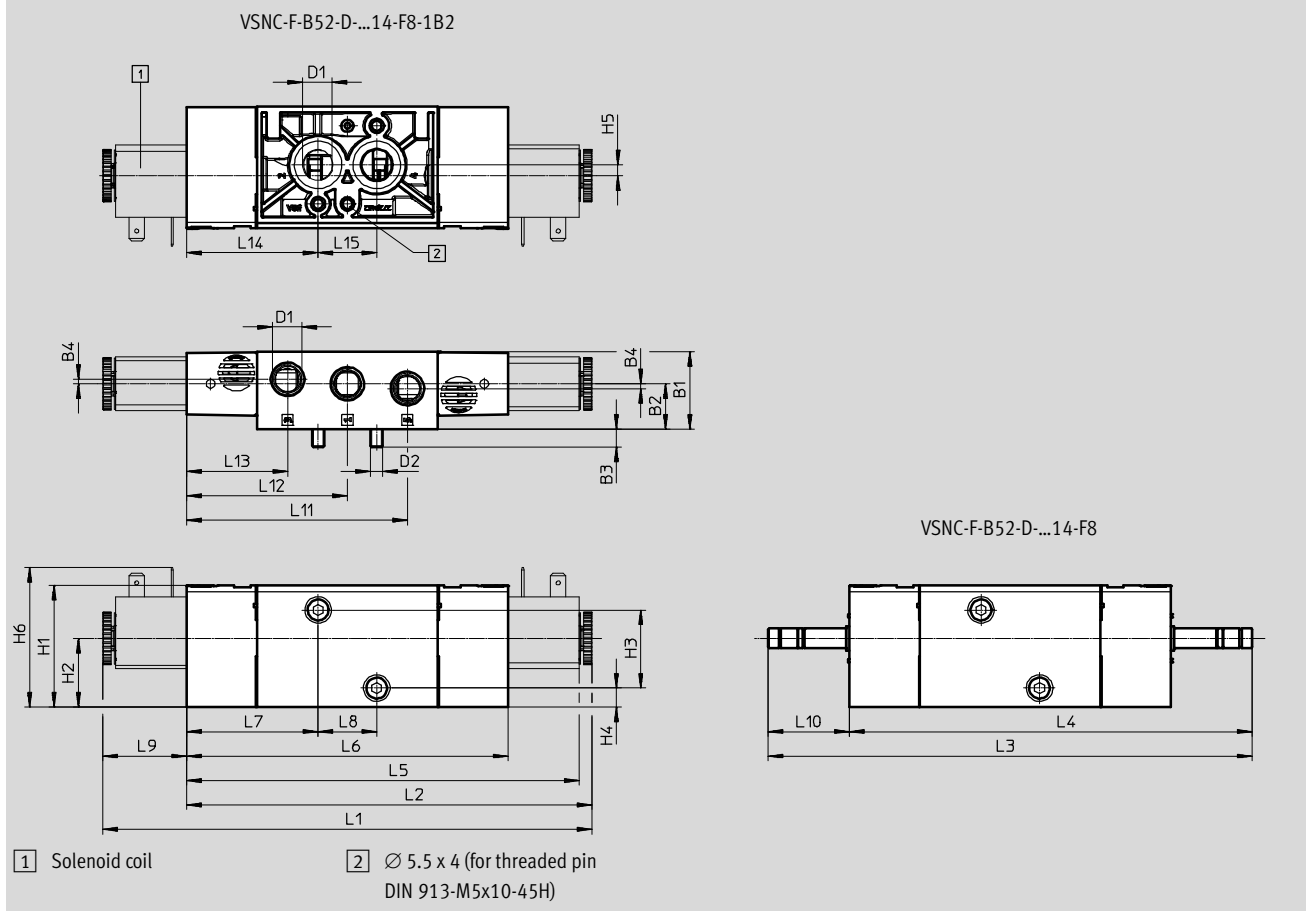

Type	B1	B2	B3	B4	D1	D2	H1	H2	H3	H4	H5	H6	L1	L2
VSNC-F-B52-D-G14-F8	31.8	18.6	7.3	1.9	G1/4	M5	49.9	28.2	32	7.8	4.4	-	-	-
VSNC-F-B52-D-N14-F8					NPT1/4-18									
VSNC-F-B52-D-G14-F8-1B2					G1/4									

Type	L3	L4	L5	L6	L7	L8	L9	L10	L11	L12	L13	L14	L15
VSNC-F-B52-D-G14-F8	198.2	164.9	-	131.6	53.8	24	-	33.3	90.3	65.8	41.3	53.8	24
VSNC-F-B52-D-N14-F8			160.6										
VSNC-F-B52-D-G14-F8-1B2			34.4										

Ordering data – Valves

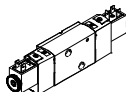
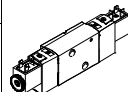
Solenoid valve		Solenoid valve	
Part No.	Type	Part No.	Type
	577258 VSNC-F-B52-D-G14-F8		577296 VSNC-F-B52-D-G14-F8-1B2
	577263 VSNC-F-B52-D-N14-F8		

Solenoid valves VSNC

Technical data – 5/3-way valve

Function

5/3-way valve, closed

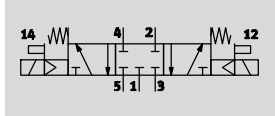

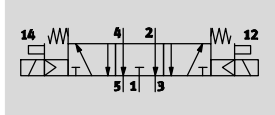

5/3-way valve, exhausted

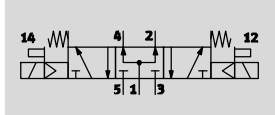

5/3-way valve, pressurised



 - Operating pressure
3 ... 10 bar

 - Temperature range
-20 ... 60 °C



General technical data				
		VSNC-F-P53C-MD-G14-F8 VSNC-F-P53C-MD-N14-F8	VSNC-F-P53E-MD-G14-F8 VSNC-F-P53E-MD-N14-F8	VSNC-F-P53U-MD-G14-F8 VSNC-F-P53U-MD-N14-F8
Valve function		5/3-way, closed	5/3-way, exhausted	5/3-way, pressurised
Width	[mm]	32		
Nominal width	[mm]	7.2	6	6
Design		Piston spool valve		
Sealing principle		Soft		
Actuation type		Electric		
Reset method		Mechanical spring		
Type of pilot control		Piloted		
Manual override		Non-detenting, non-detenting		
Type of mounting		With through-hole		
Mounting position		Any		
Max. tightening torque of valve mounting	[Nm]	3.5		
Non-overlapping		Yes		
Nominal flow rate	1 → 2 [l/min]	1200	800	800
b value		0.4	0.4	0.5
C value	[l/sbar]	5.2	4.4	2.1
Pneumatic connection	1, 3, 5 2, 4	G1/4, NPT1/4-18		
Conforms to standard		Port pattern to NAMUR		
Product weight	[g]	345		

Solenoid valves VSNC

Technical data – 5/3-way valve

Operating and environmental conditions			
	VSNC-F-P53C-MD-G14-F8 VSNC-F-P53C-MD-N14-F8	VSNC-F-P53E-MD-G14-F8 VSNC-F-P53E-MD-N14-F8	VSNC-F-P53U-MD-G14-F8 VSNC-F-P53U-MD-N14-F8
Operating medium	Compressed air to ISO 8573-1:2010 [7:4:4]		
Note on operating/pilot medium	Lubricated operation possible (in which case lubricated operation will always be required)		
Operating pressure [bar]	3 ... 10		
Ambient temperature [°C]	-20 ... 60		
Temperature of medium [°C]	-20 ... 60		
Corrosion resistance class CRC ¹⁾	2		

1) Corrosion resistance class CRC 2 to Festo standard FN 940070
Moderate corrosion stress. Indoor applications in which condensation may occur. External visible parts with primarily decorative requirements for the surface and which are in direct contact with the ambient atmosphere typical for industrial applications.

Electrical data			
	VSNC-F-P53C-MD-G14-F8 VSNC-F-P53C-MD-N14-F8	VSNC-F-P53E-MD-G14-F8 VSNC-F-P53E-MD-N14-F8	VSNC-F-P53U-MD-G14-F8 VSNC-F-P53U-MD-N14-F8
Coil characteristics [W]	See solenoid coil, to be ordered separately		
Switching time on [ms]	13	14	14
Switching time off [ms]	42	48	48
Changeover time [ms]	26	25	25

Materials	
1) Housing	Wrought aluminium alloy
2) Seals	NBR
-	RoHS-compliant

Solenoid valves VSNC

Technical data – 5/3-way valve

Dimensions

Download CAD data → www.festo.com

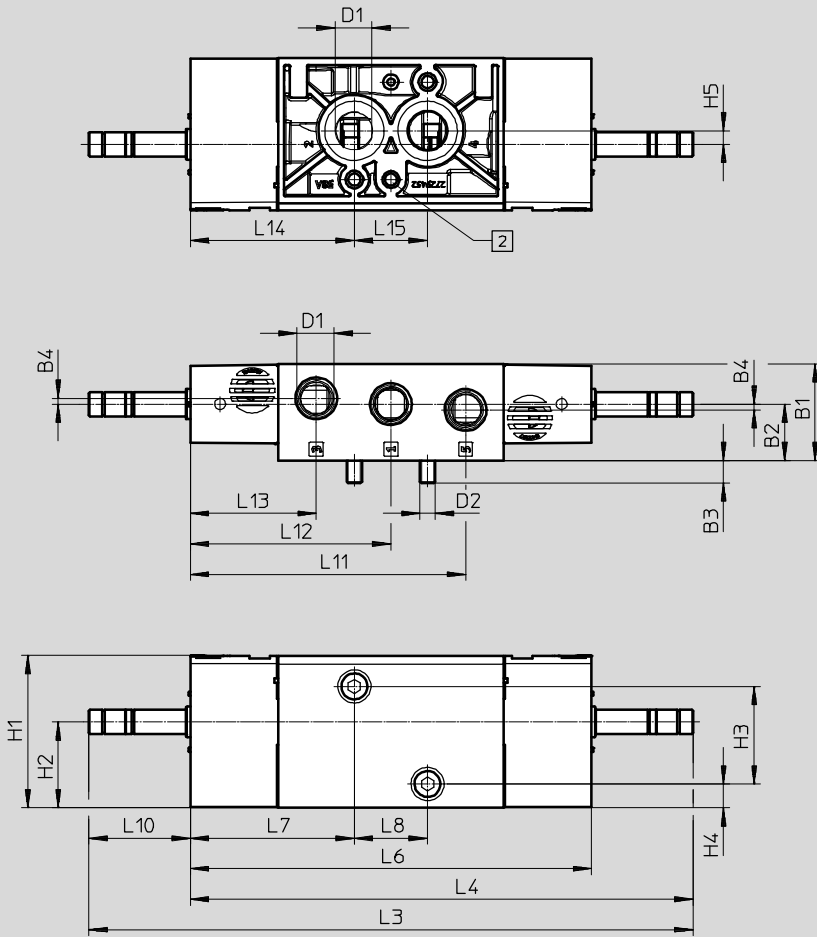

2 ∅ 5.5 x 4 (for threaded pin
DIN 913-M5x10-45H)

Type	B1	B2	B3	B4	D1	D2	H1	H2	H3	H4	H5
VSNC-F-P53C-MD-G14-F8	31.8	18.6	7.3	1.9	G1/4	M5	49.9	28.2	32	7.8	4.4
VSNC-F-P53U-MD-G14-F8											
VSNC-F-P53E-MD-G14-F8											
VSNC-F-P53C-MD-N14-F8											
VSNC-F-P53U-MD-N14-F8											
VSNC-F-P53E-MD-N14-F8											

Type	L3	L4	L6	L7	L8	L10	L11	L12	L13	L14	L15
VSNC-F-P53C-MD-G14-F8	198.2	164.9	131.6	53.8	24	33.3	90.3	65.8	41.3	53.8	24
VSNC-F-P53U-MD-G14-F8											
VSNC-F-P53E-MD-G14-F8											
VSNC-F-P53C-MD-N14-F8											
VSNC-F-P53U-MD-N14-F8											
VSNC-F-P53E-MD-N14-F8											

Solenoid valves VSNC

Technical data – 5/3-way valve

Ordering data – Valves

Solenoid valve

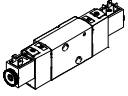
	Part No.	Type
	577259	VSNC-F-P53C-MD-G14-F8
	577260	VSNC-F-P53U-MD-G14-F8
	577261	VSNC-F-P53E-MD-G14-F8
	577264	VSNC-F-P53C-MD-N14-F8
	577265	VSNC-F-P53U-MD-N14-F8
	577266	VSNC-F-P53E-MD-N14-F8

Solenoid valves VSNC

Technical data – 3/2-way or 5/2-way -...-FN, convertible, single solenoid

Function

3/2-way or 5/2-way valve,
convertible

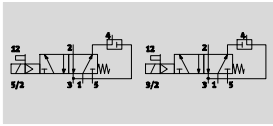

 - Operating pressure
2.5 ... 10 bar

 - Temperature range
-20 ... 60 °C



General technical data		VSNC-FC-M52-MD-G14-FN VSNC-FC-M52-MD-N14-FN	VSNC-FC-M52-MD-G14-FN-1A1-EX4-A VSNC-FC-M52-MD-N14-FN-1A1-EX4-A
Valve function		3/2-way or 5/2-way, convertible	
Width	[mm]	32	
Design		Piston spool valve	
Sealing principle		Soft	
Actuation type		Electric	
Reset method		Mechanical spring	
Type of pilot control		Piloted	
Pilot air supply		Internal	
Exhaust air function		With flow control	
Manual override		Non-detenting, detenting	
Type of mounting		With through-hole	
Connection for vent opening		Not ducted	
Mounting position		Any	
Non-overlapping		Yes	
Nominal flow rate	1 → 2 [l/min]	1250	
	Exhaust return 4 → 3 [l/min]	110	
b value		0.4	
C value	[l/sbar]	5.2	
Pneumatic connection	1, 3, 5	G1/4, NPT1/4-18	
	2, 4	Port pattern to NAMUR	
Conforms to standard		VDI/VDE 3845 (NAMUR)	
Product weight	[g]	419	

Operating and environmental conditions		VSNC-FC-M52-MD-G14-FN VSNC-FC-M52-MD-N14-FN	VSNC-FC-M52-MD-G14-FN-1A1-EX4-A VSNC-FC-M52-MD-N14-FN-1A1-EX4-A
Operating medium		Compressed air to ISO 8573-1:2010 [7:4:4]	
Note on operating/pilot medium		Lubricated operation possible (in which case lubricated operation will always be required)	
Operating pressure	[bar]	2.5 ... 10	
Ambient temperature	[°C]	-20 ... 60	
Temperature of medium	[°C]	-20 ... 60	
Corrosion resistance class CRC ¹⁾		2	

1) Corrosion resistance class CRC 2 to Festo standard FN 940070
Moderate corrosion stress. Indoor applications in which condensation may occur. External visible parts with primarily decorative requirements for the surface and which are in direct contact with the ambient atmosphere typical for industrial applications.

Solenoid valves VSNC

Technical data – 3/2-way or 5/2-way -...-FN, convertible, single solenoid

ATEX		
	VSNC-FC-M52-MD-G14-FN VSNC-FC-M52-MD-N14-FN	VSNC-FC-M52-MD-G14-FN-1A1-EX4-A VSNC-FC-M52-MD-N14-FN-1A1-EX4-A
ATEX category gas	–	II 2G
Explosion ignition protection type for gas	–	Ex ia IIC T6 Ga
ATEX category dust	–	II 2D
Explosion ignition protection type for dust	–	Ex t IIIC T80°C Db
Explosion protection certification outside the EU	–	EPL Db (IEC-EX)
	–	EPL Ga (IEC-EX)
Explosion-proof temperature [°C]	–	-40 °C ≤ Ta ≤ +50 °C
Degree of protection	–	IP65
	–	IP67
CE marking (see declaration of conformity)	To EU Explosion Protection Directive (ATEX)	

Electrical data		
	VSNC-FC-M52-MD-G14-FN VSNC-FC-M52-MD-N14-FN	VSNC-FC-M52-MD-G14-FN-1A1-EX4-A VSNC-FC-M52-MD-N14-FN-1A1-EX4-A
Electrical connection	–	Type A, to EN 175301-803
Coil characteristics, 24 V DC [W]	See solenoid coil, to be ordered separately	
Coil characteristics, 24 V DC [W]	3.3	
Switching time on [ms]	24	
Switching time off [ms]	92	
Permissible voltage fluctuations [%]	–	± 10

Materials	
1 Housing	Wrought aluminium alloy
2 Seals	NBR
–	RoHS-compliant

Solenoid valves VSNC

Technical data – 3/2-way or 5/2-way -...-FN, convertible, single solenoid

Dimensions

Download CAD data → www.festo.com

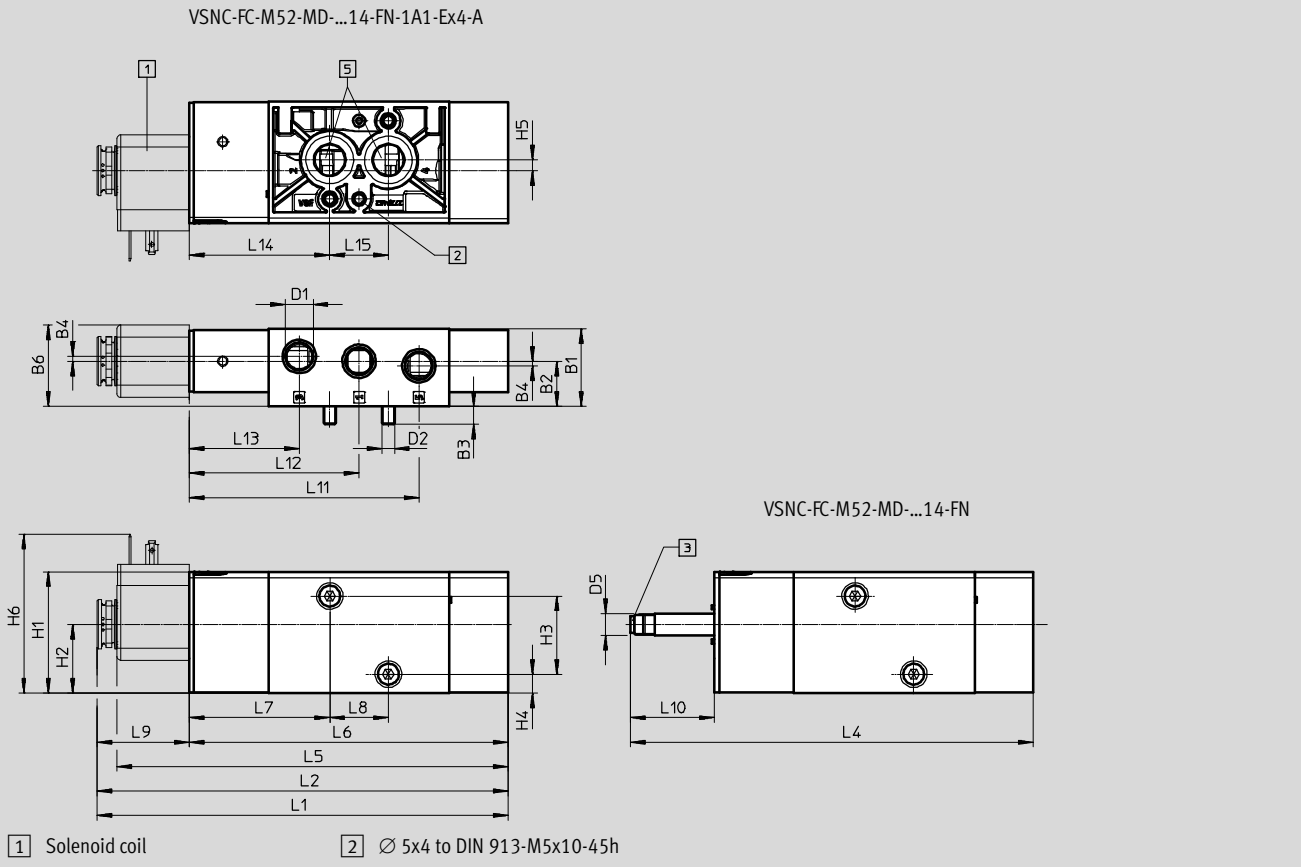

Type	B1	B2	B3	B4	B6	D1	D2	D5 - \varnothing	H1	H2	H3	H4	H5	H6
VSNC-FC-M52-MD-G14-FN	31.8	18.6	7.3	1.9	33.4	G $\frac{1}{4}$	M5	9	49.8	28.2	32	7.8	4.4	-
VSNC-FC-M52-MD-G14-FN-1A1-Ex4-A														65.1
VSNC-FC-M52-MD-N14-FN						-								
VSNC-FC-M52-MD-N14-FN-1A1-Ex4-A						65.1								

Type	L2	L4	L5	L6	L7	L8	L9	L10	L11	L12	L13	L14	L15
VSNC-FC-M52-MD-G14-FN	-	165	-	130.6	57.6	24	-	34.4	94.1	69.6	45.1	57.6	24
VSNC-FC-M52-MD-G14-FN-1A1-Ex4-A	168.3		160.1				37.7						
VSNC-FC-M52-MD-N14-FN	-		-				-						
VSNC-FC-M52-MD-N14-FN-1A1-Ex4-A	168.3		160.1				37.7						

Solenoid valves VSNC

Technical data – 3/2-way or 5/2-way -...-FN, convertible, single solenoid

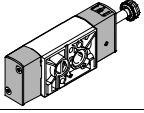
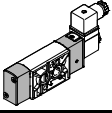
Ordering data – Valves		
Solenoid valve		
	Part No.	Type
	577267	VSNC-FC-M52-MD-G14-FN
	577272	VSNC-FC-M52-MD-N14-FN
	577281	VSNC-FC-M52-MD-G14-FN-1A1-Ex4-A
	577286	VSNC-FC-M52-MD-N14-FN-1A1-Ex4-A

Solenoid valves VSNC

Technical data – 5/2-way -...-FN, double solenoid

Function

5/2-way valve, double solenoid

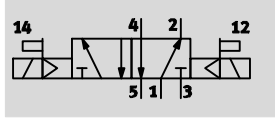

 - Operating pressure
1.5 ... 10 bar

 - Temperature range
-20 ... 60 °C



General technical data		VSNC-F-B52-D-G14-FN VSNC-F-B52-D-N14-FN	VSNC-F-B52-D-G14-FN-1A1-EX4-A VSNC-F-B52-D-N14-FN-1A1-EX4-A
Valve function		5/2-way, double solenoid	
Width	[mm]	32	
Design		Piston spool valve	
Sealing principle		Soft	
Actuation type		Electric	
Type of pilot control		Piloted	
Pilot air supply		Internal	
Exhaust air function		With flow control	
Manual override		Non-detenting, detenting	
Type of mounting		With through-hole	
Connection for vent opening		Not ducted	
Mounting position		Any	
Non-overlapping		Yes	
Nominal flow rate	[l/min]	1350	
b value		0.4	
C value	[l/sbar]	5.6	
Pneumatic connection	1, 3, 5 2, 4	G1/4, NPT1/4-18 Port pattern to NAMUR	
Conforms to standard		VDI/VDE 3845 (NAMUR)	
Product weight	[g]	461	

Operating and environmental conditions		VSNC-F-B52-D-G14-FN VSNC-F-B52-D-N14-FN	VSNC-F-B52-D-G14-FN-1A1-EX4-A VSNC-F-B52-D-N14-FN-1A1-EX4-A
Operating medium		Compressed air to ISO 8573-1:2010 [7:4:4]	
Note on operating/pilot medium		Lubricated operation possible (in which case lubricated operation will always be required)	
Operating pressure	[bar]	1.5 ... 10	
Ambient temperature	[°C]	-20 ... 60	
Temperature of medium	[°C]	-20 ... 60	
Corrosion resistance class CRC ¹⁾		2	

1) Corrosion resistance class CRC 2 to Festo standard FN 940070
Moderate corrosion stress. Indoor applications in which condensation may occur. External visible parts with primarily decorative requirements for the surface and which are in direct contact with the ambient atmosphere typical for industrial applications.

Solenoid valves VSNC

Technical data – 5/2-way -...-FN, double solenoid

ATEX		
	VSNC-F-B52-D-G14-FN VSNC-F-B52-D-N14-FN	VSNC-F-B52-D-G14-FN-1A1-Ex4-A VSNC-F-B52-D-N14-FN-1A1-Ex4-A
ATEX category gas	–	II 2G
Explosion ignition protection type for gas	–	Ex ia IIC T6 Ga
ATEX category dust	–	II 2D
Explosion ignition protection type for dust	–	Ex t IIIIC T80°C Db
Explosion protection certification outside the EU	–	EPL Db (IEC-EX)
	–	EPL Ga (IEC-EX)
Explosion-proof temperature [°C]	–	–40 °C ≤ Ta ≤ +50 °C
Degree of protection	–	IP65
	–	IP67
CE marking (see declaration of conformity)	To EU Explosion Protection Directive (ATEX)	

Electrical data		
	VSNC-F-B52-D-G14-FN VSNC-F-B52-D-N14-FN	VSNC-F-B52-D-G14-FN-1A1-Ex4-A VSNC-F-B52-D-N14-FN-1A1-Ex4-A
Electrical connection	–	Type A, to EN 175301-803
Coil characteristics, 24 V DC [W]	See solenoid coil, to be ordered separately	
Changeover time [ms]	20	
Permissible voltage fluctuations [%]	–	± 10

Materials	
1 Housing	Wrought aluminium alloy
2 Seals	NBR
–	RoHS-compliant

Solenoid valves VSNC

Technical data – 5/2-way -...-FN, double solenoid

Dimensions

Download CAD data → www.festo.com

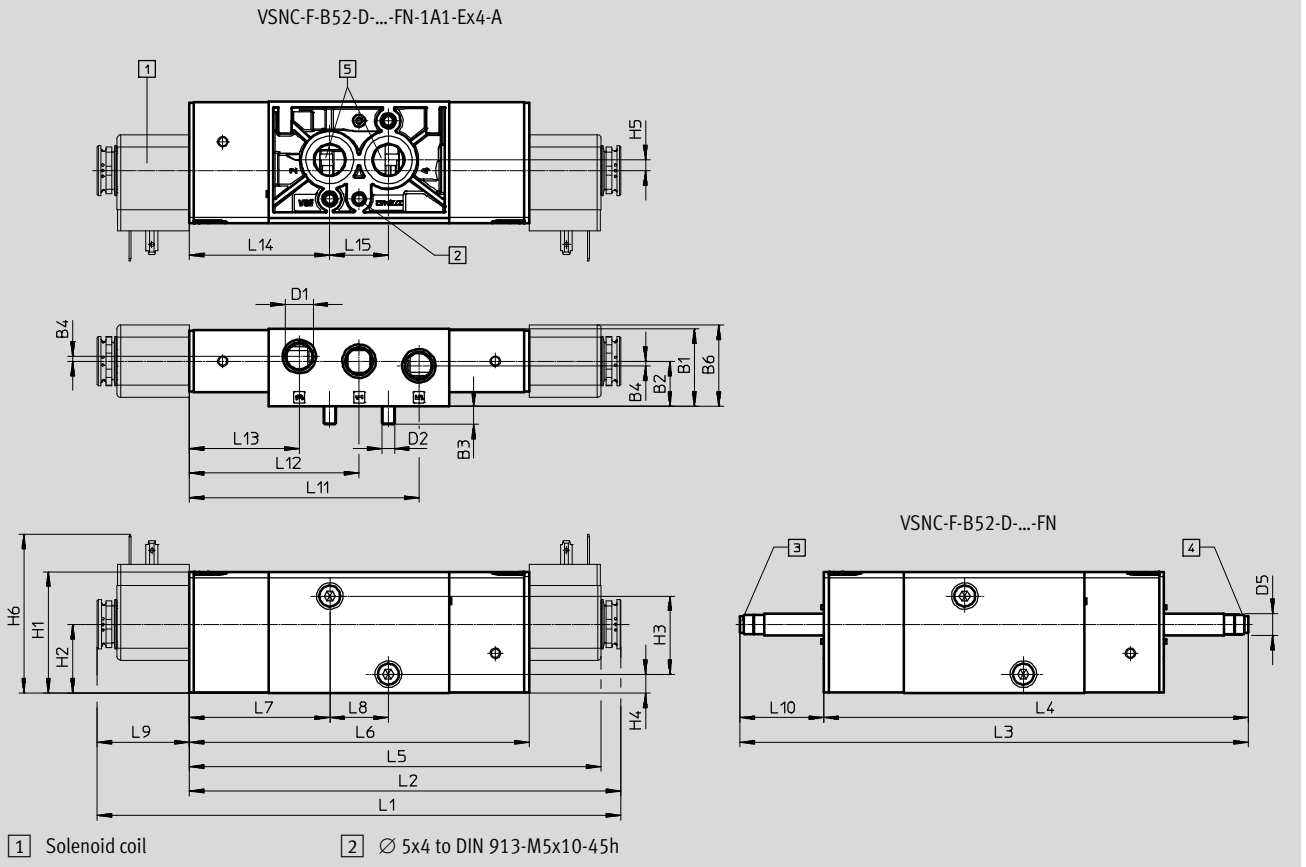

Type	B1	B2	B3	B4	B6	D1	D2	D5 Ø	H1	H2	H3	H4	H5	H6	L1
VSNC-F-B52-D-G14-FN	31.8	18.6	7.3	1.9	33.4	G¼	M5	9	49.8	28.2	32	7.8	4.4	-	-
VSNC-F-B52-D-G14-FN-1A1-Ex4-A						65.1								214.5	
VSNC-F-B52-D-N14-FN						-								-	
VSNC-F-B52-D-N14-FN-1A1-Ex4-A						65.1								214.5	

Type	L2	L3	L4	L5	L6	L7	L8	L9	L10	L11	L12	L13	L14	L15
VSNC-F-B52-D-G14-FN	-	208	173.6	-	139.2	57.6	24	-	34.4	94.1	69.6	45.1	57.6	24
VSNC-F-B52-D-G14-FN-1A1-Ex4-A	176.9			168.7				37.7						
VSNC-F-B52-D-N14-FN	-			-				-						
VSNC-F-B52-D-N14-FN-1A1-Ex4-A	176.9			168.7				37.7						

Solenoid valves VSNC

Technical data – 5/2-way -...-FN, double solenoid

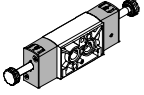
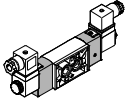
Ordering data – Valves		
Solenoid valve		
	Part No.	Type
	577268	VSNC-F-B52-D-G14-FN
	577273	VSNC-F-B52-D-N14-FN
	577282	VSNC-F-B52-D-G14-FN-1A1-Ex4-A
	577287	VSNC-F-B52-D-N14-FN-1A1-Ex4-A

Solenoid valves VSNC

Technical data – 5/3-way -...-FN

Function

5/3-way valve, closed

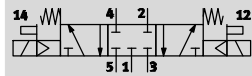

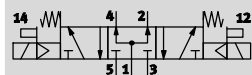

5/3-way valve, exhausted



5/3-way valve, pressurised



 - Operating pressure
3 ... 10 bar

 - Temperature range
-20 ... 60 °C



General technical data				
		VSNC-F-P53C-MD-G14-FN VSNC-F-P53C-MD-N14-FN	VSNC-F-P53U-MD-G14-FN VSNC-F-P53U-MD-N14-FN	VSNC-F-P53E-MD-G14-FN VSNC-F-P53E-MD-N14-FN
Valve function		5/3		
		Closed	Pressurised	Exhausted
Width	[mm]	32		
Design		Piston spool valve		
Sealing principle		Soft		
Actuation type		Electric		
Reset method		Mechanical spring		
Type of pilot control		Piloted		
Pilot air supply		Internal		
Exhaust air function		With flow control		
Manual override		Non-detenting, detenting		
Type of mounting		With through-hole		
Connection for vent opening		Not ducted		
Mounting position		Any		
Non-overlapping		Yes		
Nominal flow rate	[l/min]	1250	950	1050
b value		0.4	0.5	0.4
C value	[l/sbar]	5.2	2.1	4.4
Pneumatic connection	1, 3, 5 2, 4	G1/4, NPT1/4-18		
Conforms to standard		Port pattern to NAMUR		
		VDI/VDE 3845 (NAMUR)		
Product weight	[g]	461		

Solenoid valves VSNC

Technical data – 5/3-way -...-FN

Operating and environmental conditions			
	VSNC-F-P53C-MD-G14-FN VSNC-F-P53C-MD-N14-FN	VSNC-F-P53U-MD-G14-FN VSNC-F-P53U-MD-N14-FN	VSNC-F-P53E-MD-G14-FN VSNC-F-P53E-MD-N14-FN
Operating medium	Compressed air to ISO 8573-1:2010 [7:4:4]		
Note on operating/pilot medium	Lubricated operation possible (in which case lubricated operation will always be required)		
Operating pressure [bar]	3 ... 10		
Ambient temperature [°C]	-20 ... 60		
Temperature of medium [°C]	-20 ... 60		
Corrosion resistance class CRC ¹⁾	2		

1) Corrosion resistance class CRC 2 to Festo standard FN 940070
 Moderate corrosion stress. Indoor applications in which condensation may occur. External visible parts with primarily decorative requirements for the surface and which are in direct contact with the ambient atmosphere typical for industrial applications.

Electrical data			
	VSNC-F-P53C-MD-G14-FN VSNC-F-P53C-MD-N14-FN	VSNC-F-P53U-MD-G14-FN VSNC-F-P53U-MD-N14-FN	VSNC-F-P53E-MD-G14-FN VSNC-F-P53E-MD-N14-FN
Coil characteristics [W]	See solenoid coil, to be ordered separately		
Switching time on [ms]	23		
Switching time off [ms]	103		
Changeover time [ms]	55		

Materials	
1) Housing	Wrought aluminium alloy
2) Seals	NBR
-	RoHS-compliant

Solenoid valves VSNC

Technical data – 5/3-way -...-FN

Dimensions

Download CAD data → www.festo.com

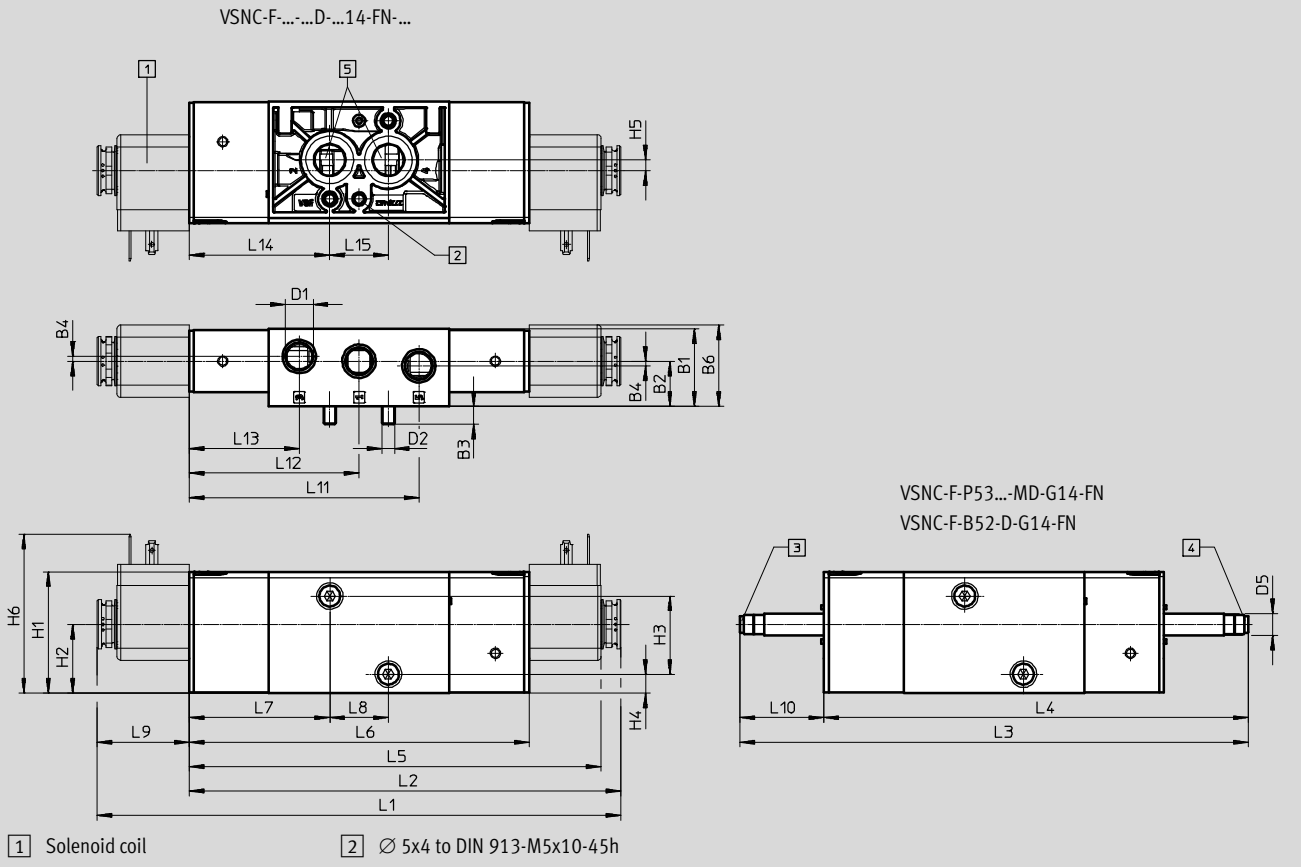

Type	B1	B2	B3	B4	B6	D1	D2	D5 ∅	H1	H2	H3	H4	H5	H6	L1
VSNC-F-P53C-MD-G14-FN	31.8	18.6	7.3	1.9	33.4	G¼	M5	9	49.8	28.2	32	7.8	4.4	-	-
VSNC-F-P53U-MD-G14-FN															
VSNC-F-P53E-MD-G14-FN						N¼									
VSNC-F-P53C-MD-N14-FN															
VSNC-F-P53U-MD-N14-FN															
VSNC-F-P53E-MD-N14-FN															

Type	L2	L3	L4	L5	L6	L7	L8	L9	L10	L11	L12	L13	L14	L15
VSNC-F-P53C-MD-G14-FN	-	208	173.6	-	139.2	57.6	24	-	34.4	94.1	69.6	45.1	57.6	24
VSNC-F-P53U-MD-G14-FN														
VSNC-F-P53E-MD-G14-FN														
VSNC-F-P53C-MD-N14-FN														
VSNC-F-P53U-MD-N14-FN														
VSNC-F-P53E-MD-N14-FN														

Solenoid valves VSNC

Technical data – 5/3-way -...-FN

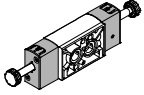
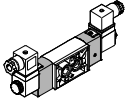
Ordering data – Valves		
Solenoid valve		
	Part No.	Type
	577269	VSNC-F-P53C-MD-G14-FN
	577270	VSNC-F-P53U-MD-G14-FN
	577271	VSNC-F-P53E-MD-G14-FN
	577274	VSNC-F-P53C-MD-N14-FN
	577275	VSNC-F-P53U-MD-N14-FN
	577276	VSNC-F-P53E-MD-N14-FN

Solenoid valves VSNC

Ordering data – Modular product system

Modular product system					
Module no.	Product type		Design principle		Reset method for single solenoid valves
	Type of directional control valve		Valve function		
8026033	VSNC series C	- Flanged valve	- Piston spool	- 5/2-way valve, double solenoid - 5/2-way valve, single solenoid - 5/3-way valve, mid-position closed - 5/3-way valve, mid-position exhausted - 5/3-way valve, mid-position pressurised	- None - Mechanical spring
Ordering example 8026033	VSNC	-	-	-	-

Ordering table					
Solenoid valve VSNC			Condi- tions	Code	Entry code
Module no.	8026033				
Product type	VSNC series C			VSNC	VSNC
Type of directional control valve	Flanged valve			-F	
Design principle	Piston spool				
Valve function	5/2-way valve, double solenoid		1	-B52	
	5/2-way valve, single solenoid			-M52	
	5/3-way valve, mid-position closed		1, 2	-P53C	
	5/3-way valve, mid-position exhausted		1, 2	-P53E	
	5/3-way valve, mid-position pressurised		1, 2	-P53U	
Reset method for single solenoid valves	None				
	Mechanical spring		9	-M	

- 1** B52, P53C, P53E, P53U not convertible in combination with (additional function) valve function (C)
- 2** P53C, P53E, P53U, F8 not in combination with (design principle) poppet valve (T)
- 9** Mandatory data in combination with (valve function) 5/2-way valve, single solenoid (-M52)
Mandatory data in combination with (valve function) 5/3-way valve, mid-position closed (-P53C)
Mandatory data in combination with (valve function) 5/3-way valve, mid-position exhausted (-P53E)
Mandatory data in combination with (valve function) 5/3-way valve, mid-position pressurised (-P53U)
Not in combination with (valve function) 5/2-way valve, double solenoid (-B52)

Transfer order code

		-		-		-	
--	--	---	--	---	--	---	--

Solenoid valves VSNC

Ordering data – Modular product system

Modular product system				
Manual override		Exhaust		Nominal operating voltage
Pneumatic connection		Valve pilot control interface		
- Non-detenting, detenting without accessory	- G $\frac{1}{4}$	- Without fitting	- With armature tube 8 mm, long	- None
- Non-detenting	- NPT $\frac{1}{4}$	- With fitting		- 24 V DC
- Covered	- Push-in connector 6 mm	- Silencer with metal housing		- 24 V AC/50-60 Hz
	- Push-in connector 8 mm	- Silencer with polymer housing		- 230 V AC/50-60 Hz
	- Push-in connector 10 mm			12 V DC
	- Push-in connector $\frac{1}{4}$			- 120 V AC/60 Hz and
	- Push-in connector $\frac{3}{8}$			110 V AC/50-60 Hz
	- Push-in connector 5/16			

Ordering table				
Solenoid valve VSNC		Condi- tions	Code	Entry code
Manual override	Non-detenting, detenting without accessories		-D	
	Non-detenting		-H	
	Covered		-S	
Pneumatic connection	G $\frac{1}{4}$		-G14	
	N $\frac{1}{4}$ NPT		-N14	
	Push-in connector 6 mm		-Q6	
	Push-in connector 8 mm		-Q8	
	Push-in connector 10 mm		-Q10	
	Push-in connector $\frac{1}{4}$		-T14	
	Push-in connector $\frac{3}{8}$		-T38	
	Push-in connector 5/16		-T516	
Exhaust	Without fitting			
	With fitting	[31]	-QN	
	Silencer with metal housing		-U1	
	Silencer with polymer housing	[17]	-U3	
Valve pilot control interface	With armature tube 8 mm long	[2]	-F8	
Nominal operating voltage	None	[19], [21]		
	24 V DC		-1	
	24 V AC/50-60 Hz	[3]	-1 A	
	230 V AC/50-60 Hz	[25]	-3 A	
	12 V DC	[3]	-5	
	120 V AC/60 Hz and 110 V AC/50-60 Hz		-16B	

- [2] P53C, P53E, P53U, F8 not in combination with (design principle) poppet valve (T)
- [3] 1A, 3W, 4, 5, 7, 7A, B2, S8 not in combination with valve pilot control interface with armature tube 9 mm -FN
- [17] U3 not in combination with pneumatic connection -N14, t14, t38, t516
- [19] Nominal operating voltage is mandatory data if electrical connection selected
- [21] Mandatory data if electrical accessories selected
- [25] Not in combination (with valve pilot control interface) with armature tube 8 mm long -F8
- [31] QN not in combination with nominal operating voltage 24 V AC/50-60 Hz

Transfer order code

- - - - -

Solenoid valves VSNC

Ordering data – Modular product system

→ **Modular product system**

Electrical connection		EU certification	
Degree of protection for electrics		Electrical accessories, valve	
- None - Port pattern type B, industry standard	- Standard - IP67	- None	- None - Connector socket without LED
-	-	-	-

Ordering table		Condi- tions	Code	Entry code
Solenoid valve VSNC				
M Electrical connection	None	20		
	Connection arrangement type B, industry standard	3, 10	-B2	
Degree of protection for electrics	Standard			
	IP67	3	-S8	
EU certification	None			
Electrical accessories, valve	None	23, 24		
	Connector socket, without LED	4, 8, 13, 22	+G	

- 3 1A, 3W, 4, 5, 7, 7A, B2, S8 not in combination with valve pilot control interface with armature tube 9 mm -FN
- 4 Not in combination with (electrical connection) cable with insulating conduit connection (K11)
- 8 A, N, G not in combination with (approval) Class1 Div1 to NEC 500 (U4)
- 10 C3, K11, Ex4, U4 A, M, N not in combination with (nominal operating voltage) 24 V AC/50-60 Hz (-1A)
- 13 U4, A, N, G not in combination with (electrical connection) cable, 3 m (C3)
- 20 Mandatory data if electrical connection selected
- 22 G not in combination with type of ignition protection A,M
- 23 Only with nominal operating voltage
- 24 Only with electrical connection

Transfer order code

- - - -

Solenoid valves VSNC

Accessories

Flow control plate

Materials:

Manifold rail: Wrought aluminium alloy

Contains paint-wetting impairment substances, RoHS-compliant

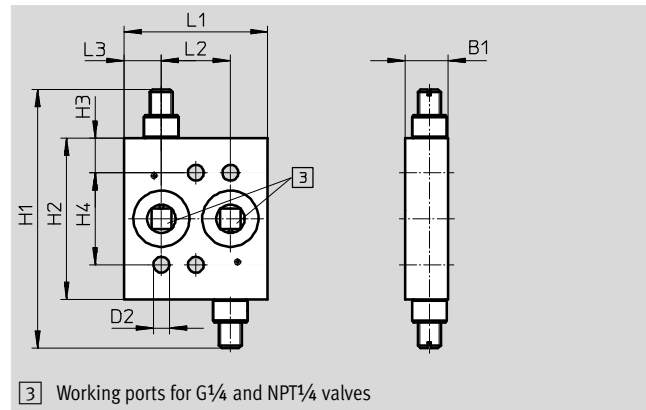
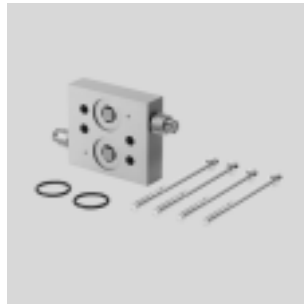

Dimensions [mm] and ordering data										
B1	D2	H1	H2	H3	H4	L1	L2	L3	CRC ¹⁾	Part No. Type
15	5.5	90	56	12	32	50	24	13	3	563395 VABF-S7-F1B1P2-F

1) Corrosion resistance class CRC 3 to Festo standard FN 940070
High corrosion stress. Outdoor exposure under moderate corrosive conditions. External visible parts with primarily functional requirements for the surface and which are in direct contact with a normal industrial environment.

Flow control plate

Materials:

Manifold rail: Wrought aluminium alloy

Contains paint-wetting impairment substances, RoHS-compliant

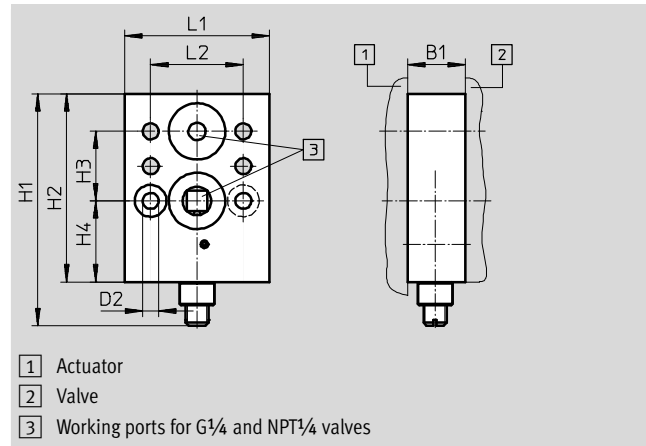

Dimensions [mm] and ordering data										
B1	D2	H1	H2	H3	H4	L1	L2	CRC ¹⁾	Part No. Type	
20	5.5	80	65	24	28	50	32	3	563401 VABF-S7-F1B5P1-F	

1) Corrosion resistance class CRC 3 to Festo standard FN 940070
High corrosion stress. Outdoor exposure under moderate corrosive conditions. External visible parts with primarily functional requirements for the surface and which are in direct contact with a normal industrial environment.

Solenoid valves VSNC

Accessories

Connection plate kit

Materials: Wrought aluminium alloy
Contains paint-wetting impairment substances, RoHS-compliant

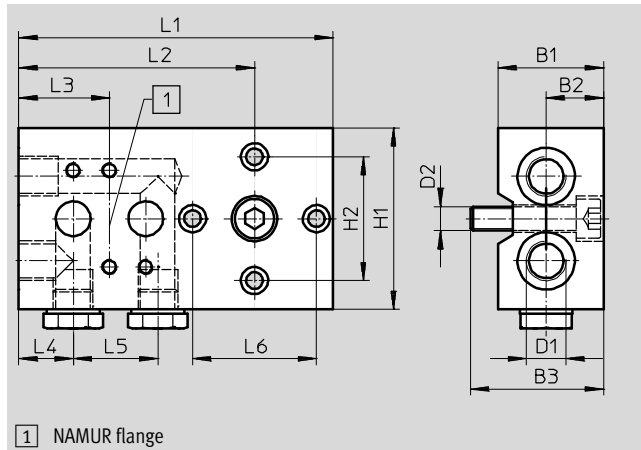

1) NAMUR flange

Dimensions [mm] and ordering data														Part No.	Type
B1	B2	B3	D1	D2	H1	H2	L1	L2	L3	L4	L5	L6	CRC ¹⁾		
35	19	44	G $\frac{1}{4}$	M8	60	41	104	78	30	18	28	41	3	563396	VABS-S7-S-G14

1) Corrosion resistance class CRC 3 to Festo standard FN 940070
High corrosion stress. Outdoor exposure under moderate corrosive conditions. External visible parts with primarily functional requirements for the surface and which are in direct contact with a normal industrial environment.

Mounting bracket

Materials:
Bracket: Wrought aluminium alloy
Contains paint-wetting impairment substances, RoHS-compliant

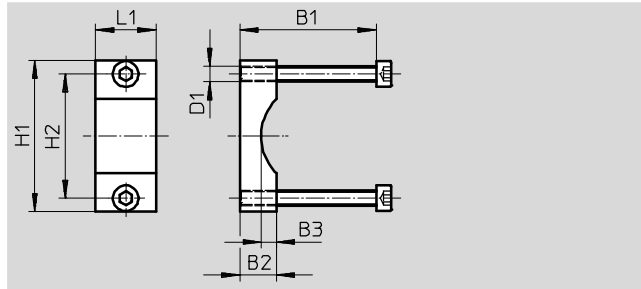

Dimensions [mm] and ordering data									Part No.	Type
B1	B2	B3	D1	H1	H2	L1	CRC ¹⁾			
45/65	12	5	M5	50	41	20	3	563403	VAME-S7-Y	

1) Corrosion resistance class CRC 3 to Festo standard FN 940070
High corrosion stress. Outdoor exposure under moderate corrosive conditions. External visible parts with primarily functional requirements for the surface and which are in direct contact with a normal industrial environment.

Solenoid valves VSNC

Accessories

Exhaust protection

Materials:

EPDM, PA

Contains paint-wetting impairment substances, RoHS-compliant

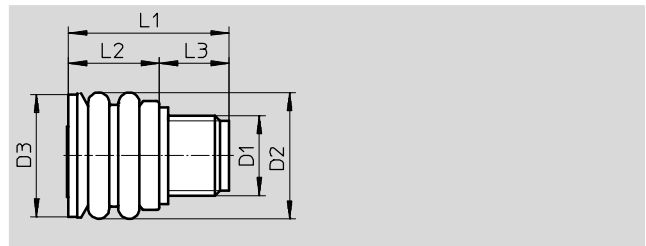





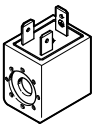

Dimensions [mm] and ordering data							
D1	D2	D3	L1	L2	L3	CRC ¹⁾	Part No. Type
G1/4	21	20.5	26.5	15	11.5	3	563400 VABD-D3-SN-G14

1) Corrosion resistance class CRC 3 to Festo standard FN 940070
 High corrosion stress. Outdoor exposure under moderate corrosive conditions. External visible parts with primarily functional requirements for the surface and which are in direct contact with a normal industrial environment.

Ordering data			
	Description	Part No.	Type
Solenoid coil VACF-B		Technical data → Internet: vacf	
	Electrical connection to Festo standard for MSSD-F	8030801	VACF-B-B2-5
		8030802	VACF-B-B2-1
		8030803	VACF-B-B2-7
		8030804	VACF-B-B2-1A
		8030805	VACF-B-B2-7A
		8030806	VACF-B-B2-16B
		8030808	VACF-B-B2-3W

Solenoid valves VSNC

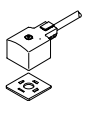
Accessories

Ordering data		Part No.	Type
Plug socket		Technical data → Internet: mssd	
	3-pin, angled socket, square design to DIN EN 175301-803 type B	539710	MSSD-F-M16
	3-pin, IP67 socket to IEC 60529	192746	MSSD-F-S-M16
	–	34583	MSSD-C
Push-in fittings QS		Technical data → Internet: qs	
	–	186108	QS-G1/4-6-I
		186110	QS-G1/4-8-I
		186112	QS-G1/4-10-I
		572320	QB-1/4-1/4-I-U
		572321	QB-1/4-5/16-I-U
		572322	QB-1/4-3/8-I-U
Silencer U		Technical data → Internet: u	
	–	534223	U-1/4-20
		2316	U-1/4
		6842	U-1/4-B
		12639	U-1/4-B-NPT
Connecting cable		Technical data → Internet: kmc	
	–	30931	KMC-1-24 DC-2,5-LED
		30932	KMC-1-230 AC-2,5
		30933	KMC-1-24 DC-5-LED
		30934	KMC-1-230 AC-5
		30935	KMC-1-24-10-LED
Illuminating seal		Technical data → Internet: mc-ld	
	–	19143	MF-LD-12-24 DC
		19144	MF-LD-230 AC
	–	19145	MC-LD-12-24 DC
		19146	MC-LD-230 AC