

Valve series VOFD

FESTO



Solenoid valves VOFD

Key features

FESTO

General information

- The valves in the VOFD series are special 3/2-way valves for the area of process automation for use in chemical and petrochemical plants, where they are frequently used as pilot valves for butterfly valves and drives. Their sturdy design and high resistance to corrosion make these valves suitable for outdoor use under harsh ambient conditions.
- The NAMUR flange pattern makes the solenoid valves especially suitable for quarter-turn actuators. The integrated spring chamber venting protects quarter-turn actuators with spring return (single-acting cylinders and drives) against contaminated ambient air and weather influences such as rain.
- With German Technical Control Board (TÜV) approval up to AK7/SIL-4

Function, design

- 3/2-way directly actuated poppet valves

Safety

- Can be used in emergency shutdown (ESD) applications
- Suitable for use in safety-related systems up to and including SIL4 to IEC 61508

Sturdy

- The surface of the valve housing is treated with hard Ematal. This treatment involves converting the aluminium surface into a very hard aluminium oxide layer with titanium oxide intercalations. This makes the valves very resistant to wear and abrasion and gives them first-class sliding qualities. This provides optimum protection against atmospheric and chemical influences
- You can find information on the media resistance of the product at → www.festo.com

Economical

- One valve, two connection options
- Port pattern to NAMUR for direct mounting of a drive as well as G and NPT threaded connections
- Manual override can be ordered optionally
- Manual override can be retrofitted and removed again – no additional valve version required

VOFD – Basic valves

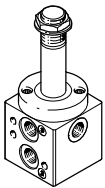

- 3/2-way valves
- G $\frac{1}{4}$, NPT $\frac{1}{4}$ connections
- NAMUR port pattern, NAMUR port pattern with P duct

→ Page 7

VOFD – Solenoid valves

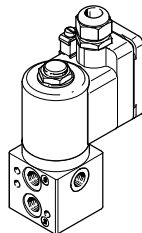

- Combination of VOFD basic valve and VACC-S18 coil
- 3/2-way valves
- Ignition protection types Ex emb II

→ Page 13

Accessories for VOFD valves



- Flow control plates
- Exhaust protection
- Manual override

→ Page 17

Solenoid valves VOFD

Overview of peripherals

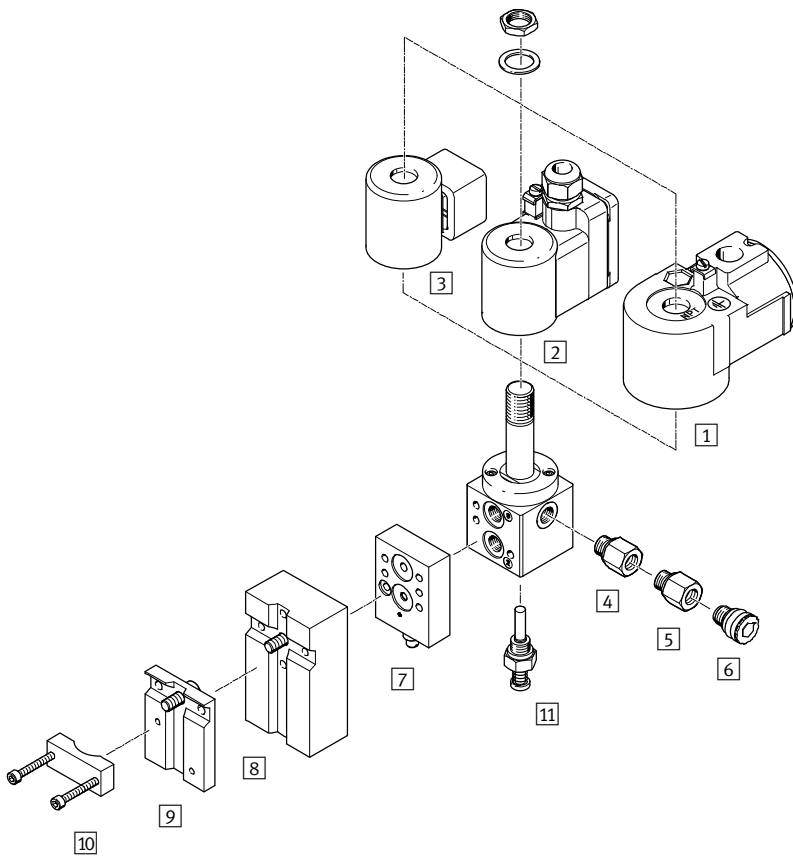

Mounting attachments and accessories			
	Brief description	→ Page/Internet	
1	Solenoid coil VACC-S18	Standard solenoid	19
2	Solenoid coil VACC-S18-me	Ex-emb solenoid	17
3	Solenoid coil VACC-S18-d	Ex-d solenoid	22
4	Adapter NPFV-AF-G14-N14-MF	Adapter from G $\frac{1}{4}$ to NPT $\frac{1}{4}$, with filter	26
5	Adapter NPFV-AF-G14-G14-MF	Adapter from G $\frac{1}{4}$ to G $\frac{1}{4}$, with filter	26
6	Exhaust protection VABD-D3-SN-G14	Exhaust protection to IP65. The spring chamber of drive 8 solenoid valve is protected against the ingress of aggressive ambient air and water by the one-way flow control system	26
7	Flow control plate VABF-S7-F1B5P1-F	Exhaust air flow control plate for NAMUR interface for installation between the solenoid valve and single-acting drives	24
8	Connection plate kit VABF-S7-S-G14	Mounting plate for attaching the valve to a NAMUR rib	25
9	Mounting plate VAME-S7-P	Mounting plate for attaching the valve to a NAMUR rib	24
10	Mounting bracket VAME-S7-Y	Alternative option (instead of screw) for attaching the valve to a NAMUR rib with the help of a mounting bracket	25
11	Hand lever VAOH-S8	Manual override	1178

Solenoid valves VOFD

Type codes

VOFD - LT - M32 - MN - G14 - 1 - A1 -

Type

VOFD	Solenoid valves
------	-----------------

Directional control valve type, design principle

LT	In-line valve, poppet valve
----	-----------------------------

Valve function

M32	Universal valves
-----	------------------

Reset method for single solenoid valves

MN	Mechanical spring without pilot air
----	-------------------------------------

Pneumatic connection

G14	G $\frac{1}{4}$
N14	NPT $\frac{1}{4}$
FG14	NAMUR G $\frac{1}{4}$
FGP14	NAMUR G $\frac{1}{4}$ with P connection

Nominal operating voltage

	Without solenoid coil/not relevant
1	24 V DC
1U	24 V DC and AC
2A	110 V AC/50-60 Hz
2U	110 V DC and AC
3A	230 V AC/50-60 Hz
3U	230 V DC and AC
1A	24 V AC

Electrical connection

A1	Port pattern type A, to EN 175 301
K4	Cable connector M20
F10	Armature tube for solenoid coil 18

Solenoid valves VOFD

Type codes

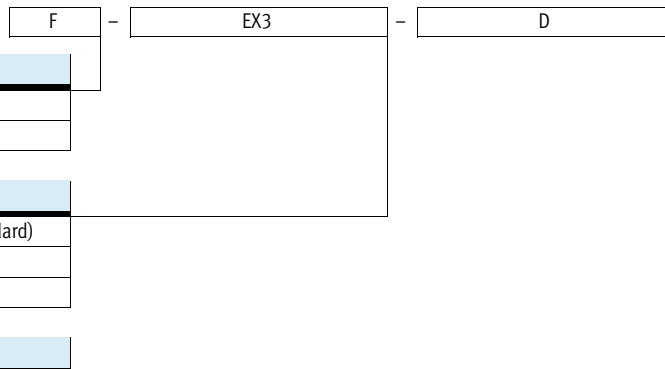

Protective circuit	
	None/standard
F	Fuse

Approval EU, US	
	Approval defined upon introduction (standard)
Ex3	II 2G
Ex4	II 2GD

Explosion protection type	
	None
D	Pressure-resistant encapsulation
ME	Moulded encapsulation, enhanced safety emb

Solenoid coils VACC-S18

Type codes

VACC - S18 - A1 - 1 - F - - -

Type

VACC	Solenoid coil
------	---------------

Solenoid coil type

S18	Shaft 18 mm
-----	-------------

Electrical connection

A1	Port pattern type A, to EN 175 301
K4	Cable connector M20
K5	Cable connector NPT

Nominal operating voltage

1	24 V DC
1A	24 V AC
1U	24 V DC and AC
2A	110 V AC/50-60 Hz
2U	110 V DC and AC
3A	230 V AC/50-60 Hz
3U	230 V DC and AC

Protective circuit

	None
F	Fuse

Approval EU, US

Ex3	II2G
Ex4	II2GD

Explosion protection type

D	Pressure-resistant encapsulation
ME	Moulded encapsulation, enhanced safety
A	Intrinsically safe

Basic valves VOFD

Technical data – 3/2-way valves, G $\frac{1}{4}$ and NAMUR

Function
3/2-way valve

-  - Flow rate
450 l/min

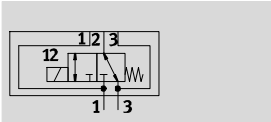
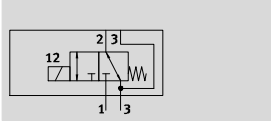

General technical data		G $\frac{1}{4}$ basic valve and NAMUR	G $\frac{1}{4}$ basic valve and NAMUR, P connection
Valve function		3/2-way, closed, single solenoid	
Pneumatic connection	1	G $\frac{1}{4}$	NAMUR port pattern
	2	G $\frac{1}{4}$ and NAMUR port pattern	
	3	G $\frac{1}{4}$	
	4	G $\frac{1}{4}$ and NAMUR port pattern	
Design	Directly actuated poppet valve		
Width	[mm]	51	
Mounting position		Any	
Duty cycle		100%	
Sealing principle		Soft	
Manual override		None	
Reset method		Mechanical spring	
Actuation type		Electric	
Suitable for vacuum		Yes	
Type of control		Direct	
Flow rate for piston valve pressurisation	[m ³ /h]	0.36	
Flow rate for piston valve exhausting	[m ³ /h]	0.36	
Direction of flow		Non-reversible	
Product weight	[g]	560	
Response time off	[ms]	9	
Response time on	[ms]	45	
Nominal size	[mm]	5	
Standard nominal flow rate	[l/min]	450	

Basic valves VOFD

Technical data – 3/2-way valves, G $\frac{1}{4}$ and NAMUR

Operating and environmental conditions		G $\frac{1}{4}$ basic valve and NAMUR	G $\frac{1}{4}$ basic valve and NAMUR, P connection
Operating medium		Compressed air in accordance with ISO 8573-1:2010 [-:-:-]	
Protection class		IP65	
Operating pressure range	[bar]	0 ... 10	
Temperature of medium	[°C]	-10 ... 60	
Ambient temperature	[°C]	-10 ... 60	
Extended ambient temperature, Low Demand mode	[°C]	-25 ... 60	
Safety integrity level [SIL]		Up to SIL 4 Low Demand mode	
		Up to SIL 4 High Demand mode	
Corrosion resistance class CRC ¹⁾		4	

1) Corrosion resistance class 4 according to Festo standard 940 070

Components subject to particularly high corrosion stress. Parts used with aggressive media, e.g. in the food or chemical industry. These applications should be supported with special tests with the media if required.

Materials

Sectional view

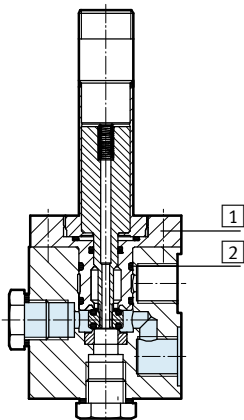

Solenoid valves	G $\frac{1}{4}$ basic valve and NAMUR	G $\frac{1}{4}$ basic valve and NAMUR, P connection
1 Housing	Hard Ematal-anodised aluminium	
2 Seals	Nitrile rubber	
- Note on materials	Contains PWIS (paint-wetting impairment substances), RoHS-compliant	

Basic valves VOFD

Technical data – 3/2-way valves, G $\frac{1}{4}$ and NAMUR

Dimensions – G $\frac{1}{4}$ basic valve and NAMUR

Download CAD data → www.festo.com

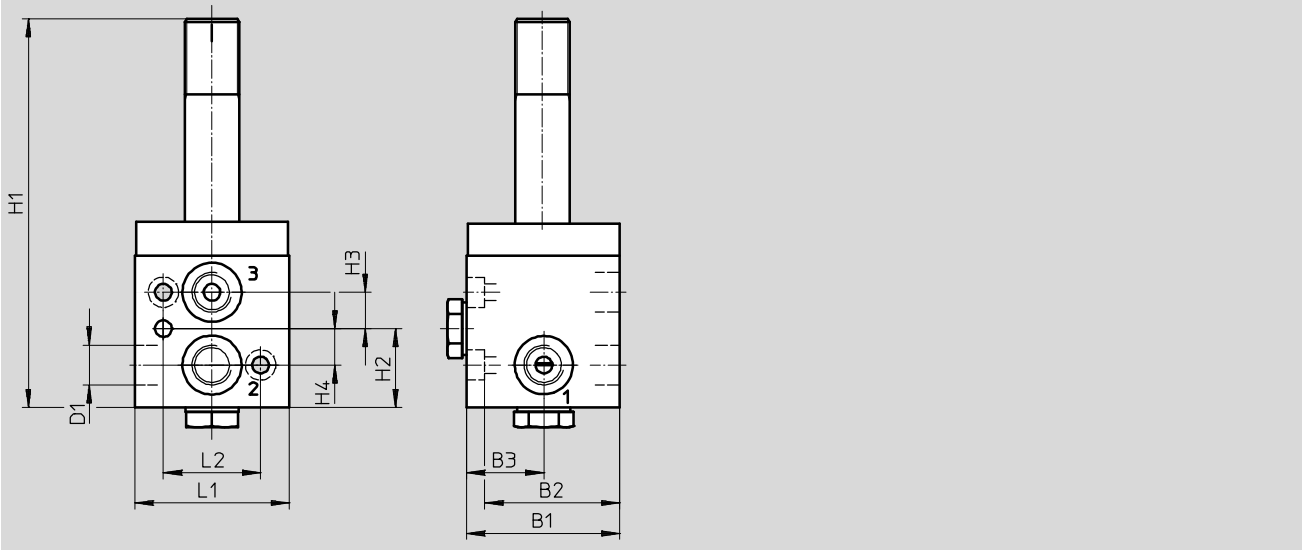

Type	B1	B2	B3	D1	H1	H2	H3	H4	L1	L2
VOFD-LT-M32-MN-FG14-F10	50.5	25.5	25.5	G $\frac{1}{4}$, NAMUR	128.2	26	12	12	51	32

Dimensions – G $\frac{1}{4}$ basic valve and NAMUR, P connection

Download CAD data → www.festo.com

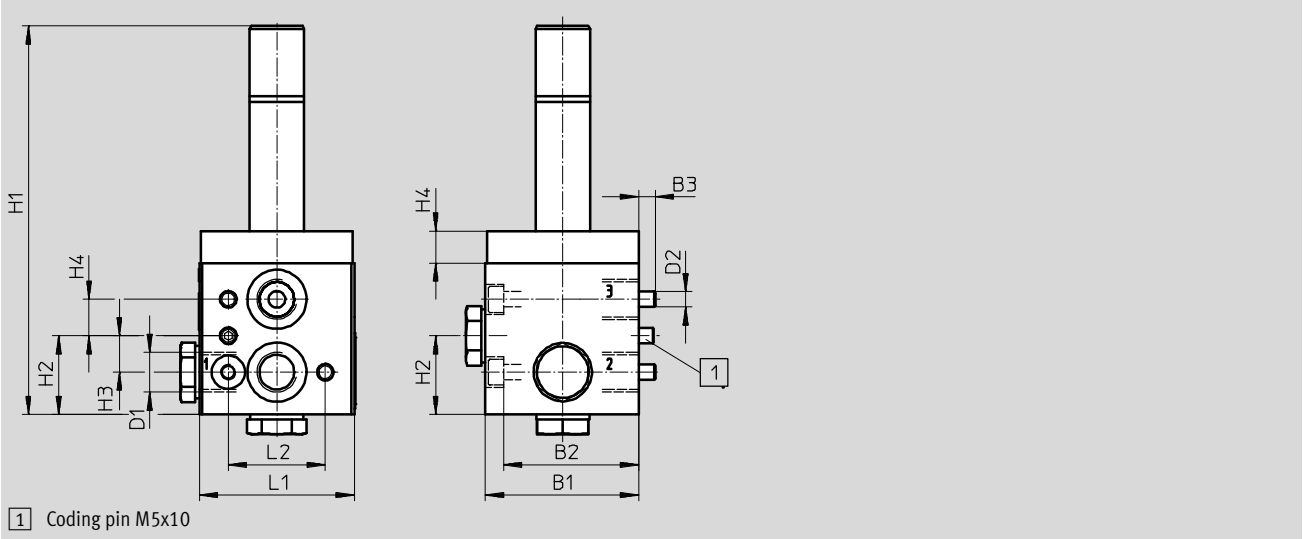

Type	B1	B2	B3	D1	D2	H1	H2	H3	H4	L1	L2
VOFD-LT-M32-MN-FGP14-F10	50.5	44.5	5.5	G $\frac{1}{4}$, NAMUR	M5	128.2	26	10.5	12	51	32

Basic valves VOFD

Technical data – 3/2-way valves, G $\frac{1}{4}$ and NPT $\frac{1}{4}$ -18

FESTO

Function
3/2-way valve

 Flow rate
450 l/min

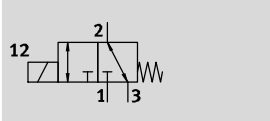

General technical data		G $\frac{1}{4}$ basic valve	NPT $\frac{1}{4}$ -18
Valve function		3/2-way, closed, single solenoid	
Pneumatic connection	1	G $\frac{1}{4}$	NPT $\frac{1}{4}$ -18
	2	G $\frac{1}{4}$	NPT $\frac{1}{4}$ -18
	3	G $\frac{1}{4}$	NPT $\frac{1}{4}$ -18
Design		Directly actuated poppet valve	
Width	[mm]	51	
Mounting position		Any	
Duty cycle		100%	
Sealing principle		Soft	
Manual override		None	
Reset method		Mechanical spring	
Actuation type		Electric	
Suitable for vacuum		Yes	
Type of control		Direct	
Flow rate for piston valve pressurisation	[m 3 /h]	0.36	
Flow rate for piston valve exhausting	[m 3 /h]	0.36	
Direction of flow		Reversible	
Product weight	[g]	560	
Response time off	[ms]	9	
Response time on	[ms]	45	
Nominal size	[mm]	5	
Standard nominal flow rate	[l/min]	450	

Operating and environmental conditions		G $\frac{1}{4}$ basic valve	NPT $\frac{1}{4}$ -18
Operating medium		Compressed air in accordance with ISO 8573-1:2010 [–:–:–]	
Protection class		IP65	
Operating pressure range	[bar]	0 ... 10	
Temperature of medium	[°C]	–10 ... 60	
Ambient temperature	[°C]	–10 ... 60	
Extended ambient temperature, Low Demand mode	[°C]	–25 ... 60	
Safety integrity level	[SIL]	Up to SIL 4 Low Demand mode	
		Up to SIL 4 High Demand mode	
Corrosion resistance class CRC ¹⁾		4	

1) Corrosion resistance class 4 according to Festo standard 940 070
Components subject to particularly high corrosion stress. Parts used with aggressive media, e.g. in the food or chemical industry. These applications should be supported with special tests with the media if required.

Basic valves VOFD

Technical data – 3/2-way valves, G1/4 and NPT1/4-18

Materials

Sectional view

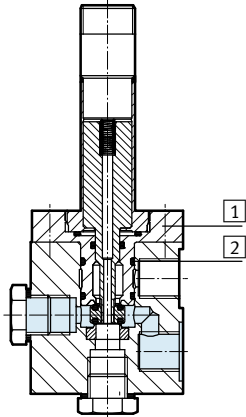

Solenoid valves	G1/4 basic valve	NPT1/4-18
1 Housing	Hard Ematal-anodised aluminium	
2 Seals	Nitrile rubber	
- Note on materials	Contains PWIS (paint-wetting impairment substances), RoHS-compliant	

Dimensions

Download CAD data → www.festo.com

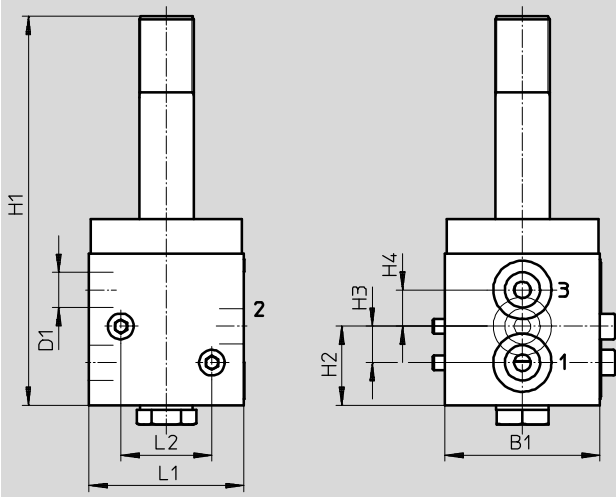

Type	B1	D1	H1	H2	H3	H4	L1	L2
VOFD-LT-M32-MN-G14-F10	51	G1/4	128.2	26	12	12	51	30
VOFD-LT-M32-MN-N14-F10	51	NPT1/4	128.2	26	12	12	51	30

Basic valves VOFD

Technical data – 3/2-way valves, G $\frac{1}{4}$ and NPT $\frac{1}{4}$ -18

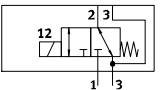
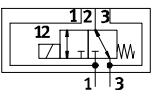
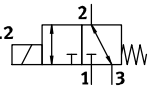
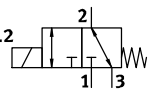
Ordering data				
Circuit symbol	Function	Pneumatic connection	Part No.	Type
Directly actuated poppet valve				
	3/2-way, closed, single solenoid	G $\frac{1}{4}$ and NAMUR	562 883	VOFD-LT-M32-MN-FG14-F10
	3/2-way, closed, single solenoid	NAMUR with P connection	570 786	VOFD-LT-M32-MN-FGP14-F10
	3/2-way, closed, single solenoid	G $\frac{1}{4}$	562 881	VOFD-LT-M32-MN-G14-F10
	3/2-way, closed, single solenoid	NPT $\frac{1}{4}$ -18	562 882	VOFD-LT-M32-MN-N14-F10

Solenoid valves VOFD

Technical data – 3/2-way valves, G $\frac{1}{4}$

FESTO

Function
3/2-way valve

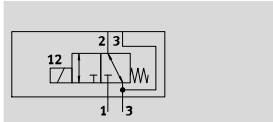
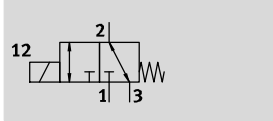

-  - Flow rate
450 l/min

-  - Voltage
24 V DC/AC



General technical data		G $\frac{1}{4}$ solenoid valve	NPT $\frac{1}{4}$ solenoid valve	G $\frac{1}{4}$ solenoid valve and NAMUR
Valve function		3/2-way, closed, single solenoid		
Pneumatic connection	1	G $\frac{1}{4}$	NPT $\frac{1}{4}$ -18	G $\frac{1}{4}$
	2	G $\frac{1}{4}$	NPT $\frac{1}{4}$ -18	G $\frac{1}{4}$ and NAMUR port pattern
	3	G $\frac{1}{4}$	NPT $\frac{1}{4}$ -18	G $\frac{1}{4}$
	4	-	-	G $\frac{1}{4}$ and NAMUR port pattern
Design		Directly actuated poppet valve		
Width	[mm]	51		
Mounting position		Any		
Duty cycle		100%		
Sealing principle		Soft		
Manual override		None		
Reset method		Mechanical spring		
Actuation type		Electric		
Electrical connection		Terminal box, cable entry thread M20x1.5		
Permissible voltage fluctuations		-15%/+10%		
Coil characteristics	DC voltage 24 V	[W]	3.5	
	AC voltage 24 V	[VA]	3.5	
Suitable for vacuum		Yes		
Type of control		Direct		
Flow rate for piston valve pressurisation		[m 3 /h]	0.36	
Flow rate for piston valve exhausting		[m 3 /h]	0.36	
Direction of flow		Non-reversible		G $\frac{1}{4}$ + NPT: reversible, G $\frac{1}{4}$ + Namur: non-reversible
Product weight	[g]	1,140		
Response time off	[ms]	9		
Response time on	[ms]	45		
Nominal size	[mm]	5		
Standard nominal flow rate	[l/min]	450		

Solenoid valves VOFD

Technical data – 3/2-way valves, G $\frac{1}{4}$

FESTO

Operating and environmental conditions		G $\frac{1}{4}$ solenoid valve	NPT $\frac{1}{4}$ solenoid valve	G $\frac{1}{4}$ solenoid valve and NAMUR
Operating medium		Compressed air in accordance with ISO 8573-1:2010 [–:–:–]		
Protection class		IP65		
Operating pressure range	[bar]	0 ... 10		
Temperature of medium	[°C]	–10 ... 60		
Ambient temperature	[°C]	–10 ... 60		
Extended ambient temperature, Low Demand mode	[°C]	–25 ... 60		
ATEX category for gas		II 2G		
ATEX category for dust		II 2D		
Explosion ignition protection type for gas		Ex emb II T6, T5		
Explosion ignition protection type for dust		Ex tD A21 IP65 T80°C, T95°C		
Explosion-proof temperature rating	T80°C	–20°C ≤ Ta ≤ +50°C		
	T95°C	–20°C ≤ Ta ≤ +60°C		
Certificate issuing authority		PTB 08 ATEX 2033 X		
CE mark (see declaration of conformity)		To EU Explosion Protection Directive (ATEX)		
Safety integrity level	[SIL]	Up to SIL 4 Low Demand mode		
		Up to SIL 4 High Demand mode		
Corrosion resistance class CRC ¹⁾		4		

1) Corrosion resistance class 4 according to Festo standard 940 070

Components subject to particularly high corrosion stress. Parts used with aggressive media, e.g. in the food or chemical industry. These applications should be supported with special tests with the media if required.

Materials

Sectional view

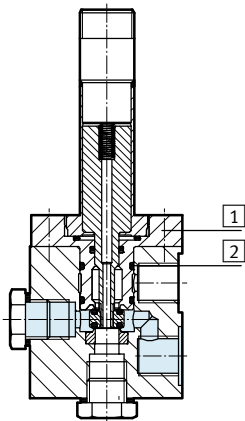

Solenoid valves		G $\frac{1}{4}$ solenoid valve	NPT $\frac{1}{4}$ solenoid valve	G $\frac{1}{4}$ solenoid valve and NAMUR
1	Housing	Hard Ematal-anodised aluminium		
2	Seals	Nitrile rubber		
–	Note on materials	Contains PWIS (paint-wetting impairment substances), RoHS-compliant		

Solenoid valves VOFD

Technical data – 3/2-way valves, G $\frac{1}{4}$

Dimensions

Download CAD data → www.festo.com

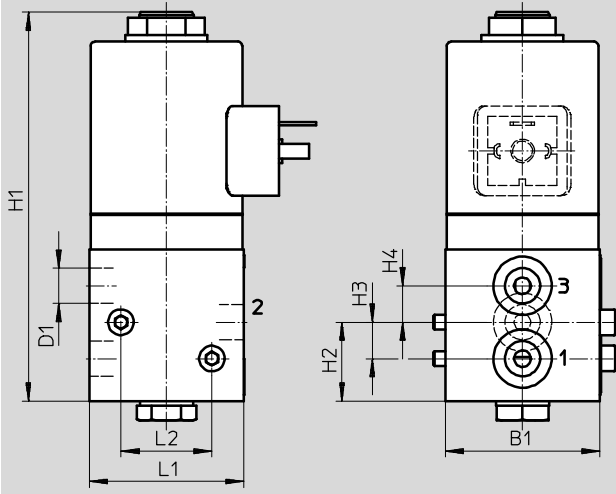

Type	B1	B2	D1	H1	H2	H3	H4	H5	H6	L1	L2
VOFD-LT-M32-MN-G14-1UK4-Ex4me	51	30	G $\frac{1}{4}$	159.8	38	26	14	14	12	51	67
VOFD-LT-M32-MN-N14-1UK4-Ex4me	51	30	NPT $\frac{1}{4}$	159.8	38	26	14	14	12	51	67

Dimensions

Download CAD data → www.festo.com

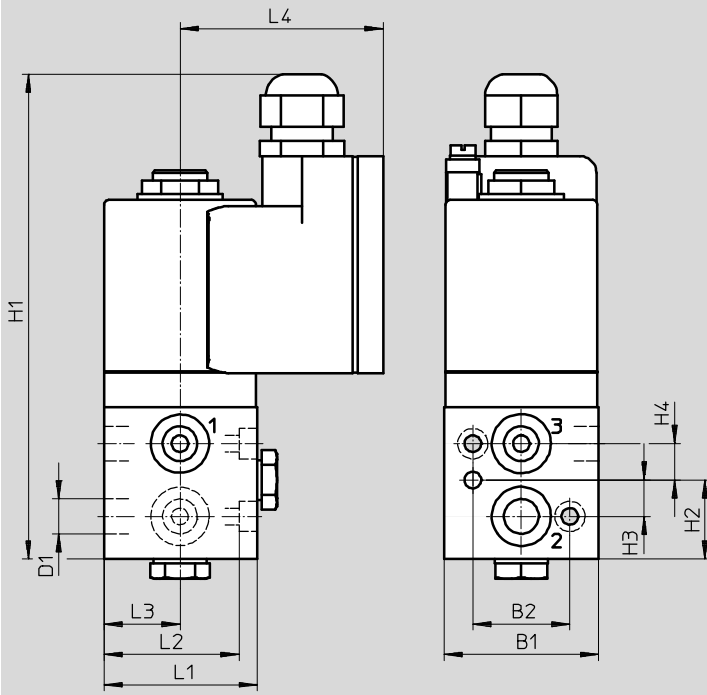

Type	B1	B2	D1	H1	H2	H3	H4	L1	L2	L3	L4
VOFD-LT-M32-MN-FG14-1UK4-Ex4me	51	32	NAMUR G $\frac{1}{4}$	159.8	26	12	12	50.5	44.5	25	67

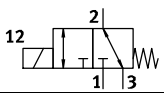
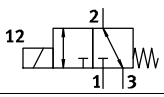
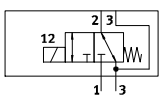

Solenoid valves VOFD

Technical data – 3/2-way valves, G $\frac{1}{4}$

Ordering data					
Circuit symbol	Function	Pneumatic connection	Ex ignition protection type	Part No.	Type
Directly actuated poppet valve					
	3/2-way, closed, single solenoid	G $\frac{1}{4}$	Ex emb II T6, T5	562 884	VOFD-LT-M32-MN-G14-1UK4-Ex4me
	3/2-way, closed, single solenoid	NPT $\frac{1}{4}$	Ex emb II T6, T5	562 885	VOFD-LT-M32-MN-N14-1UK4-Ex4me
	3/2-way, closed, single solenoid	G $\frac{1}{4}$ and NAMUR	Ex emb II T6, T5	562 886	VOFD-LT-M32-MN-FG14-1UK4-Ex4me

Solenoid coils VACC-S18

Technical data

-  Voltage
24 V DC/AC
-  Temperature range
-20 ... +60 °C



General technical data				
Type	VACC-S18-K4-1U-Ex4me [24 V DC/AC]	VACC-S18-K4-2U-Ex4me [110 V DC/AC]	VACC-S18-K4-3U-Ex4me [230 V DC/AC]	VACC-S18-K4-1UF-Ex4me [24 V DC/AC]
Actuation type	Electric			
Mounting position	Any			
Duty cycle	[%]	100		
Electrical connection	Terminal box, cable entry thread M20x1.5			
Internal fuse protection	-			Fuse
Manual override	None			
Switching position display	No			
Product weight	[g]	580		
Note on materials	Contains PWIS (paint-wetting impairment substances), RoHS-compliant			
Information on solenoid coil materials	Polyamide, steel			
Coil characteristics	DC voltage 24 V	[W]	3.5	
	AC voltage 24 V	[VA]	3	

Operating and environmental conditions		
Protection class	IP65	
Permissible voltage fluctuations	-15 %/+10 %	
Ambient temperature	[°C]	-20 ... 60
ATEX category for gas	II 2G	
ATEX category for dust	II 2D	
Explosion ignition protection type for gas	Ex emb II T6, T5	
Explosion ignition protection type for dust	Ex tD A21 IP65 T80°C, T95°C	
Explosion-proof temperature rating	T80°C	-20°C ≤ Ta ≤ +50°C
	T95°C	-20°C ≤ Ta ≤ +60°C
Certificate issuing authority	PTB 08 ATEX 2033 X	
CE mark (see declaration of conformity)	To EU Explosion Protection Directive (ATEX)	
Corrosion resistance class CRC ¹⁾	4	

1) Corrosion resistance class 4 according to Festo standard 940 070
Components subject to particularly high corrosion stress. Parts used with aggressive media, e.g. in the food or chemical industry. These applications should be supported with special tests with the media if required.

Materials	
Solenoid coils	
Housing	Steel, polyamide
Note on materials	RoHS-compliant, contains PWIS (paint-wetting impairment substances)

Solenoid coils VACC-S18

Technical data

FESTO

Dimensions

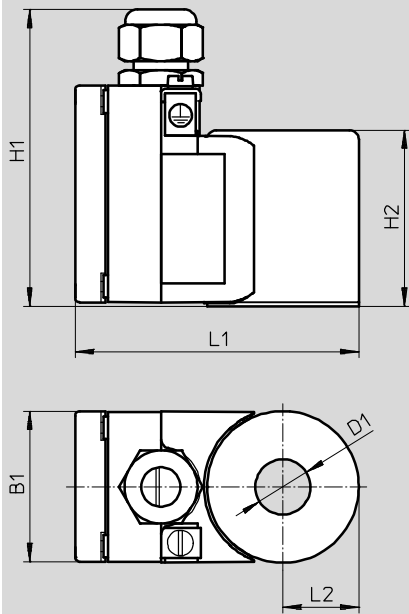

Download CAD data → www.festo.com



Type	B1	D1 ∅	H1	H2	L1	L2
VACC-S18-K4-1U-Ex4me	50	18.2	100	58	95	25
VACC-S18-K4-2U-Ex4me	50	18.2	100	58	95	25
VACC-S18-K4-3U-Ex4me	50	18.2	100	58	95	25
VACC-S18-K4-1UF-Ex4me	50	18.2	100	58	95	25

Solenoid coils VACC-S18

Technical data

-  Voltage
24 V DC/AC
-  Temperature range
-20 ... +60 °C



General technical data				
Type		VACC-S18-K5-1U-Ex3D [24 V DC/AC]	VACC-S18-K5-2U-Ex3D [110 V DC/AC]	VACC-S18-K5-3U-Ex3D [230 V DC/AC]
Actuation type		Electric		
Mounting position		Any		
Duty cycle	[%]	100		
Electrical connection		Terminal box, cable entry thread NPT 1/2		
Manual override		None		
Switching position display		No		
Product weight	[g]	1,700		
Coil characteristics	DC voltage 24 V	[W]	2.5	
	AC voltage 24 V	[VA]	3.5	

Operating and environmental conditions	
Protection class	IP65
Permissible voltage fluctuations	-15 %/+10 %
Ambient temperature	[°C] -20 ... 60
Operating pressure range	[bar] 0 ... 10
ATEX category for gas	II 2G
Explosion ignition protection type for gas	Ex d IIC T6, T5, T4
Explosion protection certification outside the EU	EPL Gb (BR), EPL Gb (CN), EPL Gb (RU), EPL Gc (BR), EPL Gc (CN), EPL Gc (RU)
CE mark (see declaration of conformity)	To EU Explosion Protection Directive (ATEX)
Corrosion resistance class CRC ¹⁾	4

1) Corrosion resistance class 4 according to Festo standard 940 070
Components subject to particularly high corrosion stress. Parts used with aggressive media, e.g. in the food or chemical industry. These applications should be supported with special tests with the media if required.

Materials	
Solenoid coils	
Housing	Grey cast iron, wrought aluminium alloy
Note on materials	Contains PWIS (paint-wetting impairment substances), conforms to RoHS

Solenoid coils VACC-S18

FESTO

Technical data

-  Voltage
24 V DC/AC

-  Temperature range
-20 ... +60 °C



General technical data			
Type	VACC-S18-K4-1U-Ex3D [24 V DC/AC]	VACC-S18-K4-2U-Ex3D [110 V DC/AC]	VACC-S18-K4-3U-Ex3D [230 V DC/AC]
Actuation type	Electric		
Mounting position	Any		
Duty cycle	[%]	100	
Electrical connection	Terminal box, cable entry thread M20x1.5		
Manual override	None		
Switching position display	No		
Product weight	[g]	1,700	
Coil characteristics	DC voltage 24 V	[W]	2.5
	AC voltage 24 V	[VA]	3.5

Operating and environmental conditions	
Protection class	IP65
Permissible voltage fluctuations	-15 %/+10 %
Ambient temperature	[°C] -20 ... 60
Operating pressure range	[bar] 0 ... 10
ATEX category for gas	II 2G
Explosion ignition protection type for gas	Ex d IIC T6, T5, T4
Explosion protection certification outside the EU	EPL Gb (BR), EPL Gb (CN), EPL Gb (RU), EPL Gc (BR), EPL Gc (CN), EPL Gc (RU)
CE mark (see declaration of conformity)	To EU Explosion Protection Directive (ATEX)
Corrosion resistance class CRC ¹⁾	4

1) Corrosion resistance class 4 according to Festo standard 940 070
Components subject to particularly high corrosion stress. Parts used with aggressive media, e.g. in the food or chemical industry. These applications should be supported with special tests with the media if required.

Materials	
Solenoid coils	
Housing	Grey cast iron, wrought aluminium alloy
Note on materials	Contains PWIS (paint-wetting impairment substances), conforms to RoHS

Solenoid coils VACC-S18

Technical data

Dimensions

Download CAD data → www.festo.com

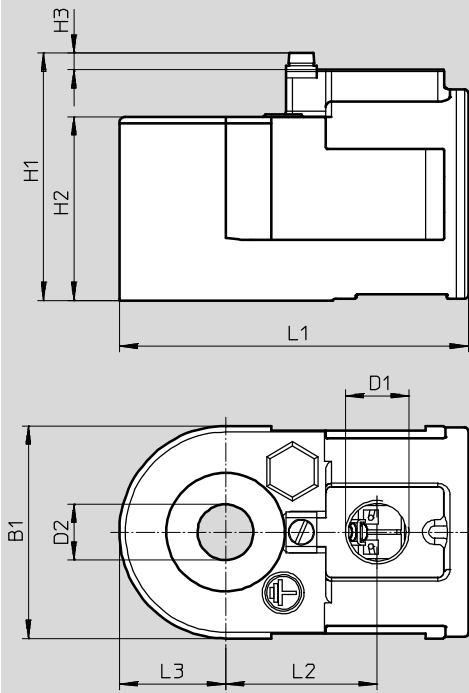

Type	B1	D1	D2 Ø	H1	H2	H3	L1	L2	L3
VACC-S18-K4-1U-Ex3D	70	M20x1.5	18.2	82	60.5	6	115	50	35
VACC-S18-K4-2U-Ex3D	70	M20x1.5	18.2	82	60.5	6	115	50	35
VACC-S18-K4-3U-Ex3D	70	M20x1.5	18.2	82	60.5	6	115	50	35

Type	B1	D1	D2 Ø	H1	H2	H3	L1	L2	L3
VACC-S18-K5-1U-Ex3D	70	NPT 1/2	18.2	82	60.5	6	115	50	35
VACC-S18-K5-2U-Ex3D	70	NPT 1/2	18.2	82	60.5	6	115	50	35
VACC-S18-K5-3U-Ex3D	70	NPT 1/2	18.2	82	60.5	6	115	50	35

Solenoid coils VACC-S18

Technical data

-  Voltage
24 V DC/AC

-  Temperature range
-20 ... +60 °C



General technical data					
Type	VACC-S18-A1-1 [24 V DC]		VACC-S18-A1-1A [24 V AC]	VACC-S18-A1-2A [110 V AC]	VACC-S18-A1-3A [230 V AC]
Actuation type	Electric				
Mounting position	Any				
Duty cycle	[%]	100			
Electrical connection	Plug design to EN 175301-803, type A				
Manual override	None				
Switching position display	No				
Product weight	[g]	530			580
Coil characteristics	DC voltage 24 V	[W]	3.5	-	-
	AC voltage 24 V	[VA]	-	5	-

Operating and environmental conditions					
Type	VACC-S18-A1-1 [24 V DC]		VACC-S18-A1-1A [24 V AC]	VACC-S18-A1-2A [110 V AC]	VACC-S18-A1-3A [230 V AC]
Protection class	IP65				
CE mark (see declaration of conformity)	-			To EU Low Voltage Directive	
Permissible voltage fluctuations	-15 %/+10 %				
Ambient temperature	[°C]	-20 ... 60			
Operating pressure range	[bar]	0 ... 10			
Corrosion resistance class CRC ¹⁾	4				

1) Corrosion resistance class 4 according to Festo standard 940 070
Components subject to particularly high corrosion stress. Parts used with aggressive media, e.g. in the food or chemical industry. These applications should be supported with special tests with the media if required.

Materials	
Housing	Steel, polyamide
Note on materials	RoHS-compliant, contains PWIS (paint-wetting impairment substances)

Solenoid coils VACC-S18

Technical data

FESTO

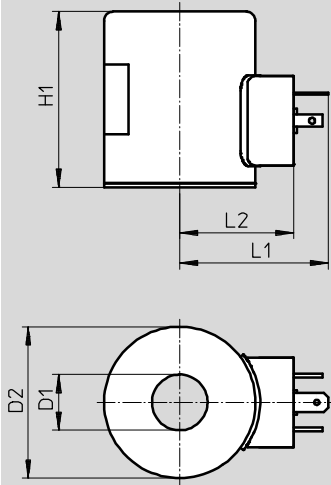

Dimensions

Download CAD data → www.festo.com



Type	D1 Ø	D2 Ø	H1	L1	L2
VACC-S18-A1-1	18.2	50	58	50	38
VACC-S18-A1-1A	18.2	50	58	50	38
VACC-S18-A1-2A	18.2	50	58	50	38
VACC-S18-A1-3A	18.2	50	58	50	38

Ordering data

		Part No.	Type
Ex-me coil			
		562 897	VACC-S18-K4-1U-Ex4me
		570 785	VACC-S18-K4-1UF-Ex4me
		562 898	VACC-S18-K4-2U-Ex4me
		562 899	VACC-S18-K4-3U-Ex4me
Ex-3D coil			
		562 900	VACC-S18-K5-1U-Ex3D
		562 901	VACC-S18-K5-2U-Ex3D
		562 902	VACC-S18-K5-3U-Ex3D
		562 903	VACC-S18-K4-1U-Ex3D
		562 904	VACC-S18-K4-2U-Ex3D
		562 905	VACC-S18-K4-3U-Ex3D
A1 coil			
		562 906	VACC-S18-A1-1
		562 907	VACC-S18-A1-1A
		562 908	VACC-S18-A1-2A
		562 909	VACC-S18-A1-3A

Solenoid valves

Accessories



Flow control plate

Material: Manifold rail:

Wrought aluminium alloy

Contains PWIS (paint-wetting impairment substances), RoHS-compliant

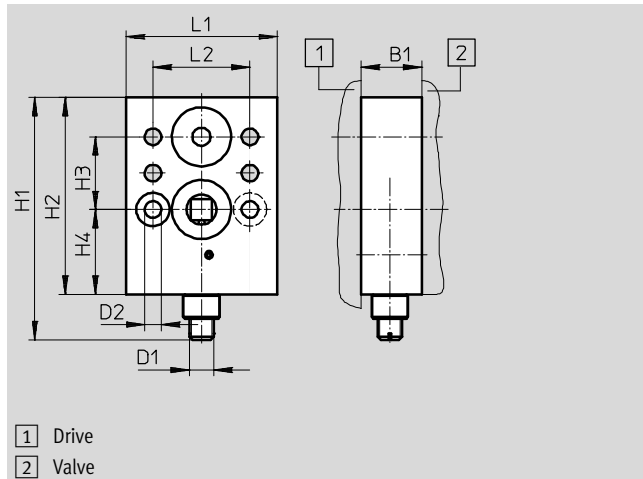

Dimensions [mm] and ordering data												
B1	D1	D2	H1	H2	H3	H4	L1	L2	L3	CRC ¹⁾	Part No.	Type
15	G ¹ / ₄	5.5	73	56	12	32	50	24	13	3	563 401	VABF-S7-F1B5P1-F

1) Corrosion resistance class 3 according to Festo standard 940 070
Components subject to high corrosion stress. External visible parts in direct contact with industrial atmospheres or media such as solvents and cleaning agents, with a predominantly functional requirement for the surface.

Mounting plate

Material: Wrought aluminium alloy

Contains PWIS (paint-wetting impairment substances), RoHS-compliant

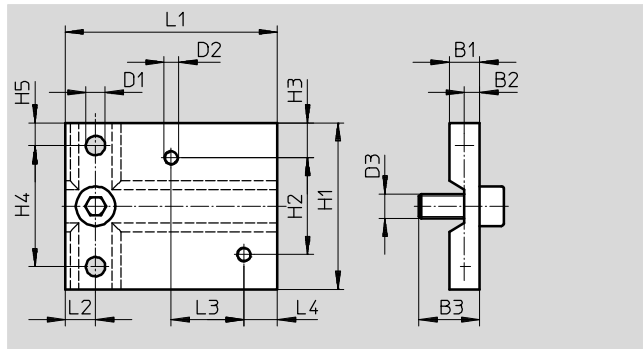

Dimensions [mm] and ordering data																	
B1	B2	B3	D1	D2	D3	H1	H2	H3	H4	H5	L1	L2	L3	L4	CRC ¹⁾	Part No.	Type
10	5	20	6.4	M5	M8	55	32	11.5	40	7.5	70	10	24	11	3	563 399	VAME-S7-P

1) Corrosion resistance class 3 according to Festo standard 940 070
Components subject to high corrosion stress. External visible parts in direct contact with industrial atmospheres or media such as solvents and cleaning agents, with a predominantly functional requirement for the surface.

Solenoid valves

Accessories

Connection plate kit

Material:

Wrought aluminium alloy

Contains PWIS (paint-wetting impairment substances), RoHS-compliant

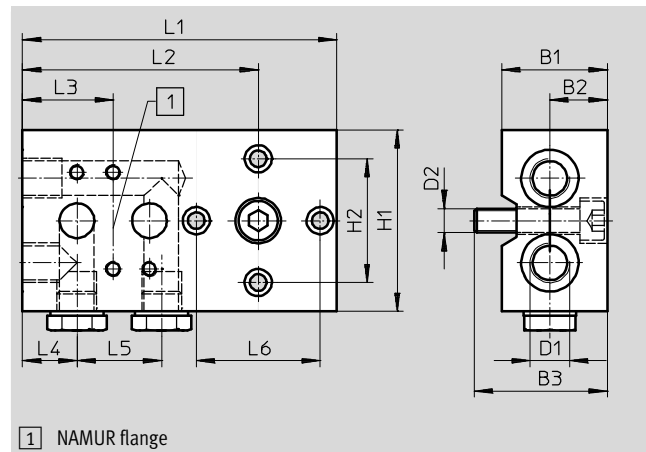

Dimensions [mm] and ordering data														Part No.	Type
B1	B2	B3	D1	D2	H1	H2	L1	L2	L3	L4	L5	L6	CRC ¹⁾		
35	19	44	G ¹ / ₄	M8	60	41	104	70	30	18	28	41	3	563 396	VABF-S7-S-G14

1) Corrosion resistance class 3 according to Festo standard 940 070
 Components subject to high corrosion stress. External visible parts in direct contact with industrial atmospheres or media such as solvents and cleaning agents, with a predominantly functional requirement for the surface.

Mounting bracket

Material: Wrought aluminium alloy

Contains PWIS (paint-wetting impairment substances), RoHS-compliant

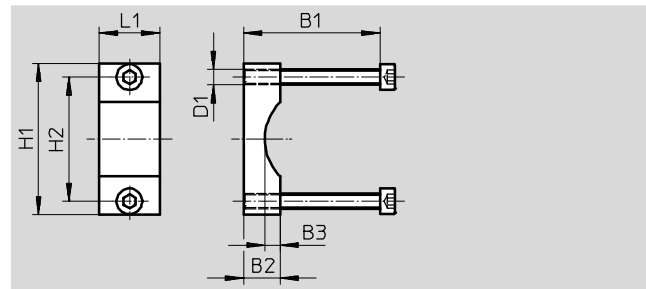

Dimensions [mm] and ordering data								Part No.	Type
B1	B2	B3	D1	H1	H2	L1	CRC ¹⁾		
45/65	12	5	M5	50	41	20	3	563 403	VAME-S7-Y

1) Corrosion resistance class 3 according to Festo standard 940 070
 Components subject to high corrosion stress. External visible parts in direct contact with industrial atmospheres or media such as solvents and cleaning agents, with a predominantly functional requirement for the surface.

Solenoid valves

Accessories



Adapter with filter

Note on materials:
Contains PWIS (paint-wetting impairment substances), RoHS-compliant

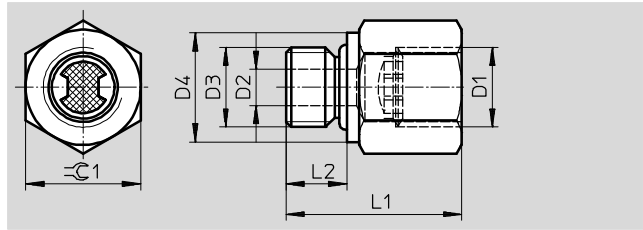

Dimensions [mm] and ordering data									
D1	D2	D3	D4	L1	L2	C1	CRC ¹⁾	Part No.	Type
NPT ^{1/4}	6	G ^{1/4}	18	29	10	19	1	563 397	NPFV-AF-G14-N14-MF
G ^{1/4}	6	G ^{1/4}	18	29	10	19	1	563 398	NPFV-AF-G14-G14-MF

1) Corrosion resistance class 1 according to Festo standard 940 070
Components subject to low corrosion stress. Transport and storage protection. Parts that do not have primarily decorative surface requirements, e.g. in internal areas that are not visible or behind covers.

Exhaust protection

Material:
Ethylene propylene rubber
Contains PWIS (paint-wetting impairment substances), RoHS-compliant

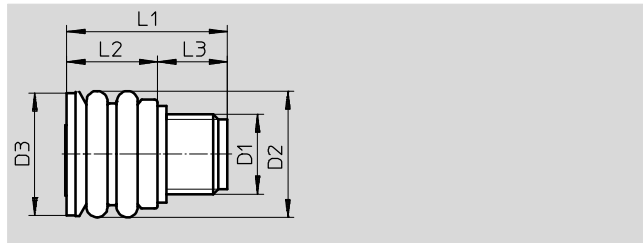

Dimensions [mm] and ordering data								
D1	D2	D3	L1	L2	L3	CRC ¹⁾	Part No.	Type
G ^{1/4}	21	20.5	26.5	15	11.5	3	563 400	VABD-D3-SN-G14

1) Corrosion resistance class 3 according to Festo standard 940 070
Components subject to high corrosion stress. External visible parts in direct contact with industrial atmospheres or media such as solvents and cleaning agents, with a predominantly functional requirement for the surface.

Solenoid valves

Accessories

Hand lever

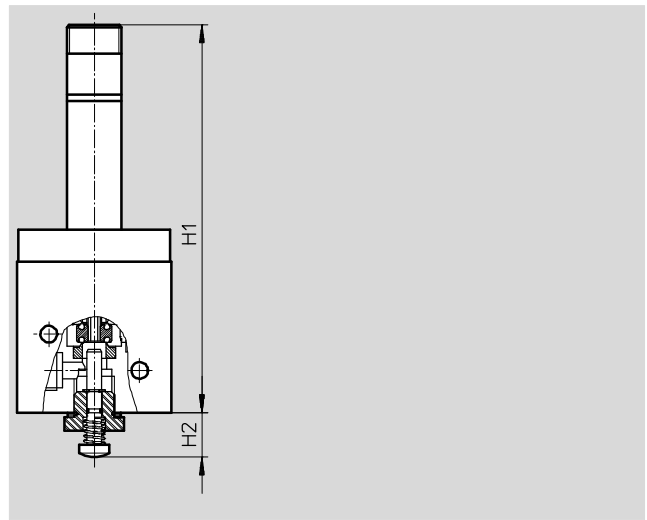

Material:

Contains PWIS (paint-wetting impairment substances), RoHS-compliant



Dimensions [mm] and ordering data			
H1	H2	CRC ¹⁾	Part No. Type
128	14	3	563 402 VA0H-S8

1) Corrosion resistance class 3 according to Festo standard 940 070
 Components subject to high corrosion stress. External visible parts in direct contact with industrial atmospheres or media such as solvents and cleaning agents, with a predominantly functional requirement for the surface.

Ordering data		Part No.	Type
Cable		Technical data → Internet: kmc	
		30 931	KMC-1-24 DC-2,5-LED
		30 932	KMC-1-230 AC-2,5
		30 933	KMC-1-24 DC-5-LED
		30 934	KMC-1-230 AC-5
		30 935	KMC-1-24-10-LED
Plug socket with screw terminal technology		Technical data → Internet: mssd	
		34 583	MSSD-C