

# Control block VOFA with safety function



# Control block VOFA with safety function

Key features

FESTO

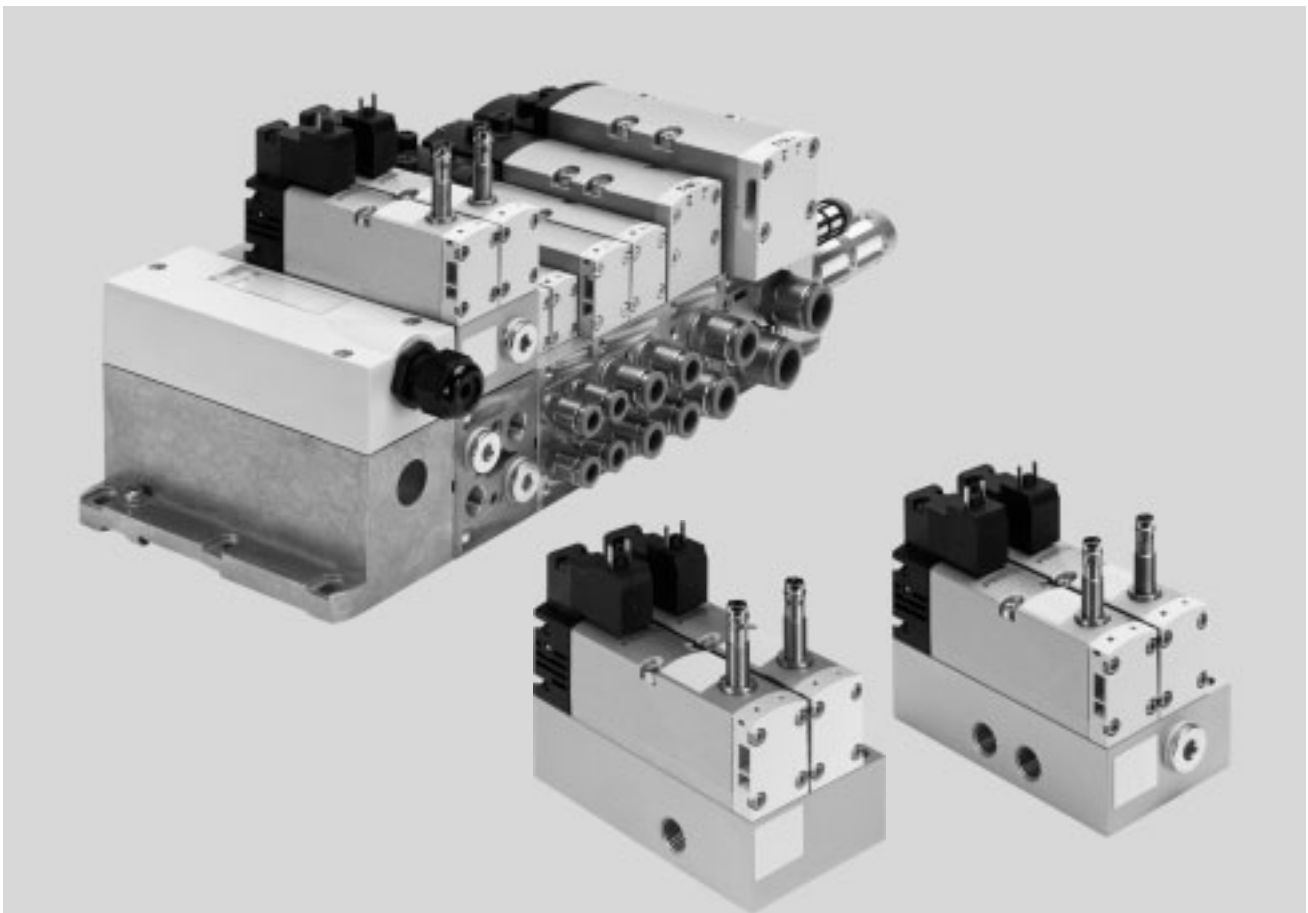

## Innovative

- Can be used for safe reversing of a hazardous movement (5/2-way solenoid valve)
- Can be used for safe venting (3/2-way solenoid valve function, not available as a variant for installation on a valve terminal)
- Purely mechanical solution as a press safety valve, without integrated diagnostics

## Versatile

- Control block can be selected as version for valve terminal VTSA/VTSA-F
- Control block can be selected as individual pneumatic connection
- High pressure range of 3 ... 10 bar
- Flow rates of up to 1,050 l/min

## Reliable

- Sturdy and durable metal components
- Designed as a purely mechanical solution with regard to safety

## Easy to assemble

- Unit assembled and inspected, ready for installation
- Reduced outlay on selection, ordering, installation and commissioning
- Mounting via through-hole (with individual pneumatic connection)
- Mounting as vertical stacking elements on manifold sub-base of the valve terminal

### - Note

The control block with safety function VOFA must not be modified by the customer without authorisation as this invalidates the IFA approval

certificate.  
The IFA certificate is linked to the checked safety function of the component.

# Control block VOFA with safety function

Key features

Description			
<p>The control block is designed for two-channel actuation of pneumatic drive components such as double-acting cylinders, and can be used to realise the following safety measures:</p> <ul style="list-style-type: none"> <li>• Protection against unexpected start-up (EN 1037)</li> <li>• Reversing hazardous movements, provided the reversing movement will not lead to any further hazards (5/2-way valve, single solenoid)</li> <li>• Safe venting (with 3/2-way valve function in normally closed position)</li> </ul>	<p>The control attributes of the control block enable Performance Level e (up to Category 4, corresponds to the highest risk level) to be achieved for the safety measures. The Performance Level (PL) is a measure of the reliability of a safety function. The control block has been developed and manufactured in accordance with the basic and proven safety principles of EN ISO 13849-1 and EN ISO 13849-2.</p>	<p>The requirements of EN ISO 13849-1 and EN ISO 13849-2 (e.g. CCF, DC) must be taken into consideration for implementation and operation of the component and for use in higher categories (2 to 4). When using this product in machines or systems subject to specific C standards, the requirements specified in these standards must be observed.</p>	<p>The control block with safety function is designed for installation in machines and automation systems and must only be used in industrial applications (high-demand mode). The control block with safety function is suitable for use as a press safety valve to EN 962.</p> <p>Further information and technical data in the Support Portal ➔ Internet: safety-related guidelines</p>

Pneumatic/electrical interlinking			
Function			
<p>The safety function is achieved through two-channel pneumatic interlinking of two 5/2-way single solenoid valves, width 26 mm, within the control block:</p> <ul style="list-style-type: none"> <li>• Port 4 is only pressurised if both solenoid valves are in switching position.</li> <li>• Port 2 is always pressurised if at least one of the two solenoid valves</li> </ul>	<p>is in normal position. The valve is reset via a mechanical spring.</p> <p>The switching operation of the solenoid valves can be sensed by a proximity sensor on the solenoid valves (switching position sensing). This is done by comparing a logic operation of the control signal and the signal change of the proximity sensor</p>	<p>to check whether the piston spools of the solenoid valves achieve the expected position.</p> <p>The piston spools of the solenoid valves are designed so that pneumatic short circuits between ports 2 and 4 are ruled out (freedom from overlap).</p>	<p>The two solenoid valves must be actuated via two separate channels to achieve the desired Category 4 (Performance Level e, to EN ISO 13849-1).</p> <p>The valves used are always 5/2-way solenoid valves with switching position sensing.</p>

# Control block VOFA with safety function

Key features

## Version

Decentralised individual connection variant, VOFA-L26-T52-...

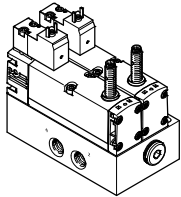

With the decentralised individual connection variant, the electrical connection for the control block is established as an individual connection to ISO 15407-1. The pneumatic connection is also established as an individual connection. With this variant, the two 5/2-way solenoid valves are pneumatically interlinked via two channels by means of the individual sub-base.

The electrical connection for the solenoid valves is established separately via a standardised square plug to EN 175301-803, type C.

The inductive sensor for switching position sensing is electrically connected using a push-in connector M8x1 to EN 61076-2-104.

Decentralised individual connection variant, VOFA-L26-T32C-...

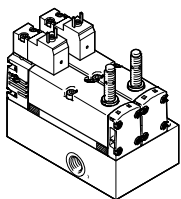

The function as a 3/2-way solenoid valve, normally closed, is intended for use for safe venting.

 Note

The 3/2-way solenoid valve function is only available as a decentralised

individual connection variant (VOFA-L26-...).

Version for valve terminal VTSA/VTSA-F, VOFA-B26-T52-...

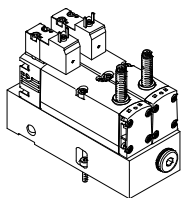

With the version of the control block for valve terminal VTSA/VTSA-F, the valves are actuated separately from the valve terminal via an individual electrical connection.

The pneumatic connection is established via the valve terminal VTSA/VTSA-F.

With the variant for valve terminals, the two 5/2-way solenoid valves are pneumatically interlinked via two channels by means of an intermediate plate as vertical stacking element.

The electrical connection for the solenoid valves is established separately via a standardised square plug to EN 175301-803, type C. The inductive sensor for switching position sensing is electrically connected using a push-in connector M8x1 to EN 61076-2-104.

 Note

The appropriate manifold sub-base VABV-S4- ..., which is required for integration into the valve terminal, is not part of the control block. It is

automatically allocated by the configurator on selection of the control block.

# Control block VOFA with safety function

Key features

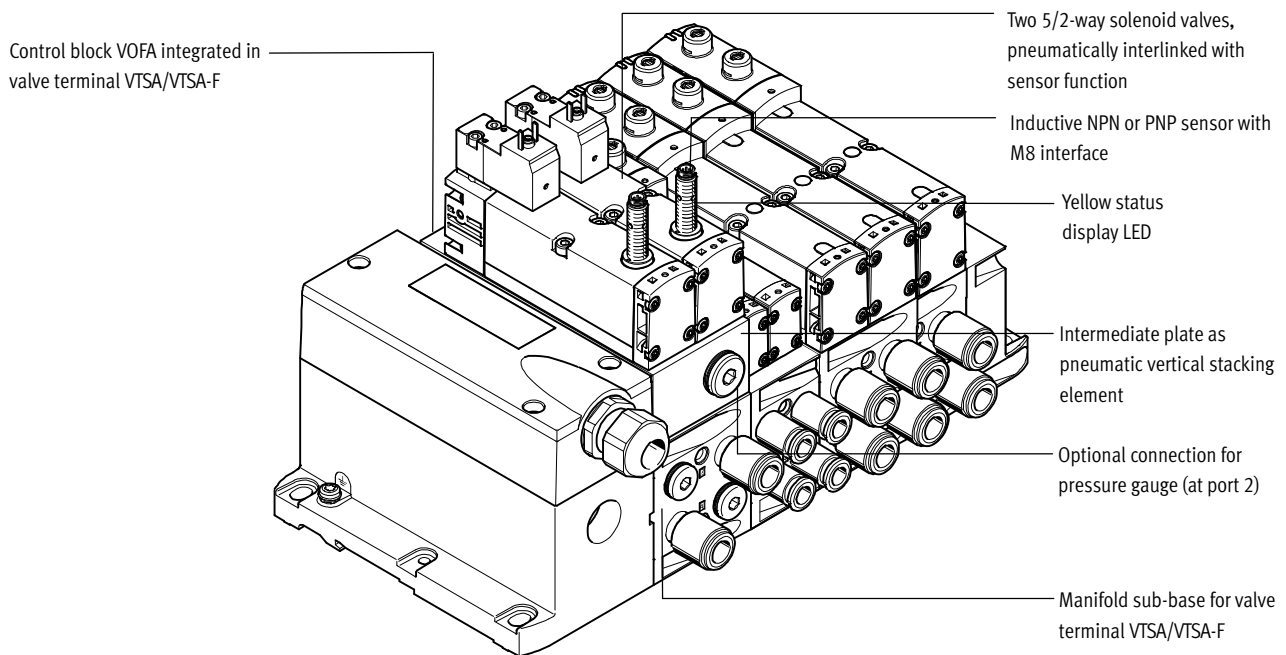

## Equipment options

Control block, version for valve terminal VTSA/VTSA-F, VOFA-B26-T52-...

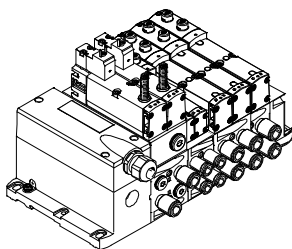

Two 5/2-way solenoid valves, single solenoid, connected in series, interlinked via two channels

- Mechanical spring
- Switching position sensing via inductive sensors with PNP or NPN output

Application:

- Protection against unexpected start-up to EN 1037
- Safe reversing
- Drives in manually loaded devices



Note

The 3/2-way solenoid valve function is not suitable for vertical stacking (on valve terminals).

## Control block as decentralised individual connection variant

VOFA-L26-T52-...

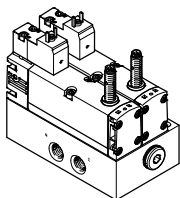

Two 5/2-way valves, single solenoid, connected in series, interlinked via two channels

- Mechanical spring
- Switching position sensing via inductive sensors with PNP or NPN output

Application:

- Protection against unexpected start-up to EN 1037
- Safe reversing (VOFA-L26-T52-...)
- Safe venting (VOFA-L26-T32C-..., 3/2-way solenoid valve function)
- Drives in manually loaded devices



Note

The control block with safety function VOFA must not be modified by the customer without authorisation as this invalidates the IFA approval certificate. The IFA certificate is linked to the checked safety function of the component.

VOFA-L26-T32C-...

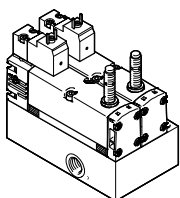

# Control block VOFA with safety function

Key features

**FESTO**

Special features			
Control block for valve terminal VTSA/VTSA-F		Control block as decentralised individual connection variant	
<b>Electrical connection</b> <ul style="list-style-type: none"> <li>• Electrical connection to EN 175301-803, type C (square plug)</li> <li>• 3-pin sensor push-in connector M8</li> </ul>	<b>Pneumatic connection</b> <ul style="list-style-type: none"> <li>• Via valve terminal VTSA/VTSA-F</li> <li>• Pilot air supply via valve terminal</li> <li>• Interlinked via two channels by way of vertical stacking as intermediate plate</li> </ul>	<b>Electrical connection</b> <ul style="list-style-type: none"> <li>• Electrical connection to EN 175301-803, type C (square plug)</li> <li>• 3-pin sensor push-in connector M8</li> </ul>	<b>Pneumatic connection</b> <ul style="list-style-type: none"> <li>• Individual pneumatic connection</li> <li>• Internal pilot air supply</li> <li>• Interlinked via two channels by way of individual sub-base</li> </ul>
Applications			
<p>This control block is suitable for use as a press safety valve to EN 962.</p>	<p>This valve is a safety device in accordance with the Machinery Directive 2006/42/EC.</p>	<p>The 3/2 way solenoid valve version (VOFA-L26-T32C-...) is intended for safe venting.</p>	<p>The version for valve terminal VTSA/VTSA-F and the version as individual connection variant VOFA-L26-T52-... are intended for safe reversing of a hazardous movement.</p>
Valve terminal configurator			→ Internet: <a href="http://www.festo.com">www.festo.com</a>
<p>A valve terminal configurator is available to help you select a suitable valve terminal VTSA/VTSA-F. The control block VOFA for the valve terminal is ordered using this valve terminal configurator. This makes it much easier to order the right product.</p>	<p>The valve terminals are fully assembled according to your order specification and are individually checked. This reduces assembly and installation time to a minimum.</p>	<p>You can order a control block VOFA for the valve terminal VTSA using the order code:</p> <p>Ordering system for VTSA → Internet: <a href="http://vtsa">vtsa</a></p>	<p>You can order a control block VOFA for the valve terminal VTSA-F using the order code:</p> <p>Ordering system for VTSA-F → Internet: <a href="http://vtsa-f">vtsa-f</a></p>

# Control block VOFA with safety function

Key features

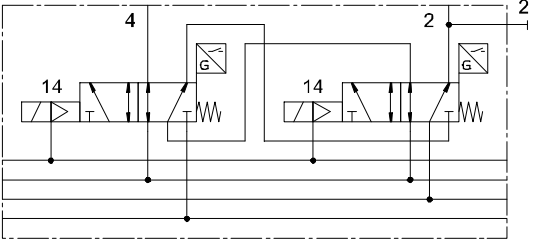
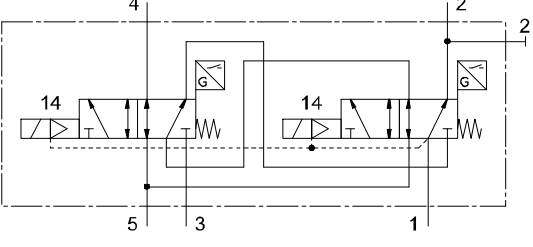
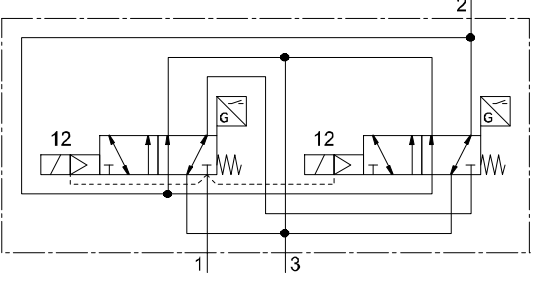
Valve function Circuit symbol <sup>1)</sup>	Description
	<p>Control block VOFA-B26-T52-...</p> <p>As version for valve terminal VTSA/VTSA-F with 2x 5/2-way valve, single solenoid</p> <ul style="list-style-type: none"> <li>• Pneumatic connection via valve terminal</li> <li>• Mechanical spring return</li> <li>• With NPN sensor (code SN) or PNP sensor (code SP)</li> <li>• Fulfils the safety function                             <ul style="list-style-type: none"> <li>– Safe reversing</li> <li>– Protection against unexpected start-up (EN 1037)</li> </ul> </li> </ul>
	<p>Control block VOFA-L26-T52-...</p> <p>As decentralised individual connection variant with 2x 5/2-way valve, single solenoid</p> <ul style="list-style-type: none"> <li>• As individual pneumatic connection</li> <li>• Mechanical spring return</li> <li>• With NPN or PNP sensor</li> <li>• Fulfils the safety function                             <ul style="list-style-type: none"> <li>– Safe reversing</li> <li>– Protection against unexpected start-up (EN 1037)</li> </ul> </li> </ul>
	<p>Control block VOFA-L26-T32C-...</p> <p>As decentralised individual connection variant with 3/2-way solenoid valve function, normally closed (the two valves are pneumatically interlinked by means of the individual sub-base)</p> <ul style="list-style-type: none"> <li>• As individual pneumatic connection</li> <li>• Mechanical spring return</li> <li>• With NPN or PNP sensor</li> <li>• Fulfils the safety function                             <ul style="list-style-type: none"> <li>– Safe venting</li> <li>– Protection against unexpected start-up (EN 1037)</li> </ul> </li> </ul>

1) The symbol represents a valve with a proximity sensor with a switching output signal, in the illustration an N/O contact. In accordance with ISO 1219-1, this symbol applies to both N/O contacts and N/C contacts. The switching element function of all sensors used here is an N/C contact.

 Note

- The 2x 5/2-way solenoid valves each have their own electrical connection.
- The 2x 5/2-way solenoid valves are pneumatically interlinked via two channels by means of an individual sub-base/intermediate plate.
- The output of the interlinked 2x 5/2-way solenoid valves is only switched if both valves are in switching position.

# Control block VOFA with safety function

Technical data

Safety-related characteristics			
Control block	VOFA-L26-T52-...	VOFA-L26-T32C-...	VOFA-B26-T52-... on valve terminal
Conforms to	EN 13849-1		
Safety function	Security against manipulation, protection against unexpected start-up		
	Reversing of a movement	Exhausting	Reversing of a movement
Performance Level (PL)	Security against manipulation, protection against unexpected start-up (up to Category 4, Performance Level e)		
	Reversing of a movement (up to Category 4, Performance Level e)	Exhausting (up to Category 4, Performance Level e)	Reversing of a movement (up to Category 4, Performance Level e)
Reliable component	Yes		
Note on forced checking procedure	Switching frequency at least 1/week		
Certificate issuing authority	IFA 1001179		
CE marking (see declaration of conformity)	To EU Machinery Directive		
	To EU EMC Directive <sup>1)</sup>		
Max. positive test pulse with 0 signal <sup>2)</sup>	[μs]	1,000	
Max. negative test pulse with 1 signal <sup>2)</sup>	[μs]	800	
Shock resistance <sup>2)</sup>	Shock test with severity level 2, to EN 60068-2-27		
Vibration resistance <sup>2)</sup>	Transport application test with severity level 2, to EN 60068-2-6		

- 1) For information about the applicability of the component see the manufacturer's EC declaration of conformity at: [www.festo.com/sp](http://www.festo.com/sp) → User documentation.  
If the component is subject to restrictions on usage in residential, office or commercial environments or small businesses, further measures to reduce the emitted interference may be necessary.
- 2) Please also note the safety-related applications and safety technology on the Support Portal

General technical data			
Control block	VOFA-L26-T52-...	VOFA-L26-T32C-...	VOFA-B26-T52-... on valve terminal
Design	Piston spool valve		
Standard nominal flow rate	[l/min]	950	1,050
Standard flow rate Exhaust from 6 → 0 bar <sup>1)</sup>	[l/min]	–	2,650
Standard flow rate Exhaust 6 → 0 bar in a fault situation <sup>1),2)</sup>	[l/min]	–	1,050
Reset method	Mechanical spring		
Sealing principle	Soft		
Exhaust function	With flow control		
Actuation type	Electric		
Non-overlapping	Yes		
Type of control	Piloted		
Direction of flow	Non-reversible		
Exhaust function	With flow control		
Suitability for vacuum	–		
Pilot air supply	Internal		Via valve terminal
Type of mounting	Via through-hole, on manifold sub-base		
Mounting position	Any		
Manual override	–		
Valve switching status display	Via accessories		
Pneumatic connections			
Supply	1	G $\frac{1}{4}$	G $\frac{1}{4}$
Exhaust	3/5	G $\frac{1}{4}$	G $\frac{1}{4}$ (only 3)
Working lines	2/4	G $\frac{1}{4}$	G $\frac{1}{4}$ (only 2)
Pilot air supply	14	–	–
Pressure gauge		G $\frac{1}{4}$	–
			G $\frac{1}{4}$

- 1) Measured in the exhaust direction (2→3), P= 6 bar measured with respect to atmosphere using a silencer UO-1/4.
- 2) A fault situation means: one of the two directional control valves does not completely switch back.



# Control block VOFA with safety function

Technical data

Operating and environmental conditions			
Control block	VOFA-L26-T52-...	VOFA-L26-T32C-...	VOFA-B26-T52-... on valve terminal
Operating medium	Compressed air to ISO 8573-1:2010 [7:4:4]		
Pilot medium	Compressed air to ISO 8573-1:2010 [7:4:4]		
Note about the operating/pilot medium	Lubricated operation possible (required during subsequent operation)		
Operating pressure [bar]	3 ... 10		0 ... 10
Operating pressure for valve terminal with internal pilot air supply [bar]	-		3 ... 10
Pilot pressure [bar]	3 ... 10		
Noise level LpA [dB(A)]	85		
Ambient temperature [°C]	-5 ... +50		
Temperature of medium [°C]	-5 ... +50		
Corrosion resistance class CRC	0		

Electrical data – Control block			
Control block	VOFA-L26-T52-...	VOFA-L26-T32C-...	VOFA-B26-T52-... on valve terminal
Electrical connection	Plug to EN 175301-803, type C, without protective earth conductor		
Nominal operating voltage [V DC]	24		
Permissible voltage fluctuations [%]	-15/+10		
Surge resistance [kV]	2.5		
Degree of contamination	3		
Power consumption [W]	1.8		
Max. magnetic disruption field [mT]	60		
Piston position sensing	Normal position via sensor		
Switching position display	With accessories		
Duty cycle [%]	100		
Protection class to EN 60529	IP65, NEMA 4 (for all types of signal transmission in assembled state)		
Protection against direct and indirect contact	PELV (Protective Extra-Low Voltage) Protected to EN 60950/IEC 950		
Valve switching time	On [ms]	22	22
	Off [ms]	56	59
Valve sensor switching time <sup>1)</sup>	On [ms]	60	60
	Off [ms]	11	11

1) Valve sensor switching time off: period of time from coil being energised to sensor being switched off when using a PNP sensor.  
Valve sensor switching time on: period of time from coil being de-energised to 0-L edge at the sensor when using a PNP sensor.

 Note  
With a duty cycle of 100%, the control block must be de-energised once a week.

# Control block VOFA with safety function

Technical data

Electrical data – Sensor (to EN-60947-5-2)	
Electrical connection	Cable, 3-wire Plug M8x1, 3-pin
Cable length [m]	2.5
Switching output	PNP or NPN
Switching element function	N/C contact
Switching status display	Yellow LED
Operating voltage range [V DC]	10 ... 30
Residual ripple [%]	±10
Sensor idle current [mA]	Max. 10
Max. output current [mA]	200
Voltage drop [V]	Max. 2
Max. switching frequency [Hz]	5,000
Protection against short circuit	Pulsed
Protection against polarity reversal for sensor	For all electrical connections
Measuring principle	Inductive

Materials	
Sub-base/manifold sub-base	Wrought aluminium alloy
Housing	Die-cast aluminium, PA
Seals	NBR, FPM, HNBR
Screws	Galvanised steel
Sensor housing	High-alloy stainless steel
Sensor cable sheath	PUR
Note on materials	RoHS-compliant

# Control block VOFA with safety function

Technical data

FESTO

## Dimensions

Download CAD data → [www.festo.com](http://www.festo.com)

Decentralised individual connection variant VOFA-L26-T52-...

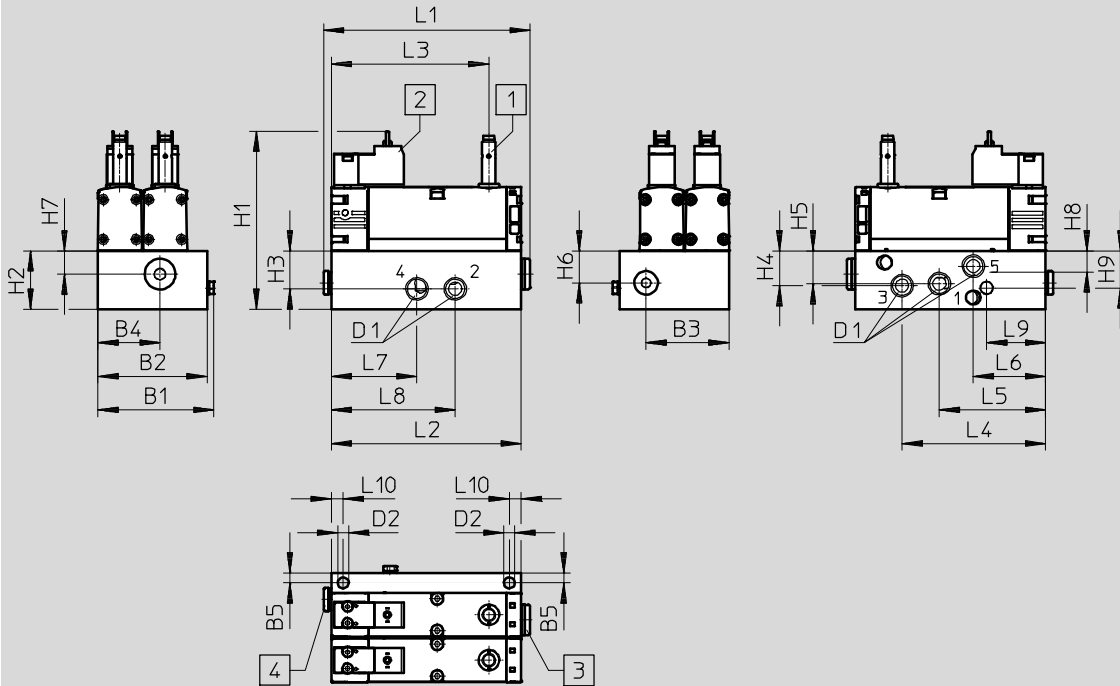

1 Proximity sensor PNP or NPN, size M8x1, plug connection to EN 61076-2-104

2 Electrical connection to EN 175301-803, type C

3 Pneumatic connection G $\frac{1}{4}$  sealed with blanking plug

4 Pneumatic connection G $\frac{1}{8}$  sealed with blanking plug

Type	B1	B2	B3	B4	B5	D1	D2	H1	H2	H3	H4	H5	H6	H7	H8	H9
VOFA-L26-T52-M-G14-1C1-APP	69	65	49.3	37	6	G $\frac{1}{4}$	6.5	105.8	34.6	22.6	20.7	19.5	19.1	13.8	9.1	22
VOFA-L26-T52-M-G14-1C1-ANP																

Type	L1	L2	L3	L4	L5	L6	L7	L8	L9	L10
VOFA-L26-T52-M-G14-1C1-APP	122.9	113.1	93.8	85.3	63.1	42.9	51	73.8	35	7.1
VOFA-L26-T52-M-G14-1C1-ANP										

# Control block VOFA with safety function

Technical data

FESTO

## Dimensions

Download CAD data → [www.festo.com](http://www.festo.com)

Decentralised individual connection variant VOFA-L26-T32C-...

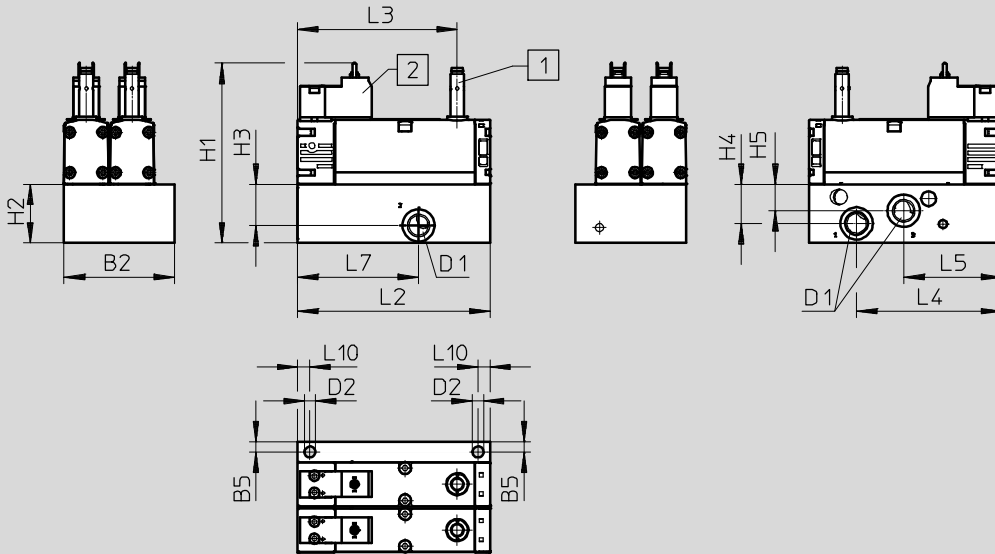

- 1 Proximity sensor PNP or NPN, size M8x1, plug connection to EN 61076-2-104
- 2 Electrical connection to EN 175301-803, type C

Type	B2	B5	D1	D2	H1	H2	H3	H4	H5	L2	L3	L4	L5	L7	L10
VOFA-L26-T32C-M-G14-1C1-APP	65	6	G1/4	6.5	105.8	34.6	24.3	23.1	15.6	113.1	93.8	85.3	57.6	71	7.1
VOFA-L26-T32C-M-G14-1C1-ANP															

Version for valve terminal VTSA/VTSA-F, VOFA-B26-T52-...

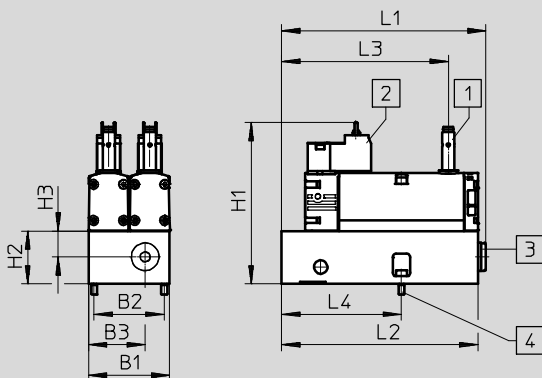

- 1 Proximity sensor PNP or NPN, size M8x1, plug connection to EN 61076-2-104
- 2 Electrical connection to EN 175301-803, type C
- 3 Pneumatic connection G1/4 sealed with blanking plug
- 4 2x screw with internal hex (2.5 A/F), M4x12 (included in the scope of delivery)

Type	B1	B2	B3	H1	H2	H3	L1	L2	L3	L4
VOFA-B26-T52-M-1C1-APP	53	46	37	105.8	34.6	17	133.7	128.5	109.2	78.5
VOFA-B26-T52-M-1C1-ANP										

# Control block VOFA with safety function

Ordering data – Control block

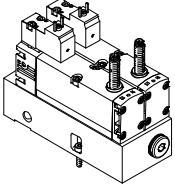
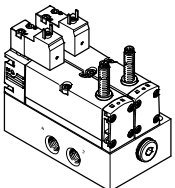
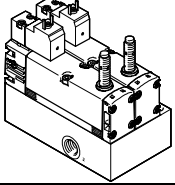
Ordering data							
	Valve function	Code	Switching output	Width [mm]	Weight [g]	Part No.	Type
Control block, version for valve terminal VTSA/VTSA-F							
	5/2-way valve, single solenoid, mechanical spring return, with switching position sensing via inductive sensor and 3-pin sensor push-in connector M8, mounted on intermediate plate for pneumatic interlinking	SP 2)	PNP	53	1,112	– 1)	<b>VOFA-B26-T52-M-1C1-APP</b>
		SN 2)	NPN	53	1,112	– 1)	<b>VOFA-B26-T52-M-1C1-ANP</b>
Control block, as decentralised individual connection variant							
	5/2-way valve, single solenoid, mechanical spring return, with switching position sensing via inductive sensor and 3-pin sensor push-in connector M8, mounted on individual sub-base	–	PNP	65	1,138	<b>569819</b>	<b>VOFA-L26-T52-M-G14-1C1-APP</b>
		–	NPN	65	1,138	<b>569820</b>	<b>VOFA-L26-T52-M-G14-1C1-ANP</b>
	3/2-way valve, mechanical spring return, with switching position sensing via inductive sensor and 3-pin sensor push-in connector M8, mounted on individual sub-base	–	PNP	65	1,134	<b>574011</b>	<b>VOFA-L26-T32C-M-G14-1C1-APP</b>
		–	NPN	65	1,134	<b>574012</b>	<b>VOFA-L26-T32C-M-G14-1C1-ANP</b>

1) The control block with safety function can only be ordered via the valve terminal configurator and therefore does not have a separate part number.

2) Code letter within the order code for a valve terminal configuration.









Note

The sensors contained in the valves must not be replaced. Incorrect assembly can result in

malfunctions or damage to the valve. Please contact Festo in the event of a malfunction.

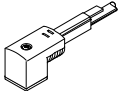
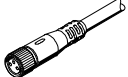
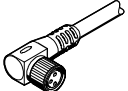
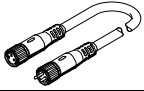
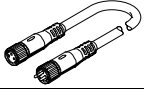
# Control block VOFA with safety function

Accessories

Ordering data					
Description		Part No.	Type		
Plug socket for electrical connection of individual valves					
	Angled socket, 3-pin, screw terminal, cable connector	PG7	<b>151687</b>	<b>MSSD-EB</b>	
		M12	<b>539712</b>	<b>MSSD-EB-M12</b>	
Illuminating seal for plug pattern to EN 175301-803, type C					
	For plug socket MSSD	<b>151717</b>	<b>MEB-LD-12-24DC</b>		
Connecting cable for electrical connection of individual valves					
	Angled socket, 3-pin, with switching status display via LED	2.5 m	<b>151688</b>	<b>KMEB-1-24-2,5-LED</b>	
		5 m	<b>151689</b>	<b>KMEB-1-24-5-LED</b>	
		10 m	<b>193457</b>	<b>KMEB-1-24-10-LED</b>	
Connecting cable for electrical connection of sensors for switching position sensing					
	<ul style="list-style-type: none"> <li>• Straight socket, 3-pin, plug M8</li> <li>• Open end, 3-wire</li> </ul>	2.5 m	<b>541333</b>	<b>NEBU-M8G3-K-2,5-LE3</b>	
		5 m	<b>541334</b>	<b>NEBU-M8G3-K-5-LE3</b>	
	<ul style="list-style-type: none"> <li>• Angled socket, 3-pin, plug M8</li> <li>• Open end, 3-wire</li> </ul>	2.5 m	<b>541338</b>	<b>NEBU-M8-W3-K-2,5-LE3</b>	
		5 m	<b>541341</b>	<b>NEBU-M8W3-K-5-LE3</b>	
	<ul style="list-style-type: none"> <li>• Angled socket, rotatable, 3-pin, plug M8</li> <li>• Open end, 3-wire</li> </ul>	2.5 m	<b>8001660</b>	<b>NEBU-M8R3-K-2,5-LE3</b>	
		5 m	<b>8001661</b>	<b>NEBU-M8R3-K-5-LE3</b>	
	Straight socket, straight plug, 3-pin, 4-pin plug M8	2.5 m	<b>554037</b>	<b>NEBU-M8G3-K-2,5-M8G4</b>	
	Modular system for connecting cables	–	–	<b>NEBU-...</b> → Internet: nebu	
Silencer					
	Connecting thread	G $\frac{1}{4}$	<b>2316</b>	<b>U-<math>\frac{1}{4}</math></b>	
Push-in fitting					
	Connecting thread G $\frac{1}{4}$ for tubing O.D.	12 mm	10 pieces	<b>186350</b>	<b>QS-G<math>\frac{1}{4}</math>-12</b>
		10 mm	10 pieces	<b>186101</b>	<b>QS-G<math>\frac{1}{4}</math>-10</b>
		8 mm	10 pieces	<b>186099</b>	<b>QS-G<math>\frac{1}{4}</math>-8</b>
Blanking plug					
	Connecting thread	G $\frac{1}{4}$	10 pieces	<b>3569</b>	<b>B-<math>\frac{1}{4}</math></b>