

Vacuum generators

FESTO



Vacuum generators

Key features

FESTO

Product overview

Vacuum generator

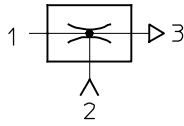

All Festo vacuum generators have a single-stage design and operate according to the venturi principle. The product families described below

have been designed for a wide range of applications. The different performance classes of the individual

product families make it possible to select vacuum generators tailored to suit specific requirements.

Standard and inline ejectors

VN-...

→ 13



- Nominal size 0.45 ... 3 mm
- Max. vacuum 93%
- Temperature range 0 ... +60 °C
- A range of extremely effective generators suitable for use directly in the workplace
- Available as straight or T-shaped housing
- Low space requirement
- Low-cost
- No wearing parts
- Extremely fast evacuation time
- Vacuum switch (optional)
- Optional with additional functions:
 - integrated eject pulse
 - electric control for vacuum ON/OFF
 - combination of eject pulse and control

VAD-.../VAK-...

Technical data → Internet: vad



- Nominal size 0.5 ... 1.5 mm
- Max. vacuum 80%
- Temperature range -20 ... +80 °C
- Range of vacuum generators with sturdy aluminium casing
- VAK-...: Built-in reservoir
- VAD-...: Connection for additional external reservoir
- Maintenance-free
- VAK-...: Reliable setting down of workpieces

Vacuum generators

Key features

Compact ejectors

VADM-.../VADMI-...

Technical data → Internet: vadm



- Nominal size
0.45 ... 3 mm
- Max. vacuum
84%
- Temperature range
0 ... +60 °C
- Compact design
- Minimal installation work required
- Short response times
- Built-in solenoid valve (on/off)
- VADMI-...: Additional built-in solenoid valve for ejector pulse
- Filter with display
- Air-saving circuit (optional)
- Vacuum switch (optional)
- Reliable setting down of workpieces

VAD-M-.../VAD-M-I-...

Technical data → Internet: vad-m



- Nominal size
0.7 ... 2 mm
- Max. vacuum
85%
- Temperature range
0 ... +40 °C
- Compact design
- Minimal installation work required
- Short response times
- Built-in solenoid valve (on/off)
- VAD-M-I-...: Additional built-in solenoid valve for ejector pulse
- Reliable setting down of workpieces

Vacuum generators VN

Features

FESTO

At a glance

- Vacuum generators for high vacuum levels of up to 93%
- Laval nozzles in six nominal sizes:
 - 0.45 mm
 - 0.7 mm
 - 0.95 mm
 - 1.4 mm
 - 2.0 mm
 - 3.0 mm
- Vacuum generators for high suction rates resulting in very short evacuation times
- Low space requirement
- Compact and sturdy design
- Wear-resistant and maintenance-free
- Modular system: Large selection of different types
- Can be used directly in the workplace, making them very effective
- Plastic housing
- Versatile connection options:
 - Push-in connector QS
 - Screw-in thread
 - Push-in sleeve
 - Screw-in silencer
- Easy mounting thanks to the double-sided latching function of the mounting plate
- With or without integrated vacuum switch to monitor the vacuum with PNP output

Two housing types

Standard T-type

Connection options:

- QS push-in connectors
- Female thread
- Male thread
- Silencers

Mounting options:

- Direct mounting with screws
- Indirect mounting by latching onto a mounting plate. This plate is suitable for H-rails 35x7.5 to DIN EN 50 022.

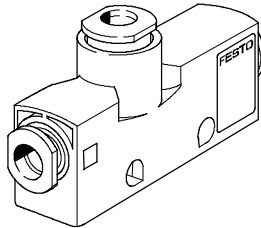

In-line version

Connection options:

- QS push-in connectors
- Push-in sleeve

Mounting options:

Extremely compact housing with supply and vacuum port arranged in a line and with unducted exhaust air. As a result, this housing type can be installed directly into the tubing line.

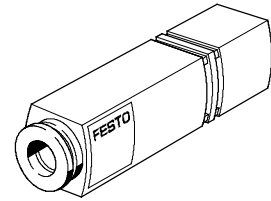

Two operating principles

Standard

- T-type housing

Design:

Supply port at 90° to vacuum port. The drawn-in flow is diverted 90° from V to R.

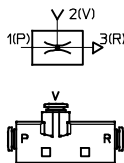

Inline

- T-type housing with exhaust port
- Straight housing without exhaust port for space-saving assembly in a tubing line or directly in the suction cup holder

Design:

Supply and vacuum ports arranged in-line.

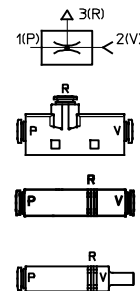

Vacuum generators VN

Features

Two variants

High vacuum

up to 93%

Vacuum p_u as a function of operating pressure p_1

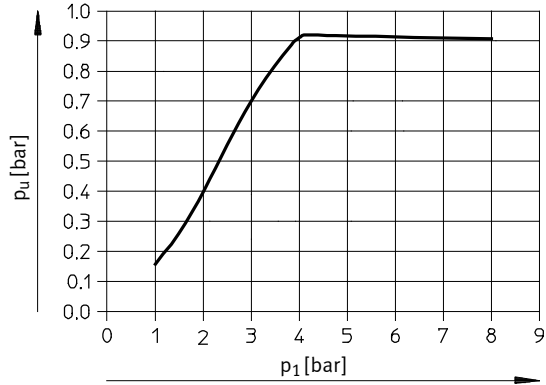

High suction volume

up to 339 l/min which results in very short evacuation times

Suction rate q_{ns} as a function of operating pressure p_1

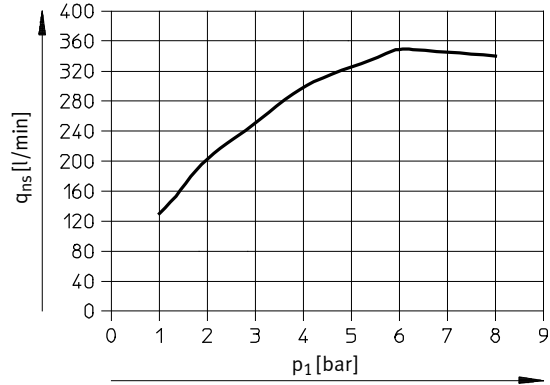

System comparison

High vacuum – high suction volume

The first type of generator has been optimised for the generation of high vacuum at comparatively lower suction flow rates.

The second type of generator, on the other hand, can achieve very short evacuation times because of the high suction flow rate at relatively low vacuum.

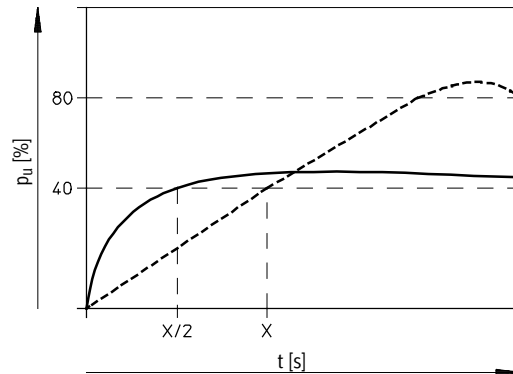





----- High vacuum
 ——— High suction volume

Vacuum generators VN

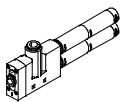
Product range overview

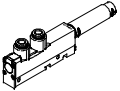
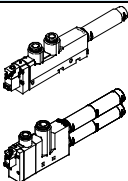
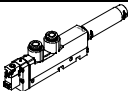
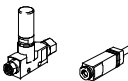
FESTO

Function	Version	Type	Nominal size of laval nozzle [mm]	Grid dimension							Pneumatic connection 1		
				T-type					Inline			Push-in fitting PQ	Female thread PI
				10 [mm]	14 [mm]	16 [mm]	18 [mm]	24 [mm]	10 [mm]	13 [mm]	14.5 [mm]		
High vacuum	Standard H												
		VN-05-H	0.45	■	-	-	-	-	-	-	-	■	■
		VN-07-H	0.7	■	-	-	-	-	-	-	-	■	■
		VN-10-H	0.95	-	■	-	■	-	-	-	-	■	■
		VN-14-H	1.4	-	-	-	■	-	-	-	-	■	■
		VN-20-H	2.0	-	-	-	-	■	-	-	-	■	■
		VN-30-H	3.0	-	-	-	-	■	-	-	-	■	■
	Standard H with integrated vacuum switch												
		VN-05-H-...-P	0.45	-	-	■	-	-	-	-	-	■	-
		VN-07-H-...-P	0.7	-	-	■	-	-	-	-	-	■	-
		VN-10-H-...-P	0.95	-	-	-	■	-	-	-	-	■	-
	Standard H with pneumatic ejector pulse												
		VN-05-H-...-A	0.45	-	■	-	-	-	-	-	-	■	■
		VN-07-H-...-A	0.7	-	■	-	-	-	-	-	-	■	■
		VN-10-H-...-A	0.95	-	-	-	■	-	-	-	-	■	■
		VN-14-H-...-A	1.4	-	-	-	■	-	-	-	-	■	■
	Standard H with electrical on-off valve												
		VN-05-H-...-M	0.45	-	■	-	-	-	-	-	-	■	-
		VN-07-H-...-M	0.7	-	■	-	-	-	-	-	-	■	-
		VN-10-H-...-M	0.95	-	-	-	■	-	-	-	-	■	-
		VN-14-H-...-M	1.4	-	-	-	■	-	-	-	-	■	-
		VN-20-H-...-M	2.0	-	-	-	-	■	-	-	-	■	-
		VN-30-H-...-M	3.0	-	-	-	-	■	-	-	-	■	-
	Standard H with electrical on-off valve and pneumatic ejector pulse												
	VN-05-H-...-B	0.45	-	■	-	-	-	-	-	-	■	-	
	VN-07-H-...-B	0.7	-	■	-	-	-	-	-	-	■	-	
	VN-10-H-...-B	0.95	-	-	-	■	-	-	-	-	■	-	
	VN-14-H-...-B	1.4	-	-	-	■	-	-	-	-	■	-	
Inline M													
	VN-05-M	0.45	■	-	-	-	-	-	-	-	■	■	
			-	■	-	-	-	■	-	-	■	-	
	VN-07-M	0.7	■	-	-	-	-	-	-	-	■	■	
			-	■	-	-	-	■	-	-	■	-	
	VN-10-M	0.95	-	-	-	-	-	-	■	-	■	-	
	Inline M with pneumatic ejector pulse												
	VN-05-M-...-A	0.45	-	-	-	-	-	-	-	■	■	-	
	VN-07-M-...-A	0.7	-	-	-	-	-	-	-	■	■	-	

Vacuum generators VN

Product range overview





FESTO

Type	Vacuum connection				Pneumatic connection 3			Switching function		→ Page/ Internet
	Push-in fitting VQ	Female thread VI	Male thread VA	Push-in sleeve VT	Push-in fitting RQ	Female thread RI	Silencer RO	Fixed hysteresis O1	Variable hysteresis O2	
Standard H										
VN-05-H	■	■	- ■	-	■	■	■	-	-	11
VN-07-H	■	■	- ■	-	■	■	■	-	-	
VN-10-H	■	■ -	■	-	■	■ -	■	-	-	
VN-14-H	■	■	■	-	■	■	■	-	-	
VN-20-H	■	■	■	-	-	-	■	-	-	
VN-30-H	■	■	■	-	-	-	■	-	-	
Standard H with integrated vacuum switch										
VN-05-H...-P	■	-	-	-	-	-	-	■	■	26
VN-07-H...-P		-	-	-	-	-	-	-	-	
VN-10-H...-P		-	-	-	-	-	-	-	-	
Standard H with pneumatic ejector pulse										
VN-05-H...-A	■	■	-	-	-	-	■	-	-	32
VN-07-H...-A										
VN-10-H...-A										
VN-14-H...-A										
Standard H with electrical on-off valve										
VN-05-H...-M	■	-	-	-	-	-	■	-	-	32
VN-07-H...-M										
VN-10-H...-M										
VN-14-H...-M										
VN-20-H...-M										
VN-30-H...-M										
Standard H with electrical on-off valve and pneumatic ejector pulse										
VN-05-H...-B	■	-	-	-	-	-	■	-	-	32
VN-07-H...-B										
VN-10-H...-B										
VN-14-H...-B										
Inline M										
VN-05-M	■	■	-	-	■	■	■	-	-	11
	■	-	-	■	-	-	-	-	-	
VN-07-M	■	■	-	-	■	■	■	-	-	
	■	-	-	■	-	-	-	-	-	
VN-10-M	■	-	-	-	-	-	-	-	-	
Inline M with pneumatic ejector pulse										
VN-05-M...-A	■	-	-	-	-	-	-	-	-	32
VN-07-M...-A										

Vacuum generators VN

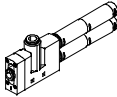
Product range overview

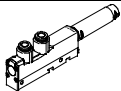
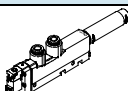
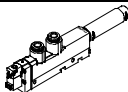
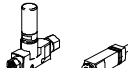
FESTO

Function	Version	Type	Nominal size of laval nozzle [mm]	Grid dimension							Pneumatic connection 1		
				T-type					Inline		Push-in fitting PQ	Female thread PI	
				10 [mm]	14 [mm]	16 [mm]	18 [mm]	24 [mm]	10 [mm]	13 [mm]			14.5 [mm]
High suction rate	Standard L												
		VN-05-L	0.45	■	-	-	-	-	-	-	-	■	■
		VN-07-L	0.7	-	■	-	-	-	-	-	-	■	■
		VN-10-L	0.95	-	■	-	■	-	-	-	-	■	■
		VN-14-L	1.4	-	-	-	■	-	-	-	-	■	■
		VN-20-L	2.0	-	-	-	-	■	-	-	-	■	■
		VN-30-L	3.0	-	-	-	-	■	-	-	-	■	■
	Standard L with integrated vacuum switch												
		VN-05-L...-P	0.45	-	-	■	-	-	-	-	-	■	-
		VN-07-L...-P	0.7	-	-	■	-	-	-	-	-	■	-
		VN-10-L...-P	0.95	-	-	-	■	-	-	-	-	■	-
	Standard L with pneumatic ejector pulse												
		VN-05-L...-A	0.45	-	■	-	-	-	-	-	-	■	■
		VN-07-L...-A	0.7	-	■	-	-	-	-	-	-	■	■
		VN-10-L...-A	0.95	-	-	-	■	-	-	-	-	■	■
		VN-14-L...-A	1.4	-	-	-	■	-	-	-	-	■	■
	Standard L with electrical on-off valve												
		VN-05-L...-M	0.45	-	■	-	-	-	-	-	-	■	-
		VN-07-L...-M	0.7	-	■	-	-	-	-	-	-	■	-
		VN-10-L...-M	0.95	-	-	-	■	-	-	-	-	■	-
		VN-14-L...-M	1.4	-	-	-	■	-	-	-	-	■	-
	Standard L with electrical on-off valve and pneumatic ejector pulse												
		VN-05-L...-B	0.45	-	■	-	-	-	-	-	-	■	-
		VN-07-L...-B	0.7	-	■	-	-	-	-	-	-	■	-
VN-10-L...-B		0.95	-	-	-	■	-	-	-	-	■	-	
VN-14-L...-B		1.4	-	-	-	■	-	-	-	-	■	-	
Inline N													
	VN-05-N	0.45	-	■	-	-	-	-	-	-	■	■	
			-	-	-	-	-	-	■	-	■	-	
Inline N with pneumatic ejector pulse													
	VN-05-N...-A	0.45	-	-	-	-	-	-	-	■	■	-	
	VN-07-N...-A	0.7	-	-	-	-	-	-	-	■	■	-	

Vacuum generators VN

Product range overview

FESTO

Type	Vacuum connection				Pneumatic connection 3			Switching function		→ Page/ Internet
	Push-in fitting VQ	Female thread VI	Male thread VA	Push-in sleeve VT	Push-in fitting RQ	Female thread RI	Silencer RO	Fixed hysteresis O1	Variable hysteresis O2	
Standard L										
VN-05-L	■	■	- ■	-	■	■	■	-	-	11
VN-07-L	■	■	■	-	■	■	■	-	-	
VN-10-L	■	■ -	■	-	■	■ -	■	-	-	
VN-14-L	■	■	■	-	■	■	-	-	-	
VN-20-L	■	■	■	-	-	-	■	-	-	
VN-30-L	-	■	■	-	-	-	■	-	-	
Standard L with integrated vacuum switch										
VN-05-L-...-P	■	-	-	-	-	-	-	■	■	26
VN-07-L-...-P										
VN-10-L-...-P										
Standard L with pneumatic ejector pulse										
VN-05-L-...-A	■	■	-	-	-	-	■	-	-	32
VN-07-L-...-A										
VN-10-L-...-A										
VN-14-L-...-A										
Standard L with electrical on-off valve										
VN-05-L-...-M	■	-	-	-	-	-	■	-	-	32
VN-07-L-...-M										
VN-10-L-...-M										
VN-14-L-...-M										
Standard L with electrical on-off valve and pneumatic ejector pulse										
VN-05-L-...-B	■	-	-	-	-	-	■	-	-	32
VN-07-L-...-B										
VN-10-L-...-B										
VN-14-L-...-B										
Inline N										
VN-05-N	■ ■	■ -	- -	- ■	■ -	■ -	■ -	- -	- -	11
Inline N with pneumatic ejector pulse										
VN-05-N-...-A	■	-	-	-	-	-	-	-	-	32
VN-07-N-...-A										

Vacuum generators VN

Product range overview

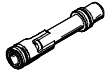
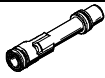
Function	Version	Type	Nominal size of laval nozzle	→ Page/ Internet
			[mm]	
High vacuum	Vacuum generator cartridge, standard H			
		VN-05-H	0.45	43
		VN-07-H	0.7	
		VN-10-H	0.95	
		VN-14-H	1.4	
		VN-20-H	2.0	
High suction rate	Vacuum generator cartridge, standard L			
		VN-05-L	0.45	43
		VN-07-L	0.7	
		VN-10-L	0.95	
		VN-14-L	1.4	
		VN-20-L	2.0	

Vacuum generators VN

Peripherals overview

FESTO

VN-05/07/10/14

VN-20/30

Inline

T-type

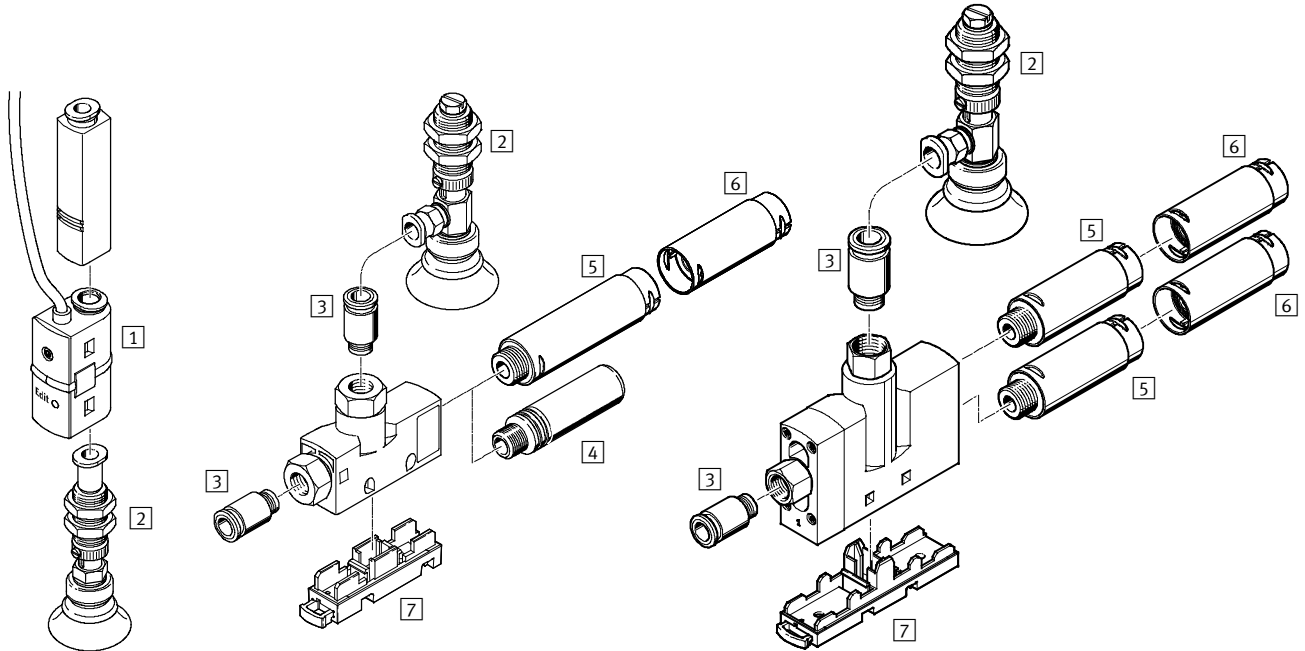

Mounting attachments and accessories

	VN-05/07/10/14					VN-20/30	→ Page/Internet
	Inline		T-type			T-type	
	10 mm	13 mm	10 mm	14 mm	18 mm	24 mm	
1 Pressure switch SDE5		■				■	sde5
2 Suction gripper ESG		■				■	esg
3 Push-in fitting QS		-			■	■	qs
4 Silencer UO		-	■	■	-	-	uo
5 Silencer UOM		-	-	-	■	■	uom
6 Silencer extension UOMS		-	-	-	■	■	uoms
7 Mounting plate VN-T		-		■		■	vn-t
- Suction cup holder ESH		■			■	■	esh
- suction cup ESS		■			■	■	ess

Vacuum generators VN

Type codes

VN – 05 – H – T2 – PQ1 – VQ1 – RQ1

Type

VN	Vacuum generator
----	------------------

Nominal size of laval nozzle [mm]

05	0.45
07	0.7
10	0.95
14	1.4
20	2.0
30	3.0

Ejector characteristic

H	High vacuum/Standard
L	High suction rate/Standard
M	High vacuum/Inline
N	High suction rate/Inline

Housing type

I2	Inline, grid dimensions 10 mm
I3	Inline, grid dimensions 13 mm
T2	T-type, grid dimensions 10 mm
T3	T-type, grid dimensions 14 mm
T4	T-type, grid dimensions 18 mm
T6	T-type, grid dimensions 24 mm

Pneumatic connection 1

PQ1	Push-in fitting QS-4
PQ2	Push-in fitting QS-6
PQ4	Push-in fitting QS-10
PI2	Female thread M5
PI4	Female thread G $\frac{1}{8}$
PI5	Female thread G $\frac{3}{4}$

Vacuum connection

VQ1	Push-in fitting QS-4
VQ2	Push-in fitting QS-6
VQ3	Push-in fitting QS-8
VQ5	Push-in fitting QS-12
VI2	Female thread M5
VI4	Female thread G $\frac{1}{8}$
VI5	Female thread G $\frac{3}{4}$
VI6	Female thread G $\frac{3}{8}$
VA4	Male thread G $\frac{1}{8}$
VA5	Male thread G $\frac{3}{4}$
VT1	Push-in sleeve \varnothing 4 mm
VT2	Push-in sleeve \varnothing 6 mm

Pneumatic connection 3

RQ1	Push-in fitting QS-4
RQ2	Push-in fitting QS-6
RQ3	Push-in fitting QS-8
RI2	Female thread M5
RI4	Female thread G $\frac{1}{8}$
RI5	Female thread G $\frac{3}{4}$
RO1	Silencer UO, minimal resistance
RO2	Silencer UOM, minimal resistance



Note

Possible combinations can be found in the ordering data.

Vacuum generators VN

Technical data

Function
Standard

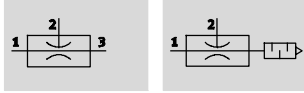

Inline

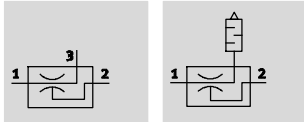

- - Temperature range
0 ... +60 °C
- - Operating pressure
1 ... 8 bar

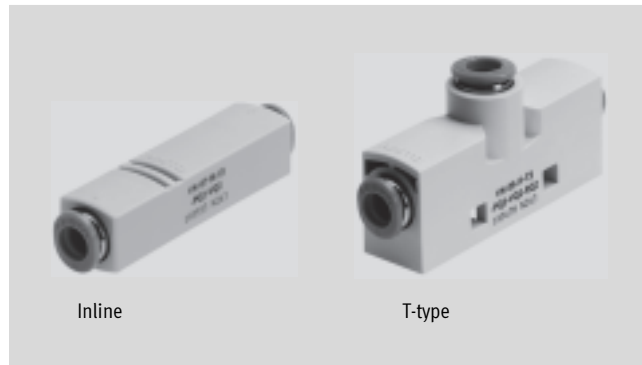

General technical data – Standard											
Design		T-type									
Type		VN-05		VN-07		VN-10		VN-14	VN-20	VN-30	
Grid dimension	[mm]	10	14	10	14	14	18	18	24	24	
Nominal size of laval nozzle	[mm]	0.45		0.7		0.95		1.4	2.0	3.0	
Ejector characteristic		High vacuum H									
		High suction rate L			–		High suction rate L				
Pneumatic connection 1	Push-in fitting	QS-4	QS-6	QS-4	QS-6	QS-6	QS-6	QS-6	QS-10	QS-10	
	Female thread	M5	G1/8	M5	G1/8	G1/8	–	G1/8	G1/4	G1/4	
Vacuum connection	Push-in fitting	QS-4	QS-6	QS-4	QS-6	QS-6	QS-8	QS-8	QS-12	QS-12	
	Male thread	–	G1/8	–	G1/8	G1/8	G1/4	G1/4	G1/4	G1/4	
	Female thread	M5	G1/8	M5	G1/8	G1/8	–	G1/4	G3/8	G3/8	
Pneumatic connection 3	Push-in fitting	QS-4	QS-6	QS-4	QS-6	QS-6	QS-8	QS-8	–	–	
	Female thread	M5	G1/8	M5	G1/8	G1/8	–	G1/4	–	–	
	Silencer	min. resis.	min. resis.	min. resis.	min. resis.	min. resis.	min. resis.	min. resis.	min. resis.	min. resis.	
Type of mounting (max. tightening torque)		Via through-holes (0.5 Nm)							Via through-holes (0.8 Nm)		
		Via accessories									
Assembly position		Any									

General technical data – Inline										
Design		T-type				Inline				
Type		VN-05		VN-07		VN-05		VN-07		VN-10
Grid dimension	[mm]	10	14	10	14	10	13	10	13	13
Nominal size of laval nozzle	[mm]	0.45		0.7		0.45		0.7		0.95
Ejector characteristic		High vacuum M								
		–	High suction rate N	–	–	High suction rate N	–	–	–	–
Pneumatic connection 1	Push-in fitting	QS-4	QS-6	QS-4	QS-6	QS-4	QS-6	QS-4	QS-6	QS-6
	Female thread	M5	G1/8	M5	G1/8	–				
Vacuum connection	Push-in fitting	QS-4	QS-6	QS-4	QS-6	QS-4	QS-6	QS-4	QS-6	QS-6
	Female thread	M5	G1/8	M5	G1/8	–				
	Push-in sleeve	–				4	6	4	6	–
Pneumatic connection 3	Push-in fitting	QS-4	QS-6	QS-4	QS-6	Non-ducted				
	Female thread	M5	G1/8	M5	G1/8					
	Silencer	min. resis.	min. resis.	min. resis.	min. resis.					
Type of mounting (max. tightening torque)		Via through-holes (0.5 Nm)				Inline installation				
		Via accessories								
Assembly position		Any								

- | - Note: This product conforms to ISO 1179-1 and to ISO 228-1

Vacuum generators VN

Technical data

FESTO

Operating and environmental conditions		
Operating pressure	[bar]	1 ... 8
Nominal operating pressure	[bar]	6
Operating medium		Compressed air in accordance with ISO 8573-1:2010 [7:4:4]
Note on operating/pilot medium		Operation with lubricated medium not possible
Ambient temperature	[°C]	0 ... +60
Temperature of medium	[°C]	0 ... +60
Corrosion resistance class CRC ¹⁾		1 (with push-in fitting)
Corrosion resistance class CRC ¹⁾		2 (without push-in fitting; exception: VN-...-T3-...-R01 → CRC 1)

1) Corrosion resistance class 1 according to Festo standard 940 070

Components requiring low corrosion resistance. Transport and storage protection. Parts that do not have primarily decorative surface requirements, e.g. in internal areas that are not visible or behind covers.

Corrosion resistance class 2 according to Festo standard 940 070

Components requiring moderate corrosion resistance. Externally visible parts with primarily decorative surface requirements which are in direct contact with a normal industrial environment or media such as coolants or lubricating agents.

Performance data – High vacuum										
Ejector characteristic		Standard H						Inline M		
Nominal size of laval nozzle	[mm]	0.45	0.7	0.95	1.4	2.0	3.0	0.45	0.7	0.95
Max. vacuum	[%]	88	88	89	88	92	93	86	86	86
Operating pressure for max. vacuum	[bar]	4.5	4.7	4.5	5.0	3.5	3.7	6.0	5.8	5.8
Max. suction rate with respect to atmosphere	[l/min]	6.2	16	25	51.6	98	186	6.1	13.5	28
Operating pressure for max. suction rate	[bar]	2.1	2.1	3.1	5.1	2.0	5.0	6.3	7.0	5.0
Air supply time at nominal operating pressure 6 bar (for 1 l volume)	[s]	4.8	1.9	1.1	0.5	0.2	0.1	4.7	2.1	0.96
Noise level at nominal operating pressure 6 bar	[dB (A)]	53	64	74 (R01) 71 (R02)	69	63	78	53	59	–

Performance data – High suction rate								
Ejector characteristic		Standard L					Inline N	
Nominal size of laval nozzle	[mm]	0.45	0.7	0.95	1.4	2.0	3.0	0.45
Max. suction rate with respect to atmosphere	[l/min]	15.7	38.8	62.7	90.0	188.0	339.0	12.0
Operating pressure for max. suction rate	[bar]	5.0	6.2	4.0	8.0	3.0	6.0	6.0
Air supply time at nominal operating pressure 6 bar (for 1 l volume)	[s]	1.7	0.5	0.46	0.25	0.15	0.1	1.57
Noise level at nominal operating pressure 6 bar	[dB (A)]	53	66	73 (R01) 72 (R02)	77	60	70	48

Vacuum generators VN

Technical data

FESTO

Materials

Sectional view

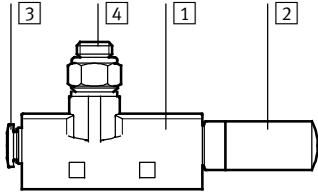

Vacuum generator VN-05/07/10/14

1	Housing		POM-reinforced
2	Silencer	RO1	PE
		RO2	Die-cast aluminium, POM, PU foam
3	Push-in fitting		Nickel plated brass
4	Connecting thread	VA	Wrought aluminium alloy
		PI, VI, RI	Anodised wrought aluminium alloy
		T3-RO1	Nickel plated brass
-	Jet nozzle		Wrought aluminium alloy
-	Receiver nozzle		POM
-	Seals		NBR
Note on materials			RoHS-compliant
			Free of copper and PTFE
		RO2	Contains paint-wetting impairment substances

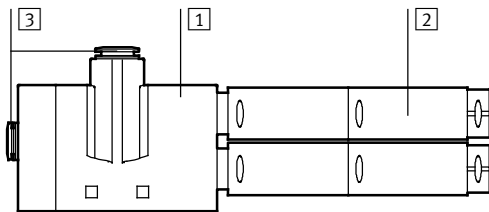

Vacuum generator VN-20/30

1	Housing		POM-reinforced
2	Silencer		Die-cast aluminium, POM, PU foam
3	Push-in fitting		Nickel plated brass
-	Connecting thread	VA	Wrought aluminium alloy
		PI, VI	Anodised wrought aluminium alloy
-	Jet nozzle		Wrought aluminium alloy
-	Receiver nozzle		POM
-	Seals		NBR
Note on materials			RoHS-compliant
			Free of copper and PTFE
			Contains paint-wetting impairment substances

Vacuum generators VN

Technical data

FESTO

Vacuum p_u as a function of operating pressure p_1

High vacuum

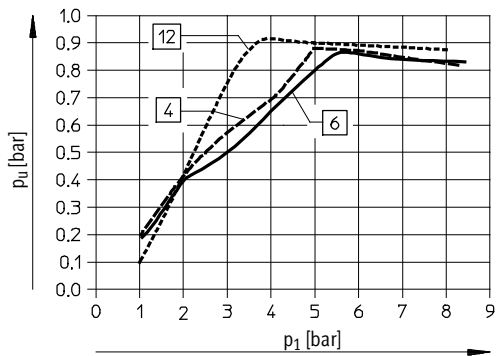
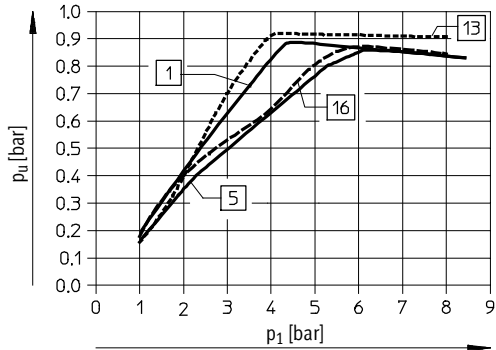

Standard:

- 1 VN-05-H-...
- VN-07-H-...
- VN-10-H-...
- 4 VN-14-H-...
- 12 VN-20-H-...
- 13 VN-30-H-...

Inline:

- 5 VN-05-M-...
- 6 VN-07-M-...
- 16 VN-10-M-...

High suction rate

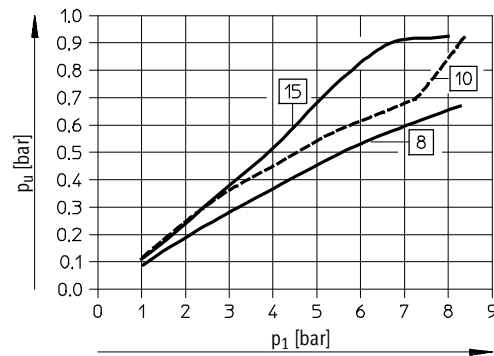
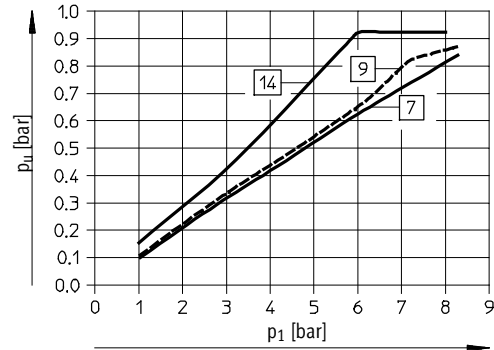

Standard:

- 7 VN-05-L-...
- 8 VN-07-L-...
- 9 VN-10-L-...
- 10 VN-14-L-...
- 14 VN-20-L-...
- 15 VN-30-L-...

Inline:

- 8 VN-05-N-...

Vacuum generators VN

Technical data

FESTO

Evacuation time t as a function of vacuum p_u for 1 l volume at 6 bar operating pressure

High vacuum

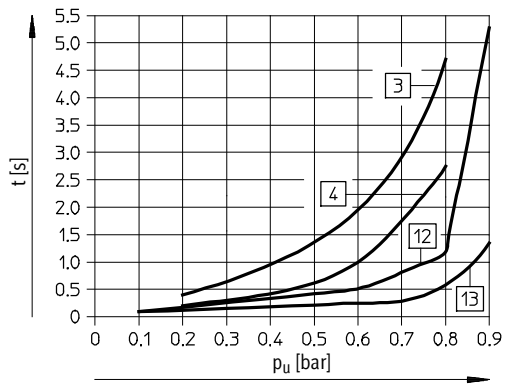
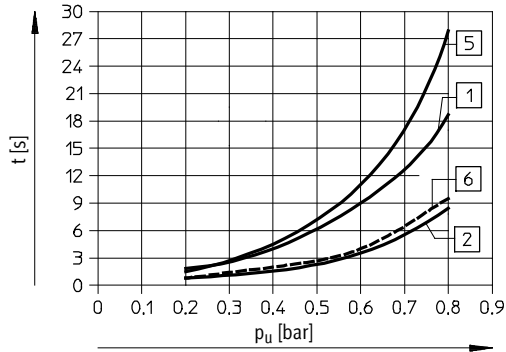

Standard:

- 1 VN-05-H...
- 2 VN-07-H...
- 3 VN-10-H...
- 4 VN-14-H...
- 12 VN-20-H...
- 13 VN-30-H...

Inline:

- 5 VN-05-M...
- 6 VN-07-M...
- 3 VN-10-M...

High suction rate

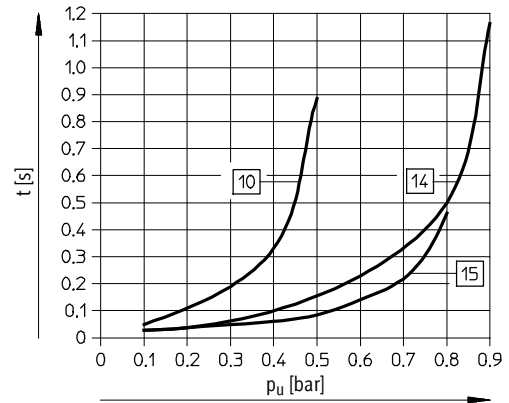
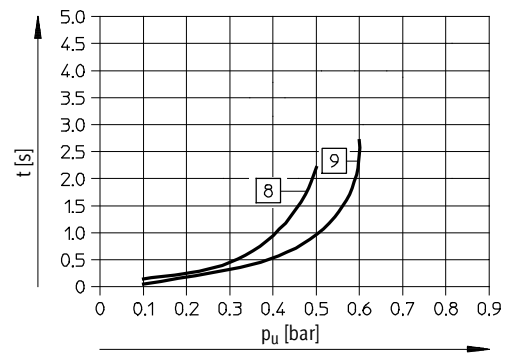
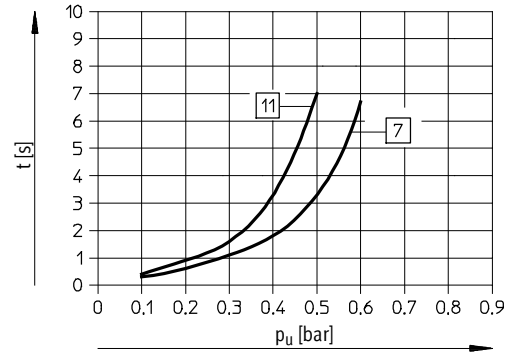

Standard:

- 7 VN-05-L...
- 8 VN-07-L...
- 9 VN-10-L...
- 10 VN-14-L...
- 14 VN-20-L...
- 15 VN-30-L...

Inline:

- 11 VN-05-N...

Vacuum generators VN

Technical data

FESTO

Suction rate q_{ns} (with respect to atmosphere) as a function of operating pressure p_1

High vacuum

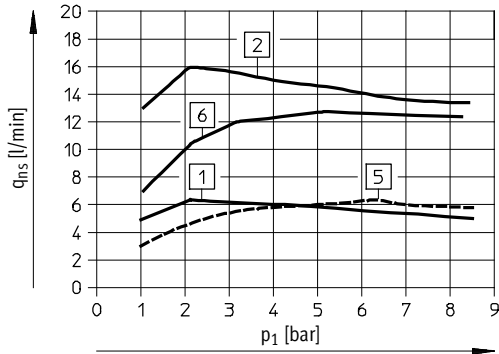

High suction rate

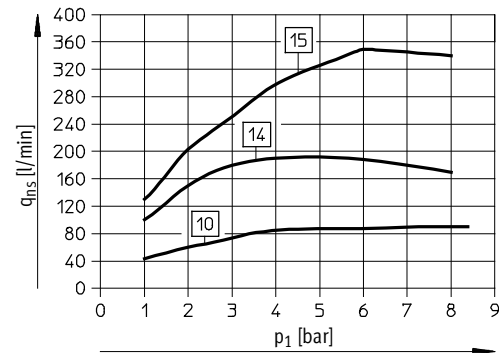
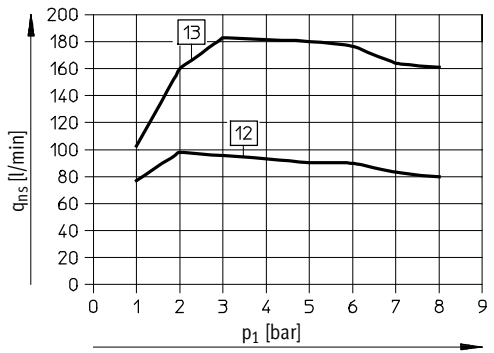
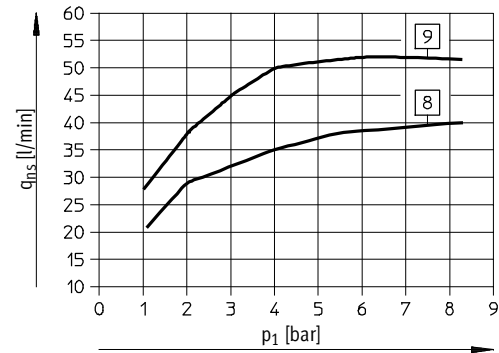
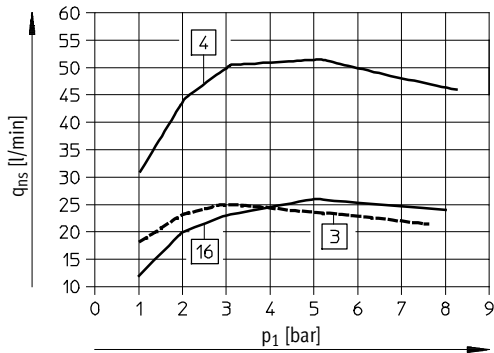
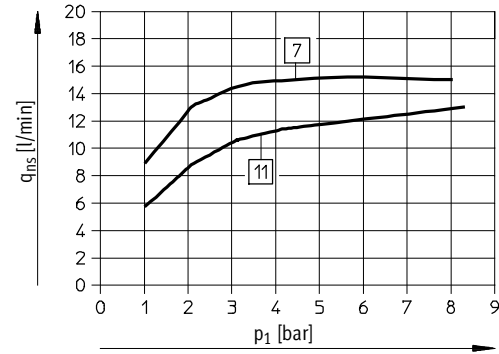

Standard:

- 1 VN-05-H...
- 2 VN-07-H...
- 3 VN-10-H...
- 4 VN-14-H...
- 12 VN-20-H...
- 13 VN-30-H...

Inline:

- 5 VN-05-M...
- 6 VN-07-M...
- 16 VN-10-M...

Standard:

- 7 VN-05-L...
- 8 VN-07-L...
- 9 VN-10-L...
- 10 VN-14-L...
- 14 VN-20-L...
- 15 VN-30-L...

Inline:

- 11 VN-05-N...

Vacuum generators VN

Technical data

FESTO

Air consumption q_n as a function of operating pressure p_1

High vacuum/high suction rate

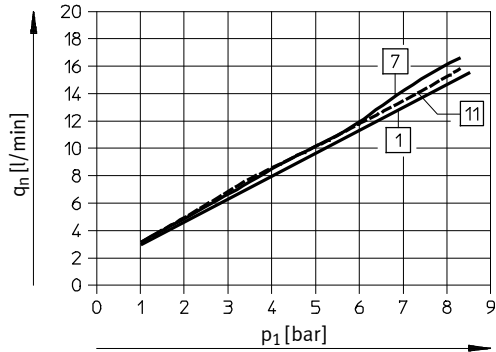

Standard:

- 1 VN-05-H-...
- 7 VN-05-L-...

Inline:

- 1 VN-05-M-...
- 11 VN-05-N-...

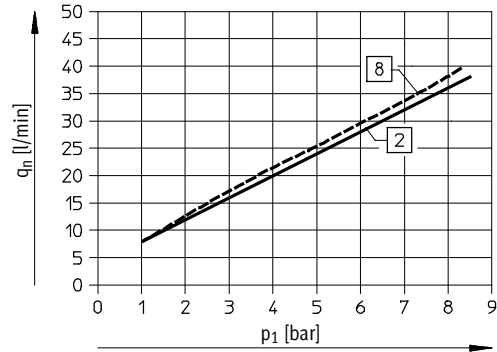

Standard:

- 2 VN-07-H-...
- 8 VN-07-L-...

Inline:

- 2 VN-07-M-...

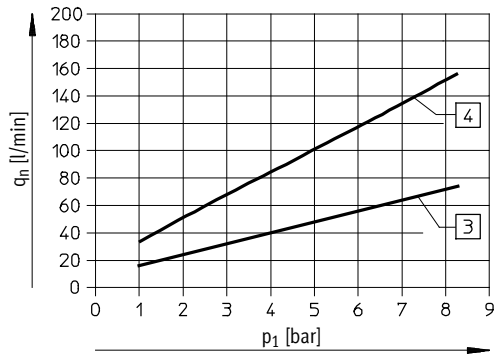

Standard:

- 3 VN-10-H-...
VN-10-L-...
- 4 VN-14-H-...
VN-14-L-...

Inline:

- 3 VN-10-M-...

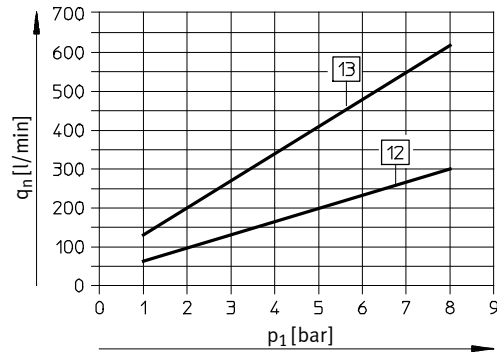

Standard:

- 12 VN-20-H-...
VN-20-L-...
- 13 VN-30-H-...
VN-30-L-...

Vacuum generators VN

Technical data

FESTO

Dimensions – T-type/Standard, VN-05/07/10/14

Download CAD data → www.festo.com

VN-...-T...-PQ...-VQ...-RQ...

VN-...-T...-PQ...-VQ...-RO...

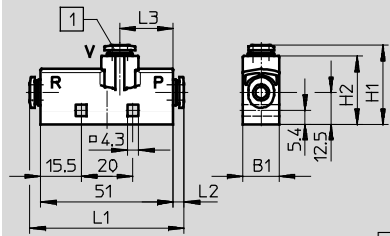

1 Push-in fitting

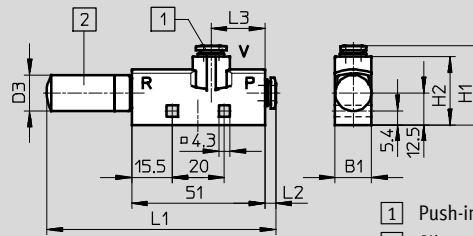

1 Push-in fitting
2 Silencer

VN-...-T...-PQ...-VA...-RQ...

VN-...-T...-PQ...-VA...-RO...

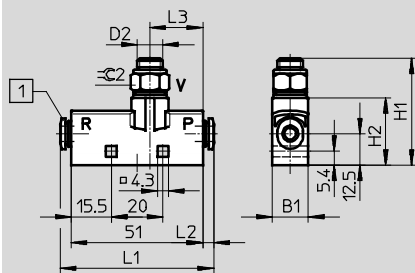

1 Push-in fitting

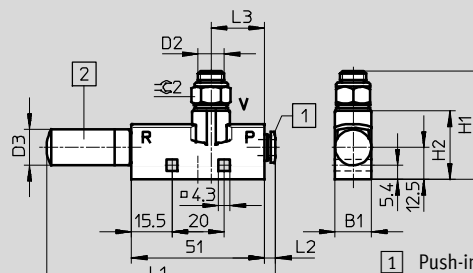

1 Push-in fitting
2 Silencer

VN-...-T...-PI...-VI...-RI...

VN-...-T...-PI...-VI...-RO...

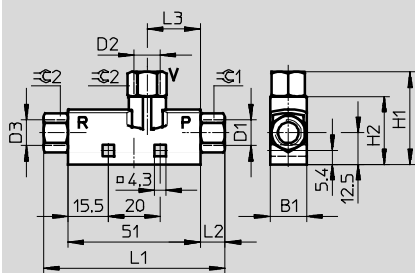

1 Push-in fitting

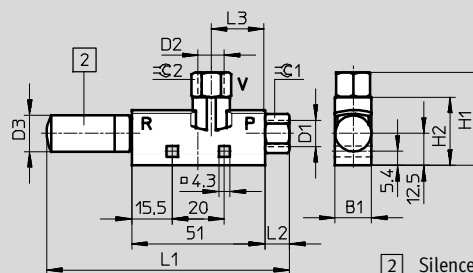

2 Silencer

Type	B1	Connections			H1	H2	L1	L2	L3	∅C1	∅C2		
		P D1	V D2	R D3									
VN-...-T2-PQ1-VQ1-RQ1	10	QS-4	QS-4	QS-4	31.3	27.7	58.2	3.6	24.3	-	-		
VN-...-T2-PQ1-VQ1-RO1				9.8 ¹⁾			86.8						
VN-...-T2-PI2-VI2-RI2		M5	M5	M5			61						
VN-...-T2-PI2-VI2-RO1				9.8 ¹⁾			88.2	5				9	9
VN-...-T3-PQ2-VQ2-RQ2	14	QS-6	QS-6	QS-6	30.4	26.2	59.4	4.2	25.5	-	-		
VN-...-T3-PQ2-VQ2-RO1				13.8 ¹⁾			97.6						
VN-...-T3-PQ2-VA4-RQ2				G ¹ / ₈			G ¹ / ₈					QS-6	59.4
VN-...-T3-PQ2-VA4-RO1		13.8 ¹⁾	97.6										
VN-...-T3-PI4-VI4-RI4		G ¹ / ₈	G ¹ / ₈	G ¹ / ₈			70	9.5				13	13
VN-...-T3-PI4-VI4-RO1				13.8 ¹⁾			102.9						
VN-...-T4-PQ2-VQ3-RQ3	18	QS-6	QS-8	QS-8	35.9	30.7	63.8	4.2	25.5	-	-		
VN-...-T4-PQ2-VQ3-RO2				17.8 ¹⁾			125.5						
VN-...-T4-PQ2-VA5-RQ3				G ¹ / ₄			G ¹ / ₄					QS-8	63.8
VN-...-T4-PQ2-VA5-RO2		17.8 ¹⁾	125.5										
VN-...-T4-PI4-VI5-RI5		G ¹ / ₈	G ¹ / ₈	G ¹ / ₄			81.4	9.5				13	17
VN-...-T4-PI4-VI5-RO2				17.8 ¹⁾			128.8						

1) ∅ Silencer

– Note: This product conforms to ISO 1179-1 and to ISO 228-1

Vacuum generators VN

Technical data

FESTO

Dimensions – T-type/Standard, VN-10

Download CAD data → www.festo.com

VN-10-L-T3-PI4-VA4-R01

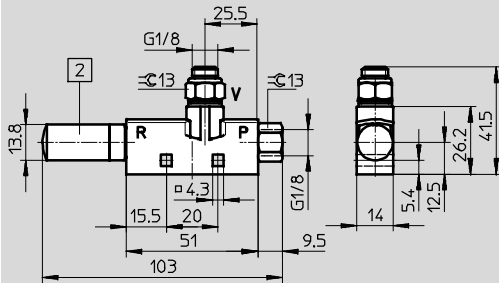

2 Silencer

Note: This product conforms to ISO 1179-1 and to ISO 228-1

Dimensions – T-type/Standard, VN-20/30

Download CAD data → www.festo.com

VN...-T6-PQ4-VQ5-R02

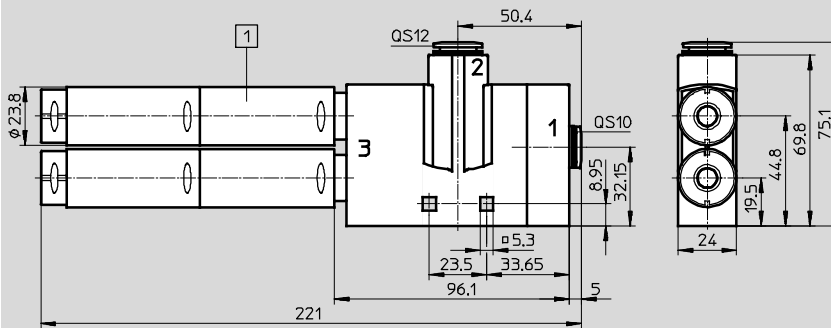

1 Silencer

VN...-T6-PQ4-VA5-R02

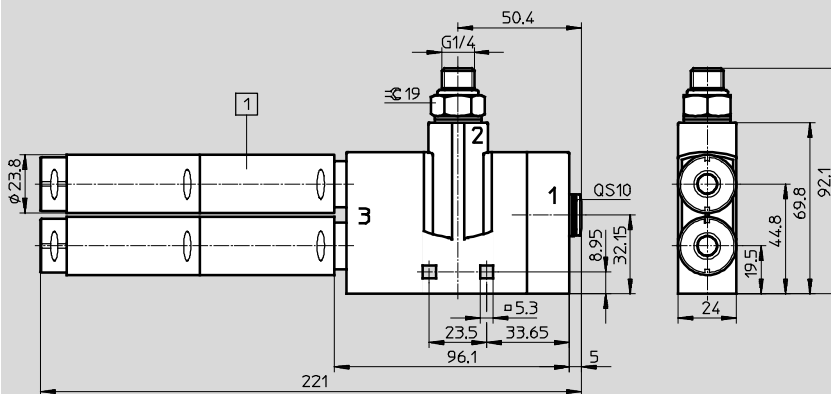

1 Silencer

Note: This product conforms to ISO 1179-1 and to ISO 228-1

VN...-T6-PI5-VI6-R02

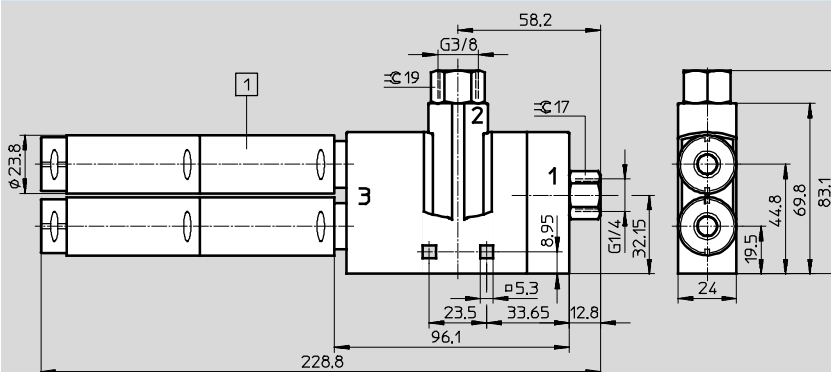

1 Silencer

Note: This product conforms to ISO 1179-1 and to ISO 228-1

Vacuum generators VN

Technical data

FESTO

Dimensions – T-type/Inline, VN-05/07

Download CAD data → www.festo.com

VN-...-T...-PQ...-VQ...-RQ...

VN-...-T...-PQ...-VQ...-R01

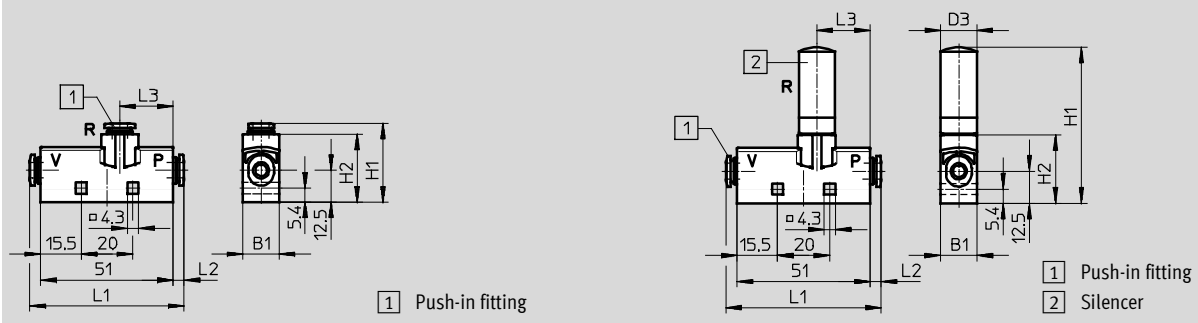

VN-...-T...-PI...-VI...-RI...

VN-...-T...-PI...-VI...-R01

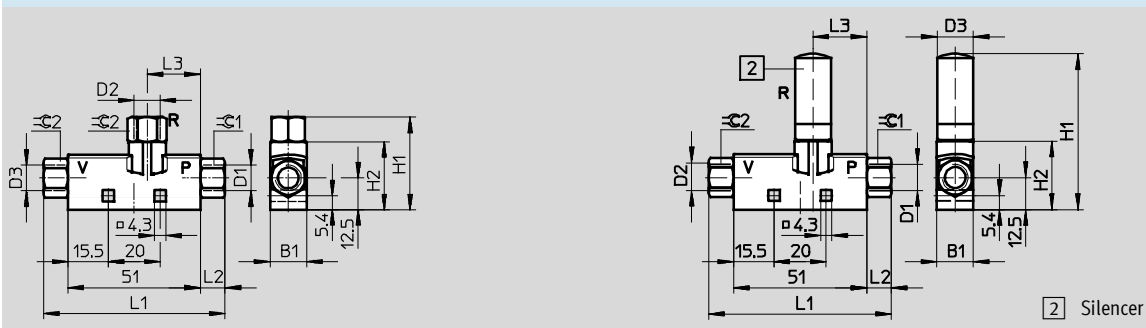

Type	B1	Connections			H1	H2	L1	L2	L3	∅1	∅2
		P D1	V D2	R D3							
VN-...-T2-PQ1-VQ1-RQ1	10	QS-4	QS-4	QS-4	31.3	27.7	58.2	3.6	24.3	-	-
VN-...-T2-PQ1-VQ1-R01				9.8 ¹⁾							
VN-...-T2-PI2-VI2-RI2		M5	M5	M5	32.7						
VN-...-T2-PI2-VI2-R01				9.8 ¹⁾	59.9						
VN-...-T3-PQ2-VQ2-RQ2	14	QS-6	QS-6	QS-6	30.4	26.2	59.4	4.2	25.5	-	-
VN-...-T3-PQ2-VQ2-R01				13.8 ¹⁾							
VN-...-T3-PI4-VI4-RI4		G ¹ / ₈	G ¹ / ₈	G ¹ / ₈	35.7						
VN-...-T3-PI4-VI4-R01				13.8 ¹⁾	68.6						

1) ∅ Silencer

Note: This product conforms to ISO 1179-1 and to ISO 228-1

Dimensions – Inline, VN-05/07/10

Download CAD data → www.festo.com

VN-05/07-...-I...-PQ...-VQ...

VN-10-M-I3-PQ2-VQ2

VN-05/07-...-I...-PQ...-VT...

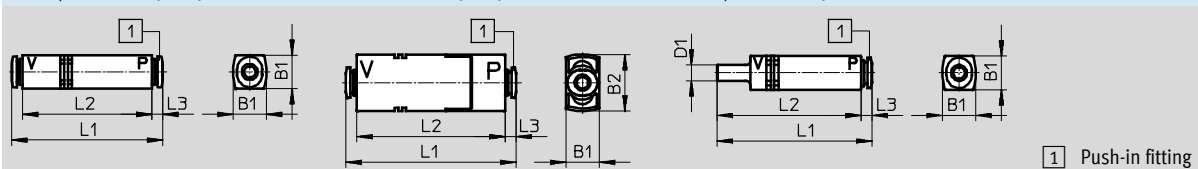

Type	B1	B2	Connections		D1 ∅	L1	L2	L3
			P	V				
VN-05/07-...-I2-PQ1-VQ1	10	-	QS-4	QS4	-	57.4	50.2	3.6
VN-05/07-...-I2-PQ1-VT1				-	4	61.6	58	
VN-05/07-...-I3-PQ2-VQ2	13	-	QS-6	QS6	-	58.6	50.2	4.2
VN-10-M-I3-PQ2-VQ2		22				66.1	57.7	
VN-05/07-...-I3-PQ2-VT2		-				60.2	56	

Vacuum generators VN

Technical data

FESTO

Ordering data and weights – Standard							
T-type							
Housing width [mm]	Nominal size of laval nozzle [mm]	Weight [g]	High vacuum H		Weight [g]	High suction rate L	
			Part No.	Type		Part No.	Type
With push-in fitting							
10	0.45	15	526 100	VN-05-H-T2-PQ1-VQ1-RQ1	15	526 114	VN-05-L-T2-PQ1-VQ1-RQ1
	0.7	15	526 101	VN-07-H-T2-PQ1-VQ1-RQ1	–	–	–
14	0.45	22	193 478	VN-05-H-T3-PQ2-VQ2-RQ2	22	193 561	VN-05-L-T3-PQ2-VQ2-RQ2
	0.7	22	193 479	VN-07-H-T3-PQ2-VQ2-RQ2	22	193 562	VN-07-L-T3-PQ2-VQ2-RQ2
	0.95	22	193 480	VN-10-H-T3-PQ2-VQ2-RQ2	22	193 563	VN-10-L-T3-PQ2-VQ2-RQ2
18	0.95	27	526 147	VN-10-H-T4-PQ2-VQ3-RQ3	27	526 157	VN-10-L-T4-PQ2-VQ3-RQ3
	1.4	27	193 482	VN-14-H-T4-PQ2-VQ3-RQ3	27	193 565	VN-14-L-T4-PQ2-VQ3-RQ3
With push-in fitting and silencer							
10	0.45	15	193 569	VN-05-H-T2-PQ1-VQ1-R01	15	193 595	VN-05-L-T2-PQ1-VQ1-R01
	0.7	15	193 570	VN-07-H-T2-PQ1-VQ1-R01	–	–	–
14	0.45	24	193 488	VN-05-H-T3-PQ2-VQ2-R01	24	193 571	VN-05-L-T3-PQ2-VQ2-R01
	0.7	24	193 489	VN-07-H-T3-PQ2-VQ2-R01	24	193 572	VN-07-L-T3-PQ2-VQ2-R01
	0.95	24	193 490	VN-10-H-T3-PQ2-VQ2-R01	24	193 573	VN-10-L-T3-PQ2-VQ2-R01
18	0.95	36	549 251	VN-10-H-T4-PQ2-VQ3-R02	36	549 253	VN-10-L-T4-PQ2-VQ3-R02
	1.4	36	547 707	VN-14-H-T4-PQ2-VQ3-R02	36	547 710	VN-14-L-T4-PQ2-VQ3-R02
24	2.0	182	193 495	VN-20-H-T6-PQ4-VQ5-R02	182	193 578	VN-20-L-T6-PQ4-VQ5-R02
	3.0	182	193 497	VN-30-H-T6-PQ4-VQ5-R02	–	–	–
With push-in fitting, vacuum connection with male thread							
14	0.45	24	193 516	VN-05-H-T3-PQ2-VA4-RQ2	24	193 599	VN-05-L-T3-PQ2-VA4-RQ2
	0.7	24	193 517	VN-07-H-T3-PQ2-VA4-RQ2	24	193 600	VN-07-L-T3-PQ2-VA4-RQ2
	0.95	24	193 518	VN-10-H-T3-PQ2-VA4-RQ2	24	193 601	VN-10-L-T3-PQ2-VA4-RQ2
18	0.95	33	526 153	VN-10-H-T4-PQ2-VA5-RQ3	33	526 163	VN-10-L-T4-PQ2-VA5-RQ3
	1.4	33	193 520	VN-14-H-T4-PQ2-VA5-RQ3	33	193 603	VN-14-L-T4-PQ2-VA5-RQ3
With push-in fitting, vacuum connection with male thread and silencer							
14	0.45	26	193 526	VN-05-H-T3-PQ2-VA4-R01	26	193 609	VN-05-L-T3-PQ2-VA4-R01
	0.7	26	193 527	VN-07-H-T3-PQ2-VA4-R01	26	193 610	VN-07-L-T3-PQ2-VA4-R01
	0.95	26	193 528	VN-10-H-T3-PQ2-VA4-R01	26	193 611	VN-10-L-T3-PQ2-VA4-R01
18	0.95	42	549 252	VN-10-H-T4-PQ2-VA5-R02	42	549 254	VN-10-L-T4-PQ2-VA5-R02
	1.4	42	547 706	VN-14-H-T4-PQ2-VA5-R02	42	547 709	VN-14-L-T4-PQ2-VA5-R02
24	2.0	189	526 145	VN-20-H-T6-PQ4-VA5-R02	189	526 135	VN-20-L-T6-PQ4-VA5-R02
	3.0	189	526 146	VN-30-H-T6-PQ4-VA5-R02	189	526 136	VN-30-L-T6-PQ4-VA5-R02

Vacuum generators VN

Technical data

FESTO

Ordering data and weights – Standard							
T-type							
Housing width [mm]	Nominal size of laval nozzle [mm]	Weight [g]	High vacuum H		Weight [g]	High suction rate L	
			Part No.	Type		Part No.	Type
With female thread							
10	0.45	13	526 102	VN-05-H-T2-PI2-VI2-RI2	13	526 116	VN-05-L-T2-PI2-VI2-RI2
	0.7	13	526 103	VN-07-H-T2-PI2-VI2-RI2	–	–	–
14	0.45	22	193 498	VN-05-H-T3-PI4-VI4-RI4	22	193 581	VN-05-L-T3-PI4-VI4-RI4
	0.7	22	193 499	VN-07-H-T3-PI4-VI4-RI4	22	193 582	VN-07-L-T3-PI4-VI4-RI4
	0.95	22	193 500	VN-10-H-T3-PI4-VI4-RI4	22	193 583	VN-10-L-T3-PI4-VI4-RI4
18	1.4	36	193 502	VN-14-H-T4-PI4-VI5-RI5	36	193 585	VN-14-L-T4-PI4-VI5-RI5
With female thread and silencer							
10	0.45	13	526 104	VN-05-H-T2-PI2-VI2-RO1	13	526 118	VN-05-L-T2-PI2-VI2-RO1
	0.7	13	526 105	VN-07-H-T2-PI2-VI2-RO1	–	–	–
14	0.45	24	193 507	VN-05-H-T3-PI4-VI4-RO1	24	193 590	VN-05-L-T3-PI4-VI4-RO1
	0.7	24	193 508	VN-07-H-T3-PI4-VI4-RO1	24	193 591	VN-07-L-T3-PI4-VI4-RO1
	0.95	24	193 509	VN-10-H-T3-PI4-VI4-RO1	24	193 592	VN-10-L-T3-PI4-VI4-RO1
18	1.4	40	547 705	VN-14-H-T4-PI4-VI5-RO2	40	547 708	VN-14-L-T4-PI4-VI5-RO2
24	2.0	183	526 141	VN-20-H-T6-PI5-VI6-RO2	183	526 131	VN-20-L-T6-PI5-VI6-RO2
	3.0	183	526 142	VN-30-H-T6-PI5-VI6-RO2	183	526 132	VN-30-L-T6-PI5-VI6-RO2
With female thread, vacuum connection with male thread and silencer							
14	0.95	–	–	–	26	543 315	VN-10-L-T3-PI4-VA4-RO1

Ordering data and weights – Inline							
T-type							
Housing width [mm]	Nominal size of laval nozzle [mm]	Weight [g]	High vacuum M		Weight [g]	High suction rate N	
			Part No.	Type		Part No.	Type
With push-in fitting							
10	0.45	15	526 106	VN-05-M-T2-PQ1-VQ1-RQ1	–	–	–
	0.7	15	526 107	VN-07-M-T2-PQ1-VQ1-RQ1	–	–	–
14	0.45	22	193 536	VN-05-M-T3-PQ2-VQ2-RQ2	22	193 619	VN-05-N-T3-PQ2-VQ2-RQ2
	0.7	22	193 537	VN-07-M-T3-PQ2-VQ2-RQ2	–	–	–
With push-in fitting and silencer							
10	0.45	15	526 108	VN-05-M-T2-PQ1-VQ1-RO1	–	–	–
	0.7	15	526 109	VN-07-M-T2-PQ1-VQ1-RO1	–	–	–
14	0.45	24	193 540	VN-05-M-T3-PQ2-VQ2-RO1	24	193 623	VN-05-N-T3-PQ2-VQ2-RO1
	0.7	24	193 541	VN-07-M-T3-PQ2-VQ2-RO1	–	–	–
With female thread							
10	0.45	13	526 110	VN-05-M-T2-PI2-VI2-RI2	–	–	–
	0.7	13	526 111	VN-07-M-T2-PI2-VI2-RI2	–	–	–
14	0.45	22	193 544	VN-05-M-T3-PI4-VI4-RI4	22	193 627	VN-05-N-T3-PI4-VI4-RI4
	0.7	22	193 545	VN-07-M-T3-PI4-VI4-RI4	–	–	–
With female thread and silencer							
10	0.45	13	526 112	VN-05-M-T2-PI2-VI2-RO1	–	–	–
	0.7	13	526 113	VN-07-M-T2-PI2-VI2-RO1	–	–	–
14	0.45	24	193 548	VN-05-M-T3-PI4-VI4-RO1	24	193 631	VN-05-N-T3-PI4-VI4-RO1
	0.7	24	193 549	VN-07-M-T3-PI4-VI4-RO1	–	–	–

Vacuum generators VN

Technical data

Ordering data and weights – Inline							
Inline							
Housing width [mm]	Nominal size of laval nozzle [mm]	Weight [g]	High vacuum M		Weight [g]	High suction rate N	
			Part No.	Type		Part No.	Type
With push-in fitting							
10	0.45	11	193 580	VN-05-M-I2-PQ1-VQ1	-	-	-
	0.7	11	193 586	VN-07-M-I2-PQ1-VQ1			
13	0.45	16	193 552	VN-05-M-I3-PQ2-VQ2	16	193 635	VN-05-N-I3-PQ2-VQ2
	0.7	16	193 553	VN-07-M-I3-PQ2-VQ2			
	0.95	23	193 554	VN-10-M-I3-PQ2-VQ2			
With push-in fitting and push-in sleeve							
10	0.45	8	193 587	VN-05-M-I2-PQ1-VT1	-	-	-
	0.7	8	193 588	VN-07-M-I2-PQ1-VT1			
13	0.45	12	193 555	VN-05-M-I3-PQ2-VT2	12	193 637	VN-05-N-I3-PQ2-VT2
	0.7	12	193 556	VN-07-M-I3-PQ2-VT2			

Vacuum generators VN-P, with integrated vacuum switch

Peripherals overview and type codes

Peripherals overview

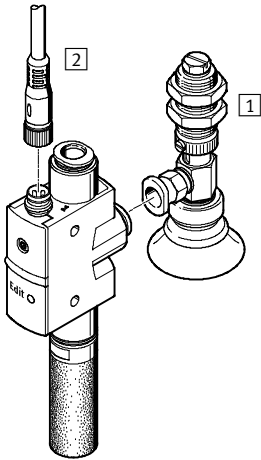

Mounting attachments and accessories	→ Page/Internet
1 Suction gripper ESG	esg
2 Plug socket with cable, 3-pin NEBU-M8	nebu-m8*3
- Suction cup holder ESH	esh
- Suction cup ESS	ess

Type codes

VN – 05 – H – T4 – PQ2 – VQ2 – O2 – P

Type

VN	Vacuum generator
----	------------------

Nominal size of laval nozzle [mm]

05	0.45
07	0.7
10	0.95

Ejector characteristic

H	High vacuum/Standard
L	High suction rate/Standard

Housing type

T4	T-type, grid dimensions 16 mm
----	-------------------------------

Pneumatic connection 1

PQ2	Push-in fitting QS-6
-----	----------------------

Vacuum connection

VQ2	Push-in fitting QS-6
-----	----------------------

Switching function

O1	Threshold value with fixed hysteresis, 2 teach-in points, NO contact
O2	Threshold value with variable hysteresis, NO contact

Electrical output



P	Switch output PNP
---	-------------------

Vacuum generators VN-P, with integrated vacuum switch

Technical data

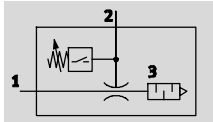
Function
VN Standard



-  - Temperature range
0 ... +60 °C
-  - Operating pressure
1 ... 8 bar



- Threshold value comparator with fixed or variable hysteresis
- Teach-in setting option for threshold value and hysteresis

General technical data			
Design	T-type		
Type	VN-05	VN-07	VN-10
Grid dimension [mm]	16	16	16
Nominal size of laval nozzle [mm]	0.45	0.7	0.95
Ejector characteristic	High vacuum/Standard H High suction rate/Standard L		
Pneumatic connection 1	QS-6		
Vacuum connection	QS-6		
Pneumatic connection 3	Silencer, minimal resistance		
Measured variable	Relative pressure		
Measuring principle	Piezoresistive		
Pressure measuring range [bar]	-1 ... 0		
Type of mounting (max. tightening torque)	Via through-holes (0.6 Nm)		
Assembly position	Any ¹⁾		
Cleaning recommendation	Soap suds		
Product weight [g]	33	36	36

1) The collection of condensate in the sensor should be prevented.

Operating and environmental conditions	
Operating pressure [bar]	1 ... 8
Nominal operating pressure [bar]	6
Operating medium	Compressed air in accordance with ISO 8573-1:2010 [7:4:4]
Note on operating/pilot medium	Operation with lubricated medium not possible
Ambient temperature [°C]	0 ... +50
Temperature of medium [°C]	0 ... +60
Corrosion resistance class CRC ¹⁾	1
CE mark (see declaration of conformity)	To EU EMC Directive ²⁾
Certification	C-Tick

1) Corrosion resistance class 1 according to Festo standard 940 070
Components requiring low corrosion resistance. Transport and storage protection. Parts that do not have primarily decorative surface requirements, e.g. in internal areas that are not visible or behind covers.

2) For information about the applicability of the component see the manufacturer's EC declaration of conformity at: www.festo.com → Support → User documentation.
If the component is subject to restrictions on usage in residential, office or commercial environments or small businesses, further measures to reduce the emitted interference may be necessary.

Vacuum generators VN-P, with integrated vacuum switch

FESTO

Technical data

Performance data							
Ejector characteristic		High vacuum/Standard H			High suction rate/Standard L		
Nominal size of laval nozzle	[mm]	0.45	0.7	0.95	0.45	0.7	0.95
Max. vacuum	[%]	92	92	93	–	–	–
Operating pressure for max. vacuum	[bar]	4.9	4.4	3.5	–	–	–
Max. suction rate with respect to atmosphere	[l/min]	7.2	16.2	21.8	13.6	30.9	41.5
Operating pressure for max. suction rate	[bar]	3	3	3	5	4	5
Noise level at nominal operating pressure 6 bar	[dB (A)]	62	66	70	54	63	66

Electrical data	
Operating voltage range	[V DC] 15 ... 30
Residual ripple	[%] 10
Electrical connection	M8x1, 3-pin
Switch-on/switch-off times	[ms] ≤ 4
Switch output	PNP
Max. output current	[mA] 100
Residual current	[mA] ≤ 0.3
Voltage drop	[V] ≤ 1.5
Switching element function	NO contact
Setting options	Teach-In
Switching function	Threshold value comparator with fixed hysteresis Threshold value comparator with variable hysteresis
Threshold value setting range	[bar] –1 ... 0
Accuracy	[% FS] ¹⁾ ±1.5
Hysteresis	[% FS] ¹⁾ ±2 (threshold value comparator with fixed hysteresis)
Long-term drift	[% FS] ¹⁾ Max. ±0.5
Temperature coefficient of switching point	[%/K] 0.05
Type of display/switching status display	LED
Inductive protective circuit	Adapted to MZ, MY, ME coils
Protection against short circuit	Pulsed
Protection against polarity reversal	For all electrical connections
Protection against overloading	Yes
Protection class	IP40 (to EN 60 529)

1) % FS = % of the measuring range final value (full scale)

Electrical outputs ¹⁾	Pin allocations
1 switch output PNP	

Plug M8x1

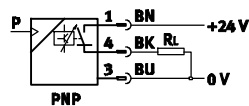

1 = +24 V
3 = 0 V
4 = Output A



1) Core colours indicated apply when using plug sockets with cable NEBU-M8, 3-pin. Technical data → Internet: nebu-m8*3

Vacuum generators VN-P, with integrated vacuum switch

Technical data

Materials

General view

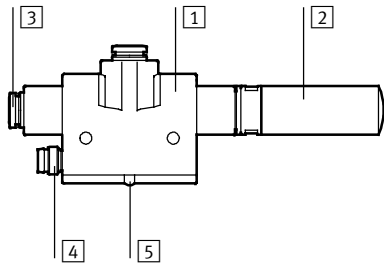

Vacuum generator		
1	Housing	POM-reinforced
2	Silencer	PE
3	Push-in fitting	Nickel plated brass
4	Plug housing	PA, nickel and chrome plated brass
5	Fibre optics	PC
-	Jet nozzle	Wrought aluminium alloy
-	Receiver nozzle	POM
-	Key pad	POM
-	Seals	NBR

Vacuum p_u as a function of operating pressure p_1

High vacuum/high suction rate

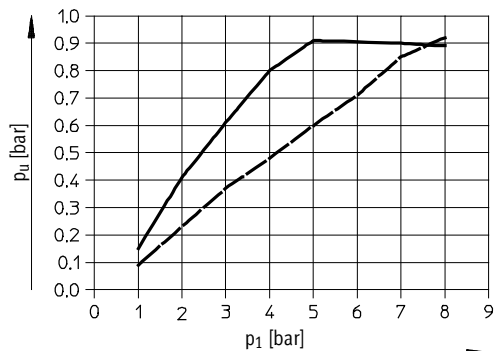

— VN-05-H
- - - VN-05-L

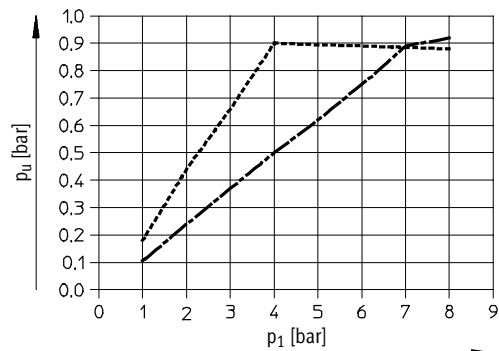

..... VN-07-H
- - - VN-07-L

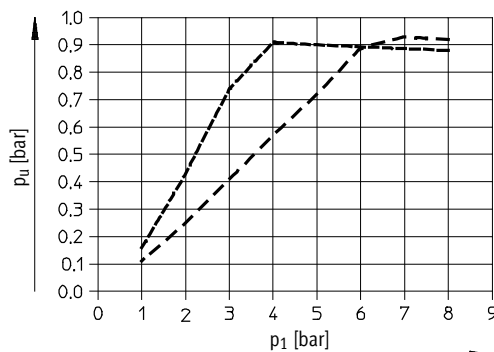

..... VN-10-H
- - - VN-10-L

Vacuum generators VN-P, with integrated vacuum switch

Technical data

Evacuation time t as a function of vacuum p_u for 1 l volume at 6 bar operating pressure

High vacuum/high suction rate

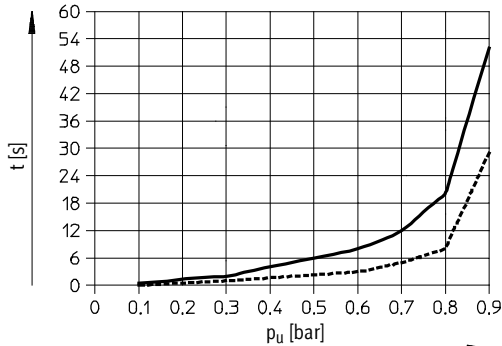

— VN-05-H
- - - VN-07-H

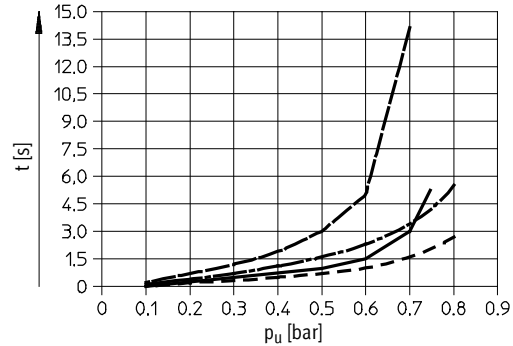

— VN-05-L — VN-10-H
- - - VN-07-L - - - VN-10-L

Suction rate q_{ns} (with respect to atmosphere) as a function of operating pressure p_1

High vacuum/high suction rate

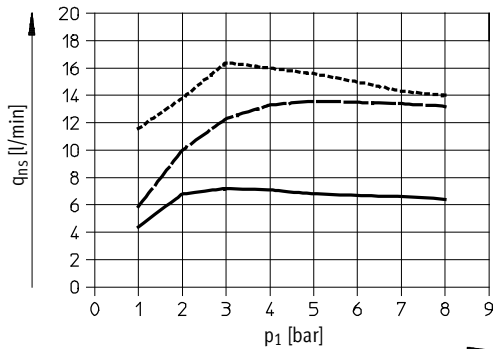

— VN-05-H
- - - VN-05-L
- - - VN-07-H

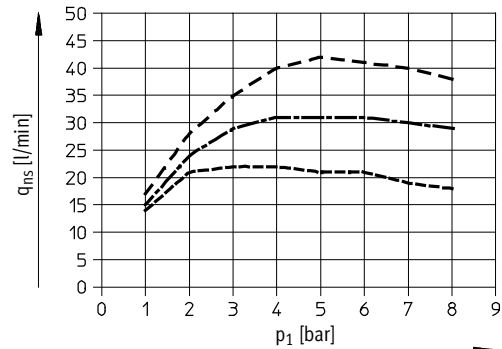

— VN-07-L
- - - VN-10-H
- - - VN-10-L

Air consumption q_n as a function of operating pressure p_1

High vacuum/high suction rate

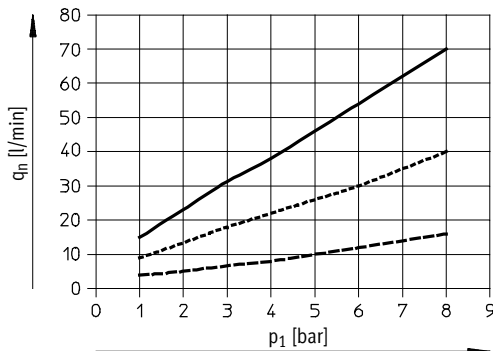

— VN-05
- - - VN-07
— VN-10

Vacuum generators VN-P, with integrated vacuum switch

Technical data

FESTO

Dimensions

Download CAD data → www.festo.com

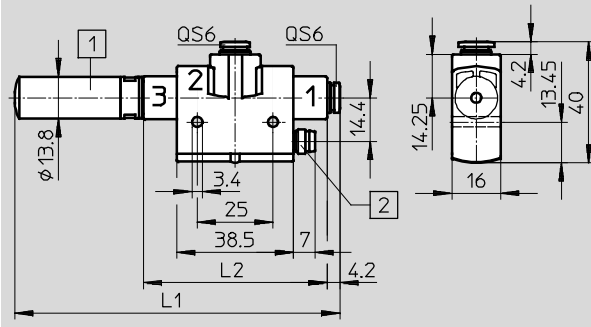

- 1 Silencer
- 2 Plug, M8x1, 3-pin

Type	L1	L2
VN-05	93.6	44.2
VN-07	107	60.5
VN-10		

Ordering data

with push-in fitting and silencer

Nominal size of laval nozzle [mm]	Switching function		High vacuum/Standard H		High suction rate/Standard L	
	Threshold value with fixed hysteresis	Threshold value with variable hysteresis	Part No.	Type	Part No.	Type
0.45	■	–	536796	VN-05-H-T4-PQ2-VQ2-01-P	536798	VN-05-L-T4-PQ2-VQ2-01-P
	–	■	536797	VN-05-H-T4-PQ2-VQ2-02-P	536799	VN-05-L-T4-PQ2-VQ2-02-P
0.7	■	–	536800	VN-07-H-T4-PQ2-VQ2-01-P	536802	VN-07-L-T4-PQ2-VQ2-01-P
	–	■	536801	VN-07-H-T4-PQ2-VQ2-02-P	536803	VN-07-L-T4-PQ2-VQ2-02-P
0.95	■	–	536804	VN-10-H-T4-PQ2-VQ2-01-P	536806	VN-10-L-T4-PQ2-VQ2-01-P
	–	■	536805	VN-10-H-T4-PQ2-VQ2-02-P	536807	VN-10-L-T4-PQ2-VQ2-02-P

Vacuum generators VN-A/M/B, with additional functions

Peripherals overview

Inline VN-05/07-...-A	T-type VN-05/07/10/14-...-A/M/B	VN-20/30-...-M
--------------------------	------------------------------------	----------------

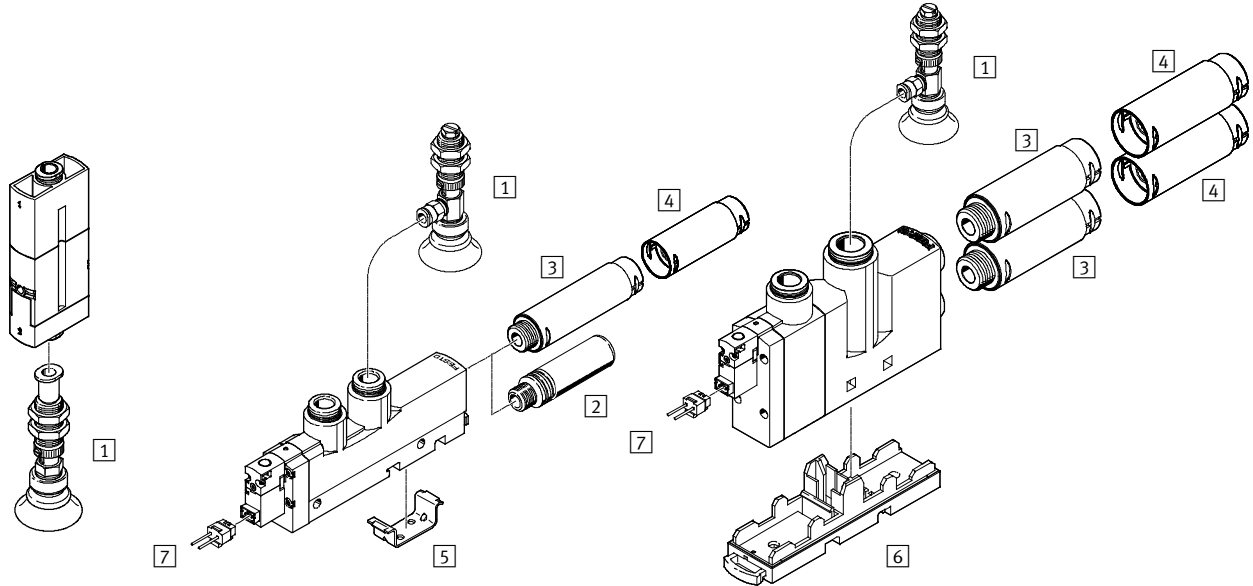

Mounting attachments and accessories									
	Inline	T-type						→ Page/Internet	
	VN-05/07	VN-05/07/10			VN-14				VN-20/30
	A	A	M	B	A	M	B		M
1 Suction gripper ESG	■	■			■			■	esg
2 Silencer UO	-	■			-			-	uo
3 Silencer UOM	-	-			■			■	uom
4 Silencer extension UOMS	-	-			■			■	uoms
5 Mounting bracket VN-T3/T4	-	■			■			-	vn-t
6 Mounting plate VN-T6-BP-NRH	-	-			-			■	vn-t
7 Plug socket with cable, 2-pin KMH	-	-	■	■	-	■	■	■	kmh
- Suction cup holder ESH	■	■			■			■	esh
- Suction cup ESS	■	■			■			■	ess

Vacuum generators VN-A/M/B, with additional functions

Type codes

VN – 05 – H – T3 – PQ2 – VQ2 – RO1 – M

Type

VN	Vacuum generator
----	------------------

Nominal size of laval nozzle [mm]

05	0.45
07	0.7
10	0.95
14	1.4
20	2.0
30	3.0

Ejector characteristic

H	High vacuum/Standard T-type
L	High suction rate/Standard T-type
M	High vacuum/Inline
N	High suction rate/Inline

Housing type

I3	Inline, grid dimension 14.5 mm
T3	T-type, grid dimension 14 mm
T4	T-type, grid dimension 18 mm
T6	T-type, grid dimension 24 mm

Pneumatic connection 1

PQ2	Push-in fitting QS-6
PQ3	Push-in fitting QS-8
PQ4	Push-in fitting QS-10
PI4	Female thread G $\frac{1}{8}$
PI5	Female thread G $\frac{1}{4}$

Vacuum connection

VQ2	Push-in fitting QS-6
VQ3	Push-in fitting QS-8
VQ5	Push-in fitting QS-12
VI4	Female thread G $\frac{1}{8}$
VI5	Female thread G $\frac{1}{4}$

Pneumatic connection 3

RO1	Silencer UO, minimal resistance
RO2	Silencer UOM, minimal resistance

Integrated function

A	Pneumatic ejector pulse
M	Electrical on-off valve
B	Electrical on-off valve and pneumatic ejector pulse



Note

Possible combinations can be found in the ordering data.

Vacuum generators VN-A/M/B, with additional functions



FESTO

Technical data

Function

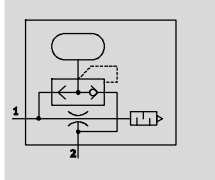
VN-A – Standard/Inline
Pneumatic ejector pulse



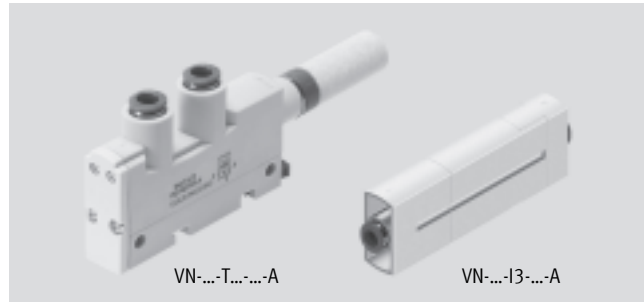

- VN-A
-  - Temperature range
0 ... +60 °C
 -  - Operating pressure
1 ... 8 bar

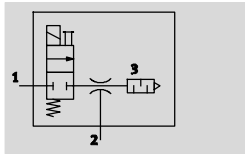

VN-M – Standard
Electrical on-off valve



- VN-M / VN-B
-  - Temperature range
0 ... +50 °C
 -  - Operating pressure
2 ... 8 bar

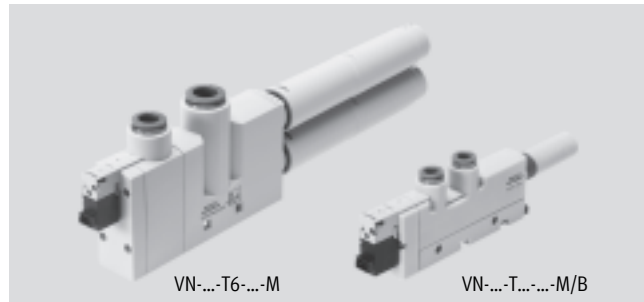

VN-B – Standard
Electrical on-off valve,
pneumatic ejector pulse

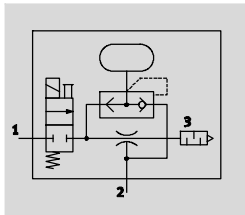

General technical data – Standard																	
Constructional design		T-type															
Type	VN-05			VN-07			VN-10			VN-14			VN-20		VN-30		
Grid dimension	[mm]																
Integrated function	A	M	B	A	M	B	A	M	B	A	M	B	M	M			
Nominal size of laval nozzle	[mm]																
Ejector characteristic		High vacuum/Standard H (T-type)												High suction rate/Standard L (T-type)		–	
Pneumatic connection 1	Push-in fitting	QS-6	QS-6	QS-6	QS-6	QS-6	QS-6	QS-6	QS-6	QS-6	QS-6	QS-6	QS-6	QS-6	QS-6		
	Female thread	G1/8	–	–	G1/8	–	–	G1/8	–	–	G1/4	–	–	–	–		
Vacuum connection	Push-in fitting	QS-6	QS-6	QS-6	QS-6	QS-6	QS-6	QS-6	QS-6	QS-6	QS-6	QS-6	QS-6	QS-6	QS-6		
	Female thread	G1/8	–	–	G1/8	–	–	G1/8	–	–	G1/4	–	–	–	–		
Pneumatic connection 3		Silencer, minimal resistance															
Type of mounting (max. tightening torque)		Via through-holes (0.5 Nm)												Via through-holes (0.8 Nm)			
		Via H-rail												–			
		Via accessories															
Mounting position		Any															
Cleaning recommendation		Soapy water															

- | - Note: This product conforms to ISO 1179-1 and to ISO 228-1

Vacuum generators VN-A/M/B, with additional functions

Technical data

General technical data – Inline		
Constructional design	Inline	
Type	VN-05	VN-07
Grid dimension [mm]	14.5	14.5
Integrated function	A	
Nominal size of laval nozzle [mm]	0.45	0.7
Ejector characteristic	High vacuum/Inline M High suction rate/Inline N	
Pneumatic connection 1	QS-6	
Vacuum connection	QS-6	
Type of mounting	Inline installation	
Mounting position	Any	
Cleaning recommendation	Soapy water	

Operating and environmental conditions				
Pneumatic connection	Via push-in fitting			Via female threads
Integrated function	A	M	B	A
Operating pressure [bar]	1 ... 8	2 ... 8		1 ... 8
Nominal operating pressure [bar]	6			
Operating medium	Compressed air in accordance with ISO 8573-1:2010 [7:4:4]			
Note on operating/pilot medium	Operation with lubricated medium not possible			
Ambient temperature [°C]	0 ... +60	0 ... +50		0 ... +60
Temperature of medium [°C]	0 ... +60	0 ... +50		0 ... +60
Corrosion resistance class CRC ¹⁾	1			2

1) Corrosion resistance class 1 to Festo standard 940 070
 Components requiring low corrosion resistance. Transport and storage protection. Parts that do not have primarily decorative surface requirements, e.g. in internal areas that are not visible or behind covers.
 Corrosion resistance class 2 to Festo standard 940 070
 Components subject to moderate corrosion stress. Externally visible parts with primarily decorative surface requirements which are in direct contact with a normal industrial environment or media such as coolants or lubricating agents.

Performance data – High vacuum																	
Ejector characteristic	Standard H															Inline M	
	0.45			0.7			0.95			1.4			2.0	3.0	0.45	0.7	
Nominal size of laval nozzle [mm]	A	M	B	A	M	B	A	M	B	A	M	B	M	M	A	A	
Max. vacuum [%]	92			92			93			92			92	93	93	93	
Operating pressure for max. vacuum [bar]	4.9			4.4			3.5			3.5			3.5	3.7	4.3	4.3	
Max. suction rate with respect to atmosphere [l/min]	7.2			16.2			21.8			48.8			98	186	7.2	16.6	
Operating pressure for max. suction rate [bar]	3			3			3			2			2	2	2	2	
Air supply time at nominal operating pressure 6 bar (for 1 l volume) [s]	3.63	3.9		1.5	1.69		0.96	1.06		0.43	0.5		0.24	0.13	4.1	1.69	
Noise level at nominal operating pressure 6 bar [dB (A)]	56			65			71			69			63	78	66	75	

Vacuum generators VN-A/M/B, with additional functions

FESTO

Technical data

Performance data – High suction rate															
Ejector characteristic	Standard L										Inline N				
Nominal size of laval nozzle [mm]	0.45			0.7			0.95			1.4		0.45	0.7		
Integrated function	A	M	B	A	M	B	A	M	B	A	M	B	A	A	
Max. suction rate with respect to atmosphere [l/min]	13.6			30.9			40.5			92.6		13.3	32.6		
Operating pressure for max. suction rate [bar]	5			4			5			5		5	4		
Air supply time at nominal operating pressure 6 bar (for 1 l volume) [s]	1.93	1.97		0.79	0.83		0.62	0.67		0.28	0.32		2.24	0.89	
Noise level at nominal operating pressure 6 bar [dB (A)]	52			64			72			69		68	78		

Technical data – Solenoid valve	
Operating voltage range [V DC]	21.6 ... 26.4
Duty cycle [%]	100
Protection class	IP40 (to EN 60 529)
Valve function	2/2-way valve
Manual override	By pushing

Materials

Sectional view

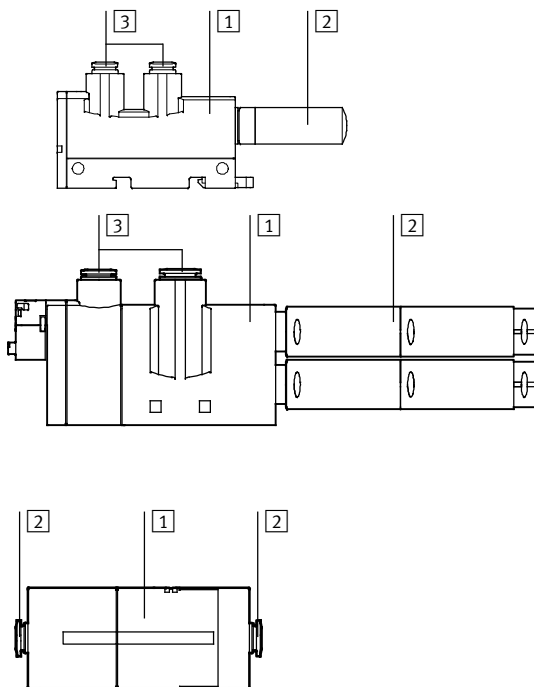

Vacuum generator VN – Standard	
1 Housing	PA-reinforced, POM-reinforced
2 Silencer	RO1 PE
	RO2 Wrought aluminium alloy, POM, PU foam
3 Push-in fitting	Nickel plated brass
– Connecting thread	Anodised wrought aluminium alloy
– Jet nozzle	Wrought aluminium alloy
– Receiver nozzle	POM
– Screws	Steel
– Seals	NBR
Note on materials	– Free of copper and PTFE
	RO2 Contains paint-wetting impairment substances

Vacuum generator VN – Inline	
1 Housing	PA-reinforced, POM-reinforced
2 Push-in fitting	Nickel plated brass
– Jet nozzle	Wrought aluminium alloy
– Receiver nozzle	POM
– Seals	NBR
Note on materials	Free of copper and PTFE

Vacuum generators VN-A/M/B, with additional functions

Technical data

Vacuum p_u as a function of operating pressure p_1

High vacuum – Standard

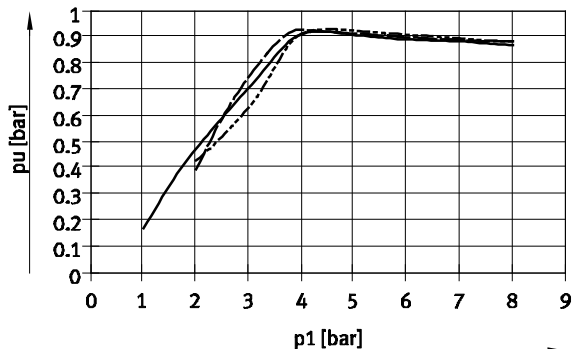

- VN-05-H
- - - VN-07-H
- · - VN-10-H

High suction rate – Standard

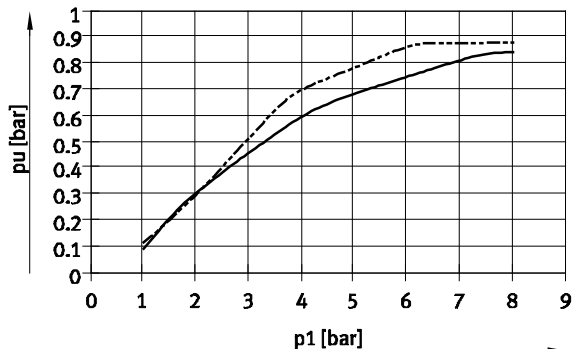

- VN-05-L
- - - VN-10-L

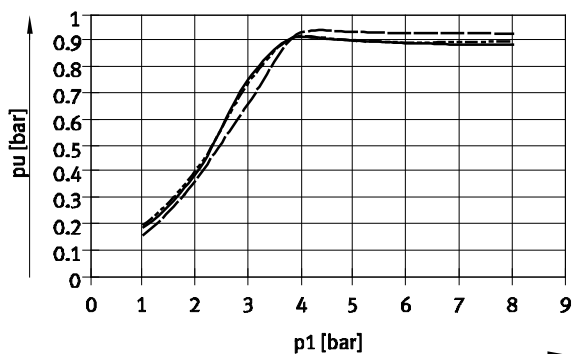

- VN-14-H
- - - VN-20-H
- · - VN-30-H

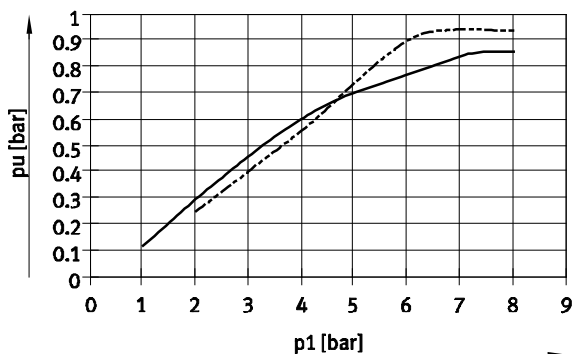

- VN-07-L
- - - VN-14-L

High vacuum – Inline

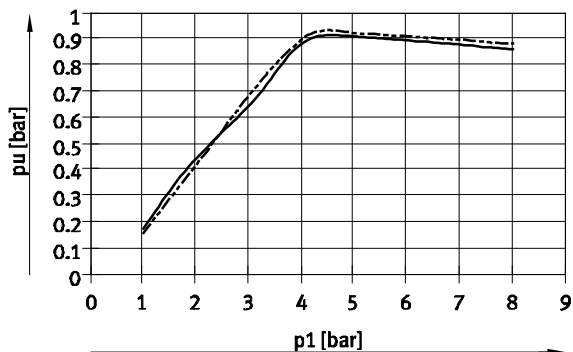

- VN-05-M
- - - VN-07-M

High suction rate – Inline

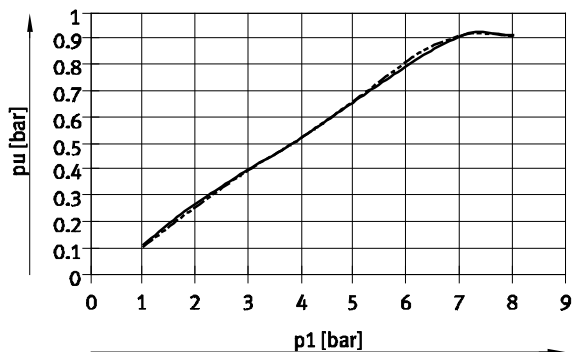

- VN-05-N
- - - VN-07-N

Vacuum generators VN-A/M/B, with additional functions

Technical data

Evacuation time t as a function of vacuum p_u for 1 l volume at 6 bar operating pressure

High vacuum – Standard

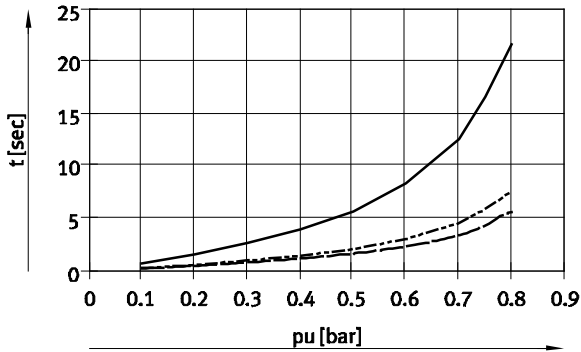

— VN-05-H
 - - - VN-07-H
 - · - VN-10-H

High suction rate – Standard

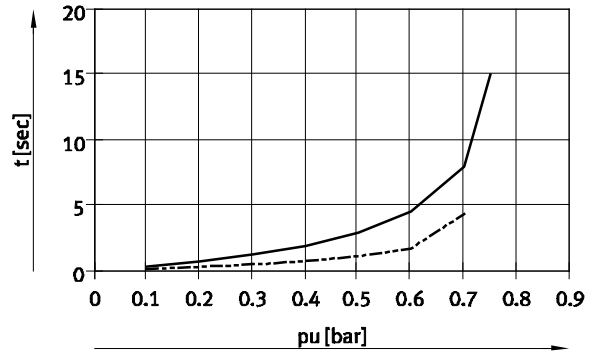

— VN-05-L
 - - - VN-07-L

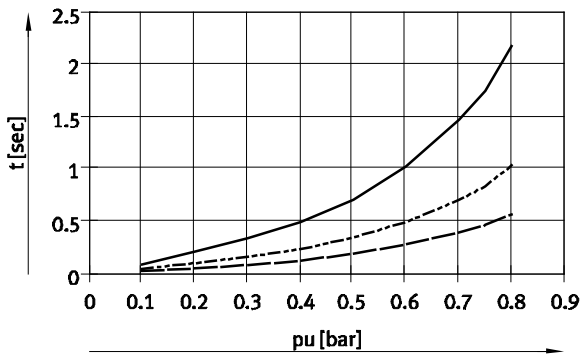

— VN-14-H
 - - - VN-20-H
 - · - VN-30-H

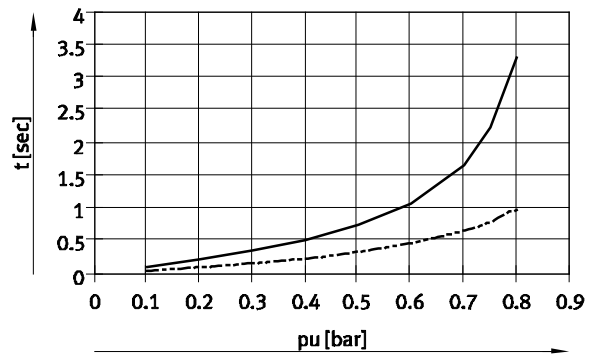

— VN-10-L
 - - - VN-14-L

High vacuum – In-line

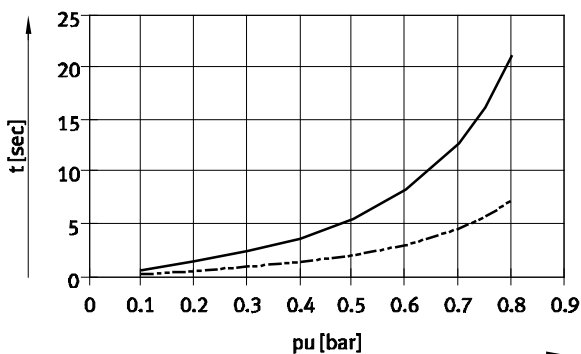

— VN-05-M
 - - - VN-07-M

High suction rate – In-line

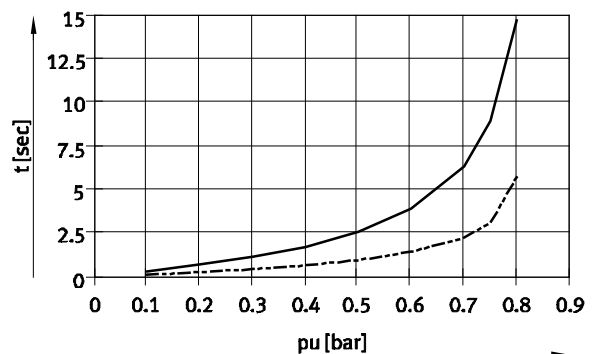

— VN-05-N
 - - - VN-07-N

Vacuum generators VN-A/M/B, with additional functions

Technical data

Suction rate q_{ns} (with respect to atmosphere) as a function of operating pressure p_1

High vacuum – Standard

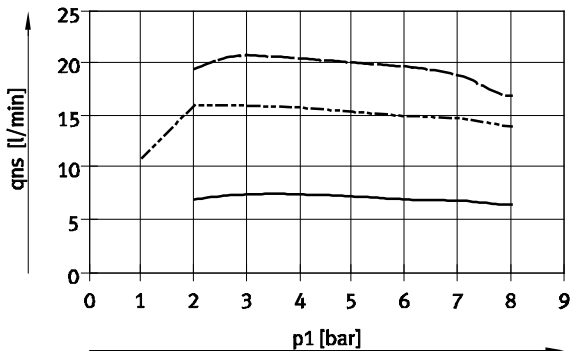

— VN-05-H
 - - - VN-07-H
 - · - VN-10-H

High suction rate – Standard

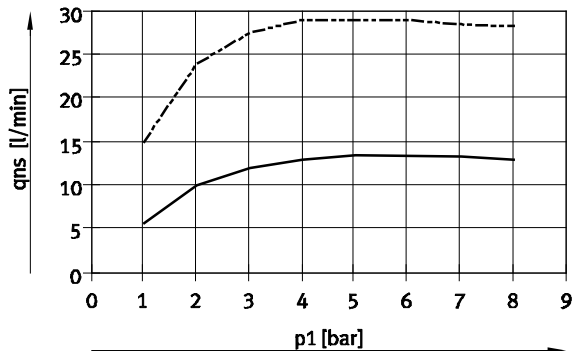

— VN-05-L
 - - - VN-07-L

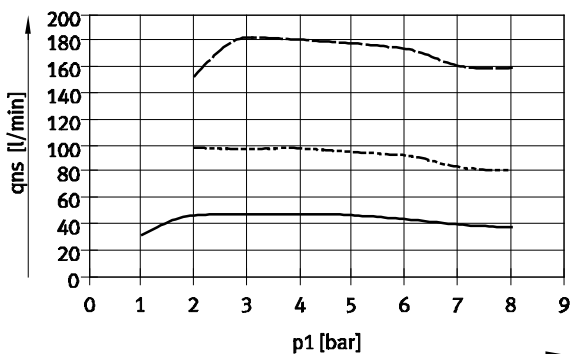

— VN-14-H
 - - - VN-20-H
 - · - VN-30-H

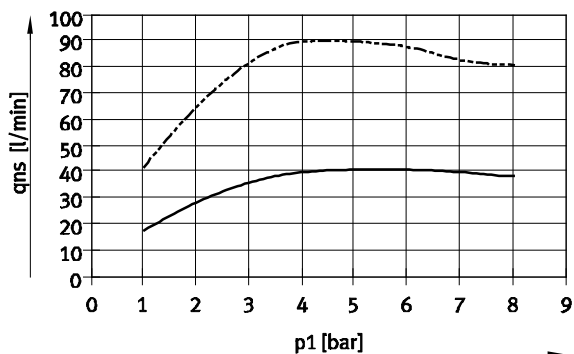

— VN-10-L
 - - - VN-14-L

High vacuum – Inline

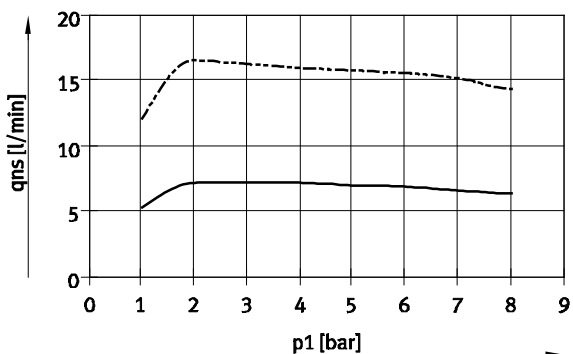

— VN-05-M
 - - - VN-07-M

High suction rate – Inline

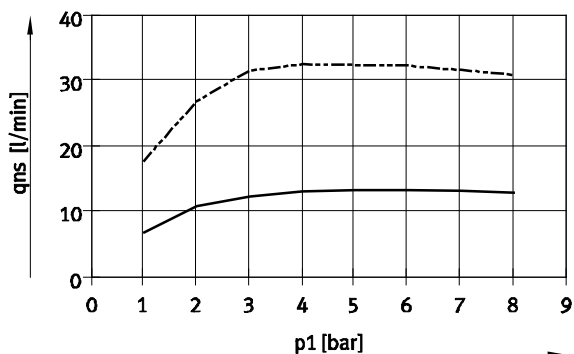

— VN-05-N
 - - - VN-07-N

Vacuum generators VN-A/M/B, with additional functions

Technical data

Air consumption q_n as a function of operating pressure p_1

High vacuum/high suction rate

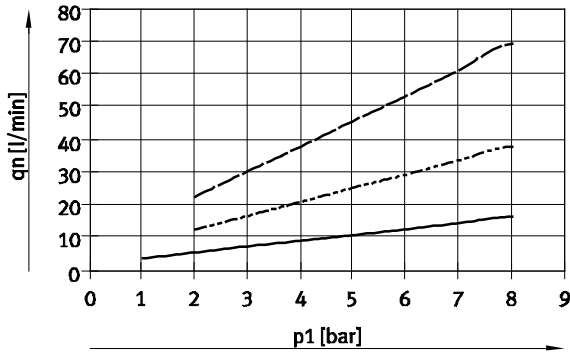

— VN-05
 VN-07
 - - - - - VN-10

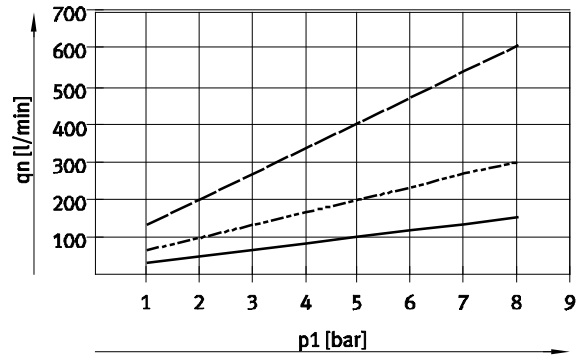

— VN-14
 VN-20
 - - - - - VN-30

Dimensions – T-type/Standard, VN-05/07/10/14

Download CAD data → www.festo.com

VN-...-T...-PQ...-VQ...-RO...-A

VN-...-T...-PI...-VI...-RO...-A

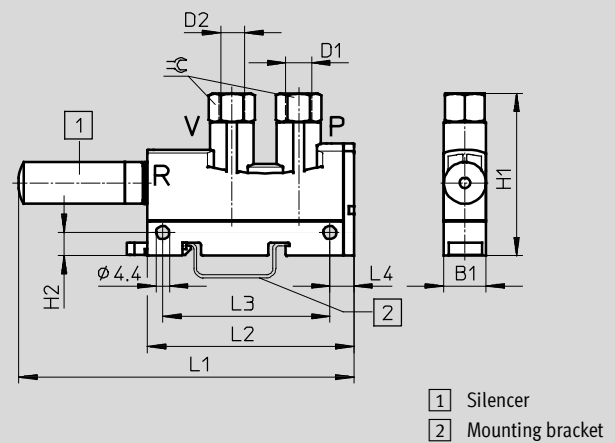
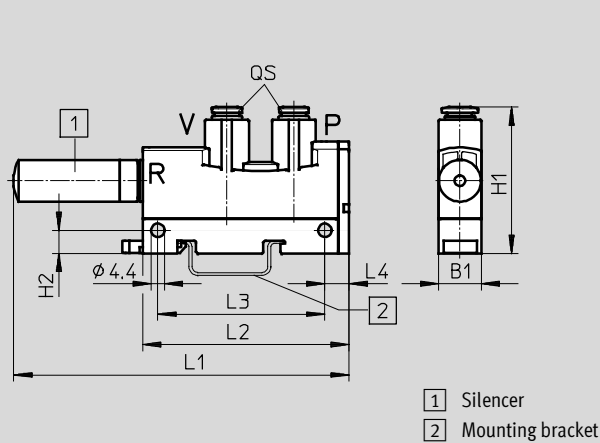

VN-...-T...-PQ...-VQ...-RO...-M/B

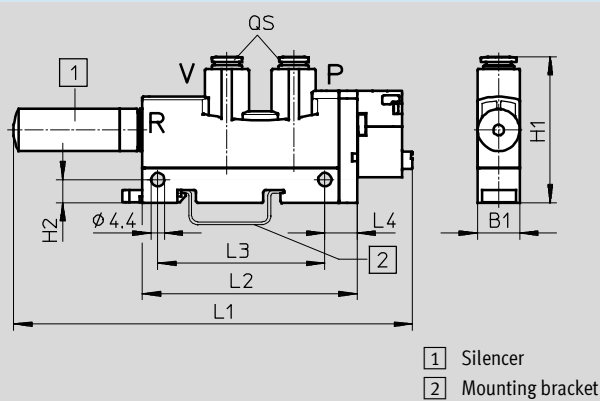

Vacuum generators VN-A/M/B, with additional functions

Technical data

Type	B1	Connections		H1	H2	L1	L2	L3	L4	⌀
		P D1	V D2							
VN-05-...-T3-PQ2-VQ2-R01-A	14	QS-6	QS-6	48	7.6	110	68	55	8	-
VN-07-...-T3-PQ2-VQ2-R01-A						119				
VN-10-...-T3-PQ2-VQ2-R01-A						110				
VN-05-...-T3-PI4-VI4-R01-A		G1/8	G1/8	53		119				
VN-07-...-T3-PI4-VI4-R01-A						VN-10-...-T3-PI4-VI4-R01-A				
VN-14-...-T4-PQ3-VQ3-R02-A	18	QS-8	QS-8	50	7.5	166	98	63	8.7	-
VN-14-...-T4-PI5-VI5-R02-A		G1/4	G1/4	62						17
VN-05-...-T3-PQ2-VQ2-R01-M/B	14	QS-6	QS-6	48	7.6	132	71	55	10.7	-
VN-07-...-T3-PQ2-VQ2-R01-M/B						141				
VN-10-...-T3-PQ2-VQ2-R01-M/B										
VN-14-...-T4-PQ3-VQ3-R02-M/B	18	QS-8	QS-8	50	7.5	192	106	63	16.4	-

Note: This product conforms to ISO 1179-1 and to ISO 228-1

Dimensions – T-type/Standard, VN-20/30

Download CAD data → www.festo.com

VN-...-T6-PQ4-VQ5-R02-M

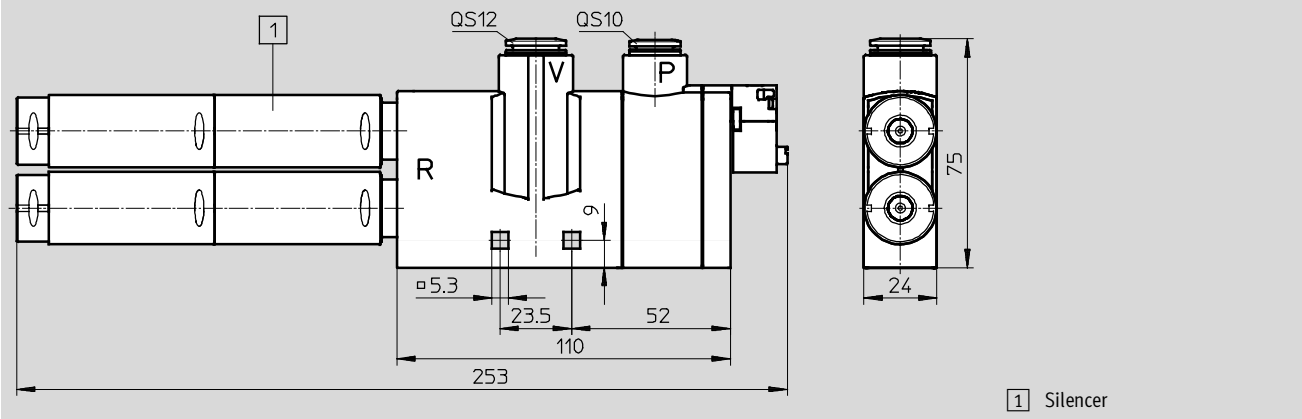

Dimensions – Straight type/Inline, VN-05/07

Download CAD data → www.festo.com

VN-05/07-...-I3-PQ2-VQ2-A

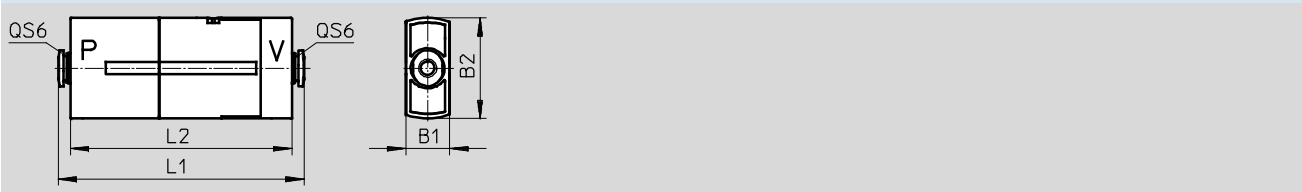

Type	B1	Connections		B2	L1	L2
		P	V			
VN-05-...-I3-PQ2-VQ2-A	14.5	QS-6	QS-6	33.1	81	73
VN-07-...-I3-PQ2-VQ2-A					97	89

Vacuum generators VN-A/M/B, with additional functions

FESTO

Technical data

Ordering data and weights – Standard						
T-type						
Nominal size of laval nozzle [mm]	Weight [g]	High vacuum H		Weight [g]	High suction rate L	
		Part No.	Type		Part No.	Type
With pneumatic ejector pulse, push-in fitting and silencer						
0.45	49	532620	VN-05-H-T3-PQ2-VQ2-R01-A	49	532621	VN-05-L-T3-PQ2-VQ2-R01-A
0.7	50	532628	VN-07-H-T3-PQ2-VQ2-R01-A	50	532629	VN-07-L-T3-PQ2-VQ2-R01-A
0.95	50	532638	VN-10-H-T3-PQ2-VQ2-R01-A	50	532639	VN-10-L-T3-PQ2-VQ2-R01-A
1.4	85	532646	VN-14-H-T4-PQ3-VQ3-R02-A	85	532647	VN-14-L-T4-PQ3-VQ3-R02-A
With pneumatic ejector pulse, female thread and silencer						
0.45	49	537225	VN-05-H-T3-PI4-VI4-R01-A	49	537226	VN-05-L-T3-PI4-VI4-R01-A
0.7	50	532632	VN-07-H-T3-PI4-VI4-R01-A	50	532633	VN-07-L-T3-PI4-VI4-R01-A
0.95	50	532642	VN-10-H-T3-PI4-VI4-R01-A	50	532643	VN-10-L-T3-PI4-VI4-R01-A
1.4	94	532719	VN-14-H-T4-PI5-VI5-R02-A	94	532720	VN-14-L-T4-PI5-VI5-R02-A
With electrical on-off valve, push-in fitting and silencer						
0.45	60	532618	VN-05-H-T3-PQ2-VQ2-R01-M	60	532619	VN-05-L-T3-PQ2-VQ2-R01-M
0.7	61	532626	VN-07-H-T3-PQ2-VQ2-R01-M	61	532627	VN-07-L-T3-PQ2-VQ2-R01-M
0.95	61	532636	VN-10-H-T3-PQ2-VQ2-R01-M	61	532637	VN-10-L-T3-PQ2-VQ2-R01-M
1.4	98	532644	VN-14-H-T4-PQ3-VQ3-R02-M	98	532645	VN-14-L-T4-PQ3-VQ3-R02-M
2.0	215	532656	VN-20-H-T6-PQ4-VQ5-R02-M	–	–	–
3.0	215	532662	VN-30-H-T6-PQ4-VQ5-R02-M	–	–	–
With electrical on-off valve, pneumatic ejector pulse, push-in fitting and silencer						
0.45	62	532622	VN-05-H-T3-PQ2-VQ2-R01-B	62	532623	VN-05-L-T3-PQ2-VQ2-R01-B
0.7	63	532630	VN-07-H-T3-PQ2-VQ2-R01-B	63	532631	VN-07-L-T3-PQ2-VQ2-R01-B
0.95	63	532640	VN-10-H-T3-PQ2-VQ2-R01-B	63	532641	VN-10-L-T3-PQ2-VQ2-R01-B
1.4	100	532648	VN-14-H-T4-PQ3-VQ3-R02-B	100	532649	VN-14-L-T4-PQ3-VQ3-R02-B



Ordering data and weights – Inline						
Inline						
Nominal size of laval nozzle [mm]	Weight [g]	High vacuum M		Weight [g]	High suction rate N	
		Part No.	Type		Part No.	Type
With pneumatic ejector pulse and push-in fitting						
0.45	38	532624	VN-05-M-I3-PQ2-VQ2-A	38	532625	VN-05-N-I3-PQ2-VQ2-A
0.7	41	532634	VN-07-M-I3-PQ2-VQ2-A	41	532635	VN-07-N-I3-PQ2-VQ2-A

Vacuum generator cartridges VN

Technical data

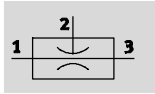
Function



-  - Temperature range
0 ... +60 °C
-  - Operating pressure
1 ... 8 bar



General technical data						
Type		VN-05	VN-07	VN-10	VN-14	VN-20
Nominal size of laval nozzle	[mm]	0.45	0.7	0.95	1.4	2.0
Ejector characteristic		High vacuum, T-type/Standard H				
		High suction rate, T-type/Standard L				
Mounting position		Any				

Operating and environmental conditions		
Operating pressure	[bar]	1 ... 8
Nominal operating pressure	[bar]	6
Operating medium		Compressed air in accordance with ISO 8573-1:2010 [7:4:4]
Note on operating/pilot medium		Operation with lubricated medium not possible
Ambient temperature	[°C]	0 ... +60
Temperature of medium	[°C]	0 ... +60
Corrosion resistance class CRC ¹⁾		2

1) Corrosion resistance class 2 to Festo standard 940 070
Components subject to moderate corrosion stress. Externally visible parts with primarily decorative surface requirements which are in direct contact with a normal industrial environment or media such as coolants or lubricating agents.

Performance data – High vacuum						
Ejector characteristic		Standard H				
Nominal size of laval nozzle	[mm]	0.45	0.7	0.95	1.4	2.0
Max. vacuum	[%]	92	92	93	92	92
Operating pressure for max. vacuum	[bar]	4.9	4.4	3.5	3.5	3.5
Max. suction rate with respect to atmosphere	[l/min]	7.2	16.2	21.8	48.8	98
Operating pressure for max. suction rate	[bar]	3	3	3	2	2
Air supply time at nominal operating pressure 6 bar (for 1 l volume)	[s]	4.43	1.67	1.02	0.48	0.23

Vacuum generator cartridges VN

Technical data

Performance data – High suction rate						
Ejector characteristic	Standard L					
Nominal size of laval nozzle [mm]	0.45	0.7	0.95	1.4	2.0	
Max. suction rate with respect to atmosphere [l/min]	13.6	30.9	41.5	92.6	184.4	
Operating pressure for max. suction rate [bar]	5	4	5	5	5	
Air supply time at nominal operating pressure 6 bar (for 1 l volume) [s]	2.04	0.82	0.66	0.31	0.17	

-  - Note

Twice the suction rate can be generated through parallel connection of two vacuum generator cartridges. The respective suction rate then

corresponds to the next highest performance level. Example: 2x20-H corresponds to 1x30-H

Materials

Sectional view

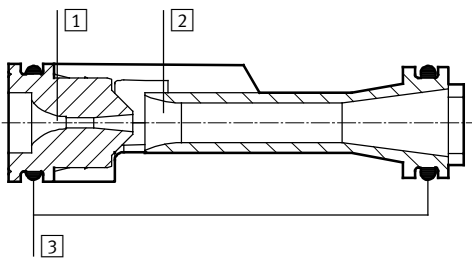

Vacuum generator cartridge VN-05/07/10/14/20		
1	Jet nozzle	Wrought aluminium alloy
2	Receiver nozzle	POM
3	Seals	NBR

-  - Note

The graphs plotting the technical data for the vacuum generator cartridge are the same as those for the vacuum generator VN-A/B/M. → From page 37.

Vacuum generator cartridges VN

Technical data

FESTO

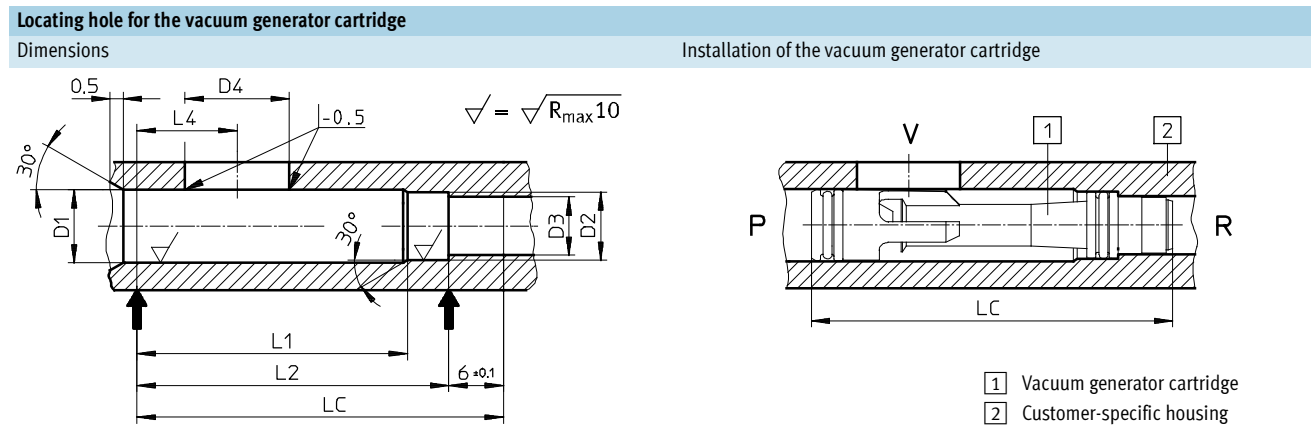
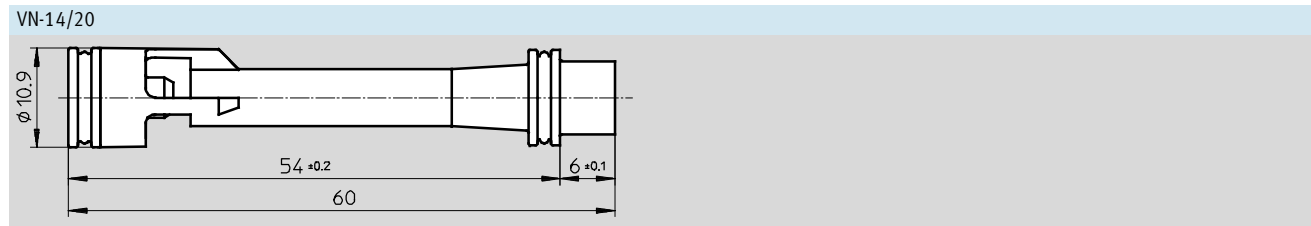
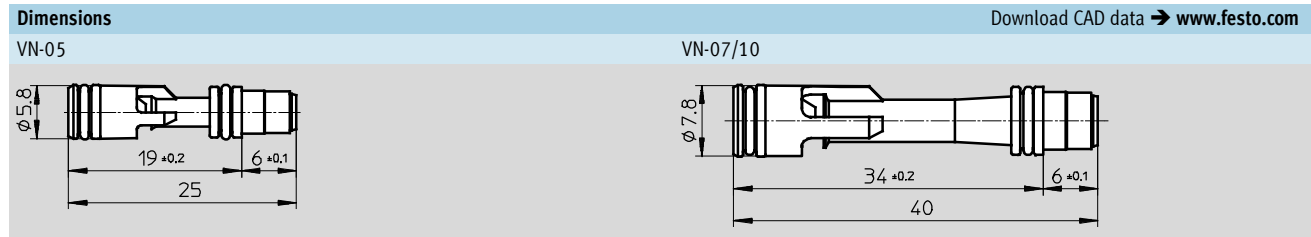

Type	Dimensions of the locating hole						Vacuum port		
	D1 ¹⁾ +0.05	D2	D3	L1	L2 ±0.2	LC ²⁾	L4 ±0.2	D4 min. Ø ³⁾ max. Ø	
VN-05	6	5.7 +0.05	4.9 +0.1	14	19	25	9.5	3.0	3.5
VN-07	8	7.5 +0.05	6.5 +0.1	29	34	40	11	6.0	7.5
VN-10									
VN-14	11.1	10.7 -0.05	9.4 ±0.1	49	54	60	13	12.8	15.6
VN-20									

- 1) For D1 with Ø 11.1: Select a core diameter of 11.8 +0.1 for a G3/4 threaded connection
- 2) Length of the vacuum generator cartridge
- 3) Minimum cross section, Festo recommends the largest possible cross section

Ordering data and weights

Nominal size of laval nozzle [mm]	Weight [g]	High vacuum H		Weight [g]	High suction rate L	
		Part No.	Type		Part No.	Type
0.45	0.65	547693	VN-05-H	0.65	547694	VN-05-L
0.7	1.65	547695	VN-07-H	1.65	547696	VN-07-L
0.95	1.65	547697	VN-10-H	1.65	547698	VN-10-L
1.4	3.75	547699	VN-14-H	3.75	547700	VN-14-L
2.0	3.75	547701	VN-20-H	3.75	547702	VN-20-L