

Service units MSB-FRC, MS series



Service units MSB-FRC, MS series

Product range overview – MS series service units

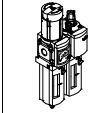
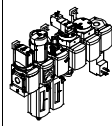
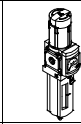
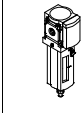
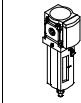
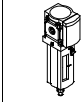
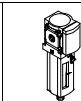

Type	Size	Pneumatic connection in housing	Connecting plate	Pressure regulation range [bar]						Grade of filtration [µm]			
				0.05 ...	0.05 ...	0.1 ...	0.3 ...	0.1 ...	0.5 ...	0.01	1	5	40
Code			AG...	D2	D4	D5	D6	D7	D8	A	B	C	E
Service units													
MSB-FRC 	4	G1/8, G1/4	G1/8, G1/4, G3/8	-	-	-	■	■	-	-	-	■	■
	6	G1/4, G3/8, G1/2	G1/4, G3/8, G1/2, G3/4	-	-	-	■	■	-	-	-	■	■
	9	-											
	12	-											
Service unit combinations (further variants can be ordered using the configurator → Internet: msb4, msb6 or msb9)													
MSB 	4	G1/4	G1/8, G1/4, G3/8	-	-	-	■	■	-	-	-	■	■
	6	G1/2	G1/4, G3/8, G1/2, G3/4	-	-	-	■	■	-	-	-	■	■
	9	-											
	12	-											
Individual devices													
Filter regulators MS-LFR 	4	G1/8, G1/4	G1/8, G1/4, G3/8	-	-	■	■	■	-	-	-	■	■
	6	G1/4, G3/8, G1/2	G1/4, G3/8, G1/2, G3/4	-	-	■	■	■	■	-	-	■	■
	9	G3/4, G1	G1/2, G3/4, G1, G1 1/4, G1 1/2	-	-	■	■	■	■	-	-	■	■
	12	-	G1, G1 1/4, G1 1/2, G2	-	-	-	■	■	■	-	-	■	■
Filters MS-LF 	4	G1/8, G1/4	G1/8, G1/4, G3/8	-	-	-	-	-	-	-	-	■	■
	6	G1/4, G3/8, G1/2	G1/4, G3/8, G1/2, G3/4	-	-	-	-	-	-	-	-	■	■
	9	G3/4, G1	G1/2, G3/4, G1, G1 1/4, G1 1/2	-	-	-	-	-	-	-	-	■	■
	12	-	G1, G1 1/4, G1 1/2, G2	-	-	-	-	-	-	-	-	■	■
Fine and micro filters MS-LFM 	4	G1/8, G1/4	G1/8, G1/4, G3/8	-	-	-	-	-	■	■	-	-	
	6	G1/4, G3/8, G1/2	G1/4, G3/8, G1/2, G3/4	-	-	-	-	-	■	■	-	-	
	9	G3/4, G1	G1/2, G3/4, G1, G1 1/4, G1 1/2	-	-	-	-	-	■	■	-	-	
	12	-	G1, G1 1/4, G1 1/2, G2	-	-	-	-	-	■	■	-	-	
Activated carbon filters MS-LFX 	4	G1/8, G1/4	G1/8, G1/4, G3/8	-	-	-	-	-	-	-	-	-	
	6	G1/4, G3/8, G1/2	G1/4, G3/8, G1/2, G3/4	-	-	-	-	-	-	-	-	-	
	9	G3/4, G1	G1/2, G3/4, G1, G1 1/4, G1 1/2	-	-	-	-	-	-	-	-	-	
	12	-	G1, G1 1/4, G1 1/2, G2	-	-	-	-	-	-	-	-	-	
Water separators MS-LWS 	4	-											
	6	G1/4, G3/8, G1/2	G1/4, G3/8, G1/2, G3/4	-	-	-	-	-	-	-	-	-	-
	9	G3/4, G1	G1/2, G3/4, G1, G1 1/4, G1 1/2	-	-	-	-	-	-	-	-	-	-
	12	-	G1, G1 1/4, G1 1/2, G2	-	-	-	-	-	-	-	-	-	-

Service units MSB-FRC, MS series

Product range overview – MS series service units

Type	Size	Bowl guard		Condensate drains				Pressure indicator				Security		Options		→ Page/ Internet	
		Plastic bowl with plastic bowl guard	Metal bowl	Manual rotary	Semi-automatic	Fully automatic	External, fully automatic, electrical	Cover plate (without pressure gauge)	Integrated MS pressure gauge	Adapter plate for EN pressure gauge G1/8	Adapter plate for EN pressure gauge G1/4	Pressure sensor	Rotary knob with detent, lockable via accessories	Rotary knob with integrated lock	Silencer		Flow direction from right to left
Code		R	U	M	H	V	E...	VS	AG	A8	A4	AD...	AS	E11	S	Z	
Service units																	
MSB-FRC	4	■	-	■	-	■	-	-	■	-	-	-	■	-	-	■	8
	6	■	■	■	-	■	-	-	■	-	-	-	■	-	-	■	8
	9	-	-	-	-	-	-	-	-	-	-	-	-	-	-	-	-
	12	-	-	-	-	-	-	-	-	-	-	-	-	-	-	-	-
Service unit combinations																	
MSB	4	■	■	■	-	■	-	-	■	-	-	-	■	-	-	■	msb4
	6	■	■	■	-	■	-	-	■	-	-	-	■	-	-	■	msb6
	9	-	-	-	-	-	-	-	-	-	-	-	-	-	-	-	-
	12	-	-	-	-	-	-	-	-	-	-	-	-	-	-	-	-
Individual devices																	
Filter regulators MS-LFR	4	■	■	■	■	■	-	■	■	■	■	■	■	■	-	■	ms4-lfr
	6	■	■	■	■	■	■	■	■	■	■	■	■	■	-	■	ms6-lfr
	9	-	■	■	■	■	■	■	■	■	■	■	■	■	-	■	ms9-lfr
	12	-	■	■	-	■	■	■	■	■	■	■	■	■	-	■	ms12-lfr
Filters MS-LF	4	■	■	■	■	■	-	-	-	-	-	-	-	-	-	■	ms4-lf
	6	■	■	■	■	■	■	-	-	-	-	-	-	-	-	■	ms6-lf
	9	-	■	■	■	■	■	-	-	-	-	-	-	-	-	■	ms9-lf
	12	-	■	■	-	■	■	-	-	-	-	-	-	-	-	■	ms12-lf
Fine and micro filters MS-LFM	4	■	■	■	■	■	-	-	-	-	-	-	-	-	-	■	ms4-lfm
	6	■	■	■	■	■	■	-	-	-	-	-	-	-	-	■	ms6-lfm
	9	-	■	■	■	■	■	-	-	-	-	-	-	-	-	■	ms9-lfm
	12	-	■	■	-	■	■	-	-	-	-	-	-	-	-	■	ms12-lfm
Activated carbon filters MS-LFX	4	■	■	-	-	-	-	-	-	-	-	-	-	-	-	■	ms4-lfx
	6	■	■	-	-	-	-	-	-	-	-	-	-	-	-	■	ms6-lfx
	9	-	■	-	-	-	-	-	-	-	-	-	-	-	-	■	ms9-lfx
	12	-	■	-	-	-	-	-	-	-	-	-	-	-	-	■	ms12-lfx
Water separators MS-LWS	4	-	-	-	-	-	-	-	-	-	-	-	-	-	-	-	-
	6	-	■	-	-	■	■	-	-	-	-	-	-	-	-	■	ms6-lws
	9	-	■	-	-	■	■	-	-	-	-	-	-	-	-	■	ms9-lws
	12	-	■	-	-	■	■	-	-	-	-	-	-	-	-	■	ms12-lws

Service units MSB-FRC, MS series

Product range overview – MS series service units



Type	Size	Pneumatic connection in housing	Connecting plate	Pressure regulation range [bar]						Supply voltage			
				0.05 ... 0.7	0.05 ... 2.5	0.1 ... 4	0.3 ... 7	0.1 ... 12	0.5 ... 16	24 V DC, connection pattern to EN 175301	24 V DC, connection M12 to IEC 61076-2-101	110 V AC, connection pattern to EN 175301	230 V AC, connection pattern to EN 175301
Code			AG...	D2	D4	D5	D6	D7	D8	V24	V24P	V110	V230
Individual devices													
Pressure regulators MS-LR		4	G1/8, G1/4	G1/8, G1/4, G3/8	-	-	■	■	■	-	-	-	-
		6	G1/4, G3/8, G1/2	G1/4, G3/8, G1/2, G3/4	-	-	■	■	■	■	-	-	-
		9	G3/4, G1	G1/2, G3/4, G1, G1 1/4, G1 1/2	-	-	■	■	■	■	-	-	-
		12	-	G1, G1 1/4, G1 1/2, G2	-	-	-	■	■	■	-	-	-
Pressure regulators MS-LRB		4	G1/4	G1/8, G1/4, G3/8	-	-	■	■	■	-	-	-	-
		6	G1/2	G1/4, G3/8, G1/2, G3/4	-	-	■	■	■	■	-	-	-
		9	-	-	-	-	-	-	-	-	-	-	-
		12	-	-	-	-	-	-	-	-	-	-	-
Precision pressure regulators MS-LRP		4	-	-	-	-	-	-	-	-	-	-	-
		6	G1/4, G3/8, G1/2	G1/4, G3/8, G1/2, G3/4	■	■	■	-	■	-	-	-	-
		9	-	-	-	-	-	-	-	-	-	-	-
		12	-	-	-	-	-	-	-	-	-	-	-
Precision pressure regulators MS-LRPB		4	-	-	-	-	-	-	-	-	-	-	-
		6	G1/2	G1/4, G3/8, G1/2, G3/4	■	■	■	-	■	-	-	-	-
		9	-	-	-	-	-	-	-	-	-	-	-
		12	-	-	-	-	-	-	-	-	-	-	-
Electrical pressure regulators MS-LRE		4	-	-	-	-	-	-	-	-	-	-	-
		6	G1/4, G3/8, G1/2	G1/4, G3/8, G1/2, G3/4	-	-	■	■	■	■	-	-	-
		9	-	-	-	-	-	-	-	-	-	-	-
		12	-	-	-	-	-	-	-	-	-	-	-
Lubricators MS-LOE		4	G1/8, G1/4	G1/8, G1/4, G3/8	-	-	-	-	-	-	-	-	-
		6	G1/4, G3/8, G1/2	G1/4, G3/8, G1/2, G3/4	-	-	-	-	-	-	-	-	-
		9	G3/4, G1	G1/2, G3/4, G1, G1 1/4, G1 1/2	-	-	-	-	-	-	-	-	-
		12	-	G1, G1 1/4, G1 1/2, G2	-	-	-	-	-	-	-	-	-
On-off valves, manually actuated MS-EM(1)		4	G1/8, G1/4	G1/8, G1/4, G3/8	-	-	-	-	-	-	-	-	-
		6	G1/4, G3/8, G1/2	G1/4, G3/8, G1/2, G3/4	-	-	-	-	-	-	-	-	-
		9	G3/4, G1	G1/2, G3/4, G1, G1 1/4, G1 1/2	-	-	-	-	-	-	-	-	-
		12	-	G1, G1 1/4, G1 1/2, G2	-	-	-	-	-	-	-	-	-
On-off valves, electrically actuated MS-EE		4	G1/8, G1/4	G1/8, G1/4, G3/8	-	-	-	-	-	-	■	-	■
		6	G1/4, G3/8, G1/2	G1/4, G3/8, G1/2, G3/4	-	-	-	-	-	-	■	-	■
		9	G3/4, G1	G1/2, G3/4, G1, G1 1/4, G1 1/2	-	-	-	-	-	-	■	■	■
		12	-	G1, G1 1/4, G1 1/2, G2	-	-	-	-	-	-	■	■	■
Soft-start valves, pneumatically actuated MS-DL		4	G1/8, G1/4	G1/8, G1/4, G3/8	-	-	-	-	-	-	-	-	-
		6	G1/4, G3/8, G1/2	G1/4, G3/8, G1/2, G3/4	-	-	-	-	-	-	-	-	-
		9	-	-	-	-	-	-	-	-	-	-	-
		12	-	G1, G1 1/4, G1 1/2, G2	-	-	-	-	-	-	-	-	-
Soft-start valves, electrically actuated MS-DE		4	G1/8, G1/4	G1/8, G1/4, G3/8	-	-	-	-	-	-	■	-	■
		6	G1/4, G3/8, G1/2	G1/4, G3/8, G1/2, G3/4	-	-	-	-	-	-	■	-	■
		9	-	-	-	-	-	-	-	-	-	-	-
		12	-	G1, G1 1/4, G1 1/2, G2	-	-	-	-	-	-	■	■	■

Service units MSB-FRC, MS series

Product range overview – MS series service units



Type	Size	Bowl guard		Pressure indicator				Security			Options		→ Page/ Internet
		Plastic bowl with plastic bowl guard	Metal bowl	Cover plate (without pressure gauge)	Integrated MS pressure gauge	Adapter plate for EN pressure gauge G1/8	Adapter plate for EN pressure gauge G1/4	Pressure sensor	Rotary knob with detent, lockable via accessories	Rotary knob with integrated lock	Silencer	Flow direction from right to left	
Code		R	U	VS	AG	A8	A4	AD...	AS	E11	S	Z	
Individual devices													
Pressure regulators MS-LR	4	-	-	■	■	■	■	■	■	■	-	■	ms4-lr
	6	-	-	■	■	-	■	■	■	■	-	■	ms6-lr
	9	-	-	■	■	-	■	■	■	■	-	■	ms9-lr
	12	-	-	■	■	-	■	-	■	■	-	■	ms12-lr
Pressure regulators MS-LRB	4	-	-	■	■	■	■	■	■	■	-	■	ms4-lrb
	6	-	-	■	■	-	■	■	■	■	-	■	ms6-lrb
	9	-	-	-	-	-	-	-	-	-	-	-	-
	12	-	-	-	-	-	-	-	-	-	-	-	-
Precision pressure regulators MS-LRP	4	-	-	-	-	-	-	-	-	-	-	-	-
	6	-	-	■	-	■	■	■	■	■	-	■	ms6-lrp
	9	-	-	-	-	-	-	-	-	-	-	-	-
	12	-	-	-	-	-	-	-	-	-	-	-	-
Precision pressure regulators MS-LRPB	4	-	-	-	-	-	-	-	-	-	-	-	-
	6	-	-	■	-	■	■	■	■	■	-	■	ms6-lrpb
	9	-	-	-	-	-	-	-	-	-	-	-	-
	12	-	-	-	-	-	-	-	-	-	-	-	-
Electrical pressure regulators MS-LRE	4	-	-	-	-	-	-	-	-	-	-	-	-
	6	-	-	■	■	-	■	-	-	-	-	■	ms6-lre
	9	-	-	-	-	-	-	-	-	-	-	-	-
	12	-	-	-	-	-	-	-	-	-	-	-	-
Lubricators MS-LOE	4	■	■	-	-	-	-	-	-	-	-	■	ms4-loe
	6	■	■	-	-	-	-	-	-	-	-	■	ms6-loe
	9	-	■	-	-	-	-	-	-	-	-	■	ms9-loe
	12	-	■	-	-	-	-	-	-	-	-	■	ms12-loe
On-off valves, manually actuated MS-EM(1)	4	-	-	■	■	■	■	■	-	-	■	■	ms4-em1
	6	-	-	■	■	-	■	■	-	-	■	■	ms6-em1
	9	-	-	■	■	-	■	-	-	-	■	■	ms9-em
	12	-	-	■	■	-	■	-	-	-	■	■	ms12-em
On-off valves, electrically actuated MS-EE	4	-	-	■	■	■	■	■	-	-	■	■	ms4-ee
	6	-	-	■	■	-	■	■	-	-	■	■	ms6-ee
	9	-	-	■	■	-	■	-	-	-	■	■	ms9-ee
	12	-	-	■	■	-	■	-	-	-	■	■	ms12-ee
Soft-start valves, pneumatically actuated MS-DL	4	-	-	■	■	■	■	■	-	-	-	■	ms4-dl
	6	-	-	■	■	-	■	■	-	-	-	■	ms6-dl
	9	-	-	-	-	-	-	-	-	-	-	-	-
	12	-	-	■	■	-	■	-	-	-	-	■	ms12-dl
Soft-start valves, electrically actuated MS-DE	4	-	-	■	■	■	■	■	-	-	-	■	ms4-de
	6	-	-	■	■	-	■	■	-	-	-	■	ms6-de
	9	-	-	-	-	-	-	-	-	-	-	-	-
	12	-	-	■	■	-	■	-	-	-	-	■	ms12-de

Service units MSB-FRC, MS series

Product range overview – MS series service units



Type	Size	Pneumatic connection in housing	Connecting plate	Performance Level		Supply voltage				
				Category 1, 1-channel	Category 4, 2-channel with self-monitoring	24 V DC, connection pattern to EN 175301	24 V DC, connection M12 to IEC 61076-2-101 / to EN 60947-5-2	110 V AC, connection pattern to EN 175301	230 V AC, connection pattern to EN 175301	
Code			AG...	C	E	V24	V24P	V110	V230	
Individual devices										
Soft start and exhaust valves MS-SV-C		4	–							
		6	G $\frac{1}{2}$	G $\frac{1}{4}$, G $\frac{3}{8}$, G $\frac{1}{2}$, G $\frac{3}{4}$	■	–	■	■	■	■
		9	G $\frac{3}{4}$, G1	G $\frac{1}{2}$, G $\frac{3}{4}$, G1, G1 $\frac{1}{4}$, G1 $\frac{1}{2}$	■	–	■	■	■	■
		12	–							
Soft start and exhaust valves MS-SV-E		4	–							
		6	G $\frac{1}{2}$	G $\frac{1}{4}$, G $\frac{3}{8}$, G $\frac{1}{2}$, G $\frac{3}{4}$	–	■	■	–	–	–
		9	–							
		12	–							
Membrane air dryers MS-LDM1		4	G $\frac{1}{8}$, G $\frac{1}{4}$	G $\frac{1}{8}$, G $\frac{1}{4}$, G $\frac{3}{8}$	–	–	–	–	–	–
		6	G $\frac{1}{4}$, G $\frac{3}{8}$, G $\frac{1}{2}$	G $\frac{1}{4}$, G $\frac{3}{8}$, G $\frac{1}{2}$, G $\frac{3}{4}$	–	–	–	–	–	–
		9	–							
		12	–							
Branching modules MS-FRM		4	G $\frac{1}{8}$, G $\frac{1}{4}$	G $\frac{1}{8}$, G $\frac{1}{4}$, G $\frac{3}{8}$	–	–	–	–	–	–
		6	G $\frac{1}{4}$, G $\frac{3}{8}$, G $\frac{1}{2}$	G $\frac{1}{4}$, G $\frac{3}{8}$, G $\frac{1}{2}$, G $\frac{3}{4}$	–	–	–	–	–	–
		9	G $\frac{3}{4}$, G1	G $\frac{1}{2}$, G $\frac{3}{4}$, G1, G1 $\frac{1}{4}$, G1 $\frac{1}{2}$	–	–	–	–	–	–
		12	–	G1, G1 $\frac{1}{4}$, G1 $\frac{1}{2}$, G2	–	–	–	–	–	–
Distributor blocks MS-FRM-FRZ		4	G $\frac{1}{4}$	–	–	–	–	–	–	
		6	G $\frac{1}{2}$	–	–	–	–	–	–	
		9	–							
		12	–							
Flow sensors SFAM		4	–							
		6	G $\frac{1}{2}$	G $\frac{1}{2}$	–	–	–	–	–	–
		9	–	G1, G1 $\frac{1}{2}$	–	–	–	–	–	–
		12	–							

Service units MSB-FRC, MS series

Product range overview – MS series service units

Type	Size	Bowl guard		Pressure indicator					Switch output			Options		→ Page/ Internet
		Plastic bowl with plastic bowl guard	Metal bowl	Cover plate (without pressure gauge)	Integrated MS pressure gauge	Adapter plate for EN pressure gauge G1/8	Adapter plate for EN pressure gauge G1/4	Pressure sensor	2x PNP or NPN, 1 analogue output 4 ... 20 mA	2x PNP or NPN, 1 analogue output 0 ... 10 V	Silencer	Flow direction from right to left		
Code		R	U	VS	AG	A8	A4	AD...	2SA	2SV	S	Z/R		
Individual devices														
Soft start and exhaust valves MS-SV-C	4	-												
	6	-	-	■	■	-	■	■	-	-	■	■	ms6-sv	
	9	-	-	■	■	-	■	■	-	-	■	■	ms9-sv	
	12	-											-	
Soft start and exhaust valves MS-SV-E	4	-											-	
	6	-	-	■	■	-	■	■	-	-	■	■	ms6-sv	
	9	-											-	
	12	-											-	
Membrane air dryers MS-LDM1	4	-	■	-	-	-	-	-	-	-	-	■	ms4-ldm1	
	6	-	■	-	-	-	-	-	-	-	-	■	ms6-ldm1	
	9	-											-	
	12	-											-	
Branching modules MS-FRM	4	-	-	■	■	■	■	■	-	-	-	■	ms4-frm	
	6	-	-	■	■	-	■	■	-	-	-	■	ms6-frm	
	9	-	-	■	■	-	■	■	-	-	-	■	ms9-frm	
	12	-	-	■	-	-	-	-	-	-	-	-	ms12-frm	
Distributor blocks MS-FRM-FRZ	4	-	-	-	-	-	-	-	-	-	-	■	ms4-frm	
	6	-	-	-	-	-	-	-	-	-	-	■	ms6-frm	
	9	-											-	
	12	-											-	
Flow sensors SFAM	4	-											-	
	6	-	-	-	-	-	-	-	■	■	-	■	sfam-62	
	9	-	-	-	-	-	-	-	■	■	-	■	sfam-90	
	12	-											-	

Service units MSB4/MSB6-FRC, MS series

Peripherals overview

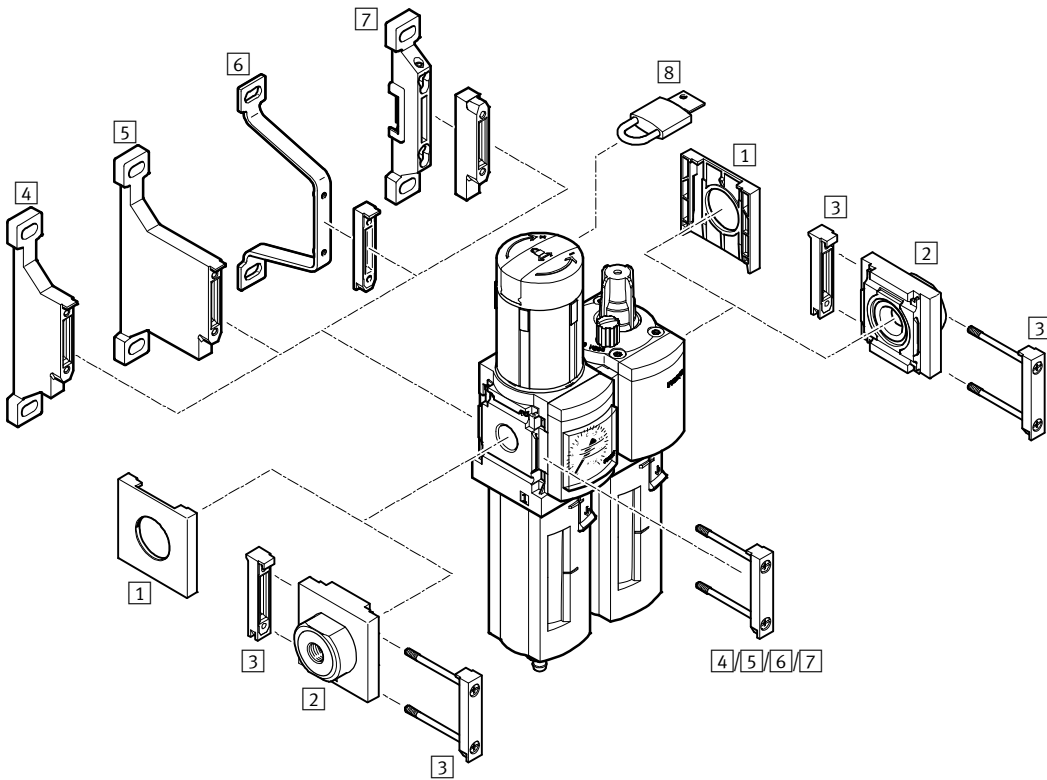

Mounting attachments and accessories		→ Page/Internet
1	Cover cap MS4/6-END	ms4-end, ms6-end
2	Connecting plate-SET MS4/6-AG...	ms4-ag, ms6-ag
3	Module connector MS4/6-MV	ms4-mv, ms6-mv
4	Mounting bracket MS4/6-WP	ms4-wp, ms6-wp
5	Mounting bracket MS4/6-WPB	ms4-wp, ms6-wp
6	Mounting bracket MS4/6-WPE	ms4-wp, ms6-wp
7	Mounting bracket MS4/6-WPM	ms4-wp, ms6-wp
8	Padlock LRVS-D	16

Service units MSB4/MSB6-FRC, MS series

Type codes

MSB 6 - 3/8 - FRC5:J1 M1

Series

MSB	Service unit
-----	--------------

Size

4	Grid dimension 40 mm
6	Grid dimension 62 mm

Pneumatic connection

MSB4	
1/8	Thread G1/8
1/4	Thread G1/4
MSB6	
1/4	Thread G1/4
3/8	Thread G3/8
1/2	Thread G1/2

Service unit consisting of:

- Filter regulator with pressure gauge, rotary knob with detent, lockable via accessories
- Lubricator

Pressure regulation range 0.3 ... 7 bar

Plastic bowl guard	
FRC1:J5	Grade of filtration 40 µm, manual rotary condensate drain

Pressure regulation range 0.5 ... 12 bar

Plastic bowl guard	
FRC7:J3	Grade of filtration 5 µm, manual rotary condensate drain
FRC5:J1	Grade of filtration 40 µm, manual rotary condensate drain
FRC6:J2	Grade of filtration 40 µm, fully automatic condensate drain
Metal bowl	
FRC11:J9	Grade of filtration 5 µm, manual rotary condensate drain
FRC12:J10	Grade of filtration 5 µm, fully automatic condensate drain
FRC9:J11	Grade of filtration 40 µm, manual rotary condensate drain
FRC10:J12	Grade of filtration 40 µm, fully automatic condensate drain

Lubricators

M1	Plastic bowl guard
M2	Metal bowl

Service units MSB4/MSB6-FRC, MS series

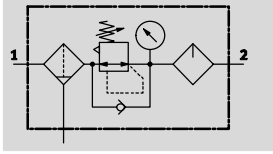

Technical data

Function
With condensate drain
manual rotary

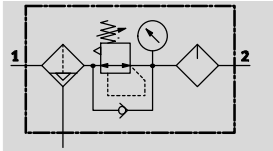

With condensate drain
fully automatic



-  - Flow rate
850 ... 4,800 l/min
-  - Temperature range
-10 ... +60 °C
-  - Operating pressure
1.5 ... 20 bar



- Filter, regulator and lubricator function in a single unit
- High flow rate and highly efficient removal of contaminants
- Good regulating characteristics with minimal pressure hysteresis
- Setting values are secured by locking the rotary knob
- Lockable rotary knob
- Two pressure regulation ranges: 0.3 ... 7 bar and 0.5 ... 12 bar
- With manual or integrated, fully automatic condensate drain
- Choice of filter cartridges: 5 µm or 40 µm
- New filter cartridges → 16, Festo special oil → 16

General technical data		
Size	MSB4	MSB6
Pneumatic connection 1, 2	G ¹ / ₈	-
	G ¹ / ₄	G ¹ / ₄
	-	G ³ / ₈
	-	G ¹ / ₂
Design	Filter regulator with pressure gauge	
	Proportional standard mist lubricator	
Regulating function	Output pressure constant, with primary pressure compensation, with return flow function, with secondary venting	
Type of mounting	Via accessories	
Assembly position	Vertical ±5°	
Grade of filtration [µm]	5	
	40	
Air purity class at the output	Compressed air in accordance with ISO 8573-1:2010 [6:4:-] (grade of filtration 5 µm)	
	Compressed air in accordance with ISO 8573-1:2010 [7:4:-] (grade of filtration 40 µm)	
Bowl guard	Plastic bowl guard	Plastic bowl guard
	-	Integrated as metal bowl
Condensate drains	Manual rotary	
	Fully automatic	
Actuator lock	Rotary knob with detent, lockable via accessories	
Pressure regulation range [bar]	0.3 ... 7	
	0.5 ... 12	
Pressure indicator	With pressure gauge	

-||- Note: This product conforms to ISO 1179-1 and to ISO 228-1

Service units MSB4/MSB6-FRC, MS series

Technical data

Standard nominal flow rate $q_{nN}^{1)}$ [l/min]						
Size	MSB4			MSB6		
Pneumatic connection	G $\frac{1}{8}$	G $\frac{1}{4}$	G $\frac{1}{4}$	G $\frac{3}{8}$	G $\frac{1}{2}$	
Pressure regulation range 0.3... 7 bar						
Grade of filtration	40 μ m	–	1,400	–	–	4,800
Pressure regulation range 0.5... 12 bar						
Grade of filtration	5 μ m	–	850	–	–	3,600
	40 μ m	850	900	1,900	3,500	3,700

1) Measured at $p_1 = 10$ bar and $p_2 = 6$ bar, $\Delta p = 1$ bar.

Operating and environmental conditions				
Condensate drains	Manual rotary		Fully automatic	
Size	MSB4	MSB6	MSB4	MSB6
Operating pressure [bar]	1.5 ... 14		2 ... 12	
Operating medium	Compressed air in accordance with ISO 8573-1:2010 [-:4:-]		Compressed air in accordance with ISO 8573-1:2010 [7:4:-]	
	Inert gases			
Note on operating/pilot medium	Operation with lubricated medium possible (in which case lubricated operation will always be required)			
Ambient temperature [°C]	-10 ... +60		+5 ... +60	
Temperature of medium [°C]	-10 ... +60		+5 ... +60	
Storage temperature [°C]	-10 ... +60		-10 ... +60	
Corrosion resistance	CRC ¹⁾	2		

1) Corrosion resistance class 2 according to Festo standard 940 070
Components requiring moderate corrosion resistance. Externally visible parts with primarily decorative surface requirements which are in direct contact with a normal industrial environment or media such as coolants or lubricating agents.

Weights [g]		
Size	MSB4	MSB6
With plastic bowl guard	500	1,495
With metal bowl	–	1,713

Materials

Sectional view

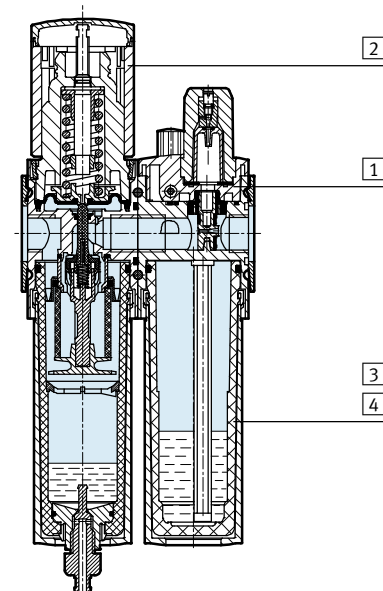

Service unit		
1	Body	Die-cast aluminium
2	Regulating knob	PA/POM
3	Plastic bowl guard	PC
4	Metal bowl	Wrought aluminium alloy
–	Seals	NBR

Service units MSB4/MSB6-FRC, MS series

Technical data



Standard flow rate q_n as a function of output pressure p_2

Pressure regulation range 0.3 ... 7 bar Grade of filtration 5 μm
MSB4-1/4

Grade of filtration 40 μm

Primary pressure $p_1 = 10$ bar

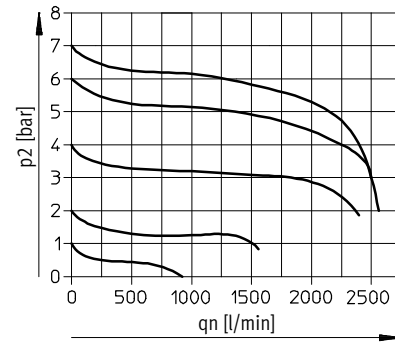

Pressure regulation range 0.5 ... 12 bar Grade of filtration 5 μm
MSB4-1/8

Grade of filtration 40 μm

Primary pressure $p_1 = 10$ bar

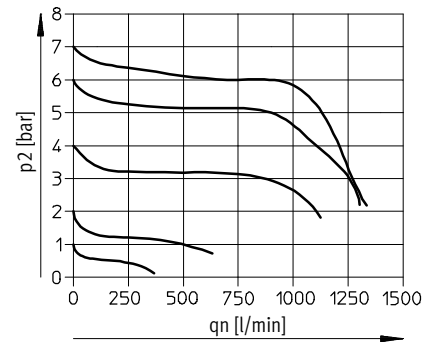

MSB4-1/4

Primary pressure $p_1 = 10$ bar

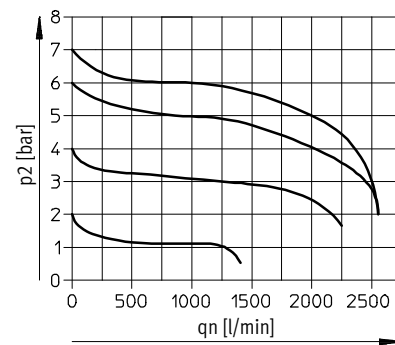
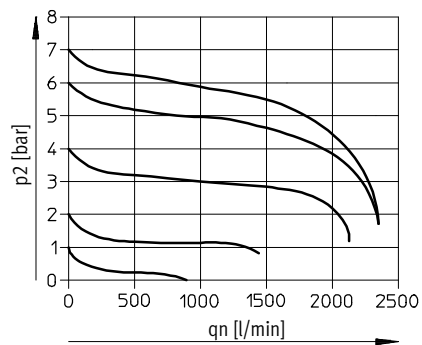

Service units MSB4/MSB6-FRC, MS series

Technical data

Standard flow rate q_n as a function of output pressure p_2

Pressure regulation range 0.3 ... 7 bar Grade of filtration 5 μm

MSB6-1/2

Primary pressure $p_1 = 10$ bar

Grade of filtration 40 μm

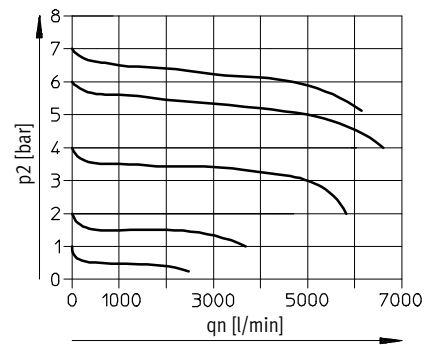

Pressure regulation range 0.5 ... 12 bar Grade of filtration 5 μm

MSB6-1/4

Primary pressure $p_1 = 10$ bar

Grade of filtration 40 μm

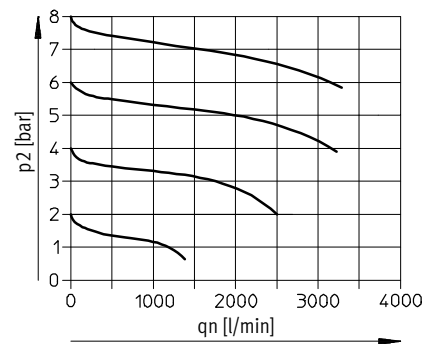

MSB6-3/8

Primary pressure $p_1 = 10$ bar

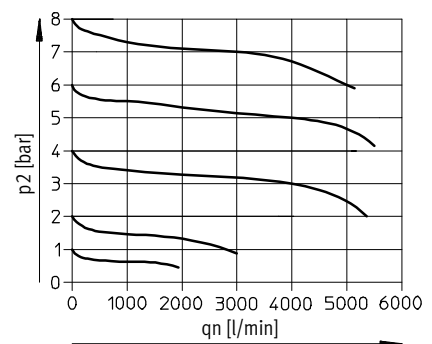

MSB6-1/2

Primary pressure $p_1 = 10$ bar

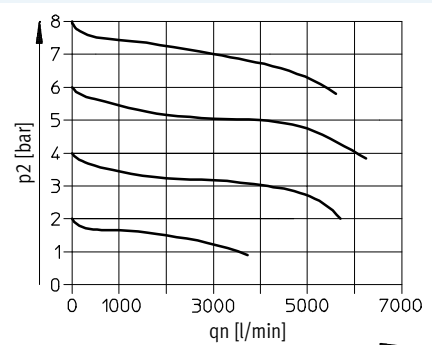
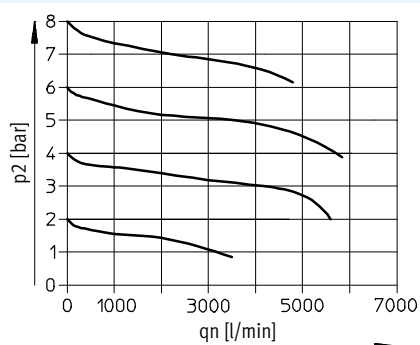

Service units MSB4/MSB6-FRC, MS series

Technical data

FESTO

Dimensions

Download CAD data → www.festo.com

With pressure gauge, display unit [bar]

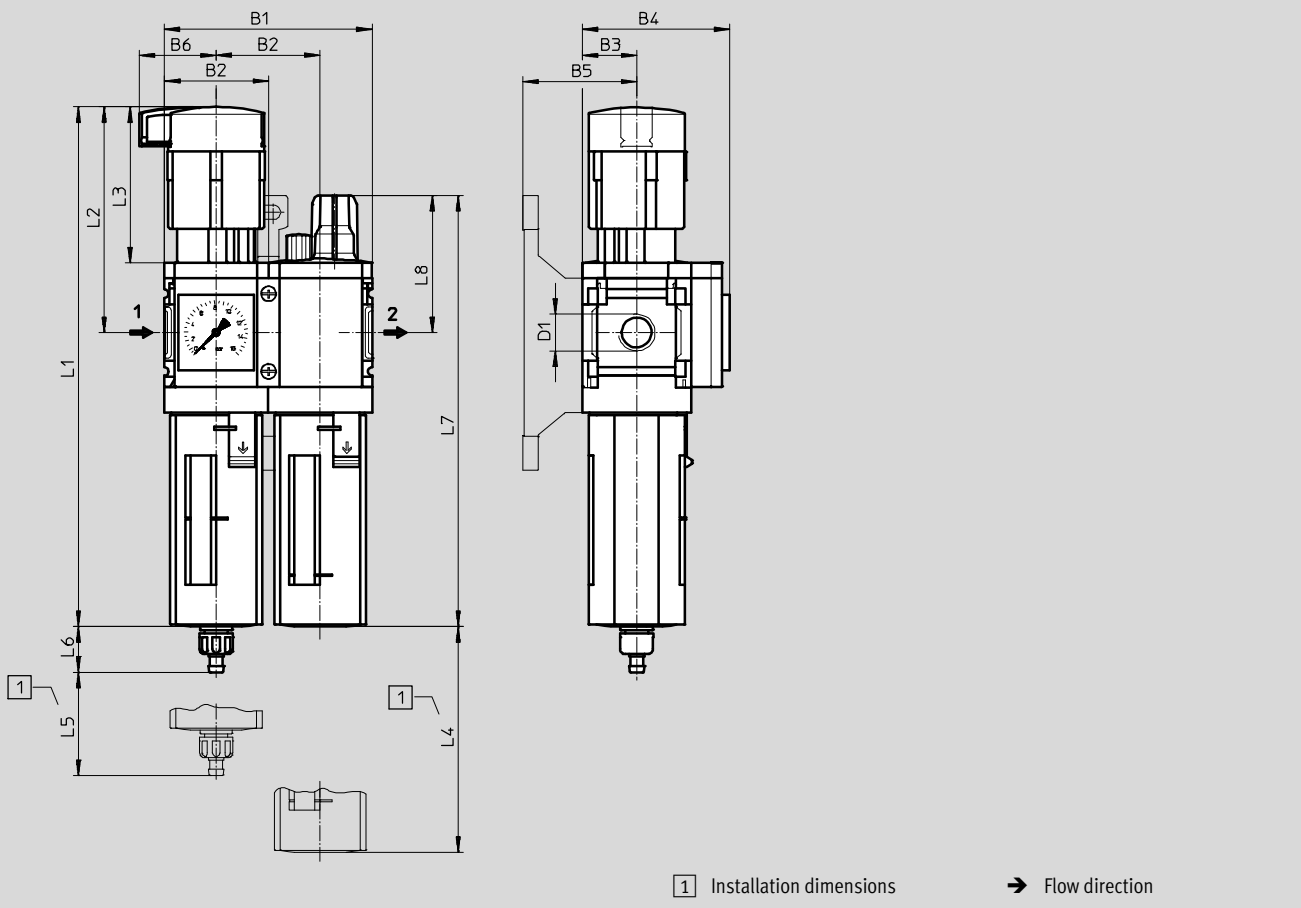

Type	B1	B2	B3	B4	B5	B6	D1	L1	L2	L3	L4	L5	L6		L7	L8
													Condensate drain manual rotary	Condensate drain fully auto- matic		
MSB4-1/8	80.4	40.2	21	57	44	29.7	G1/8	201	87	60	80	25	17.7	20.4	167	53
MSB4-1/4							G1/4									
MSB6-1/4	124	62	31	77	54	38.8	G1/4	284.8	134.5	95.5	130	68	15.8	18.5	215.3	65.6
MSB6-3/8							G3/8									
MSB6-1/2							G1/2									

• Note: This product conforms to ISO 1179-1 and to ISO 228-1

Service units MSB4/MSB6-FRC, MS series

FESTO

Technical data

Ordering data						
Pressure regulation range 0.3 ... 7 bar						
Size	Condensate drain	Connection	Grade of filtration 5 µm		Grade of filtration 40 µm	
			Part No.	Type	Part No.	Type
Plastic bowl guard						
MSB4	manual rotary	G $\frac{1}{4}$	–	–	531109	MSB4-$\frac{1}{4}$-FRC1:J5M1
MSB6	manual rotary	G $\frac{1}{2}$	–	–	530230	MSB6-$\frac{1}{2}$-FRC1:J5M1

Ordering data						
Pressure regulation range 0.5 ... 12 bar						
Size	Condensate drain	Connection	Grade of filtration 5 µm		Grade of filtration 40 µm	
			Part No.	Type	Part No.	Type
Plastic bowl guard						
MSB4	manual rotary	G $\frac{1}{8}$	–	–	531133	MSB4-$\frac{1}{8}$-FRC5:J1M1
		G $\frac{1}{4}$	531121	MSB4-$\frac{1}{4}$-FRC7:J3M1	531117	MSB4-$\frac{1}{4}$-FRC5:J1M1
	fully automatic	G $\frac{1}{4}$	–	–	531119	MSB4-$\frac{1}{4}$-FRC6:J2M1
MSB6	manual rotary	G $\frac{1}{4}$	–	–	530268	MSB6-$\frac{1}{4}$-FRC5:J1M1
		G $\frac{3}{8}$	–	–	530292	MSB6-$\frac{3}{8}$-FRC5:J1M1
		G $\frac{1}{2}$	530248	MSB6-$\frac{1}{2}$-FRC7:J3M1	530244	MSB6-$\frac{1}{2}$-FRC5:J1M1
	fully automatic	G $\frac{1}{2}$	–	–	530246	MSB6-$\frac{1}{2}$-FRC6:J2M1
Metal bowl						
MSB6	manual rotary	G $\frac{1}{2}$	530234	MSB6-$\frac{1}{2}$-FRC11:J9M2	530252	MSB6-$\frac{1}{2}$-FRC9:J11M2
		G $\frac{1}{2}$	530236	MSB6-$\frac{1}{2}$-FRC12:J10M2	530232	MSB6-$\frac{1}{2}$-FRC10:J12M2

Service units MSB-FRC, MS series

Accessories

FESTO

Filter cartridges



Ordering data			
Size	Grade of filtration [µm]	Part No.	Type
MS4	5 (colour: blue)	534501	MS4-LFP-C
	40 (colour: white)	534502	MS4-LFP-E
MS6	5 (colour: blue)	534499	MS6-LFP-C
	40 (colour: white)	534500	MS6-LFP-E

Special oil



Ordering data			
Scope of delivery		Part No.	Type
1 litre		152811	OFSW-32

Ordering data – Padlock LRV5-D			
	Weight [g]	Part No.	Type
	120	193786	LRV5-D