

Membrane air dryers MS-LDM1, MS series



Membrane air dryers MS-LDM1, MS series

FESTO

Product range overview – MS series service units

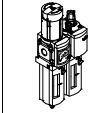
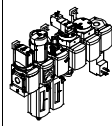
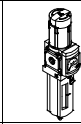
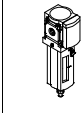
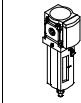
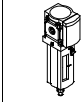
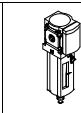
Type	Size	Pneumatic connection in housing	Connecting plate	Pressure regulation range [bar]						Grade of filtration [µm]			
				0.05 ... 0.7	0.05 ... 2.5	0.1 ... 4	0.3 ... 7	0.1 ... 12	0.5 ... 16	0.01	1	5	40
Code			AG...	D2	D4	D5	D6	D7	D8	A	B	C	E
Service units													
MSB-FRC 	4	G1/8, G1/4	G1/8, G1/4, G3/8	-	-	-	■	■	-	-	-	■	■
	6	G1/4, G3/8, G1/2	G1/4, G3/8, G1/2, G3/4	-	-	-	■	■	-	-	-	■	■
	9	-	-	-	-	-	-	-	-	-	-	-	-
	12	-	-	-	-	-	-	-	-	-	-	-	-
Service unit combinations (further variants can be ordered using the configurator → Internet: msb4, msb6 or msb9)													
MSB 	4	G1/4	G1/8, G1/4, G3/8	-	-	-	■	■	-	-	-	■	■
	6	G1/2	G1/4, G3/8, G1/2, G3/4	-	-	-	■	■	-	-	-	■	■
	9	-	-	-	-	-	-	-	-	-	-	-	-
	12	-	-	-	-	-	-	-	-	-	-	-	-
Individual devices													
Filter regulators MS-LFR 	4	G1/8, G1/4	G1/8, G1/4, G3/8	-	-	■	■	■	-	-	-	■	■
	6	G1/4, G3/8, G1/2	G1/4, G3/8, G1/2, G3/4	-	-	■	■	■	■	-	-	■	■
	9	G3/4, G1	G1/2, G3/4, G1, G1 1/4, G1 1/2	-	-	■	■	■	■	-	-	■	■
	12	-	G1, G1 1/4, G1 1/2, G2	-	-	-	■	■	■	-	-	■	■
Filters MS-LF 	4	G1/8, G1/4	G1/8, G1/4, G3/8	-	-	-	-	-	-	-	-	■	■
	6	G1/4, G3/8, G1/2	G1/4, G3/8, G1/2, G3/4	-	-	-	-	-	-	-	-	■	■
	9	G3/4, G1	G1/2, G3/4, G1, G1 1/4, G1 1/2	-	-	-	-	-	-	-	-	■	■
	12	-	G1, G1 1/4, G1 1/2, G2	-	-	-	-	-	-	-	-	■	■
Fine and micro filters MS-LFM 	4	G1/8, G1/4	G1/8, G1/4, G3/8	-	-	-	-	-	■	■	-	-	-
	6	G1/4, G3/8, G1/2	G1/4, G3/8, G1/2, G3/4	-	-	-	-	-	■	■	-	-	-
	9	G3/4, G1	G1/2, G3/4, G1, G1 1/4, G1 1/2	-	-	-	-	-	■	■	-	-	-
	12	-	G1, G1 1/4, G1 1/2, G2	-	-	-	-	-	■	■	-	-	-
Activated carbon filters MS-LFX 	4	G1/8, G1/4	G1/8, G1/4, G3/8	-	-	-	-	-	-	-	-	-	-
	6	G1/4, G3/8, G1/2	G1/4, G3/8, G1/2, G3/4	-	-	-	-	-	-	-	-	-	-
	9	G3/4, G1	G1/2, G3/4, G1, G1 1/4, G1 1/2	-	-	-	-	-	-	-	-	-	-
	12	-	G1, G1 1/4, G1 1/2, G2	-	-	-	-	-	-	-	-	-	-
Water separators MS-LWS 	4	-	-	-	-	-	-	-	-	-	-	-	-
	6	G1/4, G3/8, G1/2	G1/4, G3/8, G1/2, G3/4	-	-	-	-	-	-	-	-	-	-
	9	G3/4, G1	G1/2, G3/4, G1, G1 1/4, G1 1/2	-	-	-	-	-	-	-	-	-	-
	12	-	G1, G1 1/4, G1 1/2, G2	-	-	-	-	-	-	-	-	-	-

Membrane air dryers MS-LDM1, MS series

Product range overview – MS series service units

Type	Size	Bowl guard		Condensate drains				Pressure indicator				Security		Options		→ Page/ Internet	
		Plastic bowl with plastic bowl guard	Metal bowl	Manual rotary	Semi-automatic	Fully automatic	External, fully automatic, electrical	Cover plate (without pressure gauge)	Integrated MS pressure gauge	Adapter plate for EN pressure gauge G1/8	Adapter plate for EN pressure gauge G1/4	Pressure sensor	Rotary knob with detent, lockable via accessories	Rotary knob with integrated lock	Silencer		Flow direction from right to left
Code		R	U	M	H	V	E...	VS	AG	A8	A4	AD...	AS	E11	S	Z	
Service units																	
MSB-FRC	4	■	-	■	-	■	-	-	■	-	-	-	■	-	-	■	msb4
	6	■	■	■	-	■	-	-	■	-	-	-	■	-	-	■	msb6
	9	-	-	-	-	-	-	-	-	-	-	-	-	-	-	-	-
	12	-	-	-	-	-	-	-	-	-	-	-	-	-	-	-	-
Service unit combinations																	
MSB	4	■	■	■	-	■	-	-	■	-	-	-	■	-	-	■	msb4
	6	■	■	■	-	■	-	-	■	-	-	-	■	-	-	■	msb6
	9	-	-	-	-	-	-	-	-	-	-	-	-	-	-	-	-
	12	-	-	-	-	-	-	-	-	-	-	-	-	-	-	-	-
Individual devices																	
Filter regulators MS-LFR	4	■	■	■	■	■	-	■	■	■	■	■	■	■	-	■	ms4-lfr
	6	■	■	■	■	■	■	■	■	■	■	■	■	■	-	■	ms6-lfr
	9	-	■	■	■	■	■	■	■	■	■	■	■	■	-	■	ms9-lfr
	12	-	■	■	-	■	■	■	■	■	■	■	■	■	-	■	ms12-lfr
Filters MS-LF	4	■	■	■	■	■	-	-	-	-	-	-	-	-	-	■	ms4-lf
	6	■	■	■	■	■	■	-	-	-	-	-	-	-	-	■	ms6-lf
	9	-	■	■	■	■	■	-	-	-	-	-	-	-	-	■	ms9-lf
	12	-	■	■	-	■	■	-	-	-	-	-	-	-	-	■	ms12-lf
Fine and micro filters MS-LFM	4	■	■	■	■	■	-	-	-	-	-	-	-	-	-	■	ms4-lfm
	6	■	■	■	■	■	■	-	-	-	-	-	-	-	-	■	ms6-lfm
	9	-	■	■	■	■	■	-	-	-	-	-	-	-	-	■	ms9-lfm
	12	-	■	■	-	■	■	-	-	-	-	-	-	-	-	■	ms12-lfm
Activated carbon filters MS-LFX	4	■	■	-	-	-	-	-	-	-	-	-	-	-	-	■	ms4-lfx
	6	■	■	-	-	-	-	-	-	-	-	-	-	-	-	■	ms6-lfx
	9	-	■	-	-	-	-	-	-	-	-	-	-	-	-	■	ms9-lfx
	12	-	■	-	-	-	-	-	-	-	-	-	-	-	-	■	ms12-lfx
Water separators MS-LWS	4	-	-	-	-	-	-	-	-	-	-	-	-	-	-	-	-
	6	-	■	-	-	■	■	-	-	-	-	-	-	-	-	■	ms6-lws
	9	-	■	-	-	■	■	-	-	-	-	-	-	-	-	■	ms9-lws
	12	-	■	-	-	■	■	-	-	-	-	-	-	-	-	■	ms12-lws

Membrane air dryers MS-LDM1, MS series

Product range overview – MS series service units



Type	Size	Pneumatic connection in housing	Connecting plate	Pressure regulation range [bar]								Supply voltage			
				0.05 ... 0.7	0.05 ... 2.5	0.1 ... 4	0.3 ... 7	0.1 ... 12	0.5 ... 16	24 V DC, connection pattern to EN 175301	24 V DC, connection M12 to IEC 61076-2-101	110 V AC, connection pattern to EN 175301	230 V AC, connection pattern to EN 175301		
Code			AG...	D2	D4	D5	D6	D7	D8	V24	V24P	V110	V230		
Individual devices															
Pressure regulators MS-LR		4	G1/8, G1/4	G1/8, G1/4, G3/8	-	-	■	■	■	-	-	-	-		
		6	G1/4, G3/8, G1/2	G1/4, G3/8, G1/2, G3/4	-	-	■	■	■	■	-	-	-		
		9	G3/4, G1	G1/2, G3/4, G1, G1 1/4, G1 1/2	-	-	■	■	■	■	-	-	-		
		12	-	G1, G1 1/4, G1 1/2, G2	-	-	-	■	■	■	-	-	-		
Pressure regulators MS-LRB		4	G1/4	G1/8, G1/4, G3/8	-	-	■	■	■	-	-	-	-		
		6	G1/2	G1/4, G3/8, G1/2, G3/4	-	-	■	■	■	■	-	-	-		
		9	-	-	-	-	-	-	-	-	-	-	-		
		12	-	-	-	-	-	-	-	-	-	-	-		
Precision pressure regulators MS-LRP		4	-	-	-	-	-	-	-	-	-	-	-		
		6	G1/4, G3/8, G1/2	G1/4, G3/8, G1/2, G3/4	■	■	■	-	■	-	-	-	-		
		9	-	-	-	-	-	-	-	-	-	-	-		
		12	-	-	-	-	-	-	-	-	-	-	-		
Precision pressure regulators MS-LRPB		4	-	-	-	-	-	-	-	-	-	-	-		
		6	G1/2	G1/4, G3/8, G1/2, G3/4	■	■	■	-	■	-	-	-	-		
		9	-	-	-	-	-	-	-	-	-	-	-		
		12	-	-	-	-	-	-	-	-	-	-	-		
Electrical pressure regulators MS-LRE		4	-	-	-	-	-	-	-	-	-	-	-		
		6	G1/4, G3/8, G1/2	G1/4, G3/8, G1/2, G3/4	-	-	■	■	■	■	-	-	-		
		9	-	-	-	-	-	-	-	-	-	-	-		
		12	-	-	-	-	-	-	-	-	-	-	-		
Lubricators MS-LOE		4	G1/8, G1/4	G1/8, G1/4, G3/8	-	-	-	-	-	-	-	-	-		
		6	G1/4, G3/8, G1/2	G1/4, G3/8, G1/2, G3/4	-	-	-	-	-	-	-	-	-		
		9	G3/4, G1	G1/2, G3/4, G1, G1 1/4, G1 1/2	-	-	-	-	-	-	-	-	-		
		12	-	G1, G1 1/4, G1 1/2, G2	-	-	-	-	-	-	-	-	-		
On-off valves, manually actuated MS-EM(1)		4	G1/8, G1/4	G1/8, G1/4, G3/8	-	-	-	-	-	-	-	-	-		
		6	G1/4, G3/8, G1/2	G1/4, G3/8, G1/2, G3/4	-	-	-	-	-	-	-	-	-		
		9	G3/4, G1	G1/2, G3/4, G1, G1 1/4, G1 1/2	-	-	-	-	-	-	-	-	-		
		12	-	G1, G1 1/4, G1 1/2, G2	-	-	-	-	-	-	-	-	-		
On-off valves, electrically actuated MS-EE		4	G1/8, G1/4	G1/8, G1/4, G3/8	-	-	-	-	-	-	■	-	■		
		6	G1/4, G3/8, G1/2	G1/4, G3/8, G1/2, G3/4	-	-	-	-	-	-	■	-	■		
		9	G3/4, G1	G1/2, G3/4, G1, G1 1/4, G1 1/2	-	-	-	-	-	-	■	■	■		
		12	-	G1, G1 1/4, G1 1/2, G2	-	-	-	-	-	-	■	■	■		
Soft-start valves, pneumatically actuated MS-DL		4	G1/8, G1/4	G1/8, G1/4, G3/8	-	-	-	-	-	-	-	-	-		
		6	G1/4, G3/8, G1/2	G1/4, G3/8, G1/2, G3/4	-	-	-	-	-	-	-	-	-		
		9	-	-	-	-	-	-	-	-	-	-	-		
		12	-	G1, G1 1/4, G1 1/2, G2	-	-	-	-	-	-	-	-	-		
Soft-start valves, electrically actuated MS-DE		4	G1/8, G1/4	G1/8, G1/4, G3/8	-	-	-	-	-	-	■	-	■		
		6	G1/4, G3/8, G1/2	G1/4, G3/8, G1/2, G3/4	-	-	-	-	-	-	■	-	■		
		9	-	-	-	-	-	-	-	-	-	-	-		
		12	-	G1, G1 1/4, G1 1/2, G2	-	-	-	-	-	-	■	■	■		

Membrane air dryers MS-LDM1, MS series

Product range overview – MS series service units

Type	Size	Bowl guard		Pressure indicator				Security			Options		→ Page/ Internet
		Plastic bowl with plastic bowl guard	Metal bowl	Cover plate (without pressure gauge)	Integrated MS pressure gauge	Adapter plate for EN pressure gauge G1/8	Adapter plate for EN pressure gauge G1/4	Pressure sensor	Rotary knob with detent, lockable via accessories	Rotary knob with integrated lock	Silencer	Flow direction from right to left	
Code		R	U	VS	AG	A8	A4	AD...	AS	E11	S	Z	
Individual devices													
Pressure regulators MS-LR	4	-	-	■	■	■	■	■	■	■	-	■	ms4-lr
	6	-	-	■	■	-	■	■	■	■	-	■	ms6-lr
	9	-	-	■	■	-	■	■	■	■	-	■	ms9-lr
	12	-	-	■	■	-	■	-	■	■	-	■	ms12-lr
Pressure regulators MS-LRB	4	-	-	■	■	■	■	■	■	■	-	■	ms4-lrb
	6	-	-	■	■	-	■	■	■	■	-	■	ms6-lrb
	9	-	-	-	-	-	-	-	-	-	-	-	-
	12	-	-	-	-	-	-	-	-	-	-	-	-
Precision pressure regulators MS-LRP	4	-	-	-	-	-	-	-	-	-	-	-	-
	6	-	-	■	-	■	■	■	■	■	-	■	ms6-lrp
	9	-	-	-	-	-	-	-	-	-	-	-	-
	12	-	-	-	-	-	-	-	-	-	-	-	-
Precision pressure regulators MS-LRPB	4	-	-	-	-	-	-	-	-	-	-	-	-
	6	-	-	■	-	■	■	■	■	■	-	■	ms6-lrpb
	9	-	-	-	-	-	-	-	-	-	-	-	-
	12	-	-	-	-	-	-	-	-	-	-	-	-
Electrical pressure regulators MS-LRE	4	-	-	-	-	-	-	-	-	-	-	-	-
	6	-	-	■	■	-	■	-	-	-	-	■	ms6-lre
	9	-	-	-	-	-	-	-	-	-	-	-	-
	12	-	-	-	-	-	-	-	-	-	-	-	-
Lubricators MS-LOE	4	■	■	-	-	-	-	-	-	-	-	■	ms4-loe
	6	■	■	-	-	-	-	-	-	-	-	■	ms6-loe
	9	-	■	-	-	-	-	-	-	-	-	■	ms9-loe
	12	-	■	-	-	-	-	-	-	-	-	■	ms12-loe
On-off valves, manually actuated MS-EM(1)	4	-	-	■	■	■	■	■	-	-	■	■	ms4-em1
	6	-	-	■	■	-	■	■	-	-	■	■	ms6-em1
	9	-	-	■	■	-	■	-	-	-	■	■	ms9-em
	12	-	-	■	■	-	■	-	-	-	■	■	ms12-em
On-off valves, electrically actuated MS-EE	4	-	-	■	■	■	■	■	-	-	■	■	ms4-ee
	6	-	-	■	■	-	■	■	-	-	■	■	ms6-ee
	9	-	-	■	■	-	■	-	-	-	■	■	ms9-ee
	12	-	-	■	■	-	■	-	-	-	■	■	ms12-ee
Soft-start valves, pneumatically actuated MS-DL	4	-	-	■	■	■	■	■	-	-	-	■	ms4-dl
	6	-	-	■	■	-	■	■	-	-	-	■	ms6-dl
	9	-	-	-	-	-	-	-	-	-	-	-	-
	12	-	-	■	■	-	■	-	-	-	-	■	ms12-dl
Soft-start valves, electrically actuated MS-DE	4	-	-	■	■	■	■	■	-	-	-	■	ms4-de
	6	-	-	■	■	-	■	■	-	-	-	■	ms6-de
	9	-	-	-	-	-	-	-	-	-	-	-	-
	12	-	-	■	■	-	■	-	-	-	-	■	ms12-de

Membrane air dryers MS-LDM1, MS series

Product range overview – MS series service units



Type	Size	Pneumatic connection in housing	Connecting plate	Performance Level		Supply voltage				
				Category 1, 1-channel	Category 4, 2-channel with self-monitoring	24 V DC, connection pattern to EN 175301	24 V DC, connection M12 to IEC 61076-2-101 / to EN 60947-5-2	110 V AC, connection pattern to EN 175301	230 V AC, connection pattern to EN 175301	
Code			AG...	C	E	V24	V24P	V110	V230	
Individual devices										
Soft start and exhaust valves MS-SV-C		4	–							
		6	G $\frac{1}{2}$	G $\frac{1}{4}$, G $\frac{3}{8}$, G $\frac{1}{2}$, G $\frac{3}{4}$	■	–	■	■	■	■
		9	G $\frac{3}{4}$, G1	G $\frac{1}{2}$, G $\frac{3}{4}$, G1, G1 $\frac{1}{4}$, G1 $\frac{1}{2}$	■	–	■	■	■	■
		12	–							
Soft start and exhaust valves MS-SV-E		4	–							
		6	G $\frac{1}{2}$	G $\frac{1}{4}$, G $\frac{3}{8}$, G $\frac{1}{2}$, G $\frac{3}{4}$	–	■	■	–	–	–
		9	–							
		12	–							
Membrane air dryers MS-LDM1		4	G $\frac{1}{8}$, G $\frac{1}{4}$	G $\frac{1}{8}$, G $\frac{1}{4}$, G $\frac{3}{8}$	–	–	–	–	–	–
		6	G $\frac{1}{4}$, G $\frac{3}{8}$, G $\frac{1}{2}$	G $\frac{1}{4}$, G $\frac{3}{8}$, G $\frac{1}{2}$, G $\frac{3}{4}$	–	–	–	–	–	–
		9	–							
		12	–							
Branching modules MS-FRM		4	G $\frac{1}{8}$, G $\frac{1}{4}$	G $\frac{1}{8}$, G $\frac{1}{4}$, G $\frac{3}{8}$	–	–	–	–	–	–
		6	G $\frac{1}{4}$, G $\frac{3}{8}$, G $\frac{1}{2}$	G $\frac{1}{4}$, G $\frac{3}{8}$, G $\frac{1}{2}$, G $\frac{3}{4}$	–	–	–	–	–	–
		9	G $\frac{3}{4}$, G1	G $\frac{1}{2}$, G $\frac{3}{4}$, G1, G1 $\frac{1}{4}$, G1 $\frac{1}{2}$	–	–	–	–	–	–
		12	–	G1, G1 $\frac{1}{4}$, G1 $\frac{1}{2}$, G2	–	–	–	–	–	–
Distributor blocks MS-FRM-FRZ		4	G $\frac{1}{4}$	–	–	–	–	–	–	
		6	G $\frac{1}{2}$	–	–	–	–	–	–	
		9	–							
		12	–							
Flow sensors SFAM		4	–							
		6	G $\frac{1}{2}$	G $\frac{1}{2}$	–	–	–	–	–	–
		9	–	G1, G1 $\frac{1}{2}$	–	–	–	–	–	–
		12	–							

Membrane air dryers MS-LDM1, MS series

Product range overview – MS series service units

Type	Size	Bowl guard		Pressure indicator					Switch output			Options		→ Page/ Internet
		Plastic bowl with plastic bowl guard	Metal bowl	Cover plate (without pressure gauge)	Integrated MS pressure gauge	Adapter plate for EN pressure gauge G1/8	Adapter plate for EN pressure gauge G1/4	Pressure sensor	2x PNP or NPN, 1 analogue output 4 ... 20 mA	2x PNP or NPN, 1 analogue output 0 ... 10 V	Silencer	Flow direction from right to left		
Code		R	U	VS	AG	A8	A4	AD...	2SA	2SV	S	Z/R		
Individual devices														
Soft start and exhaust valves MS-SV-C	4	-												-
	6	-	-	■	■	-	■	■	-	-	■	■		ms6-sv
	9	-	-	■	■	-	■	■	-	-	■	■		ms9-sv
	12	-												-
Soft start and exhaust valves MS-SV-E	4	-												-
	6	-	-	■	■	-	■	■	-	-	■	■		ms6-sv
	9	-												-
	12	-												-
Membrane air dryers MS-LDM1	4	-	■	-	-	-	-	-	-	-	-	■		8
	6	-	■	-	-	-	-	-	-	-	-	■		8
	9	-												-
	12	-												-
Branching modules MS-FRM	4	-	-	■	■	■	■	■	-	-	-	■		ms4-frm
	6	-	-	■	■	-	■	■	-	-	-	■		ms6-frm
	9	-	-	■	■	-	■	■	-	-	-	■		ms9-frm
	12	-	-	■	-	-	-	-	-	-	-	-		ms12-frm
Distributor blocks MS-FRM-FRZ	4	-	-	-	-	-	-	-	-	-	-	■		ms4-frm
	6	-	-	-	-	-	-	-	-	-	-	■		ms6-frm
	9	-												-
	12	-												-
Flow sensors SFAM	4	-												-
	6	-	-	-	-	-	-	-	■	■	-	■		sfam-62
	9	-	-	-	-	-	-	-	■	■	-	■		sfam-90
	12	-												-

New
Variant EX4, UL1

Membrane air dryers MS4/MS6-LDM1, MS series

Peripherals overview

FESTO

Membrane air dryers MS4/MS6-LDM1

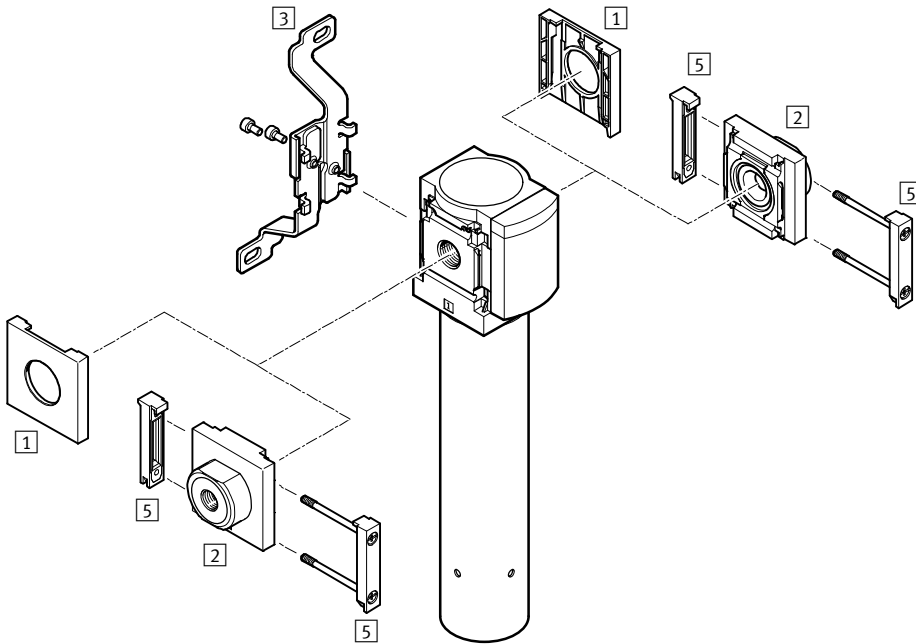

Note

Additional accessories:

- Module connector for combination with sizes MS4/MS6 or size MS9 → Internet: amv, rmv, armv
- Adapter plate for mounting on profiles → Internet: ipm-80, ipm-40-80, ipm-80-80

Mounting attachments and accessories						
		Individual unit		Combination		→ Page/Internet
		without connecting plate	with connecting plate	without connecting plate	with connecting plate	
1	Cover cap MS4/6-END	■	–	■	–	ms4-end, ms6-end
2	Connecting plate-SET MS4/6-AG...	–	■	–	■	ms4-ag, ms6-ag
3	Mounting bracket MS4/6-WB	■	■	–	–	ms4-wb, ms6-wb
5	Module connector MS4/6-MV	–	■	■	■	ms4-mv, ms6-mv
–	Mounting bracket MS4-WBM	■	■	–	–	ms4-wbm
–	Mounting bracket MS4/6-WP/WPB/WPE/WPM	–	■	■	■	ms4-wp, ms6-wp

Membrane air dryers MS4/MS6-LDM1, MS series

Type codes

		MS	6	-	LDM1	-	1/2	-	P20
Series									
MS	Standard service unit								
Size									
4	Grid dimension 40 mm								
6	Grid dimension 62 mm								
Service function									
LDM1	Membrane air dryer								
Pneumatic connection									
MS4									
1/4	Female thread G1/4								
MS6									
1/4	Female thread G1/4								
1/2	Female thread G1/2								
Flow cartridge									
MS4									
P10	Cartridge P10								
MS6									
P20	Cartridge P20								
P40	Cartridge P40								

Further variants can be ordered using the modular system → 15

- Female thread
- Connecting plates
- Flow cartridge
- Ducted purging air
- Type of mounting
- EU certification
- UL certification
- Flow direction

New
Variant EX4, UL1

Membrane air dryers MS4/MS6-LDM1, MS series

FESTO

Technical data

Function

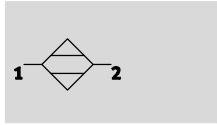

- - Flow rate
50 ... 400 l/min
- - Temperature range
+2 ... +50 °C
- - Operating pressure
3 ... 12.5 bar

Pressure dew point reduction:
20 K



- Optimum final dryer with excellent operational reliability
- Suitable for use as an individual unit or for integration in existing service unit combinations
- Flow rate-dependent dew point reduction
- Wear-free function requiring no external energy

- The composition of the compressed air remains almost unchanged due to the drying process
- 15% purge air flow rate
- Optional purge ring for ducting of purging air
- Optional device variant EX4 for use in potentially explosive areas in zones 1, 2, 21 and 22

Typical areas of application:

- Drying, cleaning of precision parts
- Measuring technology
- Rinsing of precision glass scales
- Painting systems
- Paper and packaging machines

Note

Prefiltration of the compressed air using a micro filter MS-LFM-A, grade of filtration 0.01 µm (residual particles < 0.1 µm, residual oil content < 0.1 mg/m³) is vital for flawless functioning of the unit.

General technical data					
Size	MS4		MS6		
Pneumatic connection 1, 2	G ¹ / ₈	G ¹ / ₄	G ¹ / ₄	G ³ / ₈	G ¹ / ₂
Design	Membrane dryer with internal air consumption				
Type of mounting	Via accessories				
	In-line installation				
Assembly position	Vertical ±5°				
Air purity class at the output	Compressed air in accordance with ISO 8573-1:2010 [1:3:2]				

Note: This product conforms to ISO 1179-1 and to ISO 228-1

Standard flow rate q _n ¹⁾ [l/min]					
Size	MS4		MS6		
	Cartridge P05	Cartridge P10	Cartridge P20	Cartridge P30	Cartridge P40
Input q _{n In}	59	118	235	353	471
Output q _{n Out}	50	100	200	300	400
Purge air q _{n Purge}	8.8	17.6	35.3	52.9	70.6

1) Measured at p₁ = 6.9 bar, θ_{pd In} = 25 °C, θ_{pd Out} = 5 °C ± 1.5 °C (θ_{pA Out} = -21.5 °C ± 1.2 °C), θ_{amb} = 25 °C

Membrane air dryers MS4/MS6-LDM1, MS series

Technical data

Operating and environmental conditions		
Operating pressure [bar]	3 ... 12.5 (3 ... 10) ¹⁾	
Operating medium	Compressed air in accordance with ISO 8573-1:2010 [1:4:2]	
Note on operating/pilot medium	Operation with lubricated medium not possible	
Pressure dew point reduction [K]	20	
Ambient temperature [°C]	+2 ... +50	
Temperature of medium [°C]	+2 ... +50	
Storage temperature [°C]	-20 ... +60	
Corrosion resistance class CRC ²⁾	2	
UL certification	cULus recognized (OL)	

1) Value in brackets applies to MS4/MS6-LDM1 with UL certification.

2) Corrosion resistance class CRC 2 to Festo standard FN 940070

Moderate corrosion stress. Indoor applications in which condensation may occur. External visible parts with primarily decorative requirements for the surface and which are in direct contact with the ambient atmosphere typical for industrial applications.

ATEX	
EU certification	EX4
ATEX category gas	II 2G
Ex-ignition protection type gas	c T6 X
ATEX category dust	II 2D
EX-ignition protection type dust	c 60 °C X
ATEX ambient temperature	+2 °C ≤ Ta ≤ +50 °C
CE mark (see declaration of conformity)	To EU Explosion Protection Directive (ATEX)

Weights [g]					
Size	MS4		MS6		
	Cartridge P05	Cartridge P10	Cartridge P20	Cartridge P30	Cartridge P40
Membrane air dryer	420	530	1,050	1,200	1,300

Materials

Sectional view

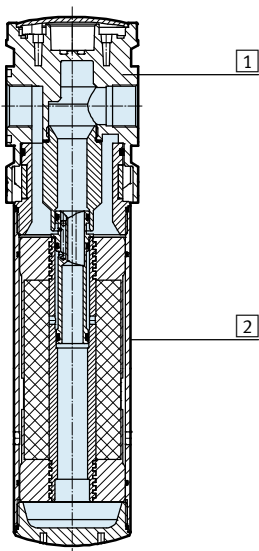

Membrane air dryer		
1	Housing	Die-cast aluminium
2	Bowl	Wrought aluminium alloy
-	Seals	NBR
Note on materials		RoHS-compliant

New
Variant EX4, UL1

Membrane air dryers MS4/MS6-LDM1, MS series

Technical data

FESTO

Pressure dew point t_{pd} (output) as a function of the standard flow rate at output q_n ¹⁾

MS4-LDM1-...-P05

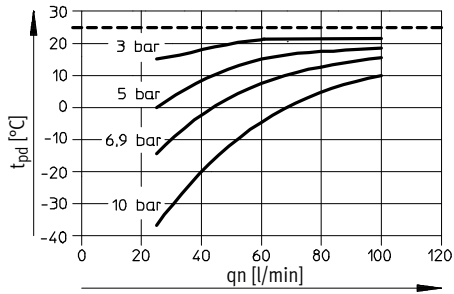

MS4-LDM1-...-P10

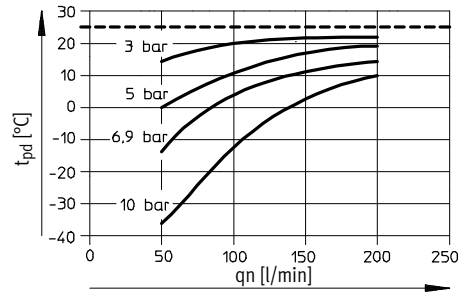

MS6-LDM1-...-P20

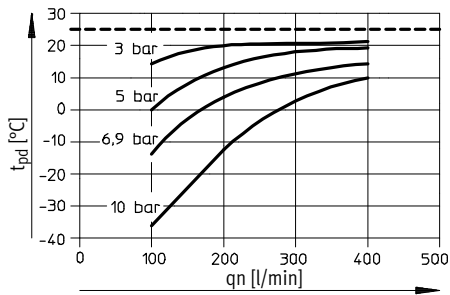

MS6-LDM1-...-P30

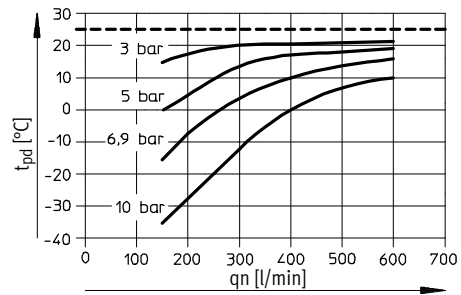

MS6-LDM1-...-P40

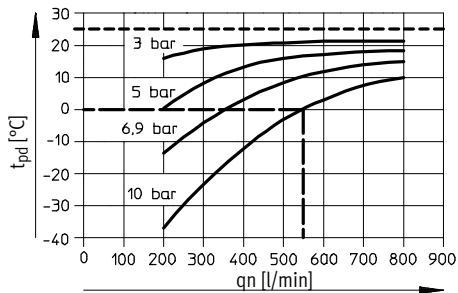

- 1) Measured at pressure dew point t_{pd} (supply) = 25 °C.
- Example MS6-LDM1-...-P40 with 10 bar operating pressure:
the pressure dew point reduction at a nominal flow rate
of $q_n = 550$ l/min is 25 K.

Membrane air dryers MS4/MS6-LDM1, MS series

Technical data

Differential pressure Δp as a function of the standard flow rate at output q_n

MS4-LDM1-...-P05

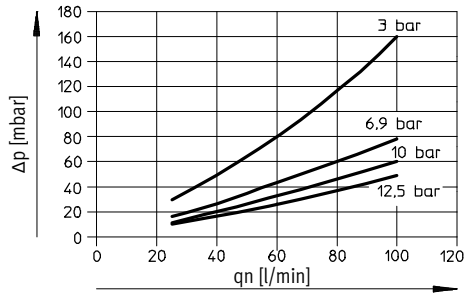

MS4-LDM1-...-P10

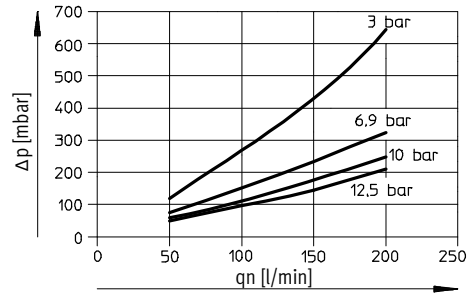

MS6-LDM1-...-P20

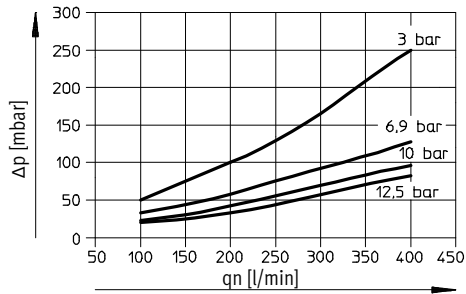

MS6-LDM1-...-P30

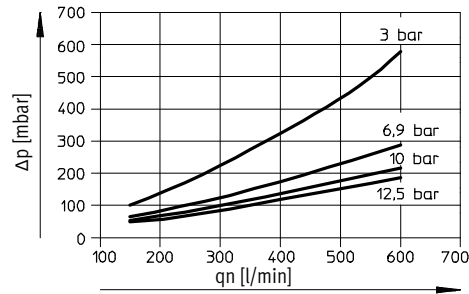

MS6-LDM1-...-P40

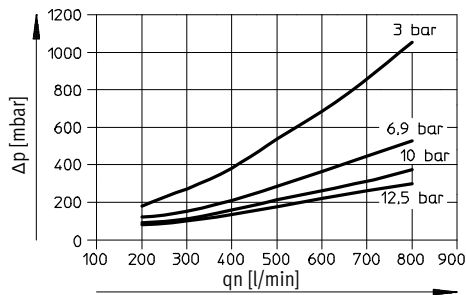

New
Variant EX4, UL1

Membrane air dryers MS4/MS6-LDM1, MS series

Technical data

FESTO

Dimensions

Download CAD data → www.festo.com

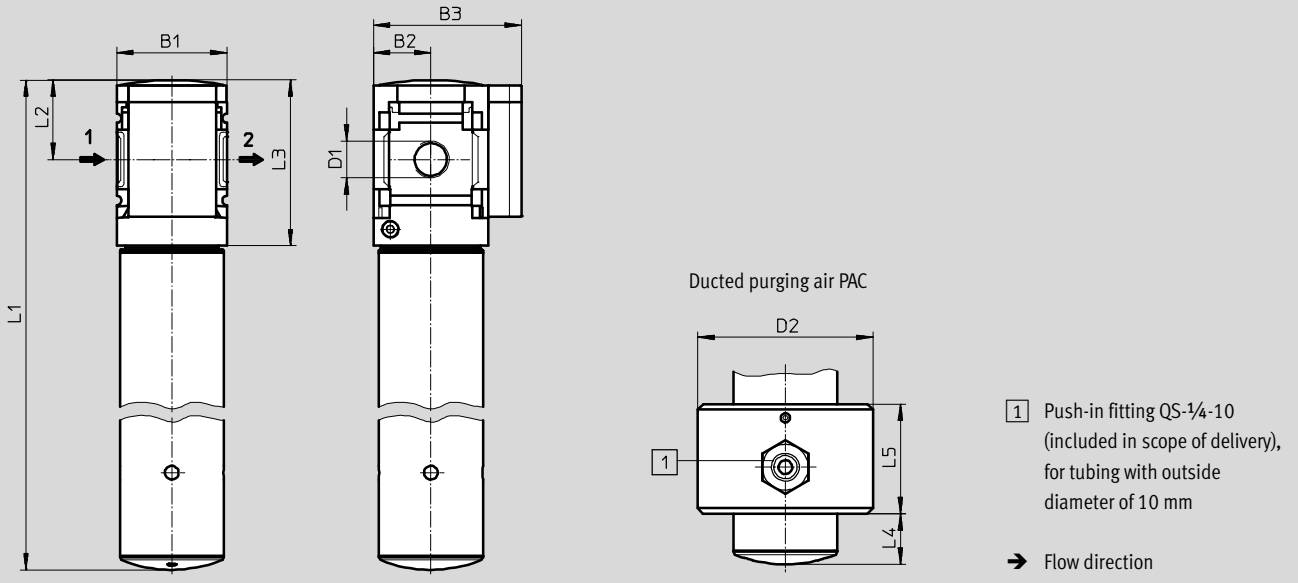

Type	B1	B2	B3	D1	D2	L1	L2	L3	L4	L5
MS4-LDM1-1/8-P05	40	21	54	G1/8	64	245	29	60	18	40
MS4-LDM1-1/8-P10						345				
MS4-LDM1-1/4-P05	40	21	54	G1/4	64	245	29	60	18	40
MS4-LDM1-1/4-P10						345				
MS6-LDM1-1/4-P20	62	31	76	G1/4	80	345	42	87	34	40
MS6-LDM1-1/4-P30						415				
MS6-LDM1-1/4-P40						475				
MS6-LDM1-3/8-P20	62	31	76	G3/8	80	345	42	87	34	40
MS6-LDM1-3/8-P30						415				
MS6-LDM1-3/8-P40						475				
MS6-LDM1-1/2-P20	62	31	76	G1/2	80	345	42	87	34	40
MS6-LDM1-1/2-P30						415				
MS6-LDM1-1/2-P40						475				

Note: This product conforms to ISO 1179-1 and to ISO 228-1

Ordering data

Size	Flow cartridge	Connection	Part No.	Type
MS4	P10	G1/4	543632	MS4-LDM1-1/4-P10
MS6	P20	G1/4	543640	MS6-LDM1-1/4-P20
		G1/2	543644	MS6-LDM1-1/2-P20
	P40	G1/2	543650	MS6-LDM1-1/2-P40

Membrane air dryers MS4/MS6-LDM1, MS series

Ordering data – Modular products

M Mandatory data						O Options				
Module No.	Series	Size	Function	Pneumatic connection	Flow cartridge	Purging air	Type of mounting	EU certification	UL certification	Flow direction
543628 543638	MS	4 6	LDM1	1/8, 1/4, 3/8, 1/2 AGA, AGB, AGC, AGD, AGE	P05 P10 P20 P30 P40	PAC	WP WPM WB WBM	EX4	UL1	Z
Ordering example										
543628	MS	4	- LDM1	- AGC	- P10	-	- WP	-	-	-

Ordering table										
Grid dimension	[mm]	40	62	Conditions	Code	Enter code				
M	Module No.	543628		543638						
	Series	Standard			MS	MS				
	Size	4	6		...					
	Function	Membrane dryer			-LDM1	-LDM1				
	Pneumatic connection	Female thread G1/8	-	1	-1/8					
		Female thread G1/4	Female thread G1/4	1	-1/4					
		-	Female thread G3/8	1	-3/8					
		-	Female thread G1/2	1	-1/2					
		Connecting plate G1/8	-		-AGA					
		Connecting plate G1/4	Connecting plate G1/4		-AGB					
		Connecting plate G3/8	Connecting plate G3/8		-AGC					
		-	Connecting plate G1/2		-AGD					
	Flow cartridge	50 l/min	-		-P05					
		100 l/min	-		-P10					
		-	200 l/min		-P20					
		-	300 l/min		-P30					
		-	400 l/min		-P40					
	O	Purging air	Ducted purging air		-PAC					
	Type of mounting	Wall mounting plate		2	-WP					
		Wall mounting plate		1 2	-WPM					
		Wall mounting bracket			-WB					
		Wall mounting bracket	-		-WBM					
	EU certification	II 2GD to EU Directive 94/9/EG			-EX4					
	UL certification	cULus, ordinary location for Canada and USA			-UL1					
	Flow direction	Flow direction from right to left			-Z					

1 1/8, 1/4, 3/8, 1/2, **WPM**

Not with EU certification EX4

2 **WP, WPM** Only with connecting plate AGA, AGB, AGC, AGD or AGE.

Transfer order code

	MS		- LDM1							
--	-----------	--	---------------	--	--	--	--	--	--	--