

## Valve terminal MPA-C

**FESTO**



## Valve terminal MPA-C

Key features

FESTO

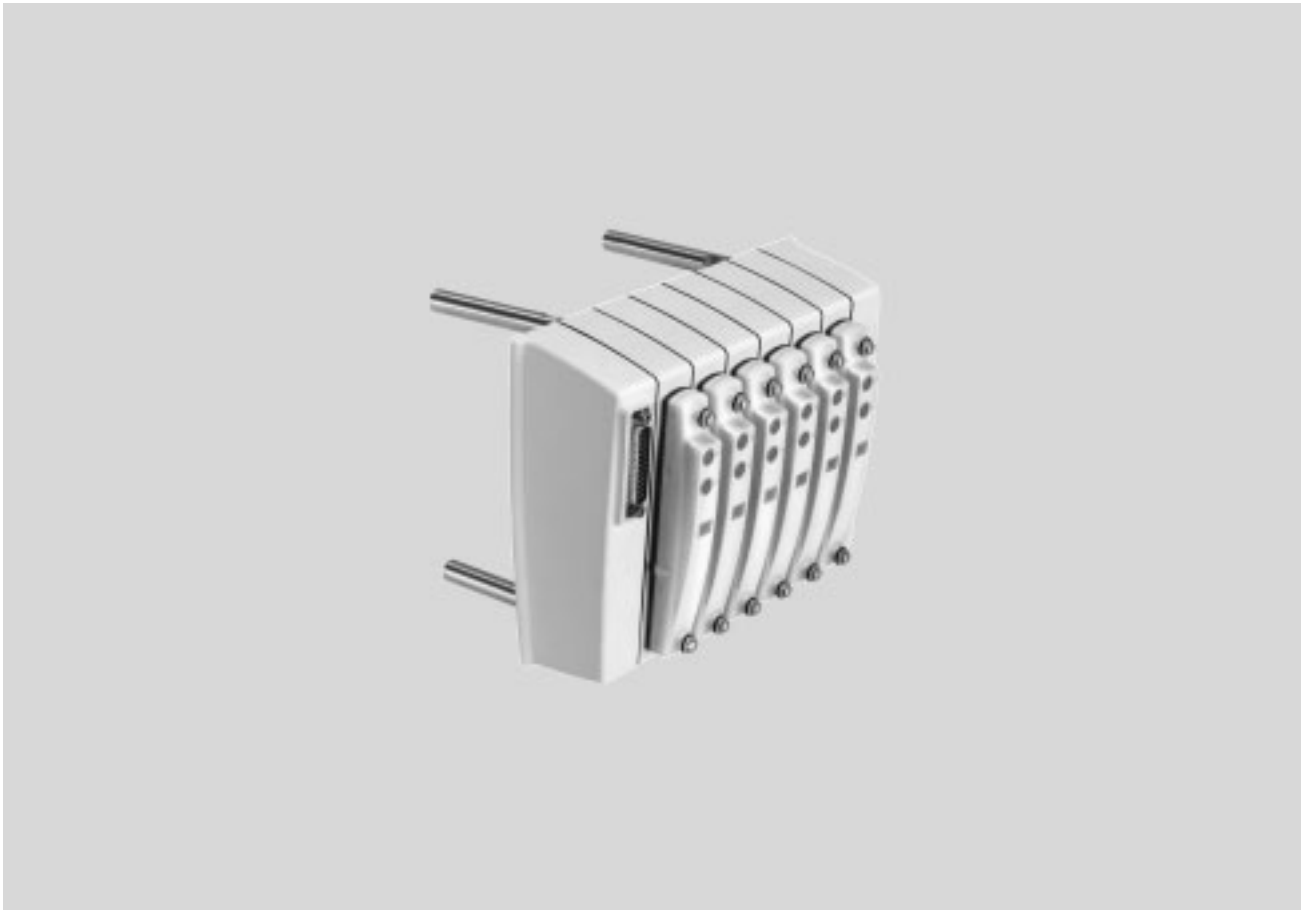

### Innovative

- Ideal housing surface design ensures that cleaning agents can run off, thus significantly reducing time and effort spent on cleaning
- Flow rate up to 780 l/min
- Sub-D multi-pin plug connection, front or rear
- I-Port interface/IO-Link, front or rear

### Versatile

- Valves in individual grid
- Freely extendable system with individual sub-bases and modular tie rods
- Up to 32 solenoid coils
- Easy subsequent conversion and extension
- Air supply can be extended using additional pressure zones with power supply modules or sub-bases with an additional power supply
- Wide pressure range  
–0.9 ... 8 bar
- Wide range of valve functions

### Reliable

- Use of materials that are resistant to corrosion and media
- Fast troubleshooting thanks to LEDs on the valves
- Easy to service thanks to replaceable valves
- Manual override, optionally non-detenting
- Efficient sealing thanks to 5 tie rods and redundant seals
- NSF-H1 greasing, FDA-compliant materials

### Easy to assemble

- Supplied as ready-to-assemble, inspected unit
- Individually configurable pneumatic connections (straight or angled fittings, or with screw-in thread)
- Reduced outlay on selection, ordering, assembly and commissioning
- Excellent corrosion resistance and degree of protection (IP69K) enable assembly under harsh ambient conditions outside of a control cabinet

# Valve terminal MPA-C

## Key features

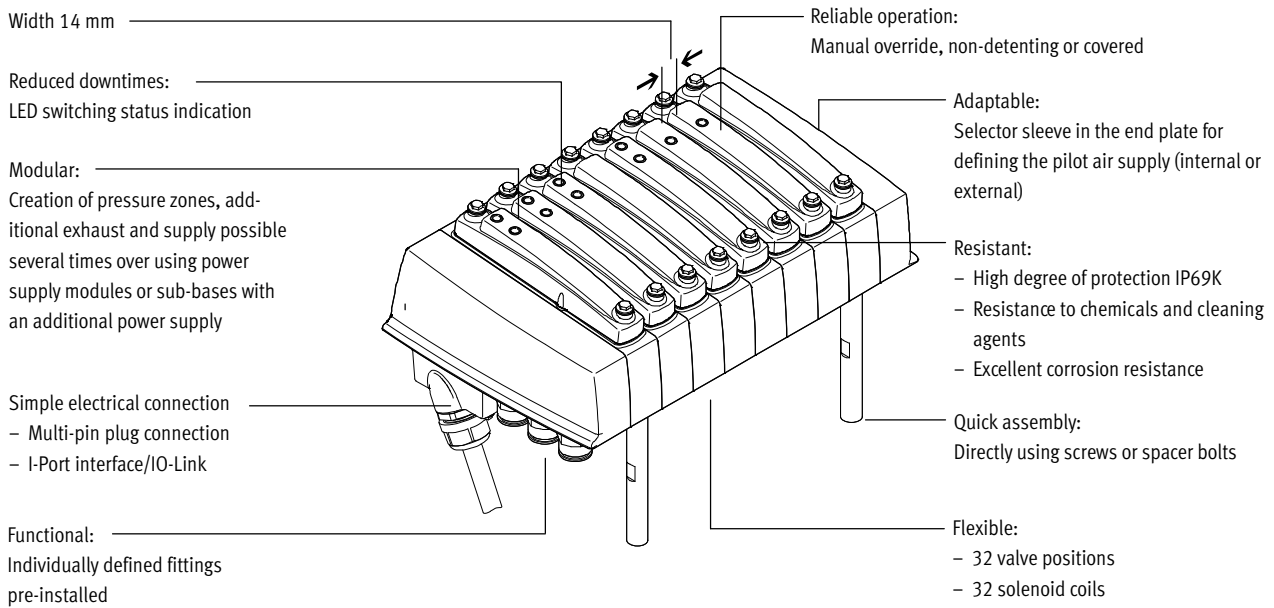

### Equipment options

#### Valve functions

- |  |  |   |  |
|--|--|---|--|
| <ul style="list-style-type: none"> <li>• 5/2-way valve, single solenoid</li> <li>• 5/2-way valve, double solenoid</li> <li>• 2x 3/2-way valve, normally open</li> <li>• 2x 3/2-way valve, normally closed</li> <li>• 2x 3/2-way valve, 1x normally open, 1x normally closed</li> </ul> | <ul style="list-style-type: none"> <li>• 5/3-way valve, mid-position pressurised</li> <li>• 5/3-way valve, mid-position closed</li> <li>• 5/3-way valve, mid-position exhausted</li> </ul> | <ul style="list-style-type: none"> <li>• 2x 2/2-way valve, 1x normally closed, 1x normally closed, reversible</li> <li>• 2x 2/2-way valve, normally closed</li> </ul> | <ul style="list-style-type: none"> <li>• 1x 3/2-way valve, normally closed, external compressed air supply</li> <li>• 1x 3/2-way valve, normally open, external compressed air supply</li> </ul> |
|--|--|---|--|

#### Special features

- |  |  |   |  |
|--|--|---|--|
| <ul style="list-style-type: none"> <li>• Maximum of 32 valve positions</li> <li>• Maximum of 32 solenoid coils</li> <li>• Parallel modular valve linking</li> <li>• Integrated reduction of holding current</li> </ul> | <ul style="list-style-type: none"> <li>• Any compressed air supply</li> <li>• Creating pressure zones</li> </ul> | <ul style="list-style-type: none"> <li>• Modular, individually extendable tie rods</li> <li>• Valve positions in individual grid</li> </ul> | <ul style="list-style-type: none"> <li>• Freely selectable fittings/tubing sizes at each port</li> </ul> |
|--|--|---|--|

### Valve terminal selection

#### Valve terminal configurator

The online catalogue is a quick and easy way to select an MPA-C valve terminal. This includes a convenient valve terminal configurator, making it much easier to order the right product.

The valve terminals are fully assembled according to your order specification and are individually checked. This reduces assembly and installation time to a minimum.

You can order an MPA-C valve terminal using the order code.

- MPA-C ordering system  
 → Internet: [mpac](http://mpac)  
 CTEU ordering system  
 → Internet: [cteu](http://cteu)

Online via: → [www.festo.com](http://www.festo.com)

#### 2D/3D CAD data

You can request the CAD data for a valve terminal you have configured. To do so, start the product search as described above. Go to the shopping basket and click on the CAD icon (compass). On the next page, you can generate a 3D preview or request a data format of your choice via e-mail.

# Valve terminal MPA-C

Key features

## Multi-pin plug connection

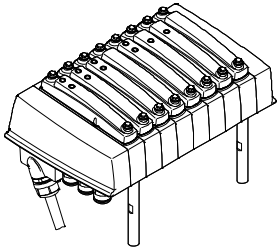

The signal flow from the controller to the valve terminal takes place via a pre-assembled or self-assembled multi-wire cable to the multi-pin plug connection, which substantially reduces installation time.

The valve terminal can be equipped with up to 32 solenoid coils. This corresponds to 2 to 32 valves.

Versions:

- Sub-D connection, 25-pin
- Sub-D connection, 44-pin

## I-Port interface/IO-Link

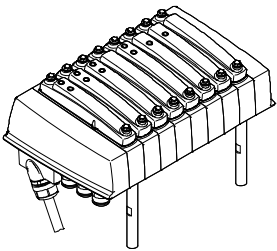

I-Port/IO-Link consists of a central master and the I-Port interface/IO-Link devices connected via special connecting cables. This permits a decentralised layout of the devices. The connection type corresponds to a star topology.

In other words, only one module or one valve terminal can be connected to each I-Port. The I-Port interface from Festo is based on IO-Link and is compatible with IO-Link in certain areas.

As well as communication, the I-Port interfaces also handle the power supply for the connected devices. The maximum length of a string is 20 m.

Versions:

- Sub-D connection, 9-pin

## Modular pneumatic components

The modular design of the MPA-C enables maximum flexibility right from the planning stage, and makes it exceptionally easy to service during operation.

The system consists of sub-bases, valves and blanking plates.

The sub-bases form the support system for the valves. They contain the connection ducts for supplying compressed air to and venting from the valve terminal as well as the working ports for the pneumatic drives for each valve.

The sub-bases are joined together via a tie rod system. This consists of a threaded rod, threaded sleeve and screw. The threaded rod/sleeve combination is selected as appropriate for the chosen number of individual bases.

A valve terminal can be easily extended by adding individual sub-bases or power supply modules. This is done by inserting suitable tie rod extenders between the threaded rod and the sleeve.

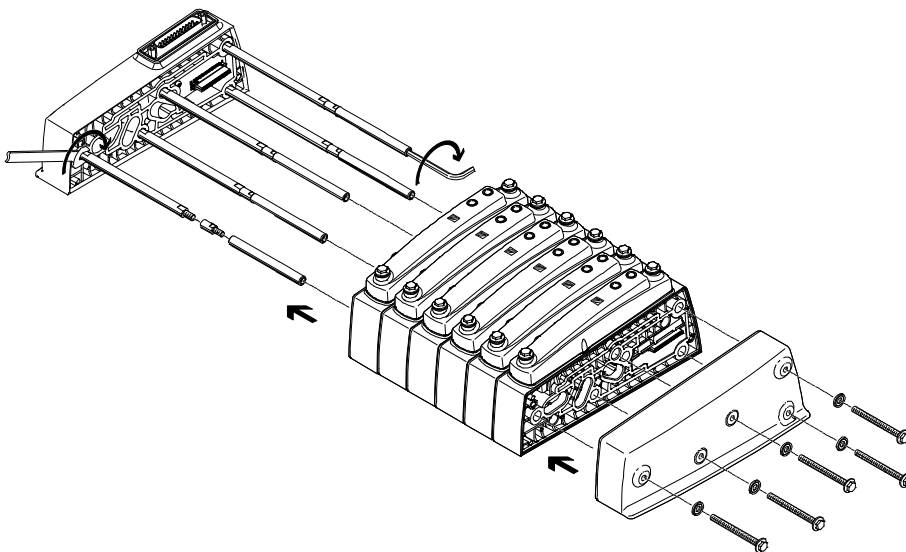

# Valve terminal MPA-C

Peripherals overview

## Valve terminal pneumatics

MPA-C valve terminals with multi-pin plug connection or I-Port interface/IO-Link can be expanded by up to 32 solenoid coils/valve positions.

Each individual sub-base is available with a valve position for valves with one or two solenoid coils.

Double solenoid valve positions can be equipped with any valve or a blanking plate.

Single solenoid valve positions can only be equipped with single solenoid valves or a blanking plate.

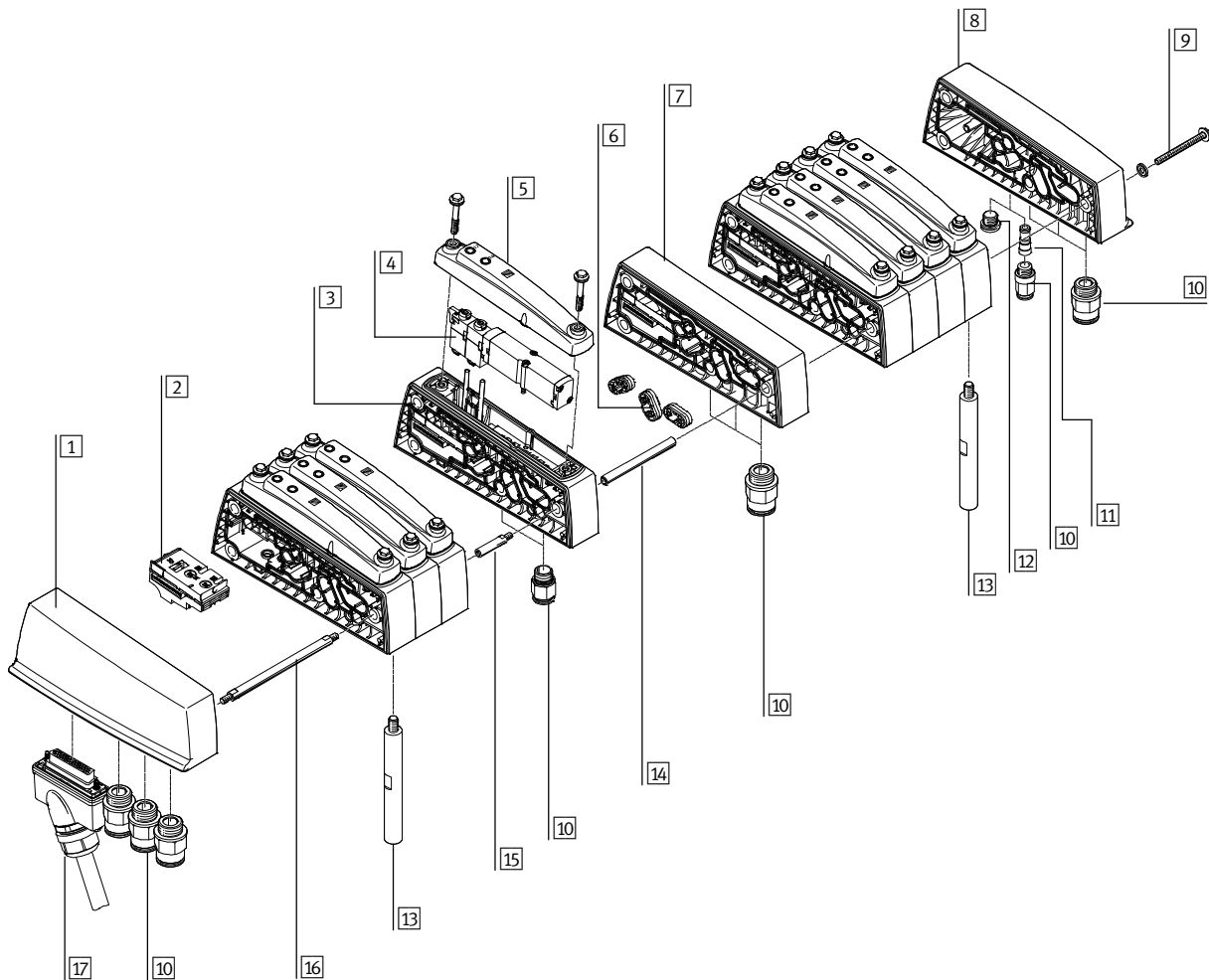

Description	Brief description	→ Page/Internet
1 Left-hand end plate	With connections for compressed air supply/exhaust air	31
2 Electrical interlinking module	Electrical interlinking module for single sub-base, single/double solenoid	–
3 Sub-base, individual	Sub-base with one valve position for valve with one or two solenoid coils	29
4 Solenoid valve	With one or two solenoid coils	29
5 Cover	For one valve position	29
6 Separator	For pressure zone separation	31
7 Power supply module	With connections for compressed air supply/exhaust air	31
8 Right-hand end plate	With connections for compressed air supply/exhaust air and external pilot air supply	31
9 Screw	Tie rod system, connects the sub-bases	30
10 Push-in fitting	For pneumatic connections	32
11 Plug	Enables conversion from internal to external pilot air supply	–
12 Blanking plug	For sealing ports that are not required	33
13 Mounting	Spacer bolts for mounting the valve terminal	31
14 Sleeve	Tie rod system, connects the sub-bases	30
15 Tie rod extender	For subsequent modular extension of the valve terminal	30
16 Threaded rod for tie rod	Clamps the sub-bases between the end plates	30
17 Connecting cable	For I-Port interface or for multi-pin plug connection	31, 31

# Valve terminal MPA-C

Key features – Pneumatic components

## Sub-base valve

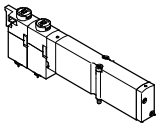

The MPA-C offers a comprehensive range of valve functions. All valves are equipped with a piston spool and patented sealing system that facilitates efficient sealing, a broad pressure range and a long service life. They have a pneumatic pilot control for optimising performance.

The air for this is supplied by means of a central pilot air supply. Sub-base valves can be replaced quickly since the tubing connections remain on the sub-base. This design is also particularly slim.

Whatever valve function is required, there are sub-base valves with one solenoid coil (monostable) or with two solenoid coils (bistable or two single solenoid valves in one housing).

## Design

### Valve replacement

The valves are located under the cover. The cover and each valve are mounted on the sub-base with two screws,

which means that they can be replaced easily. The sturdy mechanical structure of the cover and sub-bases ensures efficient, durable sealing.

### Extension

Vacant positions (blanking plates) can be replaced by valves at a later date. The dimensions, mounting points and existing pneumatic installations remain unchanged during this process.

The valve code (M, J, N, NS etc.) is located on the front of the valve, underneath the manual override, and can be read through a inspection window in the cover.



Note

A filter must be installed upstream of the valves operated in vacuum mode. This prevents any foreign matter in

the intake air getting into the valve (e.g. when operating a suction cup).

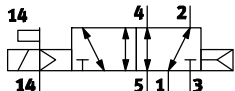
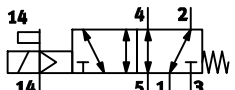
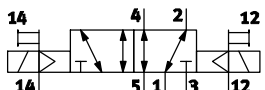
5/2-way valve		
Circuit symbol	Code	Description
	Position function 1-32: M	<ul style="list-style-type: none"> <li>• Single solenoid</li> <li>• Pneumatic spring return</li> <li>• Reversible</li> <li>• Operating pressure –0.9 ... +10 bar</li> </ul>
	Position function 1-32: MS	<ul style="list-style-type: none"> <li>• Single solenoid</li> <li>• Mechanical spring return</li> <li>• Reversible</li> <li>• Operating pressure –0.9 ... +8 bar</li> </ul>
	Position function 1-32: J	<ul style="list-style-type: none"> <li>• Double solenoid</li> <li>• Reversible</li> <li>• Operating pressure –0.9 ... +10 bar</li> </ul>

# Valve terminal MPA-C

Key features – Pneumatic components

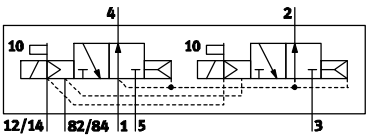
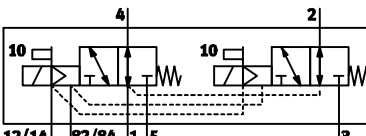
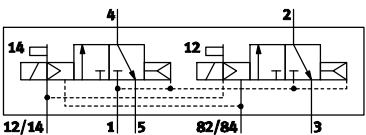
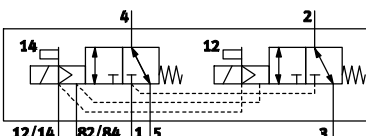
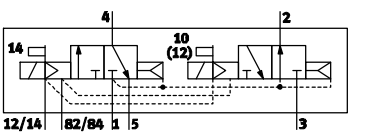
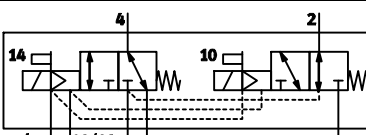
2x 3/2-way valve		
Circuit symbol	Code	Description
	Position function 1-32: N	<ul style="list-style-type: none"> <li>• Single solenoid</li> <li>• Normally open</li> <li>• Pneumatic spring return</li> <li>• Operating pressure 3 ... 10 bar</li> </ul>
	Position function 1-32: NS	<ul style="list-style-type: none"> <li>• Single solenoid</li> <li>• Normally open</li> <li>• Mechanical spring return</li> <li>• Reversible</li> <li>• Operating pressure -0.9 ... +8 bar</li> </ul>
	Position function 1-32: K	<ul style="list-style-type: none"> <li>• Single solenoid</li> <li>• Normally closed</li> <li>• Pneumatic spring return</li> <li>• Operating pressure 3 ... 10 bar</li> </ul>
	Position function 1-32: KS	<ul style="list-style-type: none"> <li>• Single solenoid</li> <li>• Normally closed</li> <li>• Mechanical spring return</li> <li>• Reversible</li> <li>• Operating pressure -0.9 ... +8 bar</li> </ul>
	Position function 1-32: H	<ul style="list-style-type: none"> <li>• Single solenoid</li> <li>• Normal position                             <ul style="list-style-type: none"> <li>- 1x closed</li> <li>- 1x open</li> </ul> </li> <li>• Pneumatic spring return</li> <li>• Operating pressure 3 ... 10 bar</li> </ul>
	Position function 1-32: HS	<ul style="list-style-type: none"> <li>• Single solenoid</li> <li>• Normal position                             <ul style="list-style-type: none"> <li>- 1x closed</li> <li>- 1x open</li> </ul> </li> <li>• Mechanical spring return</li> <li>• Reversible</li> <li>• Operating pressure -0.9 ... +8 bar</li> </ul>

# Valve terminal MPA-C

Key features – Pneumatic components

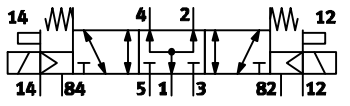
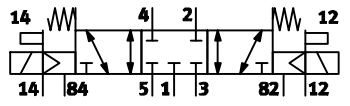
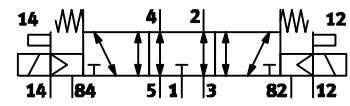
5/3-way valve		
Circuit symbol	Code	Description
	Position function 1-32: B	<ul style="list-style-type: none"> <li>• Mid-position pressurised<sup>1)</sup></li> <li>• Mechanical spring return</li> <li>• Reversible</li> <li>• Operating pressure –0.9 ... +10 bar</li> </ul>
	Position function 1-32: G	<ul style="list-style-type: none"> <li>• Mid-position closed<sup>1)</sup></li> <li>• Mechanical spring return</li> <li>• Reversible</li> <li>• Operating pressure –0.9 ... +10 bar</li> </ul>
	Position function 1-32: E	<ul style="list-style-type: none"> <li>• Mid-position exhausted<sup>1)</sup></li> <li>• Mechanical spring return</li> <li>• Reversible</li> <li>• Operating pressure –0.9 ... +10 bar</li> </ul>

1) If neither solenoid coil is energised, the valve assumes its mid-position by means of spring force.  
If both coils are energised at the same time, the valve remains in the switching position it had assumed previously.

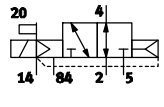
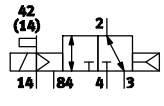
3/2-way valve		
Circuit symbol	Code	Description
	Position function 1-32: W	<ul style="list-style-type: none"> <li>• Single solenoid</li> <li>• Normally open</li> <li>• External compressed air supply</li> <li>• Pneumatic spring return</li> <li>• Reversible</li> <li>• Operating pressure –0.9 ... +10 bar</li> </ul> <p>The pressure supplied at working port 2 (–0.9 ... +10 bar) can be switched for both internal and external pilot air supplies.</p>
	Position function 1-32: X	<ul style="list-style-type: none"> <li>• Single solenoid</li> <li>• Normally closed</li> <li>• External compressed air supply</li> <li>• Pneumatic spring return</li> <li>• Reversible</li> <li>• Operating pressure –0.9 ... +10 bar</li> </ul> <p>The pressure supplied at working port 4 (–0.9 ... +10 bar) can be switched for both internal and external pilot air supplies.</p>

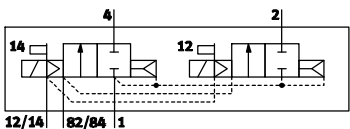
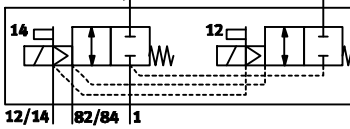
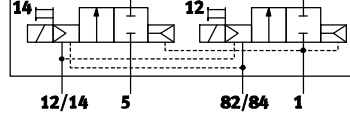
2x 2/2-way valve		
Circuit symbol	Code	Description
	Position function 1-32: D	<ul style="list-style-type: none"> <li>• Single solenoid</li> <li>• Normally closed</li> <li>• Pneumatic spring return</li> <li>• Operating pressure 3 ... 10 bar</li> </ul>
	Position function 1-32: DS	<ul style="list-style-type: none"> <li>• Single solenoid</li> <li>• Normally closed</li> <li>• Mechanical spring return</li> <li>• Reversible</li> <li>• Operating pressure –0.9 ... +8 bar</li> </ul>
	Position function 1-32: I	<ul style="list-style-type: none"> <li>• Single solenoid</li> <li>• 1x normally closed</li> <li>• 1x normally closed, only reversible</li> <li>• Pneumatic spring return</li> <li>• Operating pressure 3 ... 10 bar</li> <li>• Vacuum at port 3/5 only</li> </ul>



# Valve terminal MPA-C

Key features – Pneumatic components

## Cover plate

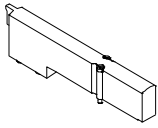

Vacant position (code L) without valve function, for reserving valve positions on a valve terminal.

The valve and vacant position are located under a cover.

Using a combination of a cover and a sub-base without a valve is not permissible unless a blanking plate is also being used.

## Compressed air supply and exhausting

The valve terminal MPA-C is supplied with compressed air via:

- Right-hand end plate
- Left-hand end plate
- Power supply modules
- Sub-bases with additional power supply

All pneumatic connections are located at the rear of the valve terminal.

Exhausting (ducts 3 and 5) can take place using a choice of:

- Right-hand end plate
- Left-hand end plate
- Power supply modules
- Sub-bases with additional power supply

Ducts 3 and 5 are routed completely separately in the terminal.

The pilot air exhaust (duct 82/84) is completely separate from ducts 3 and 5. Its port is located in the right-hand end plate, together with the ports for the pilot air supply (12/14) and the pressure compensation port (L).

All valves in the valve terminal are supplied by a common pilot air source, regardless of the pressure zones that are present.

The supply can take place using a choice of the following methods:

- Internal (from duct 1 on the right-hand end plate) or
- External (from duct 12/14)

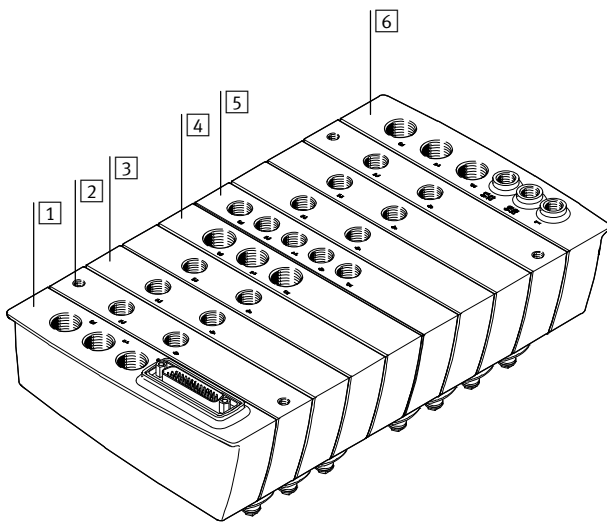

- 1 Left-hand end plate with electrical connection (multi-pin plug or I-Port interface/IO-Link) and pneumatic connections 1, 3 and 5
- 2 Sub-base with mounting holes and pneumatic connections 2 and 4
- 3 Sub-base without mounting holes and pneumatic connections 2 and 4

- 4 Power supply module with pneumatic connections 1, 3 and 5
- 5 Sub-base with additional power supply, with pneumatic connections 1, 3, 5 and 2, 4
- 6 Right-hand end plate with pneumatic connections 1, 3, 5 and L, 12/14, 82/84

 **Note**

If a gradual pressure build-up in the system using a soft-start valve is chosen, an external pilot air supply

should be connected so that the pilot pressure applied during switch-on is already very high.

# Valve terminal MPA-C

Key features – Pneumatic components

Compressed air supply and pilot air supply			
Graphical illustration	Code	Type	Notes
<b>Right-hand end plate</b>			
	Pilot air: Z	VMPAC-EPR-IN	<p>Internal pilot air supply</p> <ul style="list-style-type: none"> <li>• Pilot air is branched internally from port 1 in the right-hand end plate</li> <li>• For operating pressure in the range 3 ... 8 bar</li> <li>• Thread connection size G3/8 (port 1, port 3 and port 5)</li> <li>• Thread connection size G1/8 (port 82/84 and port L)</li> <li>• Blanking plug in port 12/14</li> </ul>
	Pilot air: –	VMPAC-EPR-EX	<p>External pilot air supply</p> <ul style="list-style-type: none"> <li>• Pilot air supply (3 ... 8 bar) is connected at port 12/14 on the right-hand end plate</li> <li>• For operating pressure in the range –0.9 ... 8 bar (suitable for vacuum)</li> <li>• Thread connection size G3/8 (port 1, port 3 and port 5)</li> <li>• Thread connection size G1/8 (port 12/14, 82/84 and port L)</li> </ul>
<b>Left-hand end plate</b>			
	Outlet, electrical connection: U	VMPAC-EPL...	<p>With electrical connection (multi-pin plug connection or I-Port interface/IO-Link) and pneumatic connections 1, 3 and 5:</p> <ul style="list-style-type: none"> <li>• Electrical connection, outlet direction at top</li> <li>• Electrical connection, outlet direction at bottom</li> <li>• Thread connection size G3/8</li> </ul>

# Valve terminal MPA-C

Key features – Pneumatic components

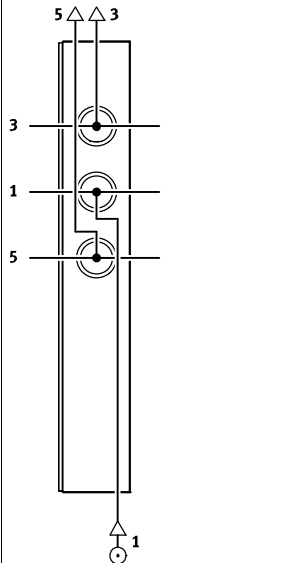
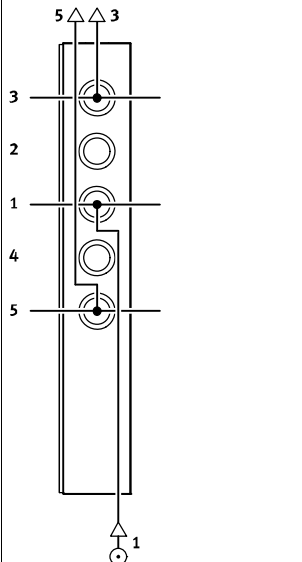
Compressed air supply and pilot air supply			
Graphical illustration	Code	Type	Notes
<b>Power supply module</b>			
	Type of module block 1-40: U	VMPAC-SP-0	<p>Additional power supply modules can be used for larger terminals or to create pressure zones.</p> <p>Supply modules can be configured at any point upstream or downstream of the sub-bases.</p> <p>Power supply modules contain the following ports:</p> <ul style="list-style-type: none"> <li>• Compressed air supply (port 1)</li> <li>• Exhaust air (port 3 and port 5)</li> <li>• Thread connection size G3/8</li> </ul>
<b>Sub-base, with additional power supply</b>			
	Sub-base with additional pneumatic power supply 01 - 40: PV	VMPAC-AP-14-SP...	<p>Sub-bases with an additional power supply can be used for larger terminals or to create pressure zones.</p> <p>Sub-bases with an additional power supply contain the following ports:</p> <ul style="list-style-type: none"> <li>• Compressed air supply (port 1)</li> <li>• Exhaust air (port 3 and port 5)</li> <li>• Thread connection size G1/4</li> </ul>

# Valve terminal MPA-C

Key features – Pneumatic components

## Creating pressure zones and separating exhaust air

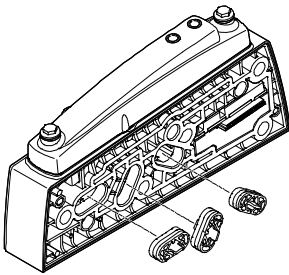

If different working pressure levels are required, the MPA-C offers a range of options for creating pressure zones. Duct 1 and/or duct 3 and/or duct 5 are blocked by inserting a separator in the sub-base. Each pressure zone must have its own supply. The following supply options are available:

- Left-hand end plate
- Right-hand end plate
- Power supply module

If you are using sub-bases with an additional power supply, each valve in the valve terminal could be operated within a separate pressure zone.

A pressure zone is created by separating the internal supply ducts using a special separator. Each pressure zone must have its own compressed air supply.

Compressed air can be supplied and exhausted via a supply module and/or the right-hand end plate.

The MPA-C allows you to select any

position for the power supply modules and the sub-bases with pressure zone separation.

The sub-bases with pressure zone separation are integrated into the terminal at the factory as specified in your order.

They can be distinguished by their coding, even when the valve terminal is assembled. Duct separation always takes place to the right of the sub-base.

## Example: Compressed air supply and pilot air supply

### External pilot air supply

The image opposite shows an example of creating and connecting an air supply in the case of an external pilot air supply.

The pilot air (duct 12/14) is supplied centrally to the entire valve terminal via the right-hand end plate.

Pressure zone separation always takes place to the right of the sub-base with separator(s).

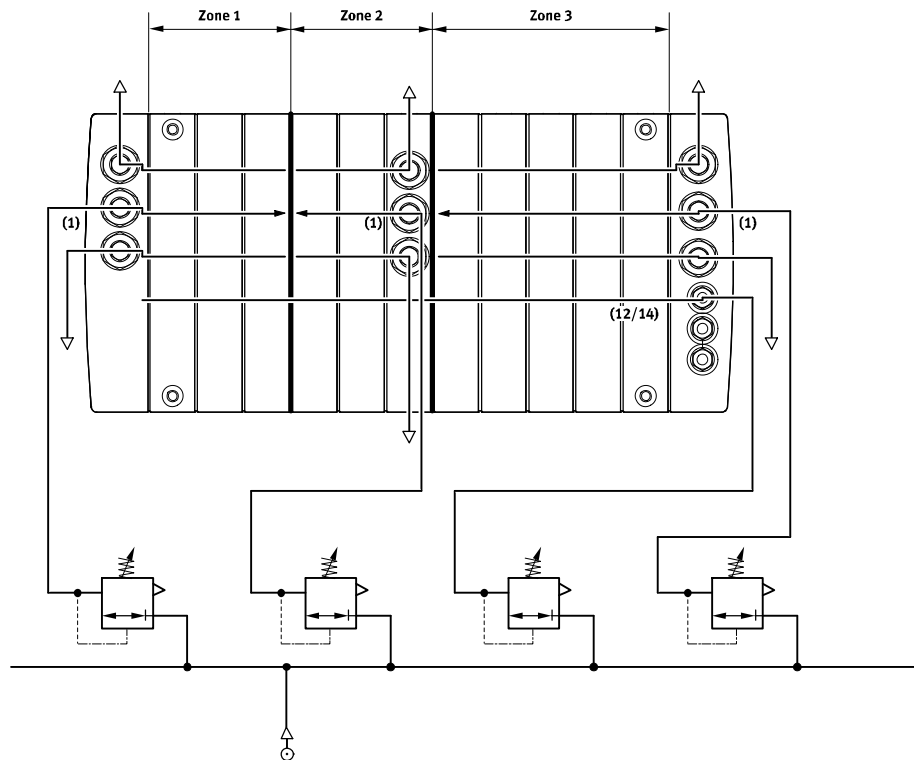

# Valve terminal MPA-C

Key features – Assembly

## Sub-base

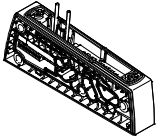

The MPA-C is based on a modular system consisting of sub-bases and valves. The sub-bases are joined together using tie rods and thus form the support system for the valves. They contain the connection ducts for supplying compressed air to and venting from the valve terminal as well as the working ports for the pneumatic drives for each valve. The sub-bases are joined together via tie rods. The tie rod consists of a

threaded rod, threaded sleeve and screw. In principle, sub-bases have a modular structure. The threaded rod/sleeve combination is selected according to the number and width of the individual sub-bases. To add further blocks, simply loosen the tie rod and adapt with extenders. There are no restrictions on extensions; a tie rod could be

constructed almost entirely from extenders. Each solenoid coil must be assigned to a specific pin of the multi-pin plug for the valve to be activated. Regardless of whether vacant positions or valves are used, sub-bases occupy:

- One coil/address (single solenoid valves)
- Two coils/addresses (double solenoid valves)

## Valve terminal assembly

Sub-bases with threaded holes are available for the MPA-C valve terminal. Therefore, the valve terminal can be assembled either in a control cabinet or on any even surface using spacer bolts.

It can be assembled in any position. However, the selected mounting position should allow dirt to be cleaned off and cleaning agent to be drained.

The mounting surface must be able to support the weight of the valve terminal and any forces that arise, and must enable torsion-free assembly.

Sub-bases directly connected to the right- and left-hand end plates and every fifth sub-base within the valve terminal must be provided with mounting holes.

### Assembly with tubing throughfeed

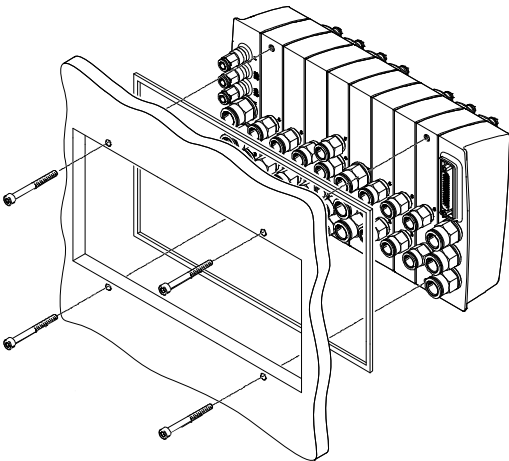

### Assembly with spacer bolts

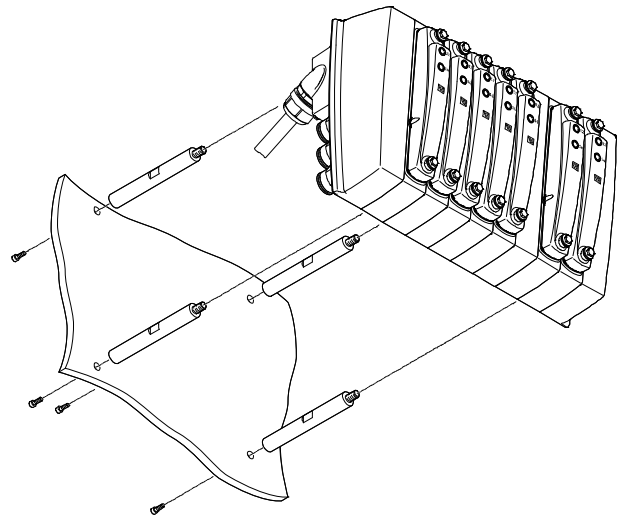

# Valve terminal MPA-C

Key features – Assembly

## Tie rod Structure

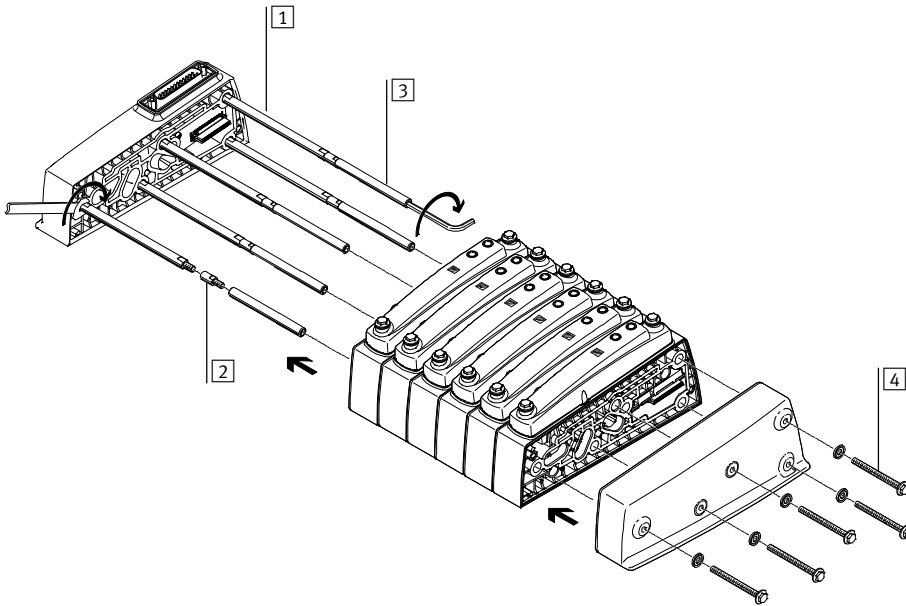

- 1 Threaded rod
- 2 Tie rod extender
- 3 Sleeve
- 4 Screw

## Mode of operation

The tie rod for the MPA-C consists of four parts:

- Threaded rod
- Tie rod extender
- Sleeve
- Screw

This enables valve terminals of any length to be created.

It takes just 4 steps to assemble the tie rod and the valve terminal:

- Screw the sleeves to the threaded rods
- Push the rod/sleeve combination into the tie rod shafts of the sub-bases and push the power supply modules onto the left-hand end plate
- Screw the rod/sleeve combination onto the left-hand end plate
- Push on the right-hand end plate and secure with screws that engage into the sleeves

The tie rod enables the valve terminal to be extended at a later date. This is done by loosening the tie rod screws and disassembling the relevant components. The additional sub-base or power supply module is inserted at the required location. The previously disassembled components are then re-assembled.

To compensate for the change in length, the tie rod must be extended by the increase in length. This is done by screwing in extenders between the threaded rod and sleeve.

 Note

To ensure the valve terminal is properly sealed, you must:

- Check the seals between the sub-bases and replace them, if necessary, before the assembly stage during conversion work
- Tighten the tie rod screws in the correct order
- Tighten the tie rod screws to the correct torque

# Valve terminal MPA-C

Key features – Assembly

## Tie rod – Components and design

### Tie rod (threaded rod)

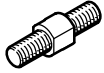

The threaded rod is used to construct a cost-optimised fixed-grid tie rod.

### Tie rod extender

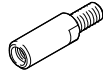

The valve terminal can be extended almost infinitely using tie rod extenders. The tie rod extenders are inserted between the threaded rod and the sleeve.

### Sleeve

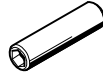

The primary purpose of the sleeve is to compensate for tolerances that occur, for example, when the seals are compressed between the sub-bases during assembly. The sleeves come in different lengths, tailored to the use of a tie rod in a fixed grid as well as generally for the individual modular tie rods.

### Screw

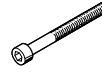

The entire valve terminal is clamped via the tie rod using the screw. Tolerances that occur, for example when the seals are compressed between the sub-bases during assembly, are compensated for by the interaction of the screw and sleeve.

## Individual modular tie rod

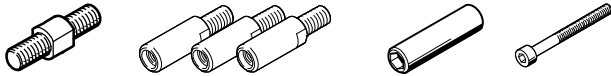

Tie rods can be constructed entirely using tie rod extenders. The threaded rod and sleeve are required to compensate for tolerances that occur, for

example when the seals are compressed between the sub-bases during assembly.

## Fixed-grid tie rod with extension

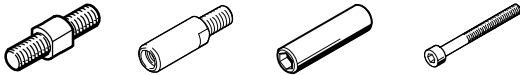

The tie rod extenders are inserted between the threaded rod and the sleeve.

They are available in suitable lengths for sub-bases and supply modules.

## Fixed-grid tie rod



The fixed-grid tie rod minimises assembly costs when assembling previously defined valve terminals. These valve terminals can be extended at any time.

The threaded rod (and, if applicable, the sleeve too) must be replaced if the valve terminal length is reduced.

## Valve terminal MPA-C

Key features – Assembly

Ordering data – Fixed-grid tie rod						
Number of sub-bases and power supply modules	Tie rod		Sleeve		Tie rod extender	
	Part No.	Type	Part No.	Type	Part No.	Type
1	8025286	VMPAC-ZAS-5	8025283	VMPAC-ZAH-46	–	–
2	8025286	VMPAC-ZAS-5	8025285	VMPAC-ZAH-66	–	–
3	8025287	VMPAC-ZAS-45	8025284	VMPAC-ZAH-56	–	–
4	8025288	VMPAC-ZAS-85	8025283	VMPAC-ZAH-46	–	–
5	8025288	VMPAC-ZAS-85	8025285	VMPAC-ZAH-66	–	–
6	8025289	VMPAC-ZAS-125	8025284	VMPAC-ZAH-56	–	–
7	8025290	VMPAC-ZAS-165	8025283	VMPAC-ZAH-46	–	–
8	8025291	VMPAC-ZAS-205	8025282	VMPAC-ZAH-36	–	–
9	8025291	VMPAC-ZAS-205	8025284	VMPAC-ZAH-56	–	–
10	8025292	VMPAC-ZAS-245	8025283	VMPAC-ZAH-46	–	–
11	8025293	VMPAC-ZAS-285	8025282	VMPAC-ZAH-36	–	–
12	8025293	VMPAC-ZAS-285	8025285	VMPAC-ZAH-66	–	–
13	8025294	VMPAC-ZAS-325	8025283	VMPAC-ZAH-46	–	–
14	8025295	VMPAC-ZAS-365	8025282	VMPAC-ZAH-36	–	–
15	8025295	VMPAC-ZAS-365	8025285	VMPAC-ZAH-66	–	–
16	8025296	VMPAC-ZAS-405	8025284	VMPAC-ZAH-56	–	–
17	8025297	VMPAC-ZAS-445	8025282	VMPAC-ZAH-36	–	–
18	8025297	VMPAC-ZAS-445	8025285	VMPAC-ZAH-66	–	–
19	8025298	VMPAC-ZAS-485	8025284	VMPAC-ZAH-56	–	–
20	8025299	VMPAC-ZAS-525	8025282	VMPAC-ZAH-36	–	–
21	8025299	VMPAC-ZAS-525	8025285	VMPAC-ZAH-66	–	–
22	8025300	VMPAC-ZAS-565	8025284	VMPAC-ZAH-56	–	–
23	8025301	VMPAC-ZAS-605	8025283	VMPAC-ZAH-46	–	–
24	8025301	VMPAC-ZAS-605	8025285	VMPAC-ZAH-66	–	–
25	8025302	VMPAC-ZAS-645	8025284	VMPAC-ZAH-56	–	–
26	8025303	VMPAC-ZAS-685	8025283	VMPAC-ZAH-46	–	–
27	8025303	VMPAC-ZAS-685	8025285	VMPAC-ZAH-66	–	–
28	8025304	VMPAC-ZAS-725	8025284	VMPAC-ZAH-56	–	–
29	8025305	VMPAC-ZAS-765	8025283	VMPAC-ZAH-46	–	–
30	8025305	VMPAC-ZAS-765	8025284	VMPAC-ZAH-56	8038824	VMPAC-ZAE-20
31	8025306	VMPAC-ZAS-805	8025284	VMPAC-ZAH-56	–	–
32	8025307	VMPAC-ZAS-845	8025283	VMPAC-ZAH-46	–	–
33	8025307	VMPAC-ZAS-845	8025284	VMPAC-ZAH-56	8038824	VMPAC-ZAE-20
34	8025308	VMPAC-ZAS-885	8025285	VMPAC-ZAH-66	–	–
35	8025309	VMPAC-ZAS-925	8025283	VMPAC-ZAH-46	–	–
36	8025309	VMPAC-ZAS-925	8025284	VMPAC-ZAH-56	8038824	VMPAC-ZAE-20
37	8025310	VMPAC-ZAS-965	8025285	VMPAC-ZAH-66	–	–
38	8025311	VMPAC-ZAS-1005	8025283	VMPAC-ZAH-46	–	–
39	8025311	VMPAC-ZAS-1005	8025284	VMPAC-ZAH-56	8038824	VMPAC-ZAE-20
40	8025312	VMPAC-ZAS-1045	8025285	VMPAC-ZAH-66	–	–



# Valve terminal MPA-C

Key features – Display and operation

## Display and operation

### Switching status indication

Each solenoid coil is allocated an LED that indicates its signal status.

- Indicator 12 shows the switching status of the coil for duct 2
- Indicator 14 shows the switching status of the coil for duct 4

### Manual override

The manual override (MO) enables the valve to be actuated when not electrically activated or energised. The valve is switched by pushing the manual override.

### Cover

The inspection window for the switching status indication and valve designation, and the manual override mechanism, are located in the cover.

Irrespective of this, the valves below are always equipped with switching status indication and manual override.

## Indicators and control elements

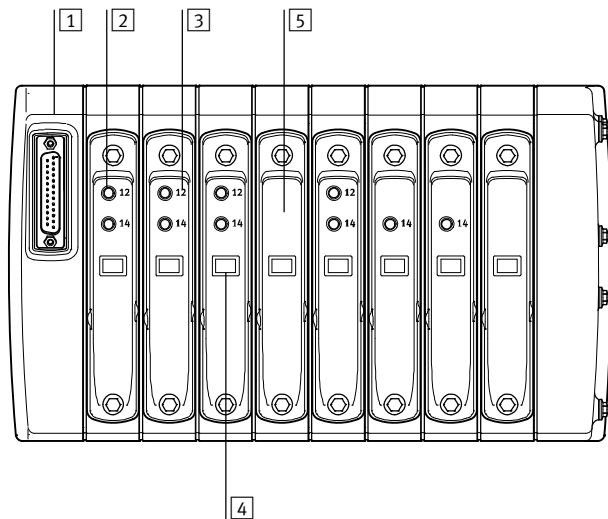

- 1 Left-hand end plate with electrical connection (multi-pin plug or I-Port interface/IO-Link)
- 2 Manual override (for each pilot solenoid coil, non-detenting)
- 3 Switching status indication (for each pilot solenoid coil)
- 4 Inspection window for valve designation
- 5 Cover without manual override and without switching status indication

 **Note**

A valve actuated manually (by means of the manual override) cannot be reset electrically. Conversely, an electrically actuated valve cannot be reset using the manual override.

## Manual override (MO)

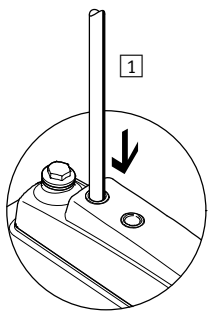

- 1 Press in the plunger of the MO using a blunt plastic pin. The pilot valve switches and actuates the main valve.

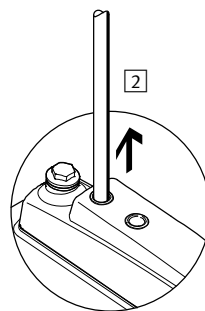

- 2 Remove the pin. Spring force pushes the plunger of the MO back. The pilot valve returns to its initial position and so too the single solenoid main valve (this is not the case with a double solenoid valve).

# Valve terminal MPA-C

Key features – Electrical components

## Electrical power as a result of current reduction

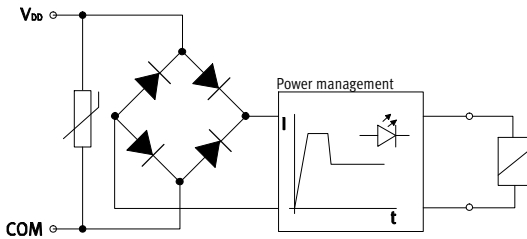

Each solenoid coil is protected with a spark arresting protective circuit as well as against polarity reversal. All valve types are additionally equipped with integrated current reduction.

MPA-C valves are supplied with operating voltage in the range 21.6 ... 26.4 V (24 V +/-10%).

## Electrical connection – Left-hand end plate

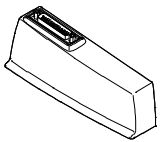

The electrical connection from the valves to the higher-order controller is in the left-hand end plate. Switching between the various

connection options is easy: simply swap the left-hand end plate; the pneumatic interlinking remains as is. The valves are switched by means of

positive or negative logic (PNP or NPN). Mixed operation is not permitted.

## Guidelines on addressing for valves/solenoid coils

The numbering of the addresses goes from left to right in ascending consecutive order. The following applies at the individual valve positions: address x for coil 14 and address x+1 for coil 12.

Each sub-base occupies a defined number of addresses/pins:

- For 1 solenoid coil: 1
- For 2 solenoid coils: 2



**Note**

If a single solenoid valve is assembled on a double solenoid valve position, the second address (for coil 12) is also occupied and cannot be used.

## Variants of the left-hand end plate

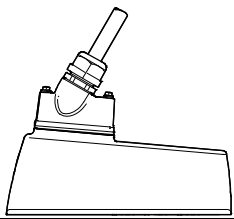
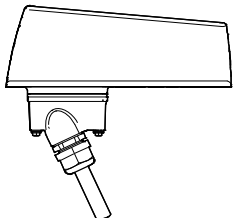
Graphical illustration	Code	Type	Maximum number of addresses	Notes
<b>Outlet, electrical connection at top</b>				
	Electrical connection: MS1	VMPAC-EPL-MP-SD25-0	24	Electrical connection Sub-D, 25-pin
	Electrical connection: MS3	VMPAC-EPL-MP-SD44-0	32	Electrical connection Sub-D, 44-pin
	Electrical connection: PT	VMPAC-EPL-IP-0	32	Electrical connection Sub-D, 9-pin I-Port interface/IO-Link
<b>Outlet, electrical connection at bottom</b>				
	Electrical connection: MS1	VMPAC-EPL-MP-SD25	24	Electrical connection Sub-D, 25-pin
	Electrical connection: MS3	VMPAC-EPL-MP-SD44	32	Electrical connection Sub-D, 44-pin
	Electrical connection: PT	VMPAC-EPL-IP	32	Electrical connection Sub-D, 9-pin I-Port interface/IO-Link

# Valve terminal MPA-C

Key features – Electrical components

## Pin allocation for electrical multi-pin plug connection – Sub-D plug, 25-pin, connecting cable NEBV-C-S1WA25...

	Pin	Address/ coil	Wire colour <sup>2)</sup> of connecting cable		Pin	Address/ coil	Wire colour <sup>2)</sup> of connecting cable	
	1	0	WH		14	13	BN GN	- Note The drawing shows the view onto the pins of the Sub-D plug.
	2	1	BN		15	14	YE WH	
	3	2	GN		16	15	BN YE	
	4	3	YE		17	16	GY WH	
	5	4	GY		18	17	BN GY	
	6	5	PK		19	18	WH PK	
	7	6	BU		20	19	BN PK	
	8	7	RD		21	20	BU WH	
	9	8	BK		22	21	BN BU	
	10	9	VT		23	22	RD WH	
	11	10	GY PK		24	23	BN RD	
	12	11	RD BU		25	0 V <sup>1)</sup>	BK WH	
	13	12	GN WH					

- 1) 0 V for positive switching control signals; connect 24 V for negative switching control signals; mixed operation is not permitted.  
2) To IEC 757

## Pin allocation for electrical multi-pin plug connection – Sub-D plug, 44-pin, connecting cable NEBV-C-S1WA44...

	Pin	Address/ coil	Wire colour <sup>2)</sup> of connecting cable		Pin	Address/ coil	Wire colour <sup>2)</sup> of connecting cable		Pin	Address/ coil	Wire colour <sup>2)</sup> of connecting cable
	1	0	WH		18	17	BN GY	- Note The drawing shows the view onto the pins of the Sub-D plug.	35	n.c.	n.c.
	2	1	BN		19	18	WH PK		36	n.c.	n.c.
	3	2	GN		20	19	BN PK		37	n.c.	n.c.
	4	3	YE		21	20	BU WH		38	n.c.	n.c.
	5	4	GY		22	21	BN BU		39	n.c.	n.c.
	6	5	PK		23	22	RD WH		40	n.c.	n.c.
	7	6	BU		24	23	BN RD		41	n.c.	RD GN
	8	7	RD		25	24	BK WH		42	n.c.	RD YE
	9	8	BK		26	25	BK BN		43	0 V <sup>1)</sup>	BK GN
	10	9	VT		27	26	GN GY		44	0 V <sup>1)</sup>	BK YE
	11	10	GY PK		28	27	YE GY				
	12	11	RD BU		29	28	GN PK				
	13	12	GN WH		30	29	YE PK				
	14	13	BN GN		31	30	GN BU				
	15	14	YE WH		32	31	YE BU				
	16	15	BN YE		33	n.c.	n.c.				
	17	16	GY WH		34	n.c.	n.c.				

- 1) 0 V for positive switching control signals; connect 24 V for negative switching control signals; mixed operation is not permitted.  
2) To IEC 757

## Valve terminal MPA-C

Key features – Electrical components

### I-Port interface/IO-Link

The I-Port interface/IO-Link enables the MPA-C valve terminal to be connected to the following systems:

- I-Port master from Festo (CPX terminal, CECC)
- Fieldbus node CTEU from Festo

- IO-Link master  
The maximum distance between the I-Port/IO-Link master and valve terminal with I-Port interface/IO-Link is 20 m.



The 5-pin connecting cables contain the power supply for the valves; separate from this is the power supply for the internal valve terminal electronics and the control signals.



Note

More information can be found at:  
➔ Internet: cteu

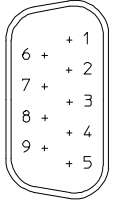
### Pin allocation for I-Port interface/IO-Link – Sub-D plug, 9-pin, connecting cable NEBC-C-S1WA9...

	Pin	Designation	Wire colour <sup>1)</sup> of connecting cable	
	1	Communication signal C/Q, data transmission line	BK	 <p>Note</p> <p>The drawing shows the view onto the Sub-D plug on the I-Port interface/IO-Link.</p>
	2	0 V DC load voltage supply for valves and outputs	GY	
	3	0 V DC supply voltage for electronics and sensors	Caption	
	4	24 V DC load voltage supply for valves and outputs	WH	
	5	24 V DC supply voltage for electronics and inputs	BN	
	6	n.c.	n.c.	
	7	n.c.	n.c.	
	8	n.c.	n.c.	
	9	n.c.	n.c.	

1) To IEC 757

## Valve terminal MPA-C

Key features – Electrical components

### Instructions for use

#### Equipment

Operate system equipment with unlubricated compressed air if possible. Festo valves and cylinders are designed so that, if used as intended, they will not require additional lubrication and will still achieve a long service life. The quality of compressed air downstream of the compressor must correspond to that of unlubricated compressed air. If possible, do not operate all of your system equipment with lubricated compressed air. The lubricators should, where possible, always be installed directly upstream of the actuator used.

Incorrect additional oil and too high an oil content in the compressed air reduce the service life of the valve terminal.

Use Festo special oil OFSW-32 or the alternatives listed in the Festo catalogue (as specified in DIN 51524 HLP32; basic oil viscosity 32 CST at 40 °C).

#### Bio-oils



When using bio-oils (oils which are based on synthetic or native ester, e.g. rapeseed oil methyl ester), the maximum residual oil content of 0.1 mg/m<sup>3</sup> must not be exceeded (see ISO 8573-1 Class 2).

#### Mineral oils

When using mineral oils (e.g. HLP oils to DIN 51524, parts 1 to 3) or similar oils based on poly-alpha-olefins (PAO), the maximum residual oil content of 5 mg/m<sup>3</sup> must not be exceeded (see ISO 8573-1 Class 4). A higher residual oil content irrespective of the compressor oil cannot be permitted, as the basic lubricant would be flushed out over time.

## Valve terminal MPA-C

Technical data

-  - Flow rate  
Up to 780 l/min
  
-  - Valve width  
14 mm
  
-  - Voltage  
24 V DC



General technical data	
Valve terminal design	Modular and expandable
Electric activation	Multi-pin plug
	I-Port interface/IO-Link
Type of actuation	Electrical
Type of pilot control	Electrical
Nominal operating voltage [V DC]	24
Permissible voltage fluctuations [%]	±25
Maximum number of valve positions	32
Maximum number of pressure zones	30
Valve size [mm]	14
Switching status indication	LED
Pilot air supply	Internal or external
Degree of protection	IP65, IP67, IP69K

Operating and environmental conditions	
Operating medium	Compressed air to ISO 8573-1:2010 [7:4:4] → 21
Note on operating/pilot medium	Lubricated operation possible (in which case lubricated operation will always be required)
Operating pressure [bar]	-0.9 ... +8
Pilot pressure [bar]	3 ... 8
Ambient temperature [°C]	-5 ... +60
Temperature of medium [°C]	-5 ... +50
Storage temperature [°C]	-20 ... +40
Corrosion resistance class CRC <sup>1)</sup>	4
Suitable for use in the food industry	As per manufacturer's declaration <sup>2)</sup>

- 1) Corrosion resistance class CRC 4 to Festo standard FN 940070  
Particularly high corrosion stress. Outdoor exposure under extreme corrosive conditions. Parts exposed to aggressive media, for instance in the chemical or food industries. These applications may need to be supported by special tests (→ also FN 940082) using appropriate media.
- 2) Additional information [www.festo.com/sp](http://www.festo.com/sp) → User documentation.

Safety characteristics	
CE marking (see declaration of conformity)	To EU EMC Directive <sup>1)</sup>
Shock resistance	Shock test with severity level 2 to FN 942017-5 and EN 60068-2-27
Vibration resistance	Transport application test with severity level 2 to FN 942017-4 and EN 60068-2-6

- 1) For information about the applicability of the component see the manufacturer's EC declaration of conformity at: [www.festo.com/sp](http://www.festo.com/sp) → User documentation.  
If the component is subject to restrictions on usage in residential, office or commercial environments or small businesses, further measures to reduce the emitted interference may be necessary.

# Valve terminal MPA-C

Technical data

Technical data – Valves		M	J	N	K	H	B	G	E	X	W	D	I	MS	NS	KS	HS	DS	
Code for position function 1-32																			
Design		Piston spool valve																	
Sealing principle		Soft																	
Non-overlapping		Yes																	
Manual override		Non-detenting, detenting																	
Type of reset		Pneumatic spring					Mechanical spring			Pneumatic spring				Mechanical spring					
Switching times	On [ms]	13	9	12	12	12	16	13	13	12	12	12	10	13	12	12	12	10	
	Off [ms]	30	–	38	38	38	50	52	50	20	20	30	28	30	23	23	23	25	
	Change-over [ms]	–	24	–	–	–	26	26	26	–	–	–	–	–	–	–	–	–	
Standard nominal flow rate [l/min]		720	770	730	760	730	690	660	550	510	450	720	730	730	550	600	550	570	
Operating pressure [bar]		–0.9 ... +10			3 ... 10			–0.9 ... +10			–0.9 ... +10			3 ... 10			–0.9 ... +8		
Pilot pressure [bar]		3 ... 8																	
Maximum assembly torque for valve mounting [Nm]		0.65																	

Safety characteristics – Valves	
Note on forced checking procedure	Min. 1/week
CE marking (see declaration of conformity)	To EU EMC Directive <sup>1)</sup>
Maximum positive test pulse with 0 signal [μs]	400
Maximum negative test pulse with 1 signal [μs]	200
Shock resistance	Shock test with severity level 2 to FN 942017-5 and EN 60068-2-27
Vibration resistance	Transport application test with severity level 2 to FN 942017-4 and EN 60068-2-6

1) For information about the applicability of the component see the manufacturer's EC declaration of conformity at: [www.festo.com/sp](http://www.festo.com/sp) → User documentation.  
If the component is subject to restrictions on usage in residential, office or commercial environments or small businesses, further measures to reduce the emitted interference may be necessary.

## Valve terminal MPA-C

Technical data

Pneumatic connections		
Right-hand end plate		
Supply	1	Thread G3/8
Exhaust port	3	Thread G3/8
	5	Thread G3/8
	L	Thread G1/8
Pilot air supply	12/14	Thread G1/8
Pilot exhaust air	82/84	Thread G1/8
Left-hand end plate		
Supply	1	Thread G3/8
Exhaust port	3	Thread G3/8
	5	Thread G3/8
Power supply module		
Supply	1	Thread G3/8
Exhaust port	3	Thread G3/8
	5	Thread G3/8
Sub-base		
Working ports	2	Thread G1/4
	4	Thread G1/4
Sub-base with additional power supply		
Supply	1	Thread G1/4
Exhaust port	3	Thread G1/4
	5	Thread G1/4
Working ports	2	Thread G1/4
	4	Thread G1/4



# Valve terminal MPA-C

Technical data

## Pilot pressure p2 as a function of working pressure p1 with external pilot air supply

For valves with code for position function 1-32: M, J, B, G, E, W, X

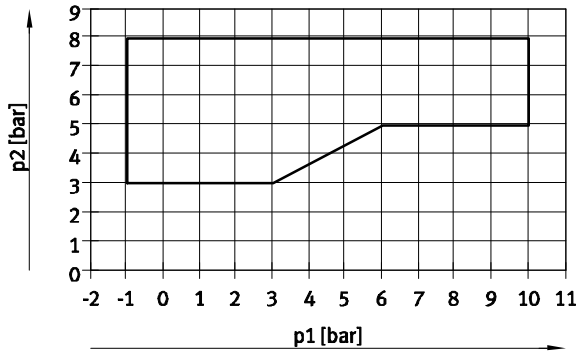

For valves with code for position function 1-32: N, K, H, D, I

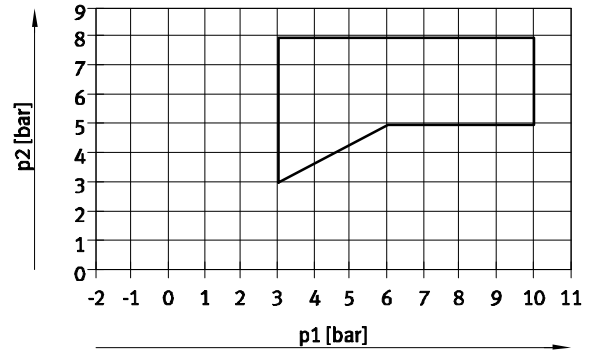

For valves with code for position function 1-32: MS, NS, KS, HS, DS

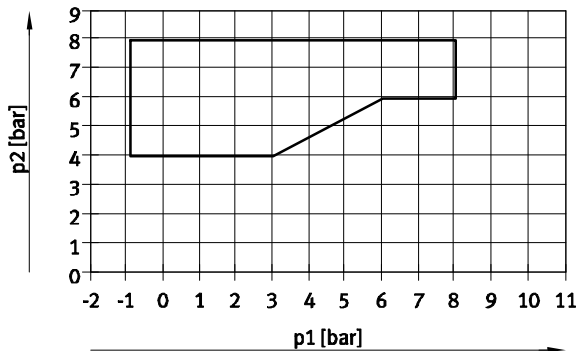

## Current consumption per solenoid coil at nominal voltage

Nominal pick-up current	[mA]	50
Nominal current with current reduction	[mA]	10
Time until current reduction	[ms]	20

## Materials

Sub-base	Reinforced PA
Power supply module	Reinforced PA
End plate	Reinforced PA
Valve	Die-cast aluminium
Cover	Reinforced PA
Seals	EPDM, NBR
Separator for pressure zone separation	Reinforced PA, NBR
Tie rod	Stainless steel
Spacer bolt	Stainless steel
Note on materials	RoHS-compliant

## Valve terminal MPA-C

Technical data

Product weight	
	Approx. weight [g]
Sub-base	160
Power supply module	156
Left-hand end plate	246
Right-hand end plate	224
Valve	77
Cover	42
Vacant position	23
Separator for pressure zone separation	15
Screw for tie rod	3
Sleeve for tie rod, 36/46/56/66 mm	6/8/9/11
Spacer bolt	80

Product weight – Threaded rods, tie rods																
Length [mm]	5	45	85	125	165	205	245	285	325	365	405	445	485	525	565	605
Threaded rods, tie rods [g]	2	11	20	29	38	47	54	65	72	80	89	98	109	118	127	136
Length [mm]	645	685	725	765	786	805	845	866	885	925	946	965	1005	1026	1045	
Threaded rods, tie rods [g]	145	154	163	170	174	181	188	192	198	205	209	214	225	229	234	

# Valve terminal MPA-C

Technical data

## Dimensions

Download CAD data → [www.festo.com](http://www.festo.com)

Valve terminal

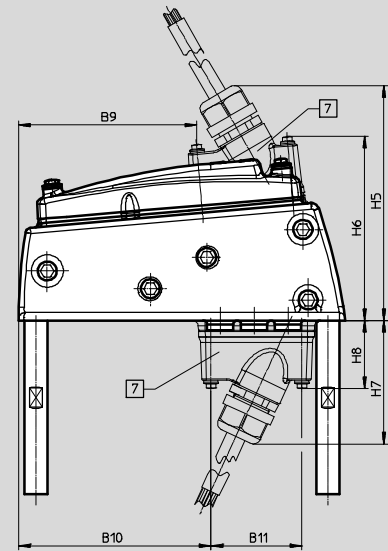
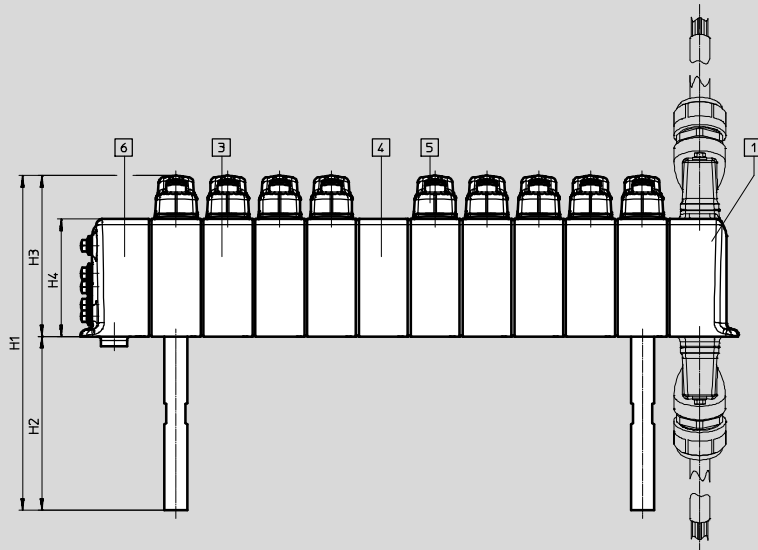
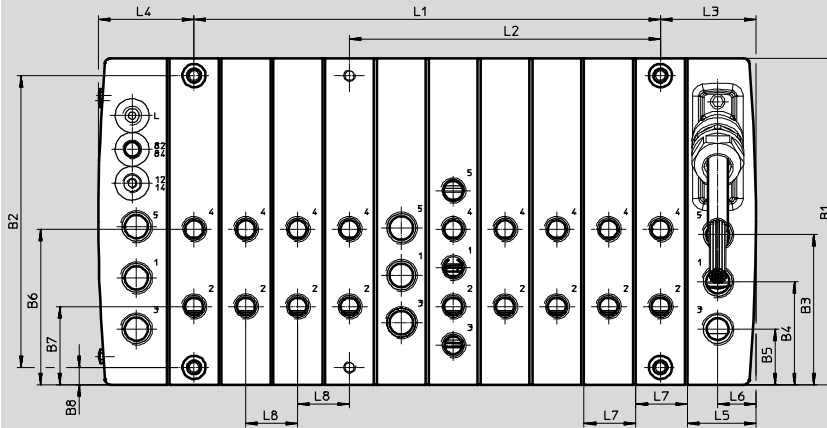

- 1 Left-hand end plate, electrical connection
- 3 Sub-base
- 5 Cover
- 4 Power supply module
- 6 Right-hand end plate
- 7 Electrical connection

Type	B1	B2	B3	B4	B5	B6	B7	B8	B9	B10	B11	H1	H2	H3	H4	H5
MPA-C	169	151	77.8	53.3	28.8	80.5	40.5	9	92	99.5	47	172.7	90	82.7	60.7	121.5

Type	H6	H7	H8	L1	L2	L3	L4	L5	L6	L7	L8
MPA-C	95.2	64.9	36.4	(n-1) x 26.8	(n-1) x 26.8	49.6	49.5	35.4	19.7	26.8	26.8

1) n = Total number of sub-bases/valve positions and power supply modules

# Valve terminal MPA-C

Technical data

**Dimensions – Pneumatic connections**

Download CAD data → [www.festo.com](http://www.festo.com)

Right-hand end plate, sub-base with mounting holes

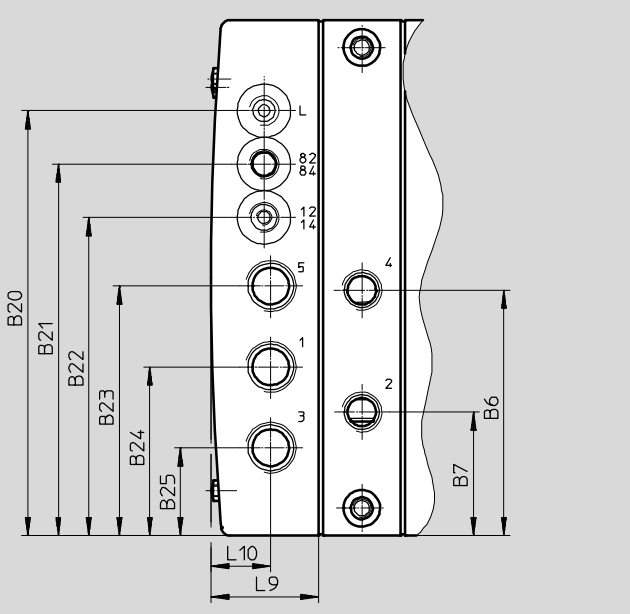

Power supply module, sub-base with additional power supply

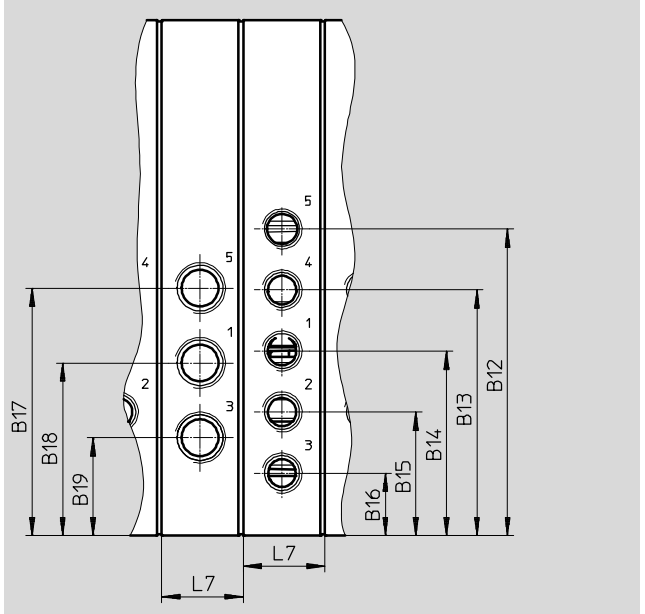

	B12	B13	B14	B15	B16	B17	B18	B19	L7
Power supply module, sub-base with additional power supply	100.5	80.5	60.5	40.5	20.5	81.1	56.6	32.1	26.8

	B6	B7	B20	B21	B22	B23	B24	B25	L9	L10
Right-hand end plate	80.5	40.5	139.3	121.8	104.3	81.8	55.3	28.8	35.4	19.6

# Valve terminal MPA-C

Accessories

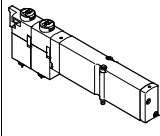
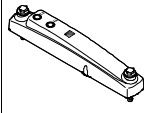
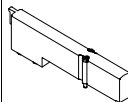
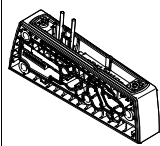
Ordering data					
	Code	Valve function	Part No.	Type	
<b>Individual solenoid valves</b>					
	5/2-way valve				
	Position function 1-32: M	Single solenoid	578806	VMPA14-M1HF-M-PI	
	Position function 1-32: MS	Single solenoid Mechanical spring return	578817	VMPA14-M1HF-MS-PI	
	Position function 1-32: J	Double solenoid	578805	VMPA14-M1HF-J-PI	
	2x 3/2-way valve				
	Position function 1-32: N	Normally open	578813	VMPA14-M1HF-N-PI	
	Position function 1-32: NS	Normally open, mechanical spring return	578819	VMPA14-M1HF-NS-PI	
	Position function 1-32: K	Normally closed	578812	VMPA14-M1HF-K-PI	
	Position function 1-32: KS	Normally closed, mechanical spring return	578818	VMPA14-M1HF-KS-PI	
	Position function 1-32: H	1x normally open, 1x normally closed	578814	VMPA14-M1HF-H-PI	
	Position function 1-32: HS	1x normally open, 1x normally closed, mechanical spring return	578821	VMPA14-M1HF-HS-PI	
	5/3-way valve				
	Position function 1-32: B	Mid-position pressurised	578807	VMPA14-M1HF-B-PI	
	Position function 1-32: G	Mid-position closed	578809	VMPA14-M1HF-G-PI	
	Position function 1-32: E	Mid-position exhausted	578808	VMPA14-M1HF-E-PI	
	3/2-way valve				
	Position function 1-32: W	Normally open, external compressed air supply	578811	VMPA14-M1HF-W-PI	
	Position function 1-32: X	Normally closed, external compressed air supply	578810	VMPA14-M1HF-X-PI	
	2x 2/2-way valve				
Position function 1-32: D	Normally closed	578815	VMPA14-M1HF-D-PI		
Position function 1-32: DS	Normally closed, mechanical spring return	578820	VMPA14-M1HF-DS-PI		
Position function 1-32: I	1x normally closed, 1x normally closed, reversible only	578816	VMPA14-M1HF-I-PI		
<b>Cover</b>					
	-	Cover over a valve position	Without manual override	576588	VMPAC-VC-14
			With manual override for one pilot control	576586	VMPAC-VC-MO-14-1
			With manual override for two pilot controls	576587	VMPAC-VC-MO-14-2
<b>Blanking plate</b>					
	Position function 1-32: L	Blanking plate for a valve position instead of a valve; a self-adhesive label is supplied.		573729	VMPA14-RP
<b>Connecting plate</b>					
	Type of module block 1 - 40: F	For 1 solenoid coil	-	576572	VMPAC-AP-14-1
			With mounting holes	576574	VMPAC-AP-14-B-1
			With additional power supply	576576	VMPAC-AP-14-SP-1
	Type of module block 1 - 40: E	For 2 solenoid coils	-	576573	VMPAC-AP-14-2
			With mounting holes	576575	VMPAC-AP-14-B-2
			With additional power supply	576577	VMPAC-AP-14-SP-2

# Valve terminal MPA-C

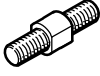
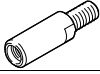
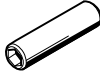
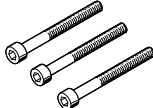

Accessories

Ordering data						
	Code	Description	Part No.	Type	PU <sup>1)</sup>	
<b>Tie rod</b>						
	-	Threaded rod for tie rod, width across flats 5 mm The threaded rod/sleeve combination is selected based on the number and width of the individual sub-bases.	5 mm	<b>8025286</b>	<b>VMPAC-ZAS-5</b>	5
			45 mm	<b>8025287</b>	<b>VMPAC-ZAS-45</b>	5
			85 mm	<b>8025288</b>	<b>VMPAC-ZAS-85</b>	5
			125 mm	<b>8025289</b>	<b>VMPAC-ZAS-125</b>	5
			165 mm	<b>8025290</b>	<b>VMPAC-ZAS-165</b>	5
			205 mm	<b>8025291</b>	<b>VMPAC-ZAS-205</b>	5
			245 mm	<b>8025292</b>	<b>VMPAC-ZAS-245</b>	5
			285 mm	<b>8025293</b>	<b>VMPAC-ZAS-285</b>	5
			325 mm	<b>8025294</b>	<b>VMPAC-ZAS-325</b>	5
			365 mm	<b>8025295</b>	<b>VMPAC-ZAS-365</b>	5
			405 mm	<b>8025296</b>	<b>VMPAC-ZAS-405</b>	5
			445 mm	<b>8025297</b>	<b>VMPAC-ZAS-445</b>	5
			485 mm	<b>8025298</b>	<b>VMPAC-ZAS-485</b>	5
			525 mm	<b>8025299</b>	<b>VMPAC-ZAS-525</b>	5
			565 mm	<b>8025300</b>	<b>VMPAC-ZAS-565</b>	5
			605 mm	<b>8025301</b>	<b>VMPAC-ZAS-605</b>	5
			645 mm	<b>8025302</b>	<b>VMPAC-ZAS-645</b>	5
			685 mm	<b>8025303</b>	<b>VMPAC-ZAS-685</b>	5
			725 mm	<b>8025304</b>	<b>VMPAC-ZAS-725</b>	5
			765 mm	<b>8025305</b>	<b>VMPAC-ZAS-765</b>	5
			786 mm	<b>8032685</b>	<b>VMPAC-ZAS-786</b>	5
	805 mm	<b>8025306</b>	<b>VMPAC-ZAS-805</b>	5		
	845 mm	<b>8025307</b>	<b>VMPAC-ZAS-845</b>	5		
	866 mm	<b>8032686</b>	<b>VMPAC-ZAS-866</b>	5		
	885 mm	<b>8025308</b>	<b>VMPAC-ZAS-885</b>	5		
	925 mm	<b>8025309</b>	<b>VMPAC-ZAS-925</b>	5		
	946 mm	<b>8032687</b>	<b>VMPAC-ZAS-946</b>	5		
	965 mm	<b>8025310</b>	<b>VMPAC-ZAS-965</b>	5		
	1005 mm	<b>8025311</b>	<b>VMPAC-ZAS-1005</b>	5		
	1026 mm	<b>8032688</b>	<b>VMPAC-ZAS-1026</b>	5		
	1045 mm	<b>8025312</b>	<b>VMPAC-ZAS-1045</b>	5		
	-	Tie rod extender, width across flats 5 mm	15 mm	<b>8025281</b>	<b>VMPAC-ZAE-14</b>	5
			21 mm	<b>8038824</b>	<b>VMPAC-ZAE-20</b>	3
	-	Sleeve, internal hex 4 mm	36 mm	<b>8025282</b>	<b>VMPAC-ZAH-36</b>	5
			46 mm	<b>8025283</b>	<b>VMPAC-ZAH-46</b>	5
			56 mm	<b>8025284</b>	<b>VMPAC-ZAH-56</b>	5
			66 mm	<b>8025285</b>	<b>VMPAC-ZAH-66</b>	5
	-	Screw M4x38 mm with external hexagon 6 mm, for tie rod	5 pieces	<b>8025280</b>	<b>VMPAC-M4X38</b>	5

1) Packaging unit quantity.

# Valve terminal MPA-C

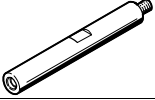
Accessories

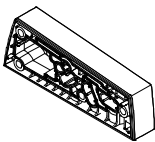
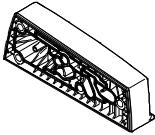
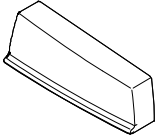
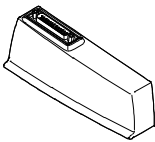
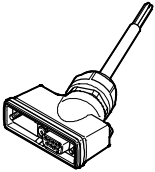
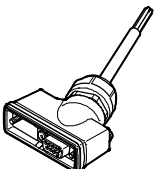
Ordering data						
	Code	Description	Part No.	Type		
<b>Mounting</b>						
	Type of mounting: Y	Spacer bolts for mounting the valve terminal	4 pieces	<b>576585</b>	<b>VMPAC-BA</b>	
<b>Separator</b>						
	–	For pressure zone separation	3 pieces	<b>576578</b>	<b>VMPAC-TE-1-3-5</b>	
<b>Power supply module</b>						
	Type of module block 1-40: U	With electrical interlinking module		<b>576569</b>	<b>VMPAC-SP-0</b>	
<b>Right-hand end plate</b>						
	Pilot air: Z	With internal pilot air supply		<b>576563</b>	<b>VMPAC-EPR-IN</b>	
	Pilot air: –	With external pilot air supply		<b>576564</b>	<b>VMPAC-EPR-EX</b>	
<b>Left-hand end plate</b>						
	Electrical connection: MS1	Electrical connection at bottom		Sub-D, 25-pin, 24 addresses	<b>576557</b> <b>VMPAC-EPL-MP-SD25</b>	
	Electrical connection: MS3			Sub-D, 44-pin, 32 addresses	<b>576559</b> <b>VMPAC-EPL-MP-SD44</b>	
	Electrical connection: PT			Node with I-Port interface 32 addresses	<b>576561</b> <b>VMPAC-EPL-IP</b>	
	Electrical connection: MS1	Electrical connection at top		Sub-D, 25-pin, 24 addresses	<b>576558</b> <b>VMPAC-EPL-MP-SD25-0</b>	
	Electrical connection: MS3			Sub-D, 44-pin, 32 addresses	<b>576560</b> <b>VMPAC-EPL-MP-SD44-0</b>	
	Electrical connection: PT			Node with I-Port interface 32 addresses	<b>576562</b> <b>VMPAC-EPL-IP-0</b>	
<b>Connecting cable for I-Port interface/IO-Link</b>						
	Connecting cable: FH	9-pin socket, Sub-D, open cable end 5-wire		2.5 m	<b>2376018</b> <b>NEBC-C-S1WA9-F-2.5-N-B-LE5-PT-S10</b>	
	Connecting cable: FI			5 m	<b>2376019</b> <b>NEBC-C-S1WA9-F-5-N-B-LE5-PT-S10</b>	
	Connecting cable: FJ			10 m	<b>2376020</b> <b>NEBC-C-S1WA9-F-10-N-B-LE5-PT-S10</b>	
<b>Connecting cable for multi-pin plug connection</b>						
	Connecting cable: FA	25-pin socket, Sub-D, open cable end		2.5 m	<b>2265131</b> <b>NEBV-C-S1WA25-F-2.5-N-LE25-S10</b>	
	Connecting cable: FB			25-wire	5 m	<b>2265132</b> <b>NEBV-C-S1WA25-F-5-N-LE25-S10</b>
	Connecting cable: FC				10 m	<b>2265133</b> <b>NEBV-C-S1WA25-F-10-N-LE25-S10</b>
	Connecting cable: FD	44-pin socket, Sub-D, open cable end		2.5 m	<b>577376</b> <b>NEBV-C-S1WA44-F-2.5-N-LE36-S10</b>	
	Connecting cable: FE			36-wire	5 m	<b>577377</b> <b>NEBV-C-S1WA44-F-5-N-LE36-S10</b>
	Connecting cable: FG				10 m	<b>577378</b> <b>NEBV-C-S1WA44-F-10-N-LE36-S10</b>

# Valve terminal MPA-C

Accessories

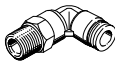
Ordering data									
	Code	Information on housing materials	Connecting thread	For tubing O.D. [mm]	Part No.	Type	PU <sup>1)</sup>		
<b>Push-in fitting, straight</b>									
	Type of push-in fitting: NPQH	Nickel-plated brass	G1/8	4	578338	NPQH-D-G18-Q4-P10	10		
				6	578339	NPQH-D-G18-Q6-P10	10		
				8	578340	NPQH-D-G18-Q8-P10	10		
			G1/4	6	578341	NPQH-D-G14-Q6-P10	10		
				8	578342	NPQH-D-G14-Q8-P10	10		
				10	578343	NPQH-D-G14-Q10-P10	10		
				12	578344	NPQH-D-G14-Q12-P10	10		
			G3/8	8	578345	NPQH-D-G38-Q8-P10	10		
				10	578346	NPQH-D-G38-Q10-P10	10		
				12	578347	NPQH-D-G38-Q12-P10	10		
				14	578348	NPQH-D-G38-Q14-P10	10		
			Type of push-in fitting: NPCK	High-alloy stainless steel	G1/8	6	1366257	NPCK-C-D-G18-K6	1
						8	1490383	NPCK-C-D-G18-K8	1
					G1/4	8	1691701	NPCK-C-D-G14-K8	1
						10	1489336	NPCK-C-D-G14-K10	1
	G3/8	10			1489614	NPCK-C-D-G38-K10	1		
	Type of push-in fitting: QS	PBT	G1/8	4	186095	QS-G1/8-4	10		
				6	186096	QS-G1/8-6	10		
				8	186098	QS-G1/8-8	10		
			G1/4	6	186097	QS-G1/4-6	10		
				8	186099	QS-G1/4-8	10		
				10	186101	QS-G1/4-10	10		
				12	186350	QS-G1/4-12	10		
			G3/8	8	186100	QS-G3/8-8	10		
				10	186102	QS-G3/8-10	10		
				12	186103	QS-G3/8-12	10		
16				186347	QS-G3/8-16	1			
<b>Push-in L-fitting</b>									
	Type of push-in fitting: NPQH	Nickel-plated brass	G1/8	4	578280	NPQH-L-G18-Q4-P10	10		
				6	578281	NPQH-L-G18-Q6-P10	10		
				8	578282	NPQH-L-G18-Q8-P10	10		
			G1/4	6	578283	NPQH-L-G14-Q6-P10	10		
				8	578284	NPQH-L-G14-Q8-P10	10		
				10	578285	NPQH-L-G14-Q10-P10	10		
				12	578286	NPQH-L-G14-Q12-P10	10		
			G3/8	8	578287	NPQH-L-G38-Q8-P10	10		
				10	578288	NPQH-L-G38-Q10-P10	10		
				12	578289	NPQH-L-G38-Q12-P10	10		
				14	578290	NPQH-L-G38-Q14-P10	10		
			Type of push-in fitting: QSL	PBT	G1/8	4	186116	QSL-G1/8-4	10
						6	186117	QSL-G1/8-6	10
						8	186119	QSL-G1/8-8	10
	G1/4	6			186118	QSL-G1/4-6	10		
		8			186120	QSL-G1/4-8	10		
		10			186122	QSL-G1/4-10	10		
		12			186351	QSL-G1/4-12	10		
	G3/8	8			186121	QSL-G3/8-8	10		
		10			186123	QSL-G3/8-10	10		
12	186124	QSL-G3/8-12	10						

1) Packaging unit quantity.



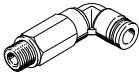

# Valve terminal MPA-C

Accessories

Ordering data										
	Code	Information on housing materials	Connecting thread	For tubing O.D. [mm]	Part No.	Type	PU <sup>1)</sup>			
<b>Push-in L-fitting, long</b>										
	Type of push-in fitting: NPQH	Nickel-plated brass	G1/8	4	<b>578263</b>	<b>NPQH-LL-G18-Q4-P10</b>	<b>10</b>			
				6	<b>578264</b>	<b>NPQH-LL-G18-Q6-P10</b>	<b>10</b>			
				8	<b>578265</b>	<b>NPQH-LL-G18-Q8-P10</b>	<b>10</b>			
			G1/4		6	<b>578266</b>	<b>NPQH-LL-G14-Q6-P10</b>	<b>10</b>		
					8	<b>578267</b>	<b>NPQH-LL-G14-Q8-P10</b>	<b>10</b>		
					10	<b>578268</b>	<b>NPQH-LL-G14-Q10-P10</b>	<b>10</b>		
			G3/8		10	<b>578269</b>	<b>NPQH-LL-G38-Q10-P10</b>	<b>10</b>		
					G1/8	PBT	4	<b>186127</b>	<b>QSLL-G1/8-4</b>	<b>10</b>
							6	<b>186128</b>	<b>QSLL-G1/8-6</b>	<b>10</b>
	8	<b>186130</b>	<b>QSLL-G1/8-8</b>	<b>10</b>						
	G1/4		6	<b>186129</b>	<b>QSLL-G1/4-6</b>	<b>10</b>				
			8	<b>186131</b>	<b>QSLL-G1/4-8</b>	<b>10</b>				
			10	<b>186133</b>	<b>QSLL-G1/4-10</b>	<b>10</b>				
	G3/8		12	<b>132596</b>	<b>QSLL-G1/4-12</b>	<b>10</b>				
			G3/8		8	<b>186132</b>	<b>QSLL-G3/8-8</b>	<b>10</b>		
					10	<b>186134</b>	<b>QSLL-G3/8-10</b>	<b>10</b>		
	12	<b>186135</b>			<b>QSLL-G3/8-12</b>	<b>10</b>				

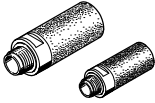
1) Packaging unit quantity.

Ordering data						
	Code	Description		Part No.	Type	PU <sup>1)</sup>
<b>Pneumatic silencer</b>						
	-	Connecting thread	G1/8	<b>161419</b>	<b>UC-1/8</b>	<b>1</b>
			G1/4	<b>165004</b>	<b>UC-1/4</b>	<b>1</b>
			G3/8	<b>1707427</b>	<b>UC-3/8</b>	<b>1</b>
				<b>576759</b>	<b>UC-3/8-20</b>	<b>20</b>
<b>Blanking plug</b>						
	-	Thread, external hexagon	G1/8	<b>196720</b>	<b>CDV15.0-B-G1/8</b>	<b>1</b>
			G1/4	<b>8035644</b>	<b>CDV15.0-B-G1/4</b>	<b>1</b>
			G3/8	<b>196712</b>	<b>CDV15.0-B-G3/8</b>	<b>1</b>
<b>User documentation</b>						
	Documentation: DE	MPA-C pneumatics	German	<b>8023739</b>	<b>GDCV-MPAC-DE</b>	
	Documentation: EN		English	<b>8023740</b>	<b>GDCV-MPAC-EN</b>	
	Documentation: FR		French	<b>8023742</b>	<b>GDCV-MPAC-FR</b>	
	Documentation: ES		Spanish	<b>8023741</b>	<b>GDCV-MPAC-ES</b>	
	Documentation: IT		Italian	<b>8023744</b>	<b>GDCV-MPAC-IT</b>	
	Documentation: ZH		Chinese	<b>8023745</b>	<b>GDCV-MPAC-ZH</b>	

1) Packaging unit quantity.