





Branching modules FRM/Distributor blocks FRZ, D series



Branching modules FRM/Distributor blocks FRZ, D series, metal design

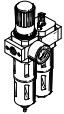
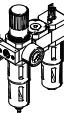
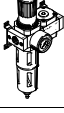
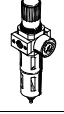
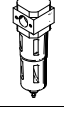
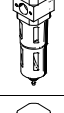

Product range overview D series service units, metal design

Type	Size	Pneumatic connection										Pressure regulation range [bar]			Grade of filtration [µm]			
		M5	M7	G1/8	G1/4	G3/8	G1/2	G3/4	G1	QS4	QS6	0.5 ...	0.5 ...	2.5 ...	0.01	1	5	40
Service units																		
FRC/FRCS 	Micro	■	■	■	-	-	-	-	-	■	■	■	-	-	-	-	■	-
	Mini	-	-	■	■	■	-	-	-	-	-	■	■	-	-	-	■	■
	Midi	-	-	-	■	■	■	■	-	-	-	■	■	-	-	-	■	■
	Maxi	-	-	-	-	-	■	■	■	-	-	■	■	-	-	-	■	■
Service unit combinations																		
FRC-K 	Micro	-	-	-	-	-	-	-	-	-	-	-	-	-	-	-	-	
	Mini	-	-	■	■	-	-	-	-	-	-	■	■	-	-	-	-	■
	Midi	-	-	-	■	■	■	-	-	-	-	■	■	-	-	-	-	■
	Maxi	-	-	-	-	-	■	■	-	-	-	-	■	■	-	-	-	■
LFR-K LFRS-K 	Micro	-	-	-	-	-	-	-	-	-	-	-	-	-	-	-	-	
	Mini	-	-	■	■	-	-	-	-	-	-	■	■	-	-	-	-	■
	Midi	-	-	-	■	■	■	-	-	-	-	■	■	-	-	-	-	■
	Maxi	-	-	-	-	-	■	■	-	-	-	-	■	■	-	-	-	■
Individual devices																		
Filter regulators LFR/LFRS 	Micro	■	■	■	-	-	-	-	-	■	■	■	-	-	-	-	■	-
	Mini	-	-	■	■	■	-	-	-	-	-	■	■	-	-	-	■	■
	Midi	-	-	-	■	■	■	■	-	-	-	■	■	-	-	-	■	■
	Maxi	-	-	-	-	-	■	■	■	-	-	■	■	-	-	-	■	■
Filters LF 	Micro	■	■	■	-	-	-	-	-	■	■	-	-	-	-	-	■	-
	Mini	-	-	■	■	■	-	-	-	-	-	-	-	-	-	-	■	■
	Midi	-	-	-	■	■	■	■	-	-	-	-	-	-	-	-	■	■
	Maxi	-	-	-	-	-	■	■	■	-	-	-	-	-	-	-	■	■
Fine and micro filters LFMA/LFMB 	Micro	-	-	-	-	-	-	-	-	-	-	-	-	-	-	-	-	-
	Mini	-	-	■	■	■	-	-	-	-	-	-	-	-	■	■	-	-
	Midi	-	-	-	■	■	■	■	-	-	-	-	-	-	■	■	-	-
	Maxi	-	-	-	-	-	■	■	■	-	-	-	-	-	■	■	-	-
Active carbon filters LFX 	Micro	-	-	-	-	-	-	-	-	-	-	-	-	-	-	-	-	-
	Mini	-	-	■	■	■	-	-	-	-	-	-	-	-	-	-	-	-
	Midi	-	-	-	■	■	■	■	-	-	-	-	-	-	-	-	-	-
	Maxi	-	-	-	-	-	■	■	■	-	-	-	-	-	-	-	-	-
Filter combinations LFMBA 	Micro	-	-	-	-	-	-	-	-	-	-	-	-	-	-	-	-	-
	Mini	-	-	■	■	■	-	-	-	-	-	-	-	-	■	■	-	-
	Midi	-	-	-	■	■	■	■	-	-	-	-	-	-	■	■	-	-
	Maxi	-	-	-	-	-	■	■	■	-	-	-	-	-	■	■	-	-
Pressure regulators LR/LRS 	Micro	■	■	■	-	-	-	-	-	■	■	■	-	-	-	-	-	-
	Mini	-	-	■	■	■	-	-	-	-	-	■	■	-	-	-	-	-
	Midi	-	-	-	■	■	■	■	-	-	-	■	■	-	-	-	-	-
	Maxi	-	-	-	-	-	■	■	■	-	-	■	■	-	-	-	-	-

Branching modules FRM/Distributor blocks FRZ, D series, metal design

Product range overview D series service units, metal design

Type	Size	Bowl guard		Condensate drain			Pressure indication		Actuator lock		Supply voltage			Options			→ Page/ Internet
		Metal bowl guard	Plastic bowl	Manual rotary	Semi-automatic	Fully automatic	With pressure gauge	Without pressure gauge	Rotary knob with detent	Rotary knob with integrated lock	24 V DC	110 V AC	230 V AC	Directly actuated pressure regulator with integrated return flow function	Pilot actuated pressure regulator with integrated return flow function	Differential pressure indicator	
Service units																	
FRC/FRCS	Micro	-	■	■	■	-	■	■	■	-	-	-	-	-	-	-	frc
	Mini	■	-	■	-	■	■	■	■	■	-	-	-	-	-	-	
	Midi	■	-	■	-	■	■	■	■	■	-	-	-	-	-	-	
	Maxi	■	-	■	-	■	■	■	■	■	-	-	-	■	■	-	
Service unit combinations																	
FRC-K	Micro	-															frc
	Mini	■	-	■	-	■	■	-	■	-	■	-	-	-	-	-	
	Midi	■	-	■	-	■	■	-	■	-	■	-	-	-	-	-	
	Maxi	■	-	■	-	■	■	-	■	-	■	-	-	■	■	-	
LFR-K LFRS-K	Micro	-															lfr
	Mini	■	-	■	-	■	■	-	■	■	■	-	-	-	-	-	
	Midi	■	-	■	-	■	■	-	■	■	■	-	-	-	-	-	
	Maxi	■	-	■	-	■	■	-	■	■	■	-	-	■	■	-	
Individual devices																	
Filter regulators LFR/LFRS	Micro	-	■	■	■	-	■	■	■	-	-	-	-	-	-	-	lfr
	Mini	■	-	■	-	■	■	■	■	■	-	-	-	-	-	-	
	Midi	■	-	■	-	■	■	■	■	■	-	-	-	-	-	-	
	Maxi	■	-	■	-	■	■	■	■	■	-	-	-	■	■	-	
Filters LF	Micro	-	■	■	■	-	-	-	-	-	-	-	-	-	-	-	lf
	Mini	■	-	■	-	■	-	-	-	-	-	-	-	-	-	-	
	Midi	■	-	■	-	■	-	-	-	-	-	-	-	-	-	-	
	Maxi	■	-	■	-	■	-	-	-	-	-	-	-	-	-	-	
Fine and micro filters LFMA/LFMB	Micro	-															lfma, lfmb
	Mini	■	-	■	-	■	-	-	-	-	-	-	-	-	-	■	
	Midi	■	-	■	-	■	-	-	-	-	-	-	-	-	-	■	
	Maxi	■	-	■	-	■	-	-	-	-	-	-	-	-	-	■	
Active carbon filters LFX	Micro	-															lfx
	Mini	■	-	-	-	-	-	-	-	-	-	-	-	-	-	-	
	Midi	■	-	-	-	-	-	-	-	-	-	-	-	-	-	-	
	Maxi	■	-	-	-	-	-	-	-	-	-	-	-	-	-	-	
Filter combinations LFMBA	Micro	-															lfmba
	Mini	■	-	■	-	■	-	-	-	-	-	-	-	-	-	■	
	Midi	■	-	■	-	■	-	-	-	-	-	-	-	-	-	■	
	Maxi	■	-	■	-	■	-	-	-	-	-	-	-	-	-	■	
Pressure regulators LR/LRS	Micro	-	-	-	-	-	■	■	■	-	-	-	-	-	-	-	lr
	Mini	-	-	-	-	-	■	■	■	■	-	-	-	■	-	-	
	Midi	-	-	-	-	-	■	■	■	■	-	-	-	■	-	-	
	Maxi	-	-	-	-	-	■	■	■	■	-	-	-	■	■	-	

Branching modules FRM/Distributor blocks FRZ, D series, metal design



Product range overview D series service units, metal design

Type	Size	Pneumatic connection										Pressure regulation range [bar]			
		M5	M7	G1/8	G1/4	G3/8	G1/2	G3/4	G1	QS4	QS6	0.5 ... 7	0.5 ... 12		
Individual devices															
Pressure regulators LRB/LRBS		Micro	-												
		Mini	-	-	-	■	-	-	-	-	-	-	-	■	■
		Midi	-	-	-	-	■	-	-	-	-	-	-	■	■
		Maxi	-												
Pressure regulator combinations LRB-K		Micro	-												
		Mini	-	-	-	■	■	-	-	-	-	-	-	■	■
		Midi	-	-	-	-	■	■	-	-	-	-	-	■	■
		Maxi	-												
Lubricators LOE		Micro	■	■	■	-	-	-	-	-	■	■	-	-	
		Mini	-	-	■	■	■	-	-	-	-	-	-	-	
		Midi	-	-	-	■	■	■	■	-	-	-	-	-	
		Maxi	-	-	-	-	-	■	■	■	-	-	-	-	
On-off valves HE		Micro	-												
		Mini	-	-	■	■	■	-	-	-	-	-	-	-	
		Midi	-	-	-	■	■	■	■	-	-	-	-	-	
		Maxi	-	-	-	-	-	■	■	■	-	-	-	-	
On-off valves, electrical HEE		Micro	-												
		Mini	-	-	■	■	■	-	-	-	-	-	-	-	
		Midi	-	-	-	■	■	■	■	-	-	-	-	-	
		Maxi	-	-	-	-	-	■	■	■	-	-	-	-	
On-off valves, pneumatic HEP		Micro	-												
		Mini	-	-	■	■	■	-	-	-	-	-	-	-	
		Midi	-	-	-	■	■	■	■	-	-	-	-	-	
		Maxi	-	-	-	-	-	■	■	■	-	-	-	-	
Soft-start valves HEL		Micro	-												
		Mini	-	-	■	■	■	-	-	-	-	-	-	-	
		Midi	-	-	-	■	■	■	■	-	-	-	-	-	
		Maxi	-	-	-	-	-	■	■	■	-	-	-	-	
Membrane air dryers LDM1		Micro	-												
		Mini	-												
		Midi	-												
		Maxi	-	-	-	-	-	■	■	■	-	-	-	-	
Branching modules FRM		Micro	-												
		Mini	-	-	■	■	■	-	-	-	-	-	-	-	
		Midi	-	-	-	■	■	■	■	-	-	-	-	-	
		Maxi	-	-	-	-	-	■	■	■	-	-	-	-	
Distributor block FRZ		Micro	-												
		Mini	-	-	-	-	-	-	-	-	-	-	-	-	
		Midi	-	-	-	-	-	-	-	-	-	-	-	-	
		Maxi	-	-	-	-	-	-	-	-	-	-	-	-	

Branching modules FRM/Distributor blocks FRZ, D series, metal design

Product range overview D series service units, metal design

Type	Size	Bowl guard		Pressure indication		Actuator lock		Supply voltage			Options		→ Page/ Internet
		Metal bowl guard	Plastic bowl	With pressure gauge	Without pressure gauge	Rotary knob with detent	Rotary knob with integrated lock	24 V DC	110 V AC	230 V AC	Non-return function	Pressure switch	
Individual devices													
Pressure regulators LRB/LRBS	Micro	-	-	-	■	■	■	-	-	-	-	-	lrb
	Mini	-	-	-	■	■	■	-	-	-	-	-	
	Midi	-	-	-	■	■	■	-	-	-	-	-	
	Maxi	-	-	-	■	■	■	-	-	-	-	-	
Pressure regulator combinations LRB-K	Micro	-	-	-	■	■	-	-	-	-	-	-	lrb
	Mini	-	-	-	■	■	-	-	-	-	-	-	
	Midi	-	-	-	■	■	-	-	-	-	-	-	
	Maxi	-	-	-	■	■	-	-	-	-	-	-	
Lubricators LOE	Micro	-	■	-	■	-	-	-	-	-	-	-	loe
	Mini	■	-	-	■	-	-	-	-	-	-	-	
	Midi	■	-	-	■	-	-	-	-	-	-	-	
	Maxi	■	-	-	■	-	-	-	-	-	-	-	
On-off valves HE	Micro	-	-	-	■	■	-	-	-	-	-	-	he
	Mini	-	-	-	■	■	-	-	-	-	-	-	
	Midi	-	-	-	■	■	-	-	-	-	-	-	
	Maxi	-	-	-	■	■	-	-	-	-	-	-	
On-off valves, electrical HEE	Micro	-	-	-	■	-	-	■	■	■	-	-	hee
	Mini	-	-	-	■	-	-	■	■	■	-	-	
	Midi	-	-	-	■	-	-	■	■	■	-	-	
	Maxi	-	-	-	■	-	-	■	■	■	-	-	
On-off valves, pneumatic HEP	Micro	-	-	-	■	-	-	-	-	-	-	-	hep
	Mini	-	-	-	■	-	-	-	-	-	-	-	
	Midi	-	-	-	■	-	-	-	-	-	-	-	
	Maxi	-	-	-	■	-	-	-	-	-	-	-	
Soft-start valves HEL	Micro	-	-	-	■	-	-	-	-	-	-	-	hel
	Mini	-	-	-	■	-	-	-	-	-	-	-	
	Midi	-	-	-	■	-	-	-	-	-	-	-	
	Maxi	-	-	-	■	-	-	-	-	-	-	-	
Membrane air dryers LDM1	Micro	-	-	-	■	-	-	-	-	-	-	-	ldm1
	Mini	-	-	-	■	-	-	-	-	-	-	-	
	Midi	-	-	-	■	-	-	-	-	-	-	-	
	Maxi	■	-	-	■	-	-	-	-	-	-	-	
Branching modules FRM	Micro	-	-	-	■	-	-	-	-	-	■	■	6
	Mini	-	-	-	■	-	-	-	-	-	■	■	
	Midi	-	-	-	■	-	-	-	-	-	■	■	
	Maxi	-	-	-	■	-	-	-	-	-	■	■	
Distributor block FRZ	Micro	-	-	-	■	-	-	-	-	-	-	-	12
	Mini	-	-	-	■	-	-	-	-	-	-	-	
	Midi	-	-	-	■	-	-	-	-	-	-	-	
	Maxi	-	-	-	■	-	-	-	-	-	-	-	

Branching modules FRM, D series, metal design

Peripherals overview

FESTO

Mini/Midi/Maxi

Individual unit with connection plates

Individual unit without connection plates, for service unit combination

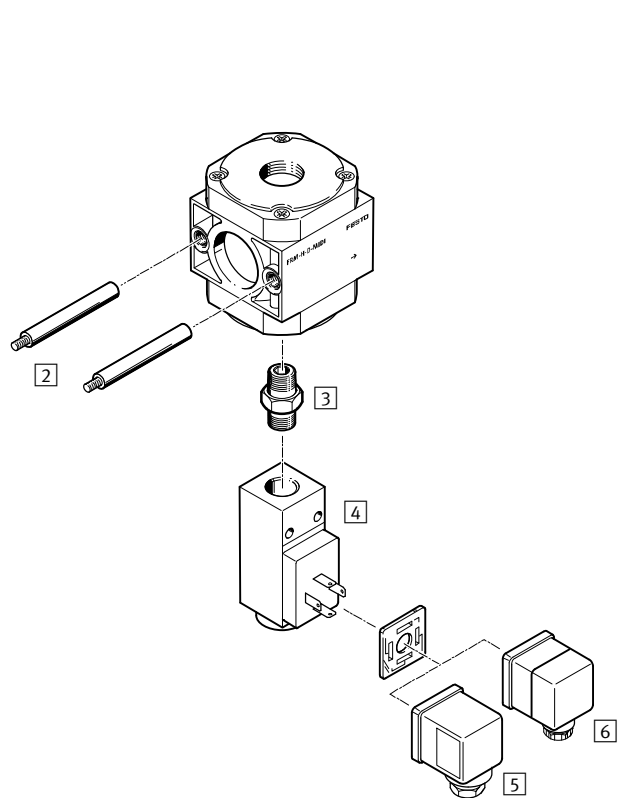
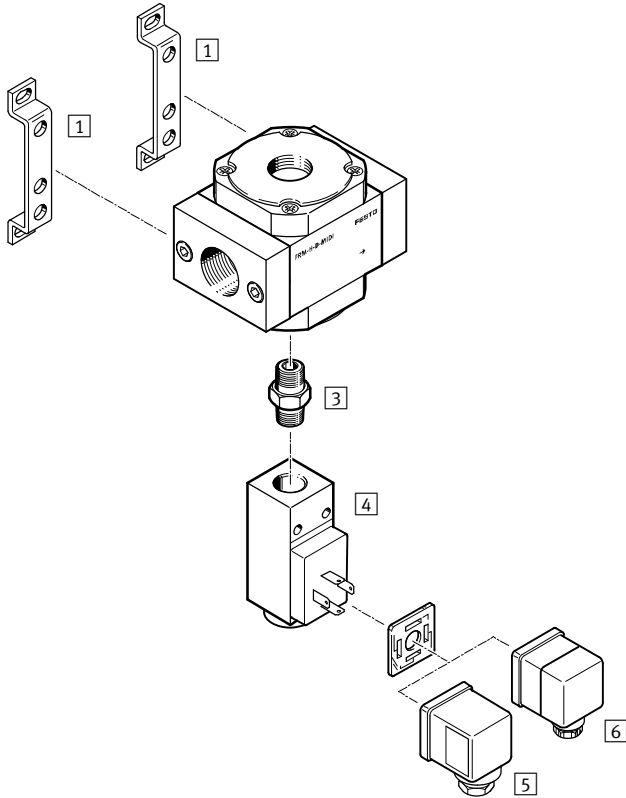

Mounting attachments and accessories

	Individual unit		Combination		→ Page/ Internet
	with connection plates	without connection plates	with connection plates	without connection plates	
[1] Mounting bracket HFOE	■	-	■	-	hfoe-d
[2] Threaded pin (included in scope of delivery) FRB	-	-	■	■	frb-d
[3] Double nipple ESK	■	■	■	■	14
[4] Pressure switches PEV	■	■	■	■	14
[5] Plug socket MSSD-C	■	■	■	■	14
[6] Angled plug socket PEV-...-WD-LED	■	■	■	■	14

Branching modules FRM, D series, metal design

Type codes

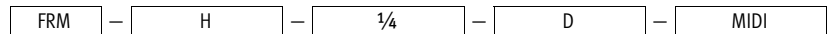

Basic function

FRM	Branching module
-----	------------------

Branching module

	Standard
H	With integrated non-return function
Y	With pressure switch (not with connecting plates)

Pneumatic connection

MINI/MIDI/MAXI	
	Without connecting plates

MINI	
1/8	Connecting plates with thread G1/8
1/4	Connecting plates with thread G1/4
3/8	Connecting plates with thread G3/8

MIDI	
1/4	Connecting plates with thread G1/4
3/8	Connecting plates with thread G3/8
1/2	Connecting plates with thread G1/2
3/4	Connecting plates with thread G3/4

MAXI	
1/2	Connecting plates with thread G1/2
3/4	Connecting plates with thread G3/4
1	Connecting plates with thread G1

Series

D	Series
---	--------

Size

MINI	Grid dimension 40 mm (without connecting plates)
Midi	Grid dimension 55 mm (without connecting plates)
MAXI	Grid dimension 66 mm (without connecting plates)

Branching modules FRM, D series, metal design

Technical data

Function
Branching module, standard

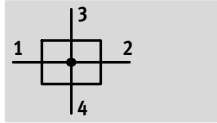

Branching module with integrated non-return function

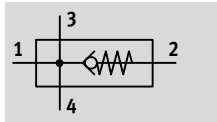

- - Flow rate
1100 ... 20,000 l/min
- - Temperature range
-10 ... +60 °C
- - Operating pressure
0 ... 16 bar



- Branching module for compressed air distribution for attachment of auxiliary modules (pressure regulator, pressure switch, etc....)
- An integrated non-return valve prevents the return flow of lubricated compressed air
- Several additional air connections for greater flexibility
- Can be used as an intermediate distributor for varying air qualities

General technical data													
Size	Mini				Midi					Maxi			
Pneumatic connection 1, 2	G1/8	G1/4	G3/8	- ¹⁾	G1/4	G3/8	G1/2	G3/4	- ¹⁾	G1/2	G3/4	G1	- ¹⁾
Pneumatic connection 3	G1/4				G1/2					G3/4			
Pneumatic connection 4	G1/4												
Design	Branching module												
Type of mounting	Via accessories												
	In-line installation												
Mounting position	Any												
Air quality class at the outlet port	Compressed air according to ISO 8573-1:2010 [7:-:-]												
	Inert gases												

1) Without connecting plates.

- - Note: This product conforms to ISO 1179-1 and to ISO 228-1

Standard nominal flow rate $q_{nN}^{1)}$ [l/min]														
Size	Mini				Midi					Maxi				
Pneumatic connection	G1/8	G1/4	G3/8	- ²⁾	G1/4	G3/8	G1/2	G3/4	- ²⁾	G1/2	G3/4	G1	- ²⁾	
Branching module, standard														
In main flow direction 1 \rightarrow 2	1400	3300	2900	3300	3300	6700	8200	8800	8200	11,700	20,000	17,400	20,000	
Branching module with integrated non-return function														
In main flow direction 1 \rightarrow 2	1100	2000	2100	2000	3100	4900	5100	5000	5100	9000	13,500	12,300	13,500	
Branching module with pressure switch														
In main flow direction 1 \rightarrow 2	-			3300	-				8200	-		20,000		

1) Measured at $p_1 = 6 \text{ bar}$ and $\Delta p = 1 \text{ bar}$.

2) Without connecting plates.

Branching modules FRM, D series, metal design

Technical data

Operating and environmental conditions						
Branching module	Standard		With integrated non-return function			With pressure switch
Size	Mini/Midi/Maxi		Mini	Midi	Maxi	Mini/Midi/Maxi
Operating pressure [bar]	0 ... 16		0.15 ... 16	0.2 ... 16	0.25 ... 16	0 ... 12
Operating medium	Compressed air according to ISO 8573-1:2010 [7:-:-]					
	Inert gases					
Ambient temperature [°C]	-10 ... +60					
Temperature of medium [°C]	-10 ... +60					
Storage temperature [°C]	-10 ... +60					
Corrosion resistance class CRC ¹⁾	2					
Approval certificate	Germanischer Lloyd					

1) Corrosion resistance class CRC 2 to Festo standard FN 940070
 Moderate corrosion stress. Indoor applications in which condensation may occur. External visible parts with primarily decorative requirements for the surface and which are in direct contact with the ambient atmosphere typical for industrial applications.

Weight [g]													
Size	Mini				Midi						Maxi		
Pneumatic connection	G ¹ / ₈	G ¹ / ₄	G ³ / ₈	- ¹⁾	G ¹ / ₄	G ³ / ₈	G ¹ / ₂	G ³ / ₄	- ¹⁾	G ¹ / ₂	G ³ / ₄	G1	- ¹⁾
Branching module, standard													
FRM-D	207	197	207	127	532	522	502	472	382	702	662	772	442
Branching module with integrated non-return function													
FRM-H-D	208	198	208	128	536	526	506	476	386	706	666	776	446
Branching module with pressure switch													
FRM-Y-D	-			376	-				550	-		758	

1) Without connecting plates.

Materials

Sectional view

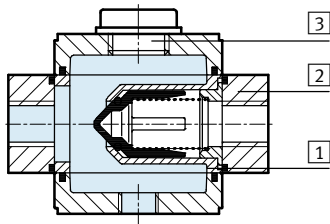

Branching module		
1	Housing	Die-cast zinc
2	Connecting plates	Die-cast zinc
3	Blanking screw	Galvanised steel
-	Seals	NBR
Note on materials		RoHS-compliant
		Free of copper and PTFE

Branching modules FRM, D series, metal design

Technical data

FESTO

Dimensions Download CAD data → www.festo.com

Connecting plates with thread Without connecting plates

4 Threaded bolt (exchangeable) → Flow direction

Type	B1	B2	B3	B4	B5	D1	D2	D3	D6	H1	H2	L1	L2	T1	T2
Mini															
FRM-1/8-D-MINI	64	52	40	30	-	G1/8	-	M4	G1/4	20	11	42	7	7	-
FRM-1/4-D-MINI						G1/4									
FRM-3/8-D-MINI						G3/8									
FRM-D-MINI	-	-	-	-	5.8	-	11	-	-	-	-	-	-	-	10
Midi															
FRM-1/4-D-MIDI	85	70	55	43	-	G1/4	-	M5	G1/2	32	22	59	8	8	-
FRM-3/8-D-MIDI						G3/8									
FRM-1/2-D-MIDI						G1/2									
FRM-3/4-D-MIDI						G3/4									
FRM-D-MIDI	-	-	-	-	6.8	-	24	-	-	-	-	-	-	-	11
Maxi															
FRM-1/2-D-MAXI	96	80	66	46	-	G1/2	-	M5	G3/4	32	22	70	8	8	-
FRM-3/4-D-MAXI						G3/4									
FRM-1-D-MAXI						G1									
FRM-D-MAXI	-	-	-	-	6.8	-	30	-	-	-	-	-	-	-	11

Note: This product conforms to ISO 1179-1 and to ISO 228-1

Dimensions – Pressure switch Download CAD data → www.festo.com

Pressure switch with adjustable pressure switching point Technical data → Internet: pev-1/4

Pressure switch PEV-1/4-B-OD with adjustable pressure switching point, plug connector, square design to EN 175 301, type A

Type	B6	B7	L3
FRM-Y-D-MINI	20	62	92.3
FRM-Y-D-MIDI	27.5	69.5	92.3
FRM-Y-D-MAXI	33	75	92.3

Branching modules FRM, D series, metal design

Technical data

Ordering data							
Size	Connection	Branching module, standard		Branching module with integrated non-return function		Branching module with pressure switch PEV-1/4-B-0D	
		Part No.	Type	Part No.	Type	Part No.	Type
Without connecting plates							
Mini	–	170684	FRM-D-MINI	170687	FRM-H-D-MINI	542184	FRM-Y-D-MINI
Midi	–	170685	FRM-D-MIDI	170688	FRM-H-D-MIDI	542185	FRM-Y-D-MIDI
Maxi	–	170686	FRM-D-MAXI	170689	FRM-H-D-MAXI	542186	FRM-Y-D-MAXI
Connecting plates with thread							
Mini	G1/8	164949	FRM-1/8-D-MINI	162788	FRM-H-1/8-D-MINI	–	–
	G1/4	164950	FRM-1/4-D-MINI	162789	FRM-H-1/4-D-MINI	–	–
	G3/8	164951	FRM-3/8-D-MINI	162790	FRM-H-3/8-D-MINI	–	–
Midi	G1/4	186523	FRM-1/4-D-MIDI	186525	FRM-H-1/4-D-MIDI	–	–
	G3/8	164952	FRM-3/8-D-MIDI	162791	FRM-H-3/8-D-MIDI	–	–
	G1/2	164953	FRM-1/2-D-MIDI	162792	FRM-H-1/2-D-MIDI	–	–
	G3/4	164954	FRM-3/4-D-MIDI	162793	FRM-H-3/4-D-MIDI	–	–
Maxi	G1/2	186524	FRM-1/2-D-MAXI	186526	FRM-H-1/2-D-MAXI	–	–
	G3/4	164955	FRM-3/4-D-MAXI	162794	FRM-H-3/4-D-MAXI	–	–
	G1	164956	FRM-1-D-MAXI	162795	FRM-H-1-D-MAXI	–	–

Distributor blocks FRZ, D series, metal design

Type codes

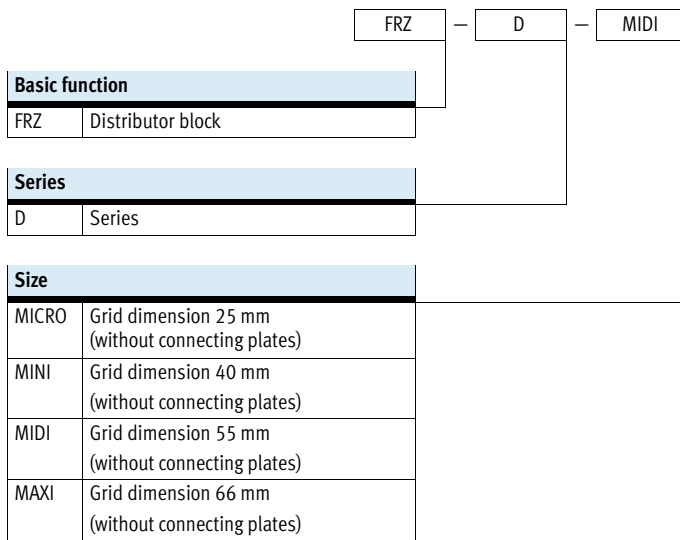

Distributor blocks FRZ, D series, metal design

Technical data

FRZ-D-MICRO

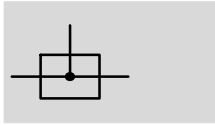

FRZ-D-MINI/MIDI/MAXI

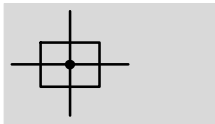

Additional air connections can be used to branch off filtered, unlubricated compressed air, e.g. to supply air barriers, sensors and control systems, or for especially clean air in combination with micro filter LFM.

Materials:
Housing: Aluminium
Cover plate: Galvanised steel

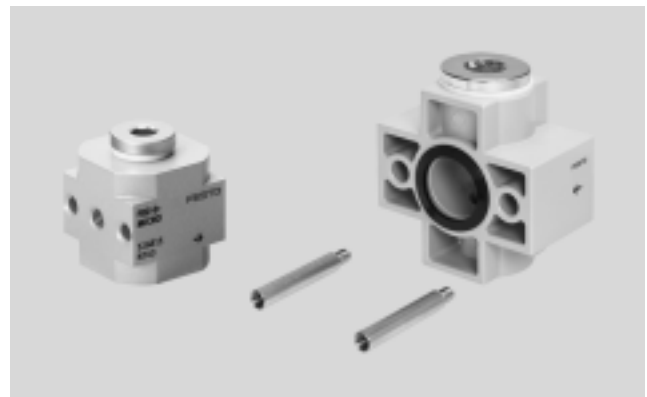

Dimensions Download CAD data → www.festo.com

Micro Mini/Midi/Maxi

4 Threaded pin (exchangeable) → Flow direction

Type	B1	B2	B3	B4	B5	D1 ∅	D2	D3	D4	T2
Mini										
FRZ-D-MINI	30	20	40	30	6	12	G $\frac{1}{4}$	M4	G $\frac{1}{4}$	12
Midi										
FRZ-D-MIDI	35	32	55	43	7	16	G $\frac{1}{4}$	M5	G $\frac{1}{2}$	8
Maxi										
FRZ-D-MAXI	40	32	65	46	7	22	G $\frac{1}{4}$	M5	G $\frac{3}{4}$	10



• Note: This product conforms to ISO 1179-1 and to ISO 228-1

Ordering data		
Distributor block		
Size	Part No.	Type
Without threaded connecting plates		
Micro	526815	FRZ-D-MICRO
Mini	162786	FRZ-D-MINI
Midi	159592	FRZ-D-MIDI
Maxi	162787	FRZ-D-MAXI

Branching modules FRM/Distributor blocks FRZ, D series

FESTO

Accessories

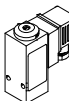
Ordering data – Pressure switch PEV				Technical data → Internet: pev-1/4	
	Pneumatic connection	Pressure switching point	Electrical connection	Part No.	Type
	G1/4	Adjustable with visual scale	Plug, square design to DIN EN 175 301, type A	161760	PEV-1/4-SC-0D
	G1/4	Adjustable	Plug, square design to DIN EN 175 301, type A	175250	PEV-1/4-B-0D
	G1/4	Adjustable	Plug socket MSSD-C-4P	10773	PEV-1/4-B

Ordering data – Angled socket PEV					Technical data → Internet: pev-1/4	
	Description	Operating voltage range	Electrical connection	Switching status display	Part No.	Type
	for PEV-1/4-...-OD	15 ... 30 V DC	4-pin	Yellow LED	164274	PEV-1/4-WD-LED-24
		≤ 230 V AC	4-pin	Yellow LED	164275	PEV-1/4-WD-LED-230
		≤ 180 V DC				

Ordering data – Plug socket MSSD-C-4P					Technical data → Internet: mssd-c-4p	
	Description	Operating voltage range	Electrical connection	Type of mounting cable connection	Part No.	Type
	for PEV-1/4-...-OD	≤ 250 V AC/DC	3-pin	Clamping screws	171157	MSSD-C-4P

Ordering data – Double nipple ESK					
	Description	Pneumatic connection		Part No.	Type
	Adjustable for angular compensation • For retro-fitting pressure switch PEV to branching module FRM	R1/4	R1/4	151521	ESK-1/4-1/4