

Servo motors EMME-AS

FESTO



Servo motors EMME-AS

Key features

Everything from a single source

Motors EMME-AS

→ 3



- Brushless, permanently excited synchronous servo motors
- Reliable, dynamic, precise
- Choice of feedback systems:
 - Digital single-turn absolute displacement encoder
 - Digital multi-turn absolute displacement encoder
- Optimised connection technology
- Winding variants
 - For single-phase motor controller
 - For three-phase motor controller
 - Speed-optimised
- Protection class: IP21 (motor shaft)
- Protection class: IP65 (motor housing and connection technology)
- Optional:
 - Holding brake

Gear units EMGA-EAS/-SAS

→ 14



- Low-backlash planetary gear unit
- Gear ratio $i = 3$ and 5 , available ex-stock
- Life-time lubrication
- Protection class: IP54
- Other gear unit types, ratios, designs and versions on request

Motor controllers CMMP-AS

→ Internet: cmm



- Digital servo controller (0.5 kVA ... 12 kVA)
- Actuation of AC servo and linear motors
- Integrated EMC filters
- Integrated brake chopper
- Integrated safety functions
- Position controller with closed-loop position control (256 position sets)
- Speed controller
- Torque control via current controller
- Range of control functions
- Interfaces:
 - I/O interface
 - CANopen, standard
 - PROFIBUS DP, optional module
 - DeviceNet, optional module
 - PROFINET RT, optional module
 - EtherCAT, optional module
 - EtherNet/IP, optional module

Motor and encoder cables NEBM

→ 16



- Suitable for use with energy chains
- Connection technology on motor side with protection to IP65
- Can be used in a wide temperature range

Axial and parallel kits EAMM

→ Internet: eamm



- Defined kits for all electromechanical axes from Festo
- Each kit includes the relevant necessary coupling housing, couplings and motor flange as well as all screws
- Optionally with protection to IP65

Servo motors EMME-AS

Type codes

		EMME	–	AS	–	60	–	S	–	LS	–	AM
Type												
EMME	Motor											
Motor type												
AS	Servo motor											
Motor flange size												
40	40 mm											
60	60 mm											
80	80 mm											
100	100 mm											
Length												
S	Short											
M	Medium											
Winding												
LS	Low-voltage, standard											
LV	Low-voltage, speed-optimised											
HS	High-voltage, standard											
Electrical connection												
A	Angled plug, fixed – outlet direction: shaft											
Measuring unit												
S	Absolute encoder, single-turn											
M	Absolute encoder, multi-turn											
Brake												
–	None											
B	With brake											

Servo motors EMME-AS

Technical data



 Note

Motors and motor controllers from Festo are specially matched to each other. Fault-free operation cannot be guaranteed in combination with third-party controllers.



Technical data			
Flange size		40	
Length		S	M
Winding		LV	LV
Motor			
Nominal voltage	[V DC]	360	360
Nominal current	[A]	0.7	1.2
Continuous current at standstill	[A]	0.8	1.6
Peak current	[A]	3.2	6.4
Rated output	[W]	110	200
Nominal torque	[Nm]	0.12	0.21
Peak torque	[Nm]	0.7	1.4
Torque at standstill	[Nm]	0.18	0.35
Nominal rotational speed	[rpm]	9,000	9,000
Max. rotational speed	[rpm]	10,000	10,000
Motor constant	[Nm/A]	0.171	0.175
Winding resistance	[Ω]	25.6	8.6
Winding inductance	[mH]	14.8	6.6
Total moment of inertia of drive output			
Without brake	[kgcm ²]	0.03	0.054
With brake	[kgcm ²]	0.055	0.079
Shaft load at nominal rotational speed			
Radial	[N]	105	115
Axial	[N]	21	23
Brake			
Operating voltage	[V DC]	24 +6 ... -10%	
Output	[W]	8	
Holding torque	[Nm]	0.4	
Mass moment of inertia	[kgcm ²]	0.014	

Servo motors EMME-AS

Technical data

Technical data			
Flange size		60	
Length		S	M
Winding		LS	LS
Motor			
Nominal voltage	[V DC]	360	360
Nominal current	[A]	0.8	1.5
Continuous current at standstill	[A]	0.9	1.8
Peak current	[A]	3.6	7.2
Rated output	[W]	190	380
Nominal torque	[Nm]	0.6	1.2
Peak torque	[Nm]	2.8	6.0
Torque at standstill	[Nm]	0.7	1.5
Nominal rotational speed	[rpm]	3,000	3,000
Max. rotational speed	[rpm]	5,131	4,925
Motor constant	[Nm/A]	0.75	0.80
Winding resistance	[Ω]	26.4	9.8
Winding inductance	[mH]	37.6	18.6
Total moment of inertia of drive output			
Without brake	[kgcm ²]	0.22	0.413
With brake	[kgcm ²]	0.319	0.512
Shaft load at nominal rotational speed			
Radial	[N]	250	270
Axial	[N]	50	54
Brake			
Operating voltage	[V DC]	24 +6 ... -10%	
Output	[W]	11	
Holding torque	[Nm]	2	
Mass moment of inertia	[kgcm ²]	0.086	

Servo motors EMME-AS

Technical data

Technical data					
Flange size		80			
Length		S		M	
Winding		LS	HS	LS	HS
Motor					
Nominal voltage	[V DC]	360	565	360	565
Nominal current	[A]	2.6	1.6	3.7	2.1
Continuous current at standstill	[A]	3.1	1.8	3.9	2.2
Peak current	[A]	12.4	7.2	15.6	8.8
Rated output	[W]	750	720	1,000	1,000
Nominal torque	[Nm]	2.4	2.3	3.2	3.2
Peak torque	[Nm]	11.2	11.2	14.0	14.0
Torque at standstill	[Nm]	2.8	2.8	3.5	3.5
Nominal rotational speed	[rpm]	3,000	3,000	3,000	3,000
Max. rotational speed	[rpm]	4,690	4,192	4,627	4,097
Motor constant	[Nm/A]	0.923	1.438	0.865	1.524
Winding resistance	[Ω]	4.6	14.2	2.8	9.0
Winding inductance	[mH]	11.8	36.2	8.4	26.0
Total moment of inertia of drive output					
Without brake	[kgcm ²]	1.4		1.93	
With brake	[kgcm ²]	1.68		2.2	
Shaft load at nominal rotational speed					
Radial	[N]	350		360	
Axial	[N]	70		72	
Brake					
Operating voltage	[V DC]	24 +6 ... -10%		24 +6 ... -10%	
Output	[W]	12		12	
Holding torque	[Nm]	4.5		4.5	
Mass moment of inertia	[kgcm ²]	0.222		0.222	

Servo motors EMME-AS

Technical data

Technical data			
Flange size		100	
Length		S	M
Winding		HS	HS
Motor			
Nominal voltage	[V DC]	565	565
Nominal current	[A]	3.0	4.1
Continuous current at standstill	[A]	3.4	4.6
Peak current	[A]	13.6	18.4
Rated output	[W]	1,500	2,000
Nominal torque	[Nm]	4.8	6.4
Peak torque	[Nm]	22.4	30.0
Torque at standstill	[Nm]	5.6	7.5
Nominal rotational speed	[rpm]	3,000	3,000
Max. rotational speed	[rpm]	3,910	3,941
Motor constant	[Nm/A]	1.6	1.561
Winding resistance	[Ω]	4.6	3.2
Winding inductance	[mH]	19.8	15.0
Total moment of inertia of drive output			
Without brake	[kgcm ²]	4.84	6.41
With brake	[kgcm ²]	5.63	7.2
Shaft load at nominal rotational speed			
Radial	[N]	650	680
Axial	[N]	130	136
Brake			
Operating voltage	[V DC]	24 +6 ... -10%	
Output	[W]	18	
Holding torque	[Nm]	9.0	
Mass moment of inertia	[kgcm ²]	0.654	

Servo motors EMME-AS

Technical data

Technical data – Encoder		
Measuring unit	Absolute, single-turn (SEK 34/37)	Absolute, multi-turn (SEL 34/37)
Operating voltage	[V DC]	7 ... 12 (±5%)
Interface signals/protocol– HIPERFACE®		
Process data channel	SIN, REFSIN, COS, REFCOS (analogue differential)	
Sinusoidal/cosinusoidal periods per revolution	16	
Parameter channel	RS485 (digital)	
Absolute position values per revolution	512 (resolution 9 bit)	
Maximum speed		
For absolute value generation	[1/min]	6,000
Mechanical	[1/min]	12,000
Revolutions	1	4,096 revolutions, 12 bits
Interpolation of sine/cosine signals in the motor controller ¹⁾		
Measurement step at 12 bit	20" (angular seconds)	
Angular accuracy	±20' (angular minutes)	

1) Dependent on the motor controller.

Weight [kg]								
Flange size	40		60		80		100	
Length	S	M	S	M	S	M	S	M
Without brake	0.6	0.7	1.7	2.2	3.4	4.1	6.3	7.3
With brake	0.7	0.8	2.0	2.6	4.1	4.8	7.3	8.3

Operating and environmental conditions	
Standard	IEC60034
Protection class	
Motor shaft	IP21
Motor shaft and connection technology	IP65
Ambient temperature	[°C] –10 ... +40 (up to 100 °C with derating of 1.5% per degree Celsius)
Storage temperature	[°C] –20 ... +70
Insulation protection class	F (155 °C)
Temperature monitoring	Not integrated, only via I ² t temperature monitoring model of the motor controller
Rated class to EN 60034-1	S1 (continuous operation)
Thermal class to EN 60034-1	F (155 °C)
Relative air humidity	[%] 0 ... 90 (non-condensing)
CE marking (see declaration of conformity)	To EU Low Voltage Directive To EU EMC Directive ¹⁾
Certification	cULus Recognized (OL) C-Tick
Note on materials	RoHS-compliant Contains PWIS (paint-wetting impairment substances)

1) For information about the applicability of the component see the manufacturer's EC declaration of conformity at: www.festo.com → Support → User documentation.
If the component is subject to restrictions on usage in residential, office or commercial environments or small businesses, further measures to reduce the emitted interference may be necessary.

Servo motors EMME-AS

Technical data

Pin allocation – Motor side

Motor (M16, pins)

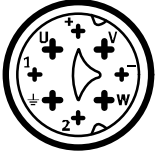

Pin	Function
U	Phase U
V	Phase V
W	Phase W
⊥	Protective earth (PE)
+	Brake BR+
-	Brake BR-
1	n.c.
2	n.c.

Encoder (M12, pins)

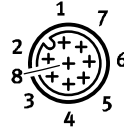

Pin	Function
1	0 V
2	Us (7 ... 12 V DC)
3	Data+ (RS485)
4	Data- (RS485)
5	SIN+
6	SIN- (REFSIN)
7	COS+
8	COS- (REFCOS)

Torque M as a function of rotational speed n

Flange size 40

Length S
Winding LV

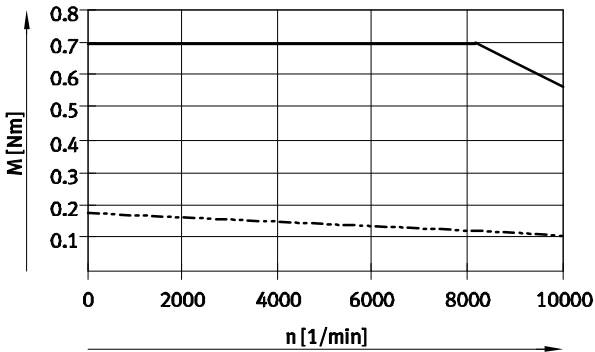

Length M
Winding LV

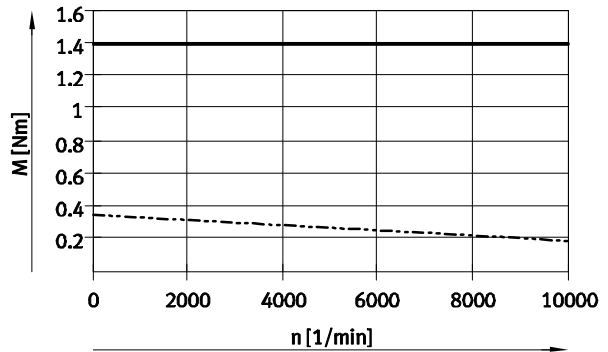

Flange size 60

Length S
Winding LS

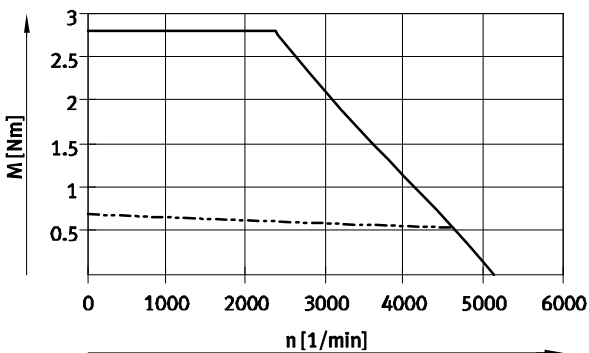

Length M
Winding LS

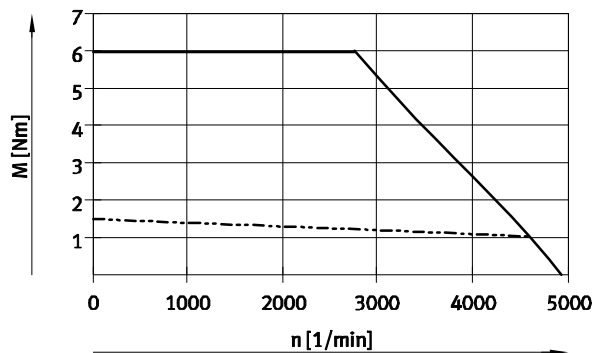

— Peak torque
- - - Nominal torque

Note

Typical motor characteristic curve with nominal voltage and optimal controller.

Servo motors EMME-AS

Technical data

Torque M as a function of rotational speed n

Flange size 80

Length S

Winding LS

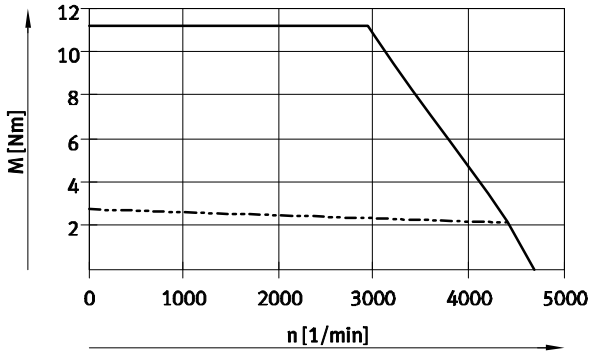

Length S

Winding HS

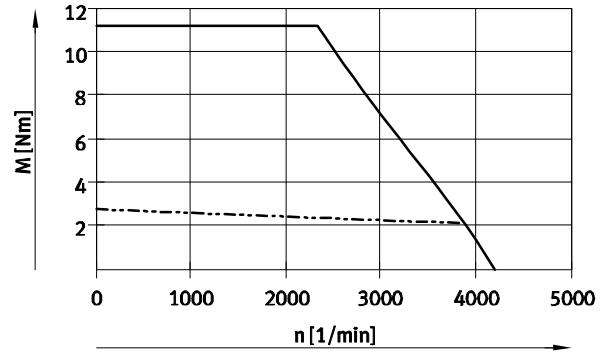

Flange size 80

Length M

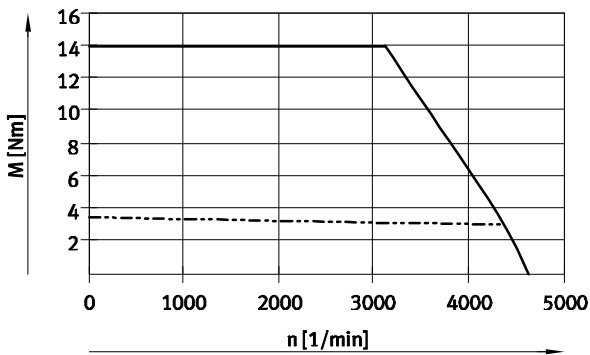

Winding LS

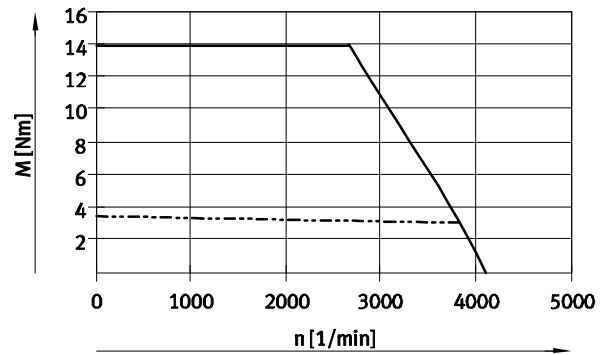

Length M

Winding HS



-  Peak torque
-  Nominal torque

 Note

Typical motor characteristic curve with nominal voltage and optimal controller.

Servo motors EMME-AS

Technical data

Torque M as a function of rotational speed n

Flange size 100

Length S
Winding HS

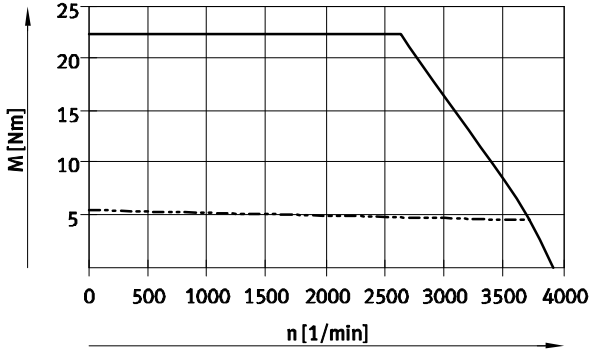

Length M
Winding HS

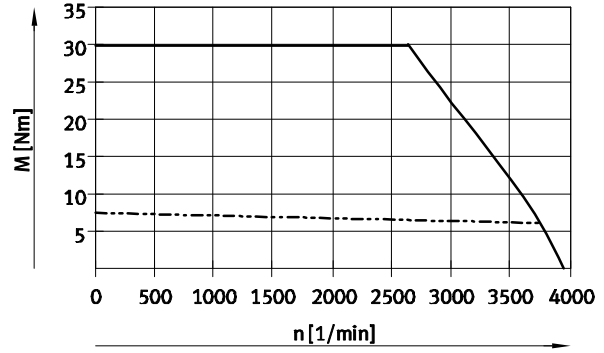

— Peak torque
- - - Nominal torque

 Note

Typical motor characteristic curve with nominal voltage and optimal controller.

Servo motors EMME-AS

Technical data

Dimensions

Download CAD data → www.festo.com

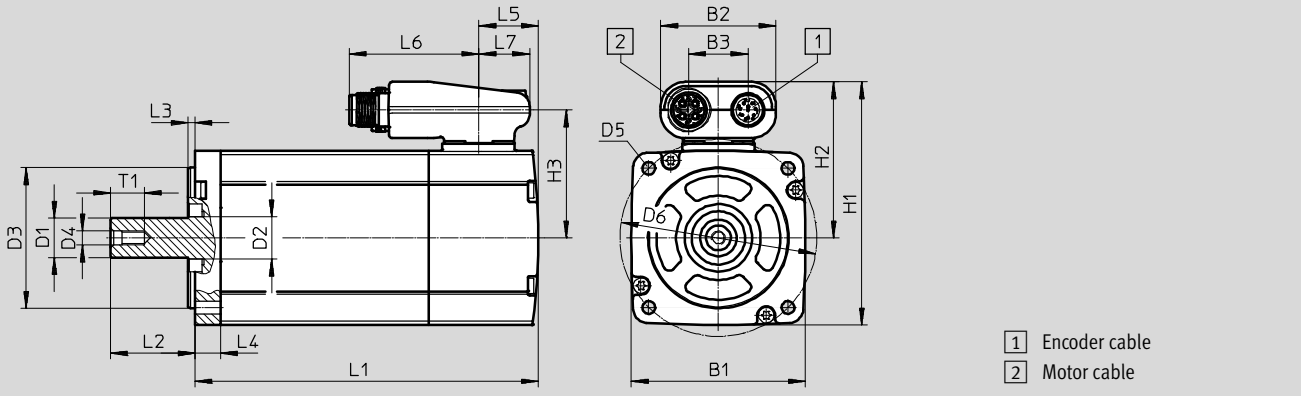

Flange size	Length	B1	B2	B3	D1 ∅ h6	D2 ∅	D3 ∅ h7	D4
40	S	40	41	21	8	10	30	M3
	M							
60	S	62	41	21	14	15	50	M5
	M							
80	S	82	41	21	19	20	70	M6
	M							
100	S	102	41	21	19	25	95	M6
	M							

Flange size	Length	D5 ∅	D6 ∅ ±0.3	H1	H2	H3	L1	
							±2	With brake ±2
40	S	3.4	45	68.5	48.5	38.5	89	124
	M							
60	S	4.5	70	86.5	55.5	45.5	122	156
	M							
80	S	5.5	90	106.5	65.5	55.5	158	200
	M							
100	S	9	115	126.5	75.5	65.5	200	242
	M							

Flange size	Length	L2	L3 ±0.2	L4 ±0.3	L5	L6	L7	T1
40	S	20+0.5/-0.7	2.5	4.5	25.3	46.2	18	9
	M							
60	S	30+0.5/-0.2	2.5	9	21	46.2	18	12.5
	M							
80	S	35+0.4/-0.2	3	10	23	46.2	18	16
	M							
100	S	40+0.4/-0.2	3	12	25.5	46.2	18	16
	M							

Servo motors EMME-AS

Technical data

Ordering data – Stock items								Part No.	Type
Length		Winding			Measuring unit		Brake		
Short	Medium	Low-voltage, standard	Low-voltage, speed-optimised	High-voltage, standard	Encoder, single-turn	Encoder, multi-turn			
Flange size 40									
■			■		■			2082428	EMME-AS-40-S-LV-AS
■			■		■		■	2082430	EMME-AS-40-S-LV-ASB
■			■			■		2082429	EMME-AS-40-S-LV-AM
■			■			■	■	2082431	EMME-AS-40-S-LV-AMB
	■		■		■			2082444	EMME-AS-40-M-LV-AS
	■		■		■		■	2082446	EMME-AS-40-M-LV-ASB
	■		■			■		2082445	EMME-AS-40-M-LV-AM
	■		■			■	■	2082447	EMME-AS-40-M-LV-AMB
Flange size 60									
■		■			■			2089698	EMME-AS-60-S-LS-AS
■		■			■		■	2089700	EMME-AS-60-S-LS-ASB
■		■				■		2089699	EMME-AS-60-S-LS-AM
■		■				■	■	2089701	EMME-AS-60-S-LS-AMB
	■	■			■			2089730	EMME-AS-60-M-LS-AS
	■	■			■		■	2089732	EMME-AS-60-M-LS-ASB
	■	■				■		2089731	EMME-AS-60-M-LS-AM
	■	■				■	■	2089733	EMME-AS-60-M-LS-AMB
Flange size 80									
■		■			■			2093104	EMME-AS-80-S-LS-AS
■		■			■		■	2093106	EMME-AS-80-S-LS-ASB
■		■				■		2093105	EMME-AS-80-S-LS-AM
■		■				■	■	2093107	EMME-AS-80-S-LS-AMB
■				■	■			2093136	EMME-AS-80-S-HS-AS
■				■	■		■	2093138	EMME-AS-80-S-HS-ASB
■				■		■		2093137	EMME-AS-80-S-HS-AM
■				■		■	■	2093139	EMME-AS-80-S-HS-AMB
	■	■			■			2093168	EMME-AS-80-M-LS-AS
	■	■			■		■	2093170	EMME-AS-80-M-LS-ASB
	■	■				■		2093169	EMME-AS-80-M-LS-AM
	■	■				■	■	2093171	EMME-AS-80-M-LS-AMB
	■			■	■			2093200	EMME-AS-80-M-HS-AS
	■			■	■		■	2093202	EMME-AS-80-M-HS-ASB
	■			■		■		2093201	EMME-AS-80-M-HS-AM
	■			■		■	■	2093203	EMME-AS-80-M-HS-AMB
Flange size 100									
■				■	■			2103467	EMME-AS-100-S-HS-AS
■				■	■		■	2103469	EMME-AS-100-S-HS-ASB
■				■		■		2103468	EMME-AS-100-S-HS-AM
■				■		■	■	2103470	EMME-AS-100-S-HS-AMB
	■			■	■			2103499	EMME-AS-100-M-HS-AS
	■			■	■		■	2103501	EMME-AS-100-M-HS-ASB
	■			■		■		2103500	EMME-AS-100-M-HS-AM
	■			■		■	■	2103502	EMME-AS-100-M-HS-AMB

Servo motors EMME-AS

Accessories

Gear unit EMGA

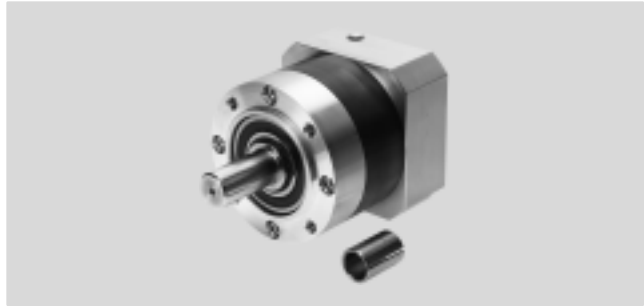

Technical data					
For motor flange size	40			60	
Gear unit type	EMGA-40-P-G...-40			EMGA-60-P-G...-60	
Gear ratio [i]	3	5	3	5	
Gear unit type	Planetary gear unit				
Continuous output torque ¹⁾ [Nm]	11	14	28	40	
Max. output torque ²⁾ [Nm]	17.6	22	45	64	
Max. drive speed [rpm]	18,000		13,000		
Torsional rigidity [Nm/arcmin]	1		2.3		
Torsional backlash [deg]	0.25		0.17		
Mass moment of inertia ³⁾ [kgcm ²]	0.031	0.019	0.135	0.078	
Max. efficiency [%]	98				
Operating temperature ⁴⁾ [°C]	-25 ... +90				
Protection class	IP54				
Product weight [g]	350			900	

For motor flange size	80		100			
Gear unit type	EMGA-80-P-G...-80		EMGA-80-P-G...-100		EMGA-120-P-G...-100	
Gear ratio [i]	3	5	3	5	3	5
Gear unit type	Planetary gear unit					
Continuous output torque ¹⁾ [Nm]	85	110	85	110	115	195
Max. output torque ²⁾ [Nm]	136	176	136	176	184	312
Max. drive speed [rpm]	7,000		7,000		6,500	
Torsional rigidity [Nm/arcmin]	6		6		12	
Torsional backlash [deg]	0.12		0.12		0.12	
Mass moment of inertia ³⁾ [kgcm ²]	0.77	0.45	0.77	0.45	2.63	1.53
Max. efficiency [%]	98		96		96	
Operating temperature ⁴⁾ [°C]	-25 ... +90					
Protection class	IP54					
Product weight [g]	2,000		2,100		6,000	

- 1) At the output shaft
- 2) The specifications refer to an output shaft speed of 100 rpm as well as operating mode S1 and a temperature of 30 °C
- 3) Referred to the drive shaft
- 4) Note the temperature range of the motor

Servo motors EMME-AS

Accessories

Dimensions

Download CAD data → www.festo.com

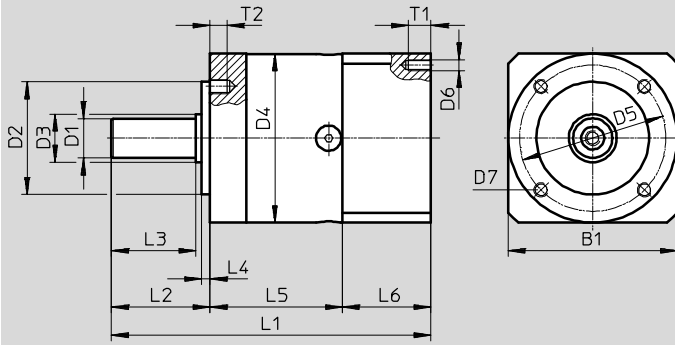

Type	B1	D1 ∅ h7	D2 ∅ h7	D3 ∅	D4 ∅	D5 ∅	D6	D7
EMGA-40-P-G...-40	40	10	26	12	40	34	M3	M4
EMGA-60-P-G...-60	60	14	40	17	60	52	M4	M5
EMGA-80-P-G...-80	80	20	60	25	80	70	M5	M6
EMGA-80-P-G...-100	100	20	60	25	80	70	M8	M6
EMGA-120-P-G...-100	115	25	80	35	115	100	M8	M10

Type	L1	L2	L3 ±0.2	L4 ±0.2	L5	L6	T1	T2
EMGA-40-P-G...-40	93.5	26	23	2	39	28.5	8	6
EMGA-60-P-G...-60	113.5	35	30	3	47	31	10	8
EMGA-80-P-G...-80	138.5	40	36	3	60	38.5	12	10
EMGA-80-P-G...-100	143.5	40	36	3	60	43.5	16	10
EMGA-120-P-G...-100	176.5	55	50	4	74	47.5	20	16

Ordering data

For motor flange size	Gear ratio	Part No.	Type
40	3	2297684	EMGA-40-P-G3-EAS-40
	5	2297685	EMGA-40-P-G5-EAS-40
60	3	2297686	EMGA-60-P-G3-EAS-60
	5	2297687	EMGA-60-P-G5-EAS-60
80	3	2297690	EMGA-80-P-G3-EAS-80
	5	2297691	EMGA-80-P-G5-EAS-80
100	3	552194	EMGA-80-P-G3-SAS-100
	5	552195	EMGA-80-P-G5-SAS-100
	3	552196	EMGA-120-P-G3-SAS-100
	5	552197	EMGA-120-P-G5-SAS-100

Servo motors EMME-AS

Accessories

Technical data – Cables		
Designation	Motor cable	
For motor	EMME-AS-40/60	EMME-AS-80/100
Type	NEBM-M16G8-...-Q7-...	NEBM-M16G8-...-Q9-...
Cable composition	2x (2x 0.25 mm ²) (3 A, 48 V, 0.5 KV)	2x (2x 0.5 mm ²) (8 A, 300 V, 2.5 KV)
	4x 0.75 mm ² (12 A, 600 V, 2.5 KV)	4 x 1.5 mm ² (16 A, 600 V, 2.5 KV)
	Screened	
Degree of contamination	3	
Min. bending radius [mm]	55	64
Ambient temperature [°C]	-50 ... +90	
Ambient temperature ¹⁾ [°C]	-40 ... +90	
Cable characteristics	Suitable for use with energy chains	
Protection class	IP65 (in assembled state)	
Material	Polyurethane	
Note on materials	RoHS-compliant	
CE marking (see declaration of conformity)	To EU Low Voltage Directive	

Designation	Encoder cable	
For motor	EMME-AS-40/60/80/100	
Type	NEBM-M12G8-...	
Cable composition	4x (2x 0.14 mm ²)	
	Screened	
Degree of contamination	3	
Min. bending radius [mm]	68	
Ambient temperature [°C]	-40 ... +80	
Ambient temperature ¹⁾ [°C]	-5 ... +80	
Cable characteristics	Suitable for use with energy chains	
Protection class	IP65 (in assembled state)	
Material	Polyurethane	
Note on materials	RoHS-compliant	

1) With flexible cable installation

Recommended cable cross section as a function of cable length l and max. motor current I_0

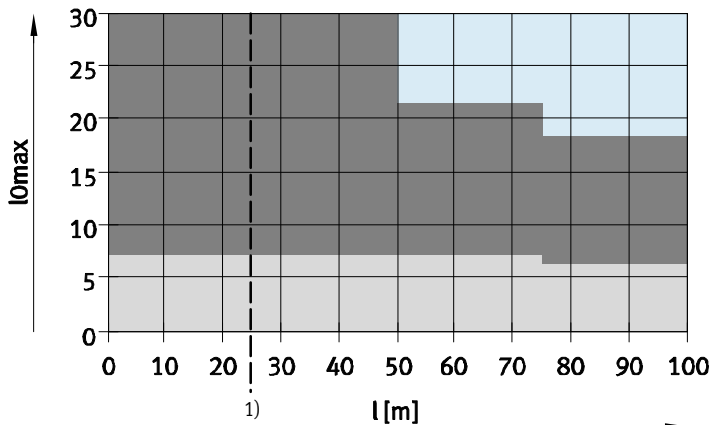

1) Cable lengths > 25 m possible following technical clarification; up to 100 m on request.

- No standard
- 1,5 mm²
- 0,75 mm²

Servo motors EMME-AS

Accessories

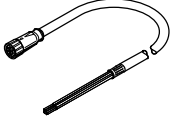
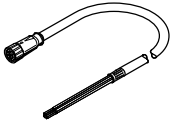
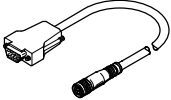
Ordering data			
	Cable length [m]	Part No.	Type
Motor cable			
	For EMME-AS-40/60 (cable cross section: 0.75 mm ²)		
	2.5	8004662	NEBM-M16G8-E-2.5-Q7-LE8
	5	8003770	NEBM-M16G8-E-5-Q7-LE8
	7.5	8004663	NEBM-M16G8-E-7.5-Q7-LE8
	10	8003771	NEBM-M16G8-E-10-Q7-LE8
	15	8003772	NEBM-M16G8-E-15-Q7-LE8
	X length ¹⁾	8003773	NEBM-M16G8-E--Q7-LE8
	For EMME-AS-80/100 (cable cross section: 1.5 mm ²)		
	2.5	8004660	NEBM-M16G8-E-2.5-Q9-LE8
	5	8003766	NEBM-M16G8-E-5-Q9-LE8
	7.5	8004661	NEBM-M16G8-E-7.5-Q9-LE8
	10	8003767	NEBM-M16G8-E-10-Q9-LE8
	15	8003768	NEBM-M16G8-E-15-Q9-LE8
	X length ¹⁾	8003769	NEBM-M16G8-E--Q9-LE8
Encoder cable			
	For EMME-AS-40/60/80/100		
	2.5	8004664	NEBM-M12G8-E-2.5-N-S1G15
	5	8003762	NEBM-M12G8-E-5-N-S1G15
	7.5	8004665	NEBM-M12G8-E-7.5-N-S1G15
	10	8003763	NEBM-M12G8-E-10-N-S1G15
	15	8003764	NEBM-M12G8-E-15-N-S1G15
	X length ¹⁾	8003765	NEBM-M12G8-E--N-S1G15

1) Max. 25 m. Cable lengths > 25 m possible following technical clarification; up to 100 m on request.
Available in 0.1 m increments.