

Standard cylinders DSBF-C, to ISO 15552, Clean Design



Standard cylinders DSBF-C, to ISO 15552, Clean Design

Key features

At a glance



DIN



- Standards-based cylinders to ISO 15552 (corresponds to the withdrawn standards ISO 6431, DIN ISO 6431, VDMA 24 562, NF E 49 003.1 and UNI 10290)

- The standard cylinder is used wherever hygiene, ease of cleaning and resistance are important, predominantly in dry and splash zones in the food and packaging industry
- For hygiene reasons, the threads on the end caps should be sealed with suitable blanking screws (available as accessories → 31)

- Resistant to conventional cleaning agents
- Increased corrosion protection
- Three types of cushioning available:
 - P cushioning: elastic cushioning rings/pads at both ends
 - PPS cushioning: pneumatic cushioning, self-adjusting at both ends
 - PPV cushioning: pneumatic cushioning, adjustable at both ends

- The variants can be configured according to individual needs thanks to the modular product system
- High flexibility thanks to the wide range of variants
- Comprehensive range of mounting accessories for just about every type of installation
- Contactless position sensing via proximity sensors

The technology in detail



- 1 Hygienic and self-adjusting PPS cushioning
- 2 Easy-to-clean cylinder profile without corners and indents
- 3 Corrosion-resistant cylinder surface
- 4 Standard dimensions and mounting accessories to ISO 15552

- 5 NSF-H1 lubricant and special wiper seal suitable for contact with food (feature A3). Long service life even with no or insufficient lubrication due to frequent cleaning.

Longer service life with protective bellows kit DADB

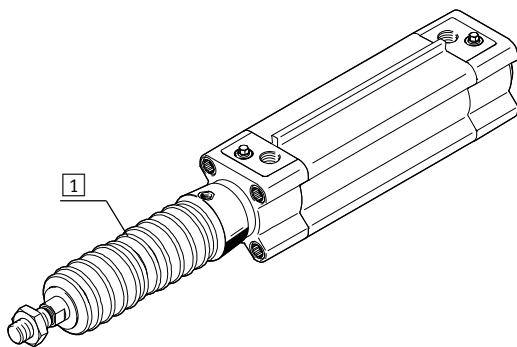









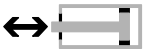
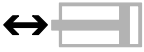

The protective bellows kit is a leak-free system. To prevent unwanted media from being drawn in, the supply and exhaust air must be ducted via a pressure compensation hole in the connection part **1**. The kit protects the piston rod, seal

and bearings against a wide variety of media, for example:

- Dust
- Chippings
- Oil
- Grease
- Fuel

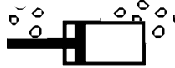
Standard cylinders DSBF-C, to ISO 15552, Clean Design

Key features

Variants from the modular product system		
Symbol	Features	Description
	L Low friction	Much higher efficiency than other versions at high piston speeds. The special materials considerably reduce system wear. This enables low-friction movement, especially during fast stroke movements. Seal contains silicone grease
	U Uniform, slow movement	Low break-away pressure, suitable for slow stroke movements at a constant, stick-slip-free velocity curve over the full stroke range. Seal contains silicone grease
	T Through piston rod	For working at both ends with the same force in the forward and return stroke, for attaching external stops
	F Female piston rod thread	–
	T1 Heat-resistant seals	Temperature range 0 ... +120 °C The seals and grease in this variant are not FDA-compliant.
	T3 Low temperature	Temperature range –40 ... +80 °C The seals and grease in this variant are not FDA-compliant.
	T4 Heat-resistant seals	Temperature range 0 ... +150 °C
	A1 Scraper variant	Increased chemical resistance: For a longer lifetime, e.g. when using cooling lubricants.
	A2 Scraper variant	Hard scraper: The cylinder is equipped with a hard-chrome plated piston rod and a hard scraper, which protects against dry, dusty media
	A3 Scraper variant	Unlubricated operation: Cleaning processes degrease the piston rod. A special piston rod seal designed for unlubricated operation permits a longer service life compared to the standard seal
	...E Piston rod extension	–
	...L Piston rod thread extension	–

Standard cylinders DSBF-C, to ISO 15552, Clean Design

Product range overview

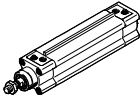
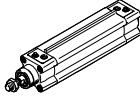
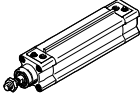
Function	Design	Type	Piston Ø	Stroke	Through piston rod	Female piston rod thread	Cushioning		
			[mm]	[mm]					
Double-acting	DSBF-...								
		DSBF-...	32, 40, 50, 63, 80, 100, 125	1 ... 2800	■	■	■	■	■
	DSBF-...-L, low friction								
		DSBF-...-L	32, 40, 50, 63, 80, 100	1 ... 2800	-	■	■	■	■
DSBF-...-U, uniform, slow movement									
	DSBF-...-U	32, 40, 50, 63, 80, 100, 125	1 ... 2800	-	■	■	■	■	

Standard cylinders DSBF-C, to ISO 15552, Clean Design

Product range overview

Type	Position sensing	Temperature range 0 ... +120 °C	Temperature range -40 ... +80 °C	Temperature range 0 ... +150 °C	Scraper variant Increased chemical resistance	Scraper variant Hard scraper	Scraper variant For unlubricated operation	EU certification	Piston rod extension	Piston rod thread extension	Sensor mounting
	A	T1	T3	T4	A1	A2	A3	EX4	...E	...L	R
DSBF-...											
DSBF-...	■	■	■	■	■	■	■	■	■	■	■
DSBF-...-L, low friction											
DSBF-...-L	■	-	-	-	-	-	-	-	■	■	■
DSBF-...-U, uniform, slow movement											
DSBF-...-U	■	-	-	-	-	-	-	-	■	■	■

Standard cylinders DSBF-C, to ISO 1552, Clean Design

Peripherals overview

FESTO

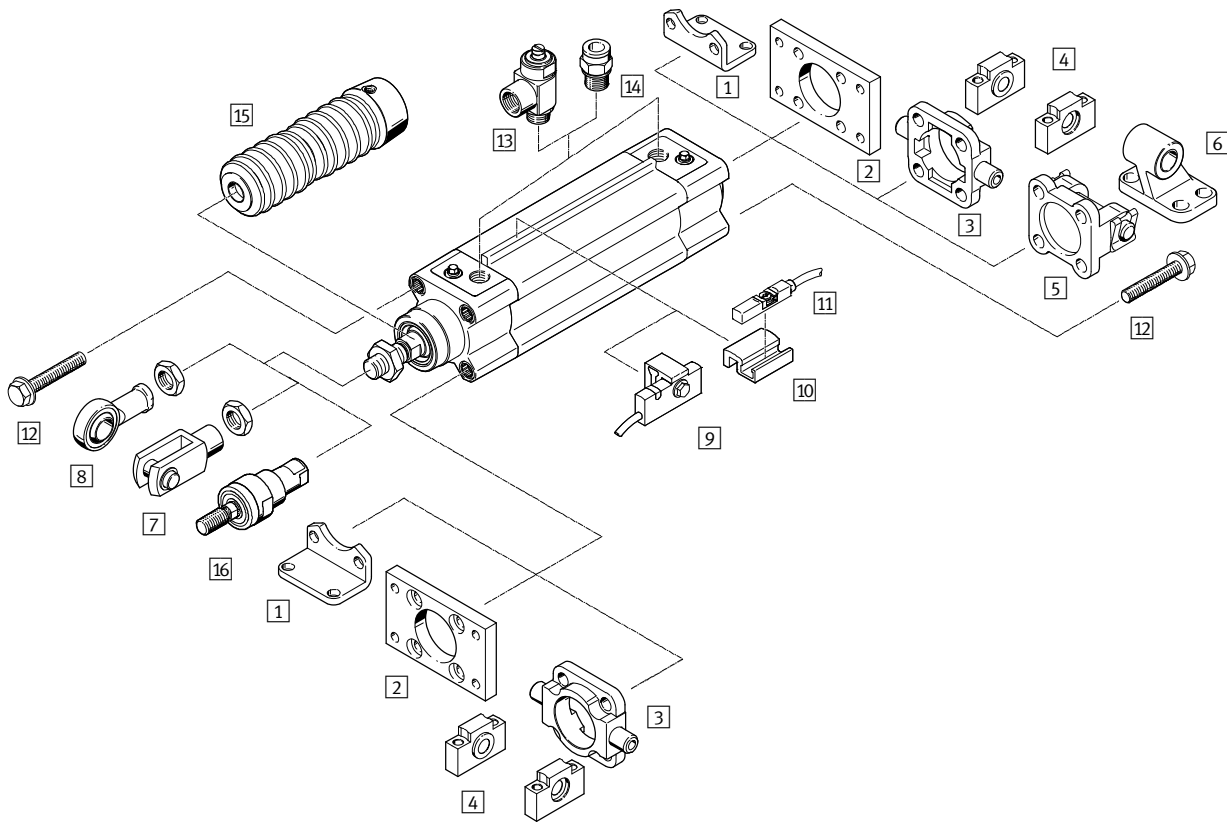

Standard cylinders DSBF-C, to ISO 15552, Clean Design

Peripherals overview

Mounting components and accessories		
	Description	→ Page/Internet
1	Foot mounting CRHNC	For bearing and end caps 22
2	Flange mounting CRFNG	– For bearing or end caps – Cannot be used on the bearing cap in combination with protective bellows kit DADB 22
3	Trunnion flange CRZNG	– For bearing or end caps in combination with trunnion supports CRLNZG – Cannot be used on the bearing cap in combination with protective bellows kit DADB 23
4	Trunnion support CRLNZG	For swivel mounting CRZNG 23
5	Swivel flange SNCB- ... -R3	For end caps 24
6	Clevis foot CRLNG	For swivel flange SNCB- ... -R3 24
7	Rod clevis CRSG	Permits a swivelling movement of the cylinder in one plane 24
8	Rod eye CRSGS	With spherical bearing 24
9	Proximity sensor SMT-C1	<ul style="list-style-type: none"> • For sensing the piston rod position • Proximity sensor is mounted on the sensor mounting rail 29
10	Mounting kit SMB-8-C	<ul style="list-style-type: none"> • For mounting the proximity sensor CRSMT-8M • Mounting kit is mounted on the sensor mounting rail 29
11	Proximity sensor CRSMT-8M	For sensing the piston rod position 29
12	Blanking screw DAMD	For covering unused mounting threads 31
13	One-way flow control valve CRGRLA	For regulating speed 31
14	Push-in fitting NPQH/CRQS/CRQSL	For connecting compressed air tubing with standard O.D. 30
15	Protective bellows kit DADB	– Protects the cylinder (piston rod, seal and bearings) against a wide range of media and thus prevents premature wear – The kit can only be used in combination with a piston rod extension (feature: ...E) 25
16	Self-aligning rod coupler CRFK	For compensating radial and angular misalignments 24

Standard cylinders DSBF-C, to ISO 15552, Clean Design

Type codes

		DSBF	-	C	-		-	32	-	300	-		-		-	PPV	-	A	-	N3	
Type																					
Standard cylinder, Clean Design																					
Version																					
C	Easy-to-clean design																				
Running characteristics																					
-	Standard																				
L	Low friction																				
M	Uniform, slow movement																				
Piston Ø [mm]																					
Stroke [mm]																					
Piston rod																					
-	At one end																				
T	Through piston rod																				
Piston rod thread type																					
-	Male thread																				
F	Female thread																				
Cushioning																					
P	Elastic cushioning rings/pads at both ends																				
PPS	Pneumatic cushioning, self-adjusting at both ends																				
PPV	Pneumatic cushioning, adjustable at both ends																				
Position sensing																					
A	Via proximity sensor																				
Standard																					
-	Based on ISO 15552																				
N3	Corresponds to ISO 15552																				

Standard cylinders DSBF-C, to ISO 15552, Clean Design

Type codes

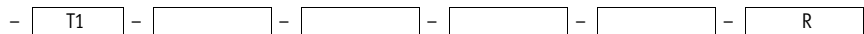

Temperature range

-	Standard
T1	0 ... +120 °C
T3	-40 ... +80 °C
T4	0 ... +150 °C

Scraper variant

-	None
A1	Increased chemical resistance
A2	Hard scraper
A3	For unlubricated operation

EU certification

-	None
EX4	II 2GD

Piston rod extension

... E	1 ... 500 mm
-------	--------------

Piston rod thread extension

... L	1 ... 70 mm
-------	-------------

Sensor mounting

R	Mounting rail for sensors
---	---------------------------

Standard cylinders DSBF-C, to ISO 15552, Clean Design

FESTO

Technical data

Function
P cushioning

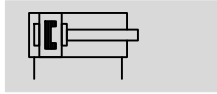

PPS cushioning

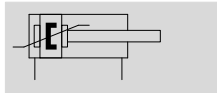

PPV cushioning

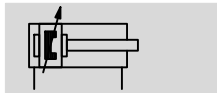

DIN



- Ø - Diameter
32 ... 125 mm

- | - Stroke length
1 ... 2800 mm

- T - www.festo.com



General technical data								
Piston Ø		32	40	50	63	80	100	125
Pneumatic connection		G $\frac{1}{8}$	G $\frac{1}{4}$	G $\frac{1}{4}$	G $\frac{3}{8}$	G $\frac{3}{8}$	G $\frac{1}{2}$	G $\frac{1}{2}$
Piston rod thread		M10x1.25	M12x1.25	M16x1.5	M16x1.5	M20x1.5	M20x1.5	M27x2
Stroke								
DSBF-...	[mm]	1 ... 2800						
DSBF-...-...E	[mm]	1 ... 2000						
DSBF-...-...L	[mm]	1 ... 2000						
Design		Piston						
		Piston rod						
		Profile barrel						
Mode of operation		Double-acting						
Cushioning								
DSBF-...-P		Elastic cushioning rings/pads at both ends						
DSBF-...-PPS		Pneumatic cushioning, self-adjusting at both ends						
DSBF-...-PPV		Pneumatic cushioning, adjustable at both ends						
Cushioning length								
DSBF-...-PPV	[mm]	17	19	22	22	31	31	45
Position sensing		Via proximity sensor						
Type of mounting		Via female thread						
		Via accessories						
Mounting position		Any						

Standard cylinders DSBF-C, to ISO 15552, Clean Design

Technical data

Operating and environmental conditions								
Piston Ø		32	40	50	63	80	100	125
Operating medium	Compressed air to ISO 8573-1:2010 [7:4:4]							
Note on operating/pilot medium	Lubricated operation possible (in which case lubricated operation will always be required)							
Operating pressure								
DSBF-...	[bar]	0.6 ... 12		0.4 ... 12			0.2 ... 10	
DSBF-...-L/-U ¹⁾	[bar]	0.25 ... 12		0.2 ... 12	0.15 ... 12	0.1 ... 12		
DSBF-...-T3/-A2	[bar]	1 ... 12					1 ... 10	
DSBF-...-A3	[bar]	1.5 ... 12		1 ... 12	0.6 ... 12		0.6 ... 10	
Ambient temperature ²⁾								
DSBF-...	[°C]	-20 ... +80						
DSBF-...-L/-A1	[°C]	0 ... +80						
DSBF-...-T1	[°C]	0 ... +120						
DSBF-...-T3	[°C]	-40 ... +80						
DSBF-...-T4	[°C]	0 ... +150						
DSBF-...-EX4	[°C]	-20 ... +60						
Suitable for use in the food industry ³⁾	As per manufacturer's declaration							
Corrosion resistance class CRC ⁴⁾	3							

- 1) Values only applicable for strokes ≤ 500 mm
In combination with cushioning PPS/PPV, the specifications only apply outside the cushioning range
- 2) Note operating range of proximity sensors
- 3) Additional information www.festo.com/sp → User documentation.
- 4) Corrosion resistance class CRC 3 to Festo standard FN 940070
High corrosion stress. Outdoor exposure under moderate corrosive conditions. External visible parts with primarily functional requirements for the surface and which are in direct contact with a normal industrial environment.

ATEX ¹⁾	
Explosion-proof ambient temperature	-20°C ≤ Ta ≤ +60°C
CE marking (see declaration of conformity)	To EU Explosion Protection Directive (ATEX)
ATEX category for gas	II 2G
Explosion ignition protection type for gas	cT4
ATEX category for dust	II 2D
Explosion ignition protection type for dust	cT120°C

- 1) Note the ATEX certification of the accessories.

Forces [N] and impact energy [J]								
Piston Ø		32	40	50	63	80	100	125
Theoretical force at 6 bar, advancing		483	754	1178	1870	3016	4712	7363
Theoretical force at 6 bar, retracting		415	633	990	1682	2721	4418	6881
Max. impact energy in the end positions								
DSBF-...		0.4	0.7	1.0	1.3	1.8	2.5	3.3
DSBF-...-L/-U/-T1/-T3/-T4		0.2	0.35	0.5	0.65	0.9	1.25	1.65

Permissible impact velocity:

$$v_{perm.} = \sqrt{\frac{2 \times E_{perm.}}{m_{intrinsic} + m_{Load}}}$$

Maximum permissible load:

$$m_{Load} = \frac{2 \times E_{perm.}}{v^2} - m_{intrinsic}$$

$v_{perm.}$ Permissible impact velocity
 $E_{perm.}$ Maximum impact energy
 $m_{intrinsic}$ Moving mass (drive)
 m_{Load} Moving payload

Standard cylinders DSBF-C, to ISO 15552, Clean Design



Technical data

Weight [g]							
Piston Ø	32	40	50	63	80	100	125
DSBF-...							
Product weight with 0 mm stroke	472	778	1241	1803	3131	4551	6928
Additional weight per 10 mm stroke	28	40	58	65	95	106	163
Moving mass with 0 mm stroke	108	204	363	460	800	1045	2245
Moving mass per 10 mm stroke	9	16	25	25	39	39	63
DSBF-...-T							
Product weight with 0 mm stroke	588	962	1574	2166	3714	5239	7767
Additional weight per 10 mm stroke	35	53	83	89	136	146	226
Moving mass with 0 mm stroke	179	338	611	714	1282	1561	3084
Moving mass per 10 mm stroke	18	32	50	50	78	78	126

Materials

Sectional view

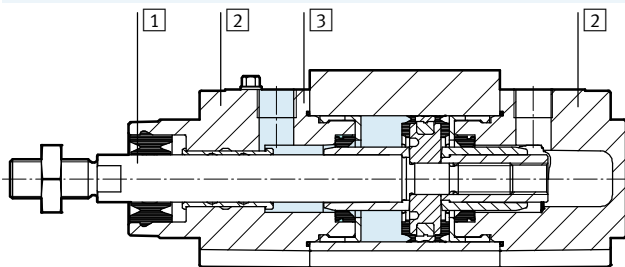

Standard cylinder	
1	Piston rod High-alloy stainless steel
2	Cover Die-cast aluminium, coated
3	Cylinder barrel Anodised wrought aluminium alloy
-	Piston rod seal
	DSBF-... TPE-U (PUR) media sealing (modified for resistance to hydrolysis and cleaning agents)
	DSBF-...-L/-U/T1/-T4/-A1 FPM
	DSBF-...-T3 TPE-U (PUR) (suitable for low temperatures)
	DSBF-...-A3 UHMW-PE
	Cushioning seal
	DSBF-... TPE-U (PUR)
	DSBF-...-U/-T1/-T4/-A1 FPM
	DSBF-...-T3 TPE-U (PUR) (suitable for low temperatures)
	Cushioning boss
	DSBF-... POM
	DSBF-...-T1/-T3/-T4 Aluminium
	Note on materials
	DSBF-... RoHS-compliant
	DSBF-...-L/-U/-T1/-T3/-T4/-A1/-A3 Contains PWIS (paint-wetting impairment substances)

Standard cylinders DSBF-C, to ISO 1552, Clean Design

Technical data

Max. lateral force F_q as a function of stroke length l

Horizontal mounting

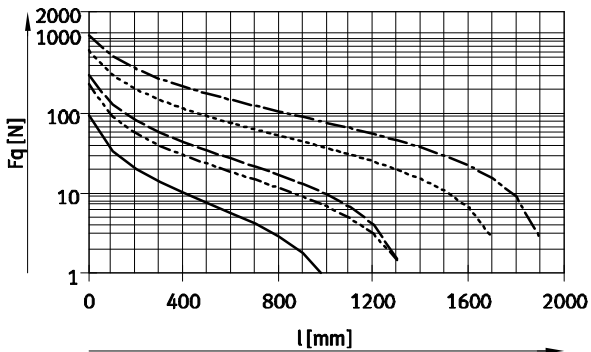

——— \varnothing 32 - - - - - \varnothing 80/100
 - - - - - \varnothing 40 - - - - - \varnothing 125
 - - - - - \varnothing 50/63

Vertical mounting

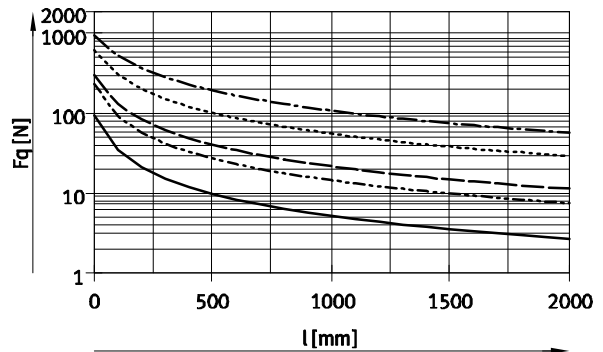

——— \varnothing 32 - - - - - \varnothing 80/100
 - - - - - \varnothing 40 - - - - - \varnothing 125
 - - - - - \varnothing 50/63

End-position sensing

A minimum stroke is required to be able to sense both end positions at the cylinder.

1 Position of the proximity sensor within the housing.

With proximity sensor SMT-C1

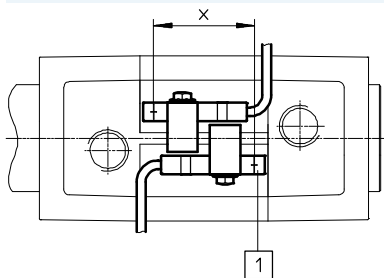

Piston \varnothing	32	40	50	63 ... 125
Minimum stroke x [mm]	18	17	13	10

With mounting kit SMB-8-C and proximity sensor CRSMT-8M

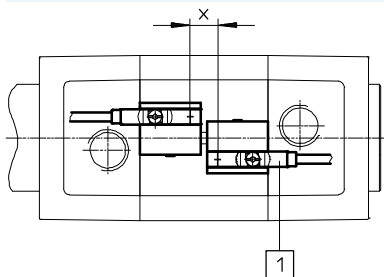

Piston \varnothing	32 ... 125
Minimum stroke x [mm]	10

Standard cylinders DSBF-C, to ISO 15552, Clean Design

Technical data

FESTO

Dimensions

Download CAD data → www.festo.com

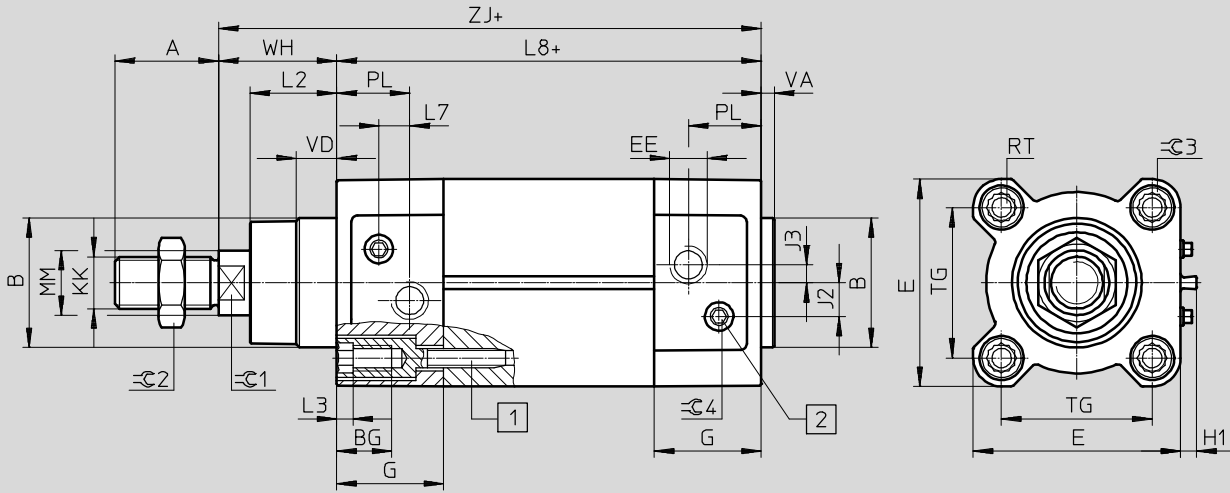

Ø 80 ... 125

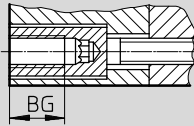

Ø 125

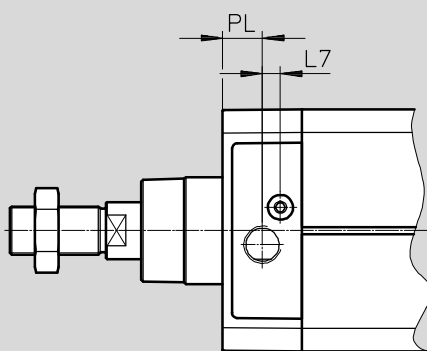

+ = plus stroke length

- 1 Socket head screw with female thread for mounting components
- 2 Regulating screw for adjustable end-position cushioning

Standard cylinders DSBF-C, to ISO 15552, Clean Design

Technical data

∅ [mm]	A -0.5	B ∅ d11	BG min.	E +0.5	EE	G -0.2	H1 ±0.2	J2 ±0.1	J3 ±0.1
32	22	30	16	45	G1/8	28	5	5.7	5.3
40	24	35	16	54	G1/4	33	5	8	4
50	32	40	16	64	G1/4	33	5	10.4	5.5
63	32	45	16	75	G3/8	40.5	5	12.75	6.3
80	40	45	17	93	G3/8	43	5	12.5	8
100	40	55	17	110	G1/2	48	5	13.5	10
125	54	60	20	136	G1/2	44.7	5	13	8

∅ [mm]	KK	L2	L3 max.	L7	L8 ±0.4	MM ∅	PM ±0.1	RT	TG ±0.3
32	M10x1.25	18 _{-0.2}	5	6.5	94	12	19.5	M6	32.5
40	M12x1.25	21.3 _{-0.2}	5	7.5	105	16	22.5	M6	38
50	M16x1.5	26.8 _{-0.2}	5	9.5	106	20	22.5	M8	46.5
63	M16x1.5	27 _{-0.2}	5	9	121	20	27.5	M8	56.5
80	M20x1.5	34.2 _{-0.2}	-	11	128	25	30	M10	72
100	M20x1.5	38 _{-0.2}	-	7.5	138	25	31.5	M10	89
125	M27x2	45.5 _{-0.3}	-	10	160	32	22.5	M12	110

∅ [mm]	VA	VD +0.5	WH +2.2	ZJ +1.8	≈C1	≈C2	≈C3	≈C4
32	4 _{-0.2}	10	25	119.1	10	16	6	4
40	4 _{-0.2}	10.5	28.7	133.9	13	18	6	4
50	4 _{-0.2}	11.5	35.6	141.8	17	24	8	4
63	4 _{-0.2}	15	35.9	157.1	17	24	8	4
80	4 _{-0.2}	15.7	45.4	173.6	22	30	6	4
100	4 _{-0.2}	19.2	49.3	187.5	22	30	6	5
125	6 _{-0.3}	20.5	64.1	225	27	41	8	5

Standard cylinders DSBF-C, to ISO 1552, Clean Design

Technical data

FESTO

Dimensions – Variants

Download CAD data → www.festo.com

T – Through piston rod

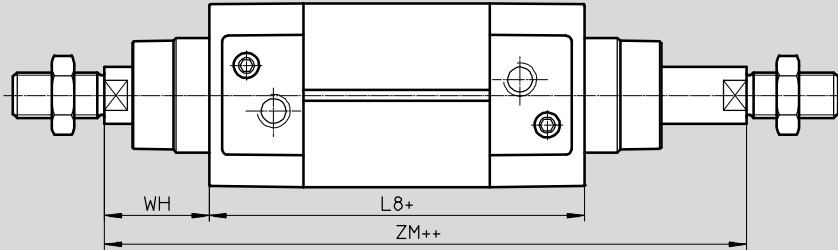

+ = plus stroke length
++ = plus 2x stroke length

F – Piston rod with female thread

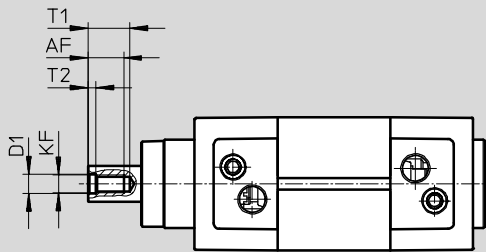

-  - Note
In combination with variant T, the piston rod has female threads at both ends.

...E – Piston rod extension

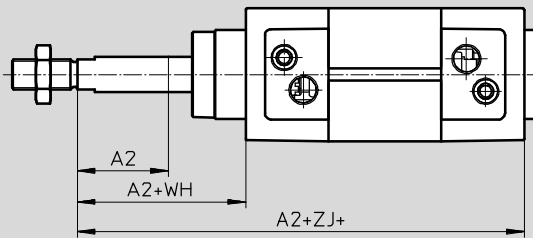

-  - Note
Piston rod extension at one end in combination with the variant T.

+ = plus stroke length

...L – Piston rod thread extension

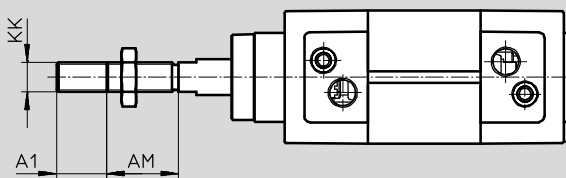

-  - Note
In combination with variant T, the piston rod thread is extended at both ends.

Standard cylinders DSBF-C, to ISO 15552, Clean Design

FESTO

Technical data

∅ [mm]	A1 max.	A2 max.	AM -0.5	AF	D1	KF
32	35	500	22	12	6.4 ^{+0,2}	M6
40			24	12	8.4 ^{+0,2}	M8
50	70		32	16	10.5 ^{+0,2}	M10
63			32	16	10.5 ^{+0,2}	M10
80			40	20	13 ^{+0,1}	M12
100			40	20	13 ^{+0,1}	M12
125			54	32	17 ^{+0,1}	M16

∅ [mm]	KK	L8 ±0.4	T1	T2 +0.2	WH +2.2	ZJ +1.8	ZM +1
32	M10x1.25	94	16	2.6	26	119.1	146.1
40	M12x1.25	105	16	3.3	28.7	133.9	164.8
50	M16x1.5	106	21	4.7	35.6	141.8	179.8
63	M16x1.5	121	21	4.7	35.9	157.1	195.4
80	M20x1.5	128	26.5	6.1	45.4	173.6	221
100	M20x1.5	138	26.5	6.1	49.3	187.5	238.8
125	M27x2	160	40	8	65	225	290

Standard cylinders DSBF-C, to ISO 15552, Clean Design

FESTO

Technical data

Ordering data					
Piston \varnothing [mm]	Stroke [mm]	PPS – Pneumatic cushioning, self-adjusting at both ends A – With position sensing		PPV – Pneumatic cushioning, adjustable at both ends A – With position sensing	
		Part No.	Type	Part No.	Type
Basic design					
32	25	1778834	DSBF-C-32-25-PPSA-N3-R	1773752	DSBF-C-32-25-PPVA-N3-R
	40	1778835	DSBF-C-32-40-PPSA-N3-R	1773753	DSBF-C-32-40-PPVA-N3-R
	50	1778836	DSBF-C-32-50-PPSA-N3-R	1773754	DSBF-C-32-50-PPVA-N3-R
	80	1778837	DSBF-C-32-80-PPSA-N3-R	1773755	DSBF-C-32-80-PPVA-N3-R
	100	1778838	DSBF-C-32-100-PPSA-N3-R	1773756	DSBF-C-32-100-PPVA-N3-R
	125	1778839	DSBF-C-32-125-PPSA-N3-R	1773757	DSBF-C-32-125-PPVA-N3-R
	160	1778840	DSBF-C-32-160-PPSA-N3-R	1773758	DSBF-C-32-160-PPVA-N3-R
	200	1778841	DSBF-C-32-200-PPSA-N3-R	1773759	DSBF-C-32-200-PPVA-N3-R
	250	1778842	DSBF-C-32-250-PPSA-N3-R	1773760	DSBF-C-32-250-PPVA-N3-R
	320	1778843	DSBF-C-32-320-PPSA-N3-R	1773761	DSBF-C-32-320-PPVA-N3-R
	400	1778844	DSBF-C-32-400-PPSA-N3-R	1773762	DSBF-C-32-400-PPVA-N3-R
	500	1778845	DSBF-C-32-500-PPSA-N3-R	1773763	DSBF-C-32-500-PPVA-N3-R
40	25	1779431	DSBF-C-40-25-PPSA-N3-R	1774259	DSBF-C-40-25-PPVA-N3-R
	40	1779432	DSBF-C-40-40-PPSA-N3-R	1774260	DSBF-C-40-40-PPVA-N3-R
	50	1779433	DSBF-C-40-50-PPSA-N3-R	1774261	DSBF-C-40-50-PPVA-N3-R
	80	1779434	DSBF-C-40-80-PPSA-N3-R	1774262	DSBF-C-40-80-PPVA-N3-R
	100	1779435	DSBF-C-40-100-PPSA-N3-R	1774263	DSBF-C-40-100-PPVA-N3-R
	125	1779436	DSBF-C-40-125-PPSA-N3-R	1774264	DSBF-C-40-125-PPVA-N3-R
	160	1779437	DSBF-C-40-160-PPSA-N3-R	1774265	DSBF-C-40-160-PPVA-N3-R
	200	1779438	DSBF-C-40-200-PPSA-N3-R	1774266	DSBF-C-40-200-PPVA-N3-R
	250	1779439	DSBF-C-40-250-PPSA-N3-R	1774267	DSBF-C-40-250-PPVA-N3-R
	320	1779440	DSBF-C-40-320-PPSA-N3-R	1774268	DSBF-C-40-320-PPVA-N3-R
	400	1779441	DSBF-C-40-400-PPSA-N3-R	1774269	DSBF-C-40-400-PPVA-N3-R
	500	1779442	DSBF-C-40-500-PPSA-N3-R	1774270	DSBF-C-40-500-PPVA-N3-R
50	25	1780283	DSBF-C-50-25-PPSA-N3-R	1775258	DSBF-C-50-25-PPVA-N3-R
	40	1780284	DSBF-C-50-40-PPSA-N3-R	1775259	DSBF-C-50-40-PPVA-N3-R
	50	1780285	DSBF-C-50-50-PPSA-N3-R	1775260	DSBF-C-50-50-PPVA-N3-R
	80	1780286	DSBF-C-50-80-PPSA-N3-R	1775261	DSBF-C-50-80-PPVA-N3-R
	100	1780287	DSBF-C-50-100-PPSA-N3-R	1775262	DSBF-C-50-100-PPVA-N3-R
	125	1780288	DSBF-C-50-125-PPSA-N3-R	1775263	DSBF-C-50-125-PPVA-N3-R
	160	1780289	DSBF-C-50-160-PPSA-N3-R	1775264	DSBF-C-50-160-PPVA-N3-R
	200	1780290	DSBF-C-50-200-PPSA-N3-R	1775265	DSBF-C-50-200-PPVA-N3-R
	250	1780291	DSBF-C-50-250-PPSA-N3-R	1775266	DSBF-C-50-250-PPVA-N3-R
	320	1780292	DSBF-C-50-320-PPSA-N3-R	1775267	DSBF-C-50-320-PPVA-N3-R
	400	1780293	DSBF-C-50-400-PPSA-N3-R	1775268	DSBF-C-50-400-PPVA-N3-R
	500	1780294	DSBF-C-50-500-PPSA-N3-R	1775269	DSBF-C-50-500-PPVA-N3-R
63	25	1780905	DSBF-C-63-25-PPSA-N3-R	1776043	DSBF-C-63-25-PPVA-N3-R
	40	1780906	DSBF-C-63-40-PPSA-N3-R	1776044	DSBF-C-63-40-PPVA-N3-R
	50	1780907	DSBF-C-63-50-PPSA-N3-R	1776045	DSBF-C-63-50-PPVA-N3-R
	80	1780908	DSBF-C-63-80-PPSA-N3-R	1776046	DSBF-C-63-80-PPVA-N3-R
	100	1780909	DSBF-C-63-100-PPSA-N3-R	1776047	DSBF-C-63-100-PPVA-N3-R
	125	1780910	DSBF-C-63-125-PPSA-N3-R	1776048	DSBF-C-63-125-PPVA-N3-R
	160	1780911	DSBF-C-63-160-PPSA-N3-R	1776049	DSBF-C-63-160-PPVA-N3-R
	200	1780912	DSBF-C-63-200-PPSA-N3-R	1776050	DSBF-C-63-200-PPVA-N3-R
	250	1780913	DSBF-C-63-250-PPSA-N3-R	1776051	DSBF-C-63-250-PPVA-N3-R
	320	1780914	DSBF-C-63-320-PPSA-N3-R	1776052	DSBF-C-63-320-PPVA-N3-R
	400	1780915	DSBF-C-63-400-PPSA-N3-R	1776053	DSBF-C-63-400-PPVA-N3-R
	500	1780916	DSBF-C-63-500-PPSA-N3-R	1776054	DSBF-C-63-500-PPVA-N3-R

Standard cylinders DSBF-C, to ISO 15552, Clean Design

Technical data

Ordering data					
Piston \varnothing [mm]	Stroke [mm]	PPS – Pneumatic cushioning, self-adjusting at both ends A – With position sensing		PPV – Pneumatic cushioning, adjustable at both ends A – With position sensing	
		Part No.	Type	Part No.	Type
Basic design					
80	25	1781061	DSBF-C-80-25-PPSA-N3-R	1778429	DSBF-C-80-25-PPVA-N3-R
	40	1781062	DSBF-C-80-40-PPSA-N3-R	1778430	DSBF-C-80-40-PPVA-N3-R
	50	1781063	DSBF-C-80-50-PPSA-N3-R	1778431	DSBF-C-80-50-PPVA-N3-R
	80	1781064	DSBF-C-80-80-PPSA-N3-R	1778432	DSBF-C-80-80-PPVA-N3-R
	100	1781065	DSBF-C-80-100-PPSA-N3-R	1778433	DSBF-C-80-100-PPVA-N3-R
	125	1781066	DSBF-C-80-125-PPSA-N3-R	1778434	DSBF-C-80-125-PPVA-N3-R
	160	1781067	DSBF-C-80-160-PPSA-N3-R	1778435	DSBF-C-80-160-PPVA-N3-R
	200	1781068	DSBF-C-80-200-PPSA-N3-R	1778436	DSBF-C-80-200-PPVA-N3-R
	250	1781069	DSBF-C-80-250-PPSA-N3-R	1778437	DSBF-C-80-250-PPVA-N3-R
	320	1781070	DSBF-C-80-320-PPSA-N3-R	1778438	DSBF-C-80-320-PPVA-N3-R
	400	1781071	DSBF-C-80-400-PPSA-N3-R	1778439	DSBF-C-80-400-PPVA-N3-R
	500	1781072	DSBF-C-80-500-PPSA-N3-R	1778440	DSBF-C-80-500-PPVA-N3-R
	100	25	1782823	DSBF-C-100-25-PPSA-N3-R	1782253
40		1782824	DSBF-C-100-40-PPSA-N3-R	1782254	DSBF-C-100-40-PPVA-N3-R
50		1782825	DSBF-C-100-50-PPSA-N3-R	1782255	DSBF-C-100-50-PPVA-N3-R
80		1782826	DSBF-C-100-80-PPSA-N3-R	1782256	DSBF-C-100-80-PPVA-N3-R
100		1782827	DSBF-C-100-100-PPSA-N3-R	1782257	DSBF-C-100-100-PPVA-N3-R
125		1782828	DSBF-C-100-125-PPSA-N3-R	1782258	DSBF-C-100-125-PPVA-N3-R
160		1782829	DSBF-C-100-160-PPSA-N3-R	1782259	DSBF-C-100-160-PPVA-N3-R
200		1782830	DSBF-C-100-200-PPSA-N3-R	1782260	DSBF-C-100-200-PPVA-N3-R
250		1782831	DSBF-C-100-250-PPSA-N3-R	1782261	DSBF-C-100-250-PPVA-N3-R
320		1782832	DSBF-C-100-320-PPSA-N3-R	1782262	DSBF-C-100-320-PPVA-N3-R
400		1782833	DSBF-C-100-400-PPSA-N3-R	1782263	DSBF-C-100-400-PPVA-N3-R
500		1782834	DSBF-C-100-500-PPSA-N3-R	1782264	DSBF-C-100-500-PPVA-N3-R
125		25	1792953	DSBF-C-125-25-PPSA-N3-R	1785012
	40	1792954	DSBF-C-125-40-PPSA-N3-R	1785013	DSBF-C-125-40-PPVA-N3-R
	50	1792955	DSBF-C-125-50-PPSA-N3-R	1785014	DSBF-C-125-50-PPVA-N3-R
	80	1792956	DSBF-C-125-80-PPSA-N3-R	1785015	DSBF-C-125-80-PPVA-N3-R
	100	1792957	DSBF-C-125-100-PPSA-N3-R	1785016	DSBF-C-125-100-PPVA-N3-R
	125	1792958	DSBF-C-125-125-PPSA-N3-R	1785017	DSBF-C-125-125-PPVA-N3-R
	160	1792959	DSBF-C-125-160-PPSA-N3-R	1785018	DSBF-C-125-160-PPVA-N3-R
	200	1792960	DSBF-C-125-200-PPSA-N3-R	1785019	DSBF-C-125-200-PPVA-N3-R
	250	1792961	DSBF-C-125-250-PPSA-N3-R	1785020	DSBF-C-125-250-PPVA-N3-R
	320	1792962	DSBF-C-125-320-PPSA-N3-R	1785021	DSBF-C-125-320-PPVA-N3-R
	400	1792963	DSBF-C-125-400-PPSA-N3-R	1785022	DSBF-C-125-400-PPVA-N3-R
	500	1792964	DSBF-C-125-500-PPSA-N3-R	1785023	DSBF-C-125-500-PPVA-N3-R

 Note
Other variants in the modular product system → 21

Standard cylinders DSBF-C, to ISO 15552, Clean Design

Technical data

Ordering data					
Piston \varnothing [mm]	Stroke [mm]	PPS – Pneumatic cushioning, self-adjusting at both ends A – With position sensing		PPV – Pneumatic cushioning, adjustable at both ends A – With position sensing	
		Part No.	Type	Part No.	Type
Variable stroke					
32	1 ... 2800	1778516	DSBF-C-32-...-PPSA-N3-R	1772262	DSBF-C-32-...-PPVA-N3-R
40	1 ... 2800	1779309	DSBF-C-40-...-PPSA-N3-R	1774182	DSBF-C-40-...-PPVA-N3-R
50	1 ... 2800	1779742	DSBF-C-50-...-PPSA-N3-R	1774418	DSBF-C-50-...-PPVA-N3-R
63	1 ... 2800	1780600	DSBF-C-63-...-PPSA-N3-R	1775324	DSBF-C-63-...-PPVA-N3-R
80	1 ... 2800	1780945	DSBF-C-80-...-PPSA-N3-R	1778184	DSBF-C-80-...-PPVA-N3-R
100	1 ... 2800	1781567	DSBF-C-100-...-PPSA-N3-R	1781598	DSBF-C-100-...-PPVA-N3-R
125	1 ... 2800	1792703	DSBF-C-125-...-PPSA-N3-R	1784637	DSBF-C-125-...-PPVA-N3-R

 - Note
Other variants in the modular product system → 21

Standard cylinders DSBF-C, to ISO 15552, Clean Design

Ordering data – Modular products

Ordering table											
Size	32	40	50	63	80	100	125	Condi- tions	Code	Entry code	
M Module No.	570077	570078	570079	570080	570081	570082	1755169				
Function	Clean Design standard cylinder								DSBF	DSBF	
Product version	Easy-to-clean design								-C	-C	
O Running characteristics	Standard										
	Low friction							-	1	L	
	Constant, slow movement								1	M	
M Piston diameter [mm]	32	40	50	63	80	100	125		-...		
Stroke [mm]	1 ... 2800									-...	
O Piston rod	At one end										
	Through piston rod									-T	
Piston rod thread type	Male thread										
	Female thread							2	F		
M Cushioning	Elastic cushioning rings/plates at both ends									-P	
	Pneumatic cushioning, self-adjusting at both ends							3		-PPS	
	Pneumatic cushioning, adjustable at both ends									-PPV	
Position sensing	Via proximity sensor									A	
Standard	Conforms to ISO 15552									-N3	
O Temperature range	Standard -20 ... +80 °C										
	Heat-resistant seals 0 ... +120 °C							4		T1	
	-40 ... +80 °C							4		T3	
	0 ... +150 °C							4		T4	
Wiper seal variant	None										
	Increased chemical resistance							5		A1	
	Hard scraper									A2	
	For unlubricated operation							5		A3	
EU certification	None										
	II 2GD							-		EX4	
Piston rod extension [mm]	1 ... 500							6		-...E	
Piston rod thread extension [mm]	1 ... 35			1 ... 70				6		-...L	
M Sensor mounting	Mounting rail for sensors									-R	

- 1** L, U Not with T, T1, T3, T4, A1, A2, A3 and EX4
- 2** F Not with ...L
- 3** PPS Not with T1, T3, T4, A1

- 4** T1, T3, T4 Not with A1, A2, A3, EX4
- 5** A1, A3 Not with EX4
- 6** ...E, ...L Only up to strokes of 2,000 mm

Transfer order code

DSBF - **C** - - - - - - - - - **A** - **N3** - - - - **R**

Standard cylinders DSBF-C, to ISO 1552, Clean Design



Accessories

Foot mounting CRHNC

Material:
High-alloy steel
Free of copper, PTFE and silicone

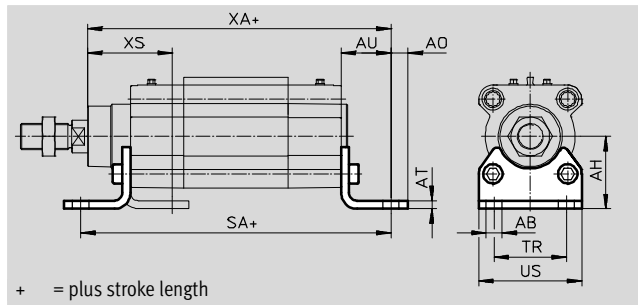

Dimensions and ordering data														
For \varnothing	AB \varnothing	AH	AO	AT	AU	SA	TR	US	XA	XS	CRC ¹⁾	Weight	Part No.	Type ²⁾
[mm]												[g]		
32	7	32	6.5	4	24	142	32	45	143.1	46	4	135	176937	CRHNC-32
40	10	36	9	4	28	161	36	54	161.9	52.7	4	180	176938	CRHNC-40
50	10	45	9.5	5	32	170	45	64	173.8	62.6	4	325	176939	CRHNC-50
63	10	50	12.5	5	32	185	50	75	189.1	62.9	4	405	176940	CRHNC-63
80	12	63	15	6	41	210	63	93	214.6	80.4	4	820	176941	CRHNC-80
100	14.5	71	17.5	6	41	220	75	110	228.5	84.3	4	1000	176942	CRHNC-100
125	16.5	90	22	8	45	250	90	131	270	102	4	1840	176943	CRHNC-125

- Corrosion resistance class CRC 4 to Festo standard FN 940070
Particularly high corrosion stress. Outdoor exposure under extreme corrosive conditions. Parts exposed to aggressive media, for instance in the chemical or food industries. These applications may need to be supported by special tests (→ also FN 940082) using appropriate media.
- ATEX-compliant

Flange mounting CRFNG

Material:
High-alloy steel
Free of copper, PTFE and silicone

Cannot be used on the bearing cap in combination with protective bellows kit DADB.

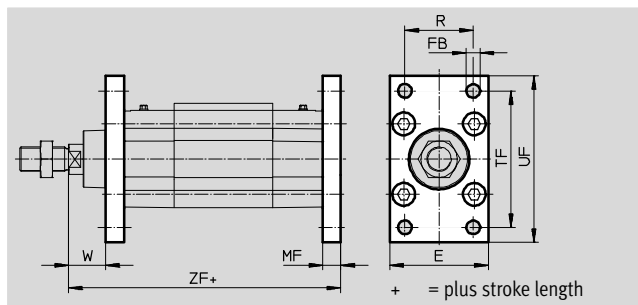
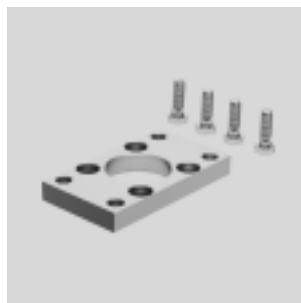

Dimensions and ordering data													
For \varnothing	E	FB \varnothing	MF	R	TF	UF	W	ZF	CRC ¹⁾	Weight	Part No.	Type ²⁾	
[mm]										[g]			
32	45	7	10	32	64	80	16	129.1	4	225	161846	CRFNG-32	
40	54	9	10	36	72	90	18.7	143.9	4	300	161847	CRFNG-40	
50	64	9	12	45	90	110	23.6	153.8	4	540	161848	CRFNG-50	
63	75	9	12	50	100	120	23.9	169.1	4	680	161849	CRFNG-63	
80	93	12	16	63	126	150	29.4	189.6	4	1500	161850	CRFNG-80	
100	110	14	16	75	150	175	33.3	203.5	4	2100	161851	CRFNG-100	
125	132	16	20	90	180	210	45	245	4	3787	185363	CRFNG-125	

- Corrosion resistance class CRC 4 to Festo standard FN 940070
Particularly high corrosion stress. Outdoor exposure under extreme corrosive conditions. Parts exposed to aggressive media, for instance in the chemical or food industries. These applications may need to be supported by special tests (→ also FN 940082) using appropriate media.
- ATEX-compliant

Standard cylinders DSBF-C, to ISO 1552, Clean Design

Accessories

Trunnion flange CRZNG

Material:
High-alloy steel
Free of copper, PTFE and silicone

Cannot be used on the bearing cap in combination with protective bellows kit DADB.

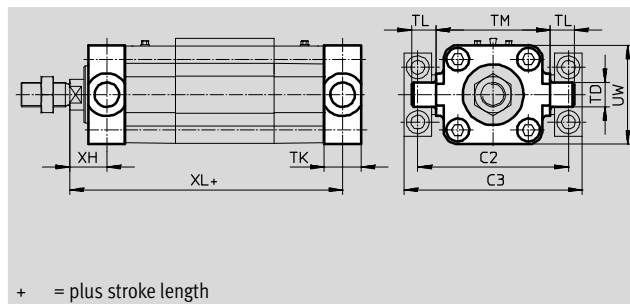

Dimensions and ordering data													
For Ø	C2	C3	TD	TK	TL	TM	UW	XH	XL	CRC ¹⁾	Weight	Part No.	Type ²⁾
[mm]			Ø								[g]		
32	71	86	12	16	12	50	45	18	127.1	4	150	161852	CRZNG-32
40	87	105	16	20	16	63	54	18.7	143.9	4	285	161853	CRZNG-40
50	99	117	16	24	16	75	64	23.6	153.8	4	473	161854	CRZNG-50
63	116	136	20	24	20	90	75	23.9	169.1	4	687	161855	CRZNG-63
80	136	156	20	28	20	110	93	31.4	187.6	4	1296	161856	CRZNG-80
100	164	189	25	38	25	132	110	30.3	206.5	4	2254	161857	CRZNG-100
125	192	217	25	50	25	160	131	40	250	4	3484	185362	CRZNG-125

- 1) Corrosion resistance class CRC 4 to Festo standard FN 940070
Particularly high corrosion stress. Outdoor exposure under extreme corrosive conditions. Parts exposed to aggressive media, for instance in the chemical or food industries. These applications may need to be supported by special tests (→ also FN 940082) using appropriate media.
- 2) ATEX-compliant

Trunnion support CRLNZG

Material:
High-alloy steel
Free of copper, PTFE and silicone

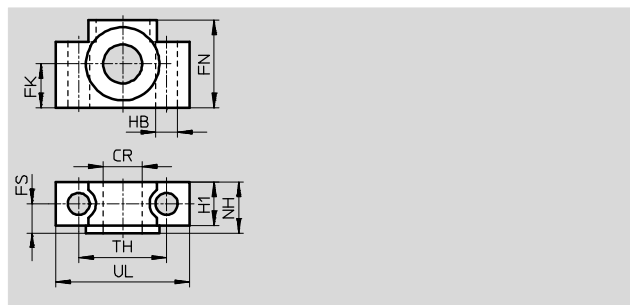

Dimensions and ordering data													
For Ø	CR	FK	FN	FS	H1	HB	NH	TH	UL	CRC ¹⁾	Weight	Part No.	Type
[mm]	Ø	Ø				Ø		±0.2			[g]		
32	12	15	30	10.5	15	6.6	18	32	46	4	205	161874	CRLNZG-32
40, 50	16	18	36	12	18	9	21	36	55	4	323	161875	CRLNZG-40/50
63, 80	20	20	40	13	20	11	23	42	65	4	435	161876	CRLNZG-63/80
100, 125	25	25	50	16	24.5	14	28.5	50	75	4	739	161877	CRLNZG-100/125

- 1) Corrosion resistance class CRC 4 to Festo standard FN 940070
Particularly high corrosion stress. Outdoor exposure under extreme corrosive conditions. Parts exposed to aggressive media, for instance in the chemical or food industries. These applications may need to be supported by special tests (→ also FN 940082) using appropriate media.

Standard cylinders DSBF-C, to ISO 15552, Clean Design



Accessories

Swivel flange SNCB-R3

Material:
Die-cast aluminium with protective coating
Free of copper and PTFE

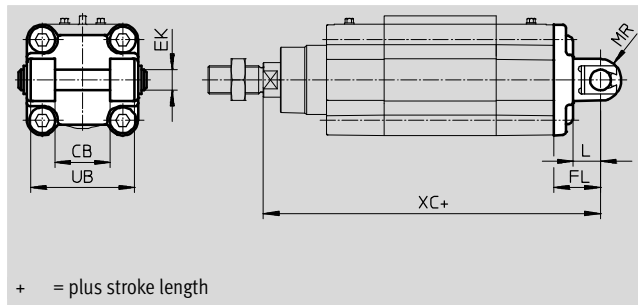

Dimensions and ordering data											
For Ø	CB	EK	FL	L	MR	UB	XC	CRC ¹⁾	Weight	Part No.	Type
[mm]	H14	∅ e8	±0.2			h14			[g]		
32	26	10	22	13	8.5	45	141.1	3	100	176944	SNCB-32-R3
40	28	12	25	16	12	52	158.9	3	151	176945	SNCB-40-R3
50	32	12	27	16	12	60	168.8	3	228	176946	SNCB-50-R3
63	40	16	32	21	16	70	189.1	3	371	176947	SNCB-63-R3
80	50	16	36	22	16	90	209.6	3	632	176948	SNCB-80-R3
100	60	20	41	27	20	110	228.5	3	986	176949	SNCB-100-R3
125	70	25	50	30	25	130	275	3	1776	176950	SNCB-125-R3

1) Corrosion resistance class CRC 3 to Festo standard FN 940070
High corrosion stress. Outdoor exposure under moderate corrosive conditions. External visible parts with primarily functional requirements for the surface and which are in direct contact with a normal industrial environment.

Ordering data – Mounting components			
Designation	For Ø	Part No.	Type
Clevis foot CRLNG			
	32	161840	CRLNG-32
	40	161841	CRLNG-40
	50	161842	CRLNG-50
	63	161843	CRLNG-63
	80	161844	CRLNG-80
	100	161845	CRLNG-100
	125	176951	CRLNG-125

Ordering data – Piston rod attachments, corrosion- and acid-resistant				Technical data → Internet: piston rod attachment			
	For Ø	Part No.	Type		For Ø	Part No.	Type
Rod eye CRSGS				Rod clevis CRSG ¹⁾			
	32	195582	CRSGS-M10x1,25		32	13569	CRSG-M10x1,25
	40	195583	CRSGS-M12x1,25		40	13570	CRSG-M12x1,25
	50, 63	195584	CRSGS-M16x1,5		50, 63	13571	CRSG-M16x1,5
	80, 100	195585	CRSGS-M20x1,5		80, 100	13572	CRSG-M20x1,5
	125	195586	CRSGS-M27x2		125	185361	CRSG-M27x2
Self-aligning rod coupler CRFK							
	32	2305778	CRFK-M10x1,25				
	40	2305779	CRFK-M12x1,25				
	50, 63	2490673	CRFK-M16x1,5				
	80, 100	2545677	CRFK-M20x1,5				

1) ATEX-compliant

Standard cylinders DSBF-C, to ISO 1552, Clean Design

Accessories

Protective bellows kit DADB



General technical data						
Type DADB-V6-	32	40	50	63	80	100
Max. stroke range of cylinder ¹⁾	[mm]	10 ... 500	10 ... 500	10 ... 500	10 ... 500	10 ... 500
Type of mounting	Via threaded pin					
Mounting position	Any					
Resistance to media	Dust, chippings, oil, grease, fuel (→ Internet: Resistance to media)					
Ambient temperature ²⁾	[°C]	-10 ... +80				
Protection class	IP54					
Corrosion resistance class CRC ³⁾	3					

1) In combination with protective bellows kit DADB

2) Note operating range of proximity sensors and cylinder

3) Corrosion resistance class CRC 3 to Festo standard FN 940070

High corrosion stress. Outdoor exposure under moderate corrosive conditions. External visible parts with primarily functional requirements for the surface and which are in direct contact with a normal industrial environment.

Materials

Sectional view

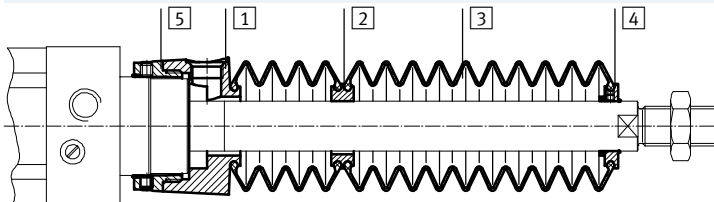

Bellows		
1	Connection	Polyamide
2	Adapter	Polyamide
3	Bellows	Nitrile rubber
4	End piece	Polyamide
5	Connector	Polyamide
-	O-ring	Nitrile rubber
Note on materials		Free of copper and PTFE
		RoHS-compliant

Weight [g]						
Type DADB-V6- Stroke [mm]	32	40	50	63	80	100
10 ... 50	29	42	71	69	99	124
51 ... 125	41	56	91	89	127	152
126 ... 175	52	68	105	103	140	165
176 ... 250	66	85	129	127	193	218
251 ... 300	79	100	147	145	231	255
301 ... 350	92	115	166	164	268	293
351 ... 375	92	115	167	165	259	284
376 ... 425	104	129	185	183	296	321
426 ... 475	117	144	204	202	334	359
476 ... 500	117	144	205	203	324	349

Standard cylinders DSBF-C, to ISO 15552, Clean Design

Accessories



Travel speed v as a function of tubing length l

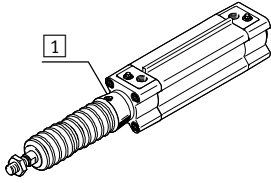

The bellows kit is a leak-free system. To prevent unwanted media from being drawn in, the supply and exhaust air must be ducted via a pressure compensation hole in the connection part **1**.

The pressure generated in the protective bellows kit by the positioning motion is primarily defined by the travel speed and tubing length. The recom-

mended tubing length based on the travel speed of the drive can be read from the graph.

Advance

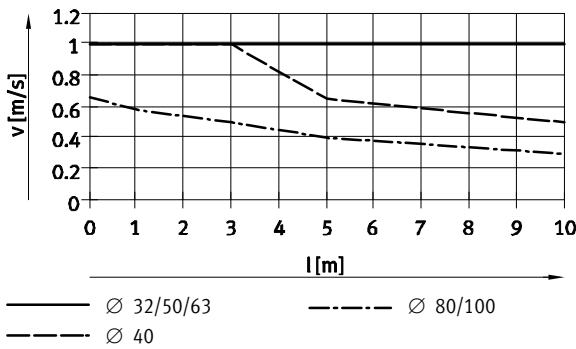

Return

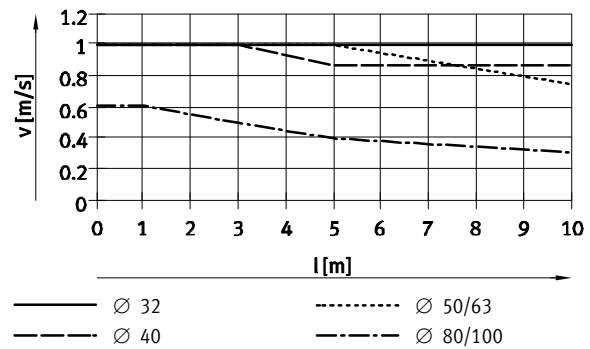

Note
The push-in fittings opposite must be used for the pressure compensation hole. Silencers can be used as an alternative. This reduces the travel speed slightly.

Tubing length and push-in fitting for pressure compensation hole			
Ø [mm]	Tubing O.D. [mm]	Push-in fitting	
		Part No.	Type
32, 40	8	186109	QS-G $\frac{1}{8}$ -8-I
		578376	NPQH-DK-G18-Q8-P10
		578362	NPQH-D-G18-S8-P10
50, 63, 80, 100	12	186350	QS-G $\frac{1}{4}$ -12
		578344	NPQH-D-G14-Q12-P10
		578366	NPQH-D-G14-S12-P10

Standard cylinders DSBF-C, to ISO 1552, Clean Design

Accessories

Dimensions Download CAD data → www.festo.com

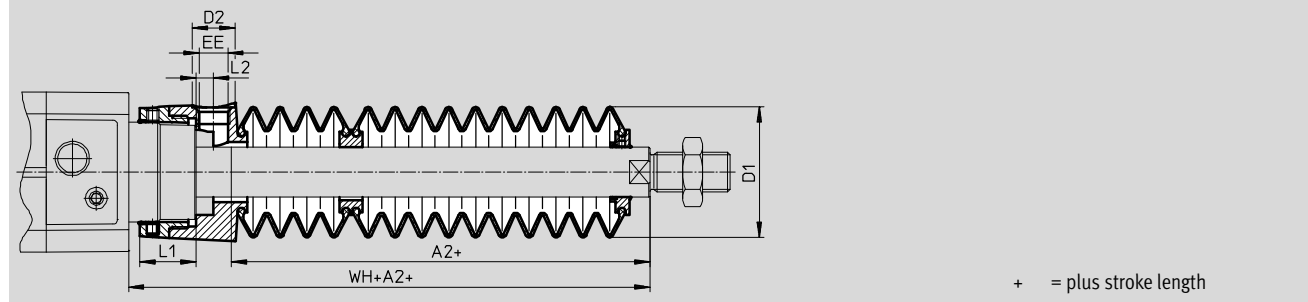

Ø Stroke [mm]	32							40						
	A2 ¹⁾	D1 max.	D2	EE	L1	L2	WH+A2	A2 ¹⁾	D1 max.	D2	EE	L1	L2	WH+A2
10 ... 50	29	38	14	G ¹ / ₈	12.9	5.4	55	28	46	14	G ¹ / ₈	16.3	5.4	56.7
51 ... 125	47						73	43						71.7
126 ... 175	61						87	56						84.7
176 ... 250	80						106	72						100.7
251 ... 300	96						122	86						114.7
301 ... 350	112						138	100						128.7
351 ... 375	114						140	101						129.7
376 ... 425	130						156	115						143.7
426 ... 475	145						171	130						158.7
476 ... 500	147						173	131						159.7

Ø Stroke [mm]	50							63						
	A2 ¹⁾	D1 max.	D2	EE	L1	L2	WH+A2	A2 ¹⁾	D1 max.	D2	EE	L1	L2	WH+A2
10 ... 50	28	57	17	G ¹ / ₄	22.35	7	63.6	28	57	17	G ¹ / ₄	22.4	7	63.9
51 ... 125	46						81.6	46						81.9
126 ... 175	56						91.6	56						91.9
176 ... 250	73						108.6	73						108.9
251 ... 300	86						121.6	86						121.9
301 ... 350	97						132.6	97						132.9
351 ... 375	105						140.6	105						140.9
376 ... 425	116						151.6	116						151.9
426 ... 475	126						161.6	126						161.9
476 ... 500	134						169.6	134						169.9

Ø Stroke [mm]	80							100						
	A2 ¹⁾	D1 max.	D2	EE	L1	L2	WH+A2	A2 ¹⁾	D1 max.	D2	EE	L1	L2	WH+A2
10 ... 50	25	93	17	G ¹ / ₄	28	4	70.4	25	93	17	G ¹ / ₄	28	4	74.3
51 ... 125	37						82.4	37						86.3
126 ... 175	49						94.4	49						98.3
176 ... 250	62						107.4	62						111.3
251 ... 300	74						119.4	74						123.3
301 ... 350	86						131.4	86						135.3
351 ... 375	87						132.4	87						136.3
376 ... 425	98						143.4	98						147.3
426 ... 475	110						155.4	110						159.3
476 ... 500	111						156.4	111						160.3

1) The dimension corresponds to the E value (extended piston rod) of the drive

Standard cylinders DSBF-C, to ISO 15552, Clean Design

Accessories

Ordering data – Protective bellows kit

An extended piston rod (order code ...E) → 21 is absolutely essential if a protective bellows kit is to be used.

The following table specifies the required dimension for E as a function of piston diameter and stroke of the cylinder as well as the associated bellows kit:

Order example:

Selected standard cylinder:

DSBF-C-32-320-PPV-A-N3-...E-R

The dimension for the corresponding E value (see table):

112 mm

Complete type code for standard cylinder:

DSBF-C-32-320-PPV-A-N3-112E-R

The corresponding protective bellows kit:

DADB-V6-32-S301-350

Cylinder data			Protective bellows kit		Cylinder data			Protective bellows kit	
∅	Stroke	Dimension for E	Part No.	Type	∅	Stroke	Dimension for E	Part No.	Type
[mm]	[mm]	[mm]			[mm]	[mm]	[mm]		
32	10 ... 50	29	553271	DADB-V6-32-S10-50	40	10 ... 50	28	553291	DADB-V6-40-S10-50
	51 ... 125	47	553273	DADB-V6-32-S51-125		51 ... 125	43	553293	DADB-V6-40-S51-125
	126 ... 175	61	553275	DADB-V6-32-S126-175		126 ... 175	56	553295	DADB-V6-40-S126-175
	176 ... 250	80	553277	DADB-V6-32-S176-250		176 ... 250	72	553297	DADB-V6-40-S176-250
	251 ... 300	96	553279	DADB-V6-32-S251-300		251 ... 300	86	553299	DADB-V6-40-S251-300
	301 ... 350	112	553281	DADB-V6-32-S301-350		301 ... 350	100	553301	DADB-V6-40-S301-350
	351 ... 375	114	553283	DADB-V6-32-S351-375		351 ... 375	101	553303	DADB-V6-40-S351-375
	376 ... 425	130	553285	DADB-V6-32-S376-425		376 ... 425	115	553305	DADB-V6-40-S376-425
	426 ... 475	145	553287	DADB-V6-32-S426-475		426 ... 475	130	553307	DADB-V6-40-S426-475
	476 ... 500	147	553289	DADB-V6-32-S476-500		476 ... 500	131	553309	DADB-V6-40-S476-500
50	10 ... 50	28	553311	DADB-V6-50-S10-50	63	10 ... 50	28	553331	DADB-V6-63-S10-50
	51 ... 125	46	553313	DADB-V6-50-S51-125		51 ... 125	46	553333	DADB-V6-63-S51-125
	126 ... 175	56	553315	DADB-V6-50-S126-175		126 ... 175	56	553335	DADB-V6-63-S126-175
	176 ... 250	73	553317	DADB-V6-50-S176-250		176 ... 250	73	553337	DADB-V6-63-S176-250
	251 ... 300	86	553319	DADB-V6-50-S251-300		251 ... 300	86	553339	DADB-V6-63-S251-300
	301 ... 350	97	553321	DADB-V6-50-S301-350		301 ... 350	97	553341	DADB-V6-63-S301-350
	351 ... 375	105	553323	DADB-V6-50-S351-375		351 ... 375	105	553343	DADB-V6-63-S351-375
	376 ... 425	116	553325	DADB-V6-50-S376-425		376 ... 425	116	553345	DADB-V6-63-S376-425
	426 ... 475	126	553327	DADB-V6-50-S426-475		426 ... 475	126	553347	DADB-V6-63-S426-475
	476 ... 500	134	553329	DADB-V6-50-S476-500		476 ... 500	134	553349	DADB-V6-63-S476-500
80	10 ... 50	25	553351	DADB-V6-80-S10-50	100	10 ... 50	25	553371	DADB-V6-100-S10-50
	51 ... 125	37	553353	DADB-V6-80-S51-125		51 ... 125	37	553373	DADB-V6-100-S51-125
	126 ... 175	49	553355	DADB-V6-80-S126-175		126 ... 175	49	553375	DADB-V6-100-S126-175
	176 ... 250	62	553357	DADB-V6-80-S176-250		176 ... 250	62	553377	DADB-V6-100-S176-250
	251 ... 300	74	553359	DADB-V6-80-S251-300		251 ... 300	74	553379	DADB-V6-100-S251-300
	301 ... 350	86	553361	DADB-V6-80-S301-350		301 ... 350	86	553381	DADB-V6-100-S301-350
	351 ... 375	87	553363	DADB-V6-80-S351-375		351 ... 375	87	553383	DADB-V6-100-S351-375
	376 ... 425	98	553365	DADB-V6-80-S376-425		376 ... 425	98	553385	DADB-V6-100-S376-425
	426 ... 475	110	553367	DADB-V6-80-S426-475		426 ... 475	110	553387	DADB-V6-100-S426-475
	476 ... 500	111	553369	DADB-V6-80-S476-500		476 ... 500	111	553389	DADB-V6-100-S476-500



Standard cylinders DSBF-C, to ISO 1552, Clean Design

Accessories

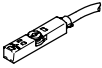
Ordering data – Mounting kit		Part No.	Type
	Description For mounting the proximity sensor CRSMT-8M on the mounting rail	1806790	SMB-8-C

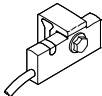
Ordering data – Proximity sensor for T-slot, magneto-resistive					Technical data → Internet: smt		
Type of mounting	Switching output	Electrical connection	Cable length [m]	Part No.	Type		
N/O contact							
	Insertable in the slot from above, flush with the mounting kit	PNP	Cable, 3-wire	5.0	574380	CRSMT-8M-PS-24V-K-5,0-OE	
			Cable, 3-wire	10.0	574381	CRSMT-8M-PS-24V-K-10,0-OE	
				Plug M8x1, 3-pin	0.3	574383	CRSMT-8M-PS-24V-K-0,3-M8D
				Plug M12x1, 3-pin	0.3	574382	CRSMT-8M-PS-24V-K-0,3-M12





Ordering data – Proximity sensor for T-slot, magneto-resistive					Technical data → Internet: smt			
Type of mounting	Switching output	Electrical connection	Cable length [m]	Part No.	Type			
N/O contact								
	Is mounted on the mounting rail	PNP	Cable, 3-wire	5.0	571339	SMT-C1-PS-24V-K-5,0-OE		
					Plug M8x1, 3-pin	0.3	571342	SMT-C1-PS-24V-K-0,3-M8D
					Plug M12x1, 3-pin	0.3	571341	SMT-C1-PS-24V-K-0,3-M12

Ordering data – Connecting cables				Technical data → Internet: nebu	
Electrical connection, left	Electrical connection, right	Cable length [m]	Part No.	Type	
	Straight socket, M8x1, 3-pin	Cable, open end, 3-wire	2.5	541333	NEBU-M8G3-K-2.5-LE3
		Cable, open end, 3-wire	5	541334	NEBU-M8G3-K-5-LE3
	Straight socket, M12x1, 5-pin	Cable, open end, 3-wire	2.5	541363	NEBU-M12G5-K-2.5-LE3
		Cable, open end, 3-wire	5	541364	NEBU-M12G5-K-5-LE3
	Angled socket, M8x1, 3-pin	Cable, open end, 3-wire	2.5	541338	NEBU-M8W3-K-2.5-LE3
		Cable, open end, 3-wire	5	541341	NEBU-M8W3-K-5-LE3
	Angled socket, M12x1, 5-pin	Cable, open end, 3-wire	2.5	541367	NEBU-M12W5-K-2.5-LE3
		Cable, open end, 3-wire	5	541370	NEBU-M12W5-K-5-LE3

Standard cylinders DSBF-C, to ISO 15552, Clean Design

FESTO

Accessories

Ordering data – Push-in fittings				Technical data → Internet: quick star						
Image	Connection		Material	Weight [g]	Part No.	Type	PU ¹⁾			
	Thread	Tubing O.D.								
With external hexagon										
	G $\frac{1}{8}$	4	Brass, nickel-plated, with sealing ring	6.1	578338	NPQH-D-G18-Q4-P10	10			
		6		9	578339	NPQH-D-G18-Q6-P10				
		8		11.4	578340	NPQH-D-G18-Q8-P10				
	G $\frac{1}{4}$	6		12.7	578341	NPQH-D-G14-Q6-P10				
		8		13.6	578342	NPQH-D-G14-Q8-P10				
		10		17.4	578343	NPQH-D-G14-Q10-P10				
	G $\frac{3}{8}$	8		20.1	578345	NPQH-D-G38-Q8-P10				
		10		22.6	578346	NPQH-D-G38-Q10-P10				
	G $\frac{1}{2}$	10		34.5	578349	NPQH-D-G12-Q10		1		
		12		36.1	578350	NPQH-D-G12-Q12				
		R $\frac{1}{8}$		6	Stainless steel, with PTFE coating	9.9	162862	CRQS- $\frac{1}{8}$ -6	1	
				8		12	162863	CRQS- $\frac{1}{8}$ -8		
R $\frac{1}{4}$		8	18	162864		CRQS- $\frac{1}{4}$ -8				
		10	22	162865		CRQS- $\frac{1}{4}$ -10				
R $\frac{3}{8}$		10	29	162866		CRQS- $\frac{3}{8}$ -10				
		12	37	162867		CRQS- $\frac{3}{8}$ -12				
R $\frac{1}{2}$		12	55	162868		CRQS- $\frac{1}{2}$ -12				
		16	59	162869		CRQS- $\frac{1}{2}$ -16				
With internal hexagon										
		G $\frac{1}{8}$	4	Brass, nickel-plated, with sealing ring		–	578374	NPQH-DK-G18-Q4-P10		10
			6			–	578375	NPQH-DK-G18-Q6-P10		
			8			–	578376	NPQH-DK-G18-Q8-P10		
	G $\frac{1}{4}$	8	–		578377	NPQH-DK-G14-Q8-P10				
		10	–		578378	NPQH-DK-G14-Q10-P10				
	G $\frac{3}{8}$	12	–		578379	NPQH-DK-G38-Q12-P10				
With external hexagon										
	G $\frac{1}{8}$	4	Brass, nickel-plated, with sealing ring	15.7	578280	NPQH-L-G18-Q4-P10	10			
		6		18.5	578281	NPQH-L-G18-Q6-P10				
		8		22	578282	NPQH-L-G18-Q8-P10				
	G $\frac{1}{4}$	6		21.8	578283	NPQH-L-G14-Q6-P10				
		8		25.3	578284	NPQH-L-G14-Q8-P10				
		10		34	578285	NPQH-L-G14-Q10-P10				
	G $\frac{3}{8}$	8		37.7	578287	NPQH-L-G38-Q8-P10				
		10		39.2	578288	NPQH-L-G38-Q10-P10				
	G $\frac{1}{2}$	10		43.2	578291	NPQH-L-G12-Q10		1		
		12		65.1	578292	NPQH-L-G12-Q12				
		R $\frac{1}{8}$		6	Stainless steel, with PTFE coating	19	162872	CRQSL- $\frac{1}{8}$ -6	1	
				8		26	162873	CRQSL- $\frac{1}{8}$ -8		
R $\frac{1}{4}$		8	30	162874		CRQSL- $\frac{1}{4}$ -8				
		10	42	162875		CRQSL- $\frac{1}{4}$ -10				
R $\frac{3}{8}$		10	49	162876		CRQSL- $\frac{3}{8}$ -10				
		12	65	162877		CRQSL- $\frac{3}{8}$ -12				
R $\frac{1}{2}$		12	85	162878		CRQSL- $\frac{1}{2}$ -12				
		16	99	162879		CRQSL- $\frac{1}{2}$ -16				

1) Packaging unit quantity

Standard cylinders DSBF-C, to ISO 15552, Clean Design

Accessories

Ordering data – Plastic tubing, standard O.D.		Technical data → Internet: tubing
		Type
	Good resistance to chemicals and hydrolysis	PLN
	Pneumatic tubing with resistance to high temperatures and chemicals	PFAN
	Approved for use in the food industry and resistant to hydrolysis	PUN-H

Ordering data – One-way flow control valves				Technical data → Internet: crgrla		
	Connection		Material	Weight [g]	Part No.	Type
	Thread	For push-in fitting				
	G1/8	CRQS/CRQSL/CRQST, Quick Star	Electrolytically polished stainless steel casting	44	161404	CRGRLA-1/8-B
	G1/4			83	161405	CRGRLA-1/4-B
	G3/8			150	161406	CRGRLA-3/8-B
	G1/2			315	161407	CRGRLA-1/2-B

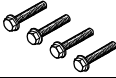
Ordering data – Blanking screws, corrosion-resistant							
	For Ø	Material	CRC ¹⁾	Weight [g]	Part No.	Type ³⁾	PU ²⁾
	32, 40	High-alloy steel	3	7	1355016	DAMD-PS-M6-12-R1	4
	50, 63		3	14	650121	DAMD-PS-M8-16-R1	
	80, 100		3	23	1355026	DAMD-PS-M10-16-R1	

- 1) Corrosion resistance class CRC 3 to Festo standard FN 940070
High corrosion stress. Outdoor exposure under moderate corrosive conditions. External visible parts with primarily functional requirements for the surface and which are in direct contact with a normal industrial environment.
- 2) Packaging unit
- 3) ATEX-compliant