















Standard cylinders DNCI, with integrated displacement encoder



# Cylinders with displacement encoder

Product range overview

Function	Type	Description
Drives	<b>Rodless</b>	
	DDLI 	<ul style="list-style-type: none"> <li>• Without guide</li> <li>• With contactless measuring displacement encoder</li> <li>• Based on linear drive DGC-K</li> <li>• Supply ports on end face</li> <li>• System product for handling and assembly technology</li> </ul>
	DDCI 	<ul style="list-style-type: none"> <li>• With guide</li> <li>• With contactless measuring displacement encoder</li> <li>• Based on linear drive DGC</li> <li>• Supply ports optionally on end face or front</li> <li>• System product for handling and assembly technology</li> </ul>
	<b>With piston rod</b>	
	DNCI 	<ul style="list-style-type: none"> <li>• With contactless measuring displacement encoder</li> <li>• Various piston rod variants</li> <li>• Standards-based cylinder to ISO 15552</li> </ul> <p>    </p>
	DDPC 	<ul style="list-style-type: none"> <li>• With contactless measuring displacement encoder</li> <li>• Various piston rod variants</li> <li>• Standards-based cylinder to ISO 15552</li> </ul> <p>    </p>
DNC/DSBC 	<ul style="list-style-type: none"> <li>• With attached potentiometer MLO-LWG</li> <li>• Various piston rod variants</li> <li>• Standards-based cylinder to ISO 15552</li> </ul> <p>    </p>	
Swivel modules	<b>Swivel modules</b>	
	DSMI 	<ul style="list-style-type: none"> <li>• Based on swivel modules DSM</li> <li>• Integrated rotary potentiometer</li> <li>• Compact design</li> <li>• Wide range of mounting options</li> </ul>

# Cylinders with displacement encoder

Product range overview



Piston Ø	Stroke/swivel angle [mm/°]	Suitable				
		for positioning with		for end-position controller		for use as a measuring cylinder
		CPX-CMAX	CPX-CMPX	SPC11		
<b>Rodless</b>						
25, 32, 40, 63	100, 160, 225, 300, 360, 450, 500, 600, 750, 850, 1000, 1250, 1500, 1750, 2000	■	■	■	■	
18, 25, 32, 40, 63	100, 160, 225, 300, 360, 450, 500, 600, 750, 850, 1000, 1250, 1500, 1750, 2000	■	■	■	■	
<b>With piston rod</b>						
32, 40, 50, 63	10 ... 2000	-	-	-	■	
	100 ... 750	■	■	■	-	
80, 100	10 ... 2000	-	-	-	■	
	100 ... 750	■	■	■	-	
32, 40, 50, 63, 80	100, 150, 225, 300, 360, 450, 600, 750	■	■	■	■	
<b>Swivel modules</b>						
25, 40, 63	270	■	■	■	■	

# Cylinders with displacement encoder

Features



## Servopneumatic drive technology

Positioning and Soft Stop applications as an integral component of the valve terminal CPX – the modular peripheral system for decentralised automation tasks.

The modular design means that valves, digital inputs and outputs, positioning modules and end-position controllers, as appropriate to the application, can be combined in almost any way on the CPX terminal.

Advantages:

- Pneumatics and electrics – control and positioning on one platform
- Innovative positioning technology – piston rod drives, rodless drives, rotary drives
- Actuation via fieldbus
- Remote maintenance, remote diagnostics, web server, SMS and e-mail alerts are all possible via TCP/IP
- Modules can be quickly exchanged and expanded without altering the wiring

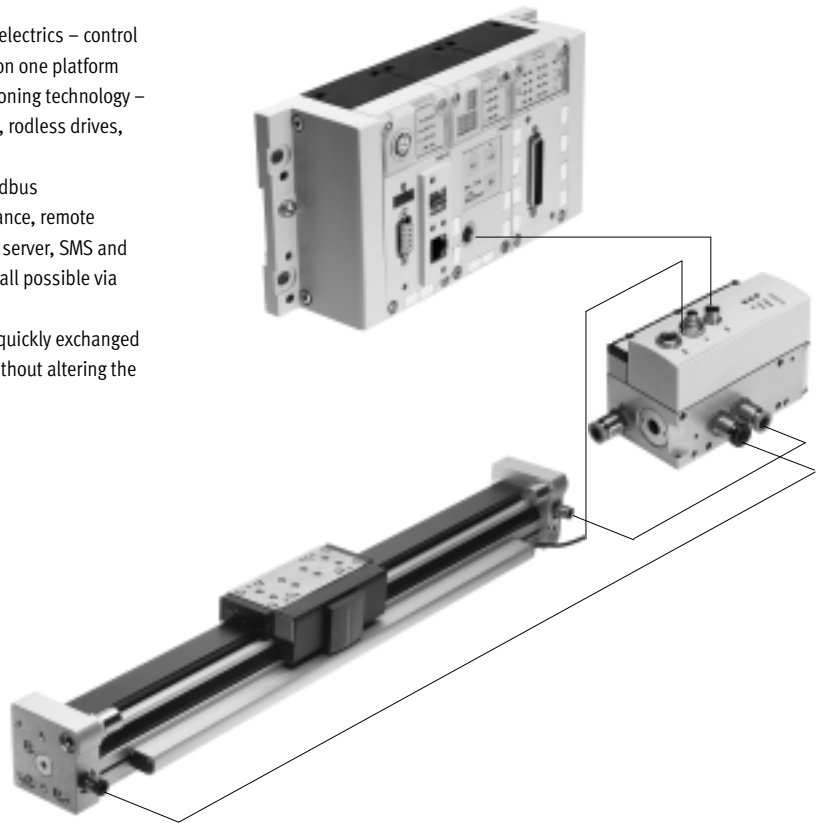

## Axis controller CPX-CMAX



Free choice:

Position and force control, directly actuated or selected from one of 64 configurable position sets. If you are looking for something more: the configurable function for switching to the next set enables simple functional sequences to be realised with the axis controller CPX-CMAX.

All stations are recognised as: the auto-identification function identifies each participant with its device data on the controller CPX-CMAX.

Also included:

The functional scope of the controller CPX-CMAX includes actuation of a brake or clamping unit via the proportional directional control valve VPWP.

Up to 8 modules (max. 8 axes) can be operated in parallel and independently of each other. Commissioning via FCT (Festo configuration software) or via fieldbus: no programming, only configuration.

Technical data → Internet: [cpx-cmax](http://cpx-cmax)

Advantages:

- Greater flexibility
- OEM friendly – commissioning also via fieldbus
- Easy installation and fast commissioning
- Cost-effective
- You program the system in your PLC environment

# Cylinders with displacement encoder

Features

**FESTO**

## End-position controller CPX-CMPX



Fast travel between the mechanical end stops of the cylinder, stopping gently and without impact in the end position.  
Fast commissioning via control panel, fieldbus or handheld unit. Improved control of downtime. Actuation of a brake or clamping unit via the proportional directional control valve VPWP is an integral part of the controller CMPX.

Depending on the fieldbus chosen, up to 9 end-position controllers can be actuated on the CPX terminal. All system data can be read and written via the fieldbus, including, for example, the mid positions.

## Technical data → Internet: cpx-cmpx

- Advantages:
- Greater flexibility
  - OEM friendly – commissioning also via fieldbus
  - Easy installation and fast commissioning
  - Cost-effective
    - up to 30% faster cycle rates
    - significantly reduced system vibration
  - Improved work ergonomics thanks to significantly reduced noise level
  - The extended diagnostics help to reduce the service time of the machine

## Proportional directional control valve VPWP



The 5/3-way proportional directional control valve for applications with Soft Stop and pneumatic positioning. Fully digitalised – with integrated pressure sensors, with new diagnostic functions. In sizes 4, 6, 8 and 10. Flow rate of 350, 700, 1400 and 2000 l/min.

With switching output for actuating a brake. Coloured supply ports. Pre-assembled cables guarantee faultless and fast connection with the controllers CPX-CMPX and CPX-CMAX.

## Technical data → Internet: vpwp

- Advantages:
- Easy installation and fast commissioning
  - Reduction of system downtimes thanks to the new diagnostic options
  - With switching output for actuating a brake/clamping unit

## Measuring module CPX-CMIX



Fully digital data acquisition and transmission means that pneumatic cylinders can be used as sensors. With very high repetition accuracy and incorporating both analogue and digital measuring sensors.

Suitable for the linear drive DGCI with displacement encoder for measuring absolute values, for the piston rod drive DNCI/DDPC with incremental displacement encoder or even for a potentiometer of the type MLO.

## Technical data → Internet: cpx-cmix

- Advantages:
- All process steps can be documented, which improves quality
  - An adjustable contact force (via pressure regulator) increases the precision of the "displacement sensor"
  - With displacement encoders for measuring absolute values, the actual position is immediately available after the system is switched on

# Cylinders with displacement encoder

Drive options

FESTO

## System with linear drive DDLI, DGCI

Technical data → Internet: [ddli](#) or [dgci](#)

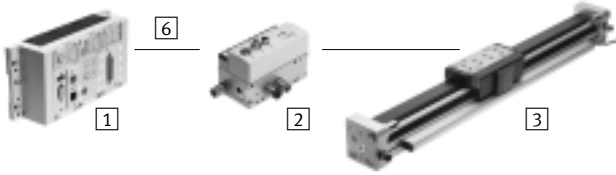

- 1 Controller module CPX-CMPX or CPX-CMAX
- 2 Proportional directional control valve VPWP
- 3 Linear drive DDLI, DGCI with displacement encoder
- 6 Connecting cable KVI-CP-3-...

- Pneumatic rodless linear drive with displacement encoder, with or without recirculating ball bearing guide
- Displacement encoder with absolute and contactless measurement
- Diameters:
  - DGCI: 18 ... 63 mm
  - DDLI: 25 ... 63 mm
- Stroke: 100 ... 2000 mm in fixed lengths
- Range of applications: Soft Stop and pneumatic positioning
- Loads from 1 ... 180 kg
- No sensor interface required

Advantages:

- Complete drive unit
- DDLI for easy connection to customer's guide system
- Excellent running characteristics
- For fast and accurate positioning down to  $\pm 0.2$  mm (only with axis controller CPX-CMAX)

## System with standard cylinder DNCI, DDPC

Technical data → Internet: [dncl](#)

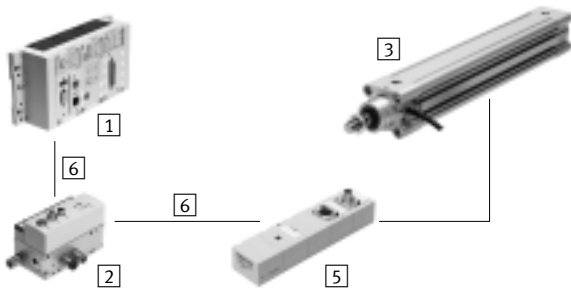

- 1 Controller module CPX-CMPX or CPX-CMAX
- 2 Proportional directional control valve VPWP
- 3 Standard cylinder DNCI, DDPC with displacement encoder
- 5 Sensor interface CASM-S-D3-R7
- 6 Connecting cable KVI-CP-3-...

- Standard cylinder with integrated displacement encoder, conforms to DIN ISO 6432, VDMA 24 562, NF E 49 003.1 and Uni 10 290
- Displacement encoder with contactless and incremental measuring
- Diameter: 32 ... 100 mm
- Stroke: 100 ... 750 mm
- Range of applications: Soft Stop and pneumatic positioning
- Loads from 3 ... 450 kg and a matching sensor interface CASM-S-D3-R7
- Pre-assembled cables guarantee faultless and fast electrical connection

Advantages:

- Compact drive unit
- Can be used universally
- Also with guide unit
- For fast and accurate positioning up to  $\pm 0.5$  mm (only with axis controller CPX-CMAX)

# Cylinders with displacement encoder

Drive options

FESTO

## System with swivel module DSMI

Technical data → Internet: [dsmi](#)

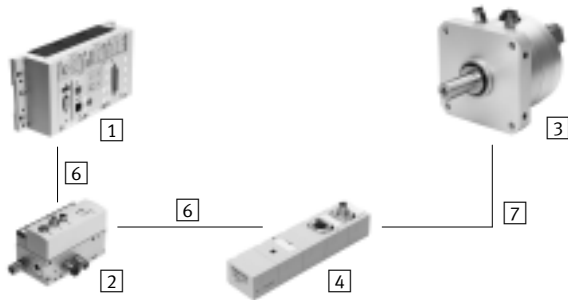

- 1 Controller module CPX-CMPX or CPX-CMAX
- 2 Proportional directional control valve VPWP
- 3 Swivel module DSMI with displacement encoder
- 4 Sensor interface CASM-S-D2-R3
- 6 Connecting cable KVI-CP-3-...
- 7 Connecting cable NEBC-P1W4-K-0,3-N-M12G5

- Swivel module DSMI with integrated displacement encoder
- Identical design to pneumatic swivel module DSM
- Absolute displacement encoder based on a potentiometer
- Swivel range of 0 ... 270°
- Size: 25, 40, 63
- Max. torque: 5 ... 40 Nm
- Range of applications: Soft Stop and pneumatic positioning
- Mass moments of inertia from 15 ... 6000 kgcm<sup>2</sup> and a matching sensor interface CASM-S-D2-R3
- Pre-assembled cables guarantee faultless and fast connection with the proportional directional control valve VPWP

Advantages:

- Complete drive unit, compact, can be used immediately
- High angular acceleration
- With adjustable fixed stops
- For fast and accurate positioning down to ±0.2° (only with axis controller CPX-CMAX)

## System with potentiometer

Technical data → Internet: [casm](#)

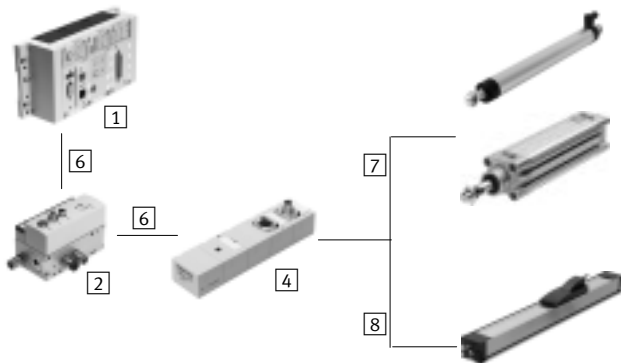

- 1 Controller module CPX-CMPX or CPX-CMAX
- 2 Proportional directional control valve VPWP
- 4 Sensor interface CASM-S-D2-R3
- 6 Connecting cable KVI-CP-3-...
- 7 Connecting cable NEBC-P1W4-K-0,3-N-M12G5
- 8 Connecting cable NEBC-A1W3-K-0,4-N-M12G5

- Attachable potentiometers with absolute measurement, with high degree of protection
- With connecting rod or moment compensator
- Measuring range:  
Connecting rod: 100 ... 750 mm  
Moment compensator: 225 ... 2000 mm
- Pre-assembled cables guarantee faultless and fast connection with the sensor interface CASM
- Range of applications: Soft Stop and pneumatic positioning with cylinder Ø 25 ... 80 mm, e.g. DNC or DSBC
- Loads from 1 ... 300 kg

Advantages:

- Easy installation and fast commissioning
- Cost-effective
- Can also be used in harsh ambient conditions
- Variety of drives: CPX-CMPX and CPX-CMAX also support cylinders with external displacement encoder

# Cylinders with displacement encoder

Drive options

System components for Soft Stop systems with end-position controller CPX-CMPX						
	Linear drive	Standard cylinder	Swivel module	Displacement encoder		→ Page/ Internet
	DDLI/DGCI	DNCI, DDPC	DSMI	MLO-LWG/-TLF	MME-MTS	
End-position controller CPX-CMPX	■	■	■	■	■	cmpx
Prop. directional control valve VPWP	■	■	■	■	■	vpwp
Sensor interface CASM-S-D2-R3	-	-	■	■	-	casm
Sensor interface CASM-S-D3-R7	-	■	-	-	-	casm
Connecting cable KVI-CP-3-...	■	■	■	■	■	kvi
Connecting cable NEBC-P1W4-...	-	-	■	■ / -	-	nebc
Connecting cable NEBC-A1W3-...	-	-	-	- / ■	-	nebc
Connecting cable NEBP-M16W6-...	-	-	-	-	■	nebp

System components for pneumatic positioning systems with axis controller CPX-CMAX						
	Linear drive	Standard cylinder	Swivel module	Displacement encoder		→ Page/ Internet
	DDLI/DGCI	DNCI, DDPC	DSMI	MLO-LWG/-TLF	MME-MTS	
Axis controller CPX-CMAX	■	■	■	■	■	cmax
Prop. directional control valve VPWP	■	■	■	■	■	vpwp
Sensor interface CASM-S-D2-R3	-	-	■	■	-	casm
Sensor interface CASM-S-D3-R7	-	■	-	-	-	casm
Connecting cable KVI-CP-3-...	■	■	■	■	■	kvi
Connecting cable NEBC-P1W4-...	-	-	■	■ / -	-	nebc
Connecting cable NEBC-A1W3-...	-	-	-	- / ■	-	nebc
Connecting cable NEBP-M16W6-...	-	-	-	-	■	nebp

System components for measuring cylinders with measuring module CPX-CMIX						
	Linear drive	Standard cylinder	Swivel module	Displacement encoder		→ Page/ Internet
	DDLI/DGCI	DNCI, DDPC	DSMI	MLO-LWG/-TLF	MME-MTS	
Measuring module CPX-CMIX-M1-1	■	■	■	■	■	cmix
Sensor interface CASM-S-D2-R3	-	-	■	■	-	casm
Sensor interface CASM-S-D3-R7	-	■	-	-	-	casm
Connecting cable KVI-CP-3-...	(■) <sup>1)</sup>	■	■	■	(■)	kvi
Connecting cable NEBC-P1W4-...	-	-	■	■ / -	-	nebc
Connecting cable NEBC-A1W3-...	-	-	-	- / ■	-	nebc
Connecting cable NEBP-M16W6-...	-	-	-	-	■	nebp

1) As an extension



# Cylinders with displacement encoder

Overview

## Individual components for positioning

With end-position controller SPC11

→ Internet: spc11

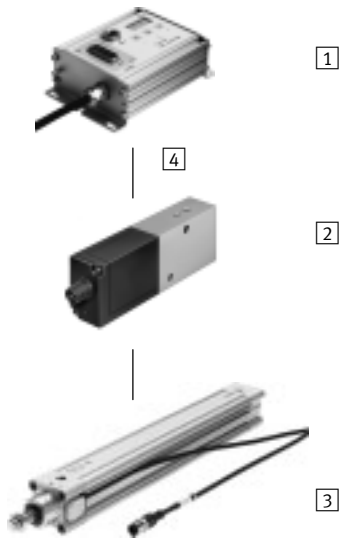

- 1 End-position controller SPC11-INC
- 2 Proportional directional control valve MPYE
- 3 Standard cylinder DNCI, DDPC
- 4 Connecting cable KMPYE-AIF-...

## Individual components for use as a measuring cylinder

With measuring module CPX-CMIX

→ Internet: cmix

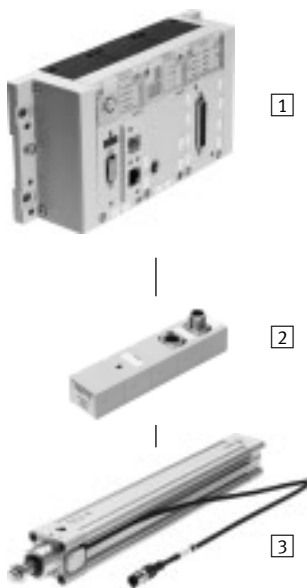

- 1 Measuring module CPX-CMIX
- 2 Sensor interface CASM-S-D3-R7
- 3 Standard cylinder DNCI, DDPC

With measured-value transducer DADE

→ Internet: dade

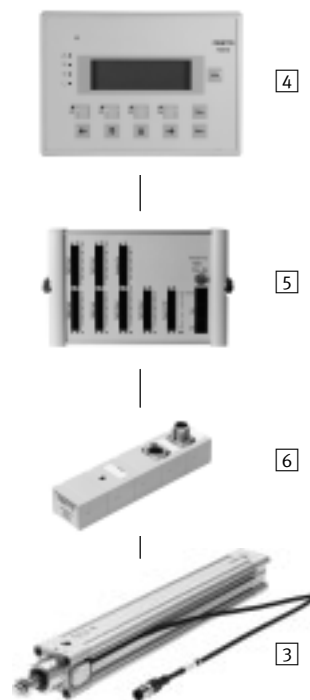

- 3 Standard cylinder DNCI, DDPC
- 4 Operator unit FED
- 5 PLC controller FEC
- 6 Measured-value transducer DADE

# Standard cylinders DNCI, with integrated displacement encoder

Type codes

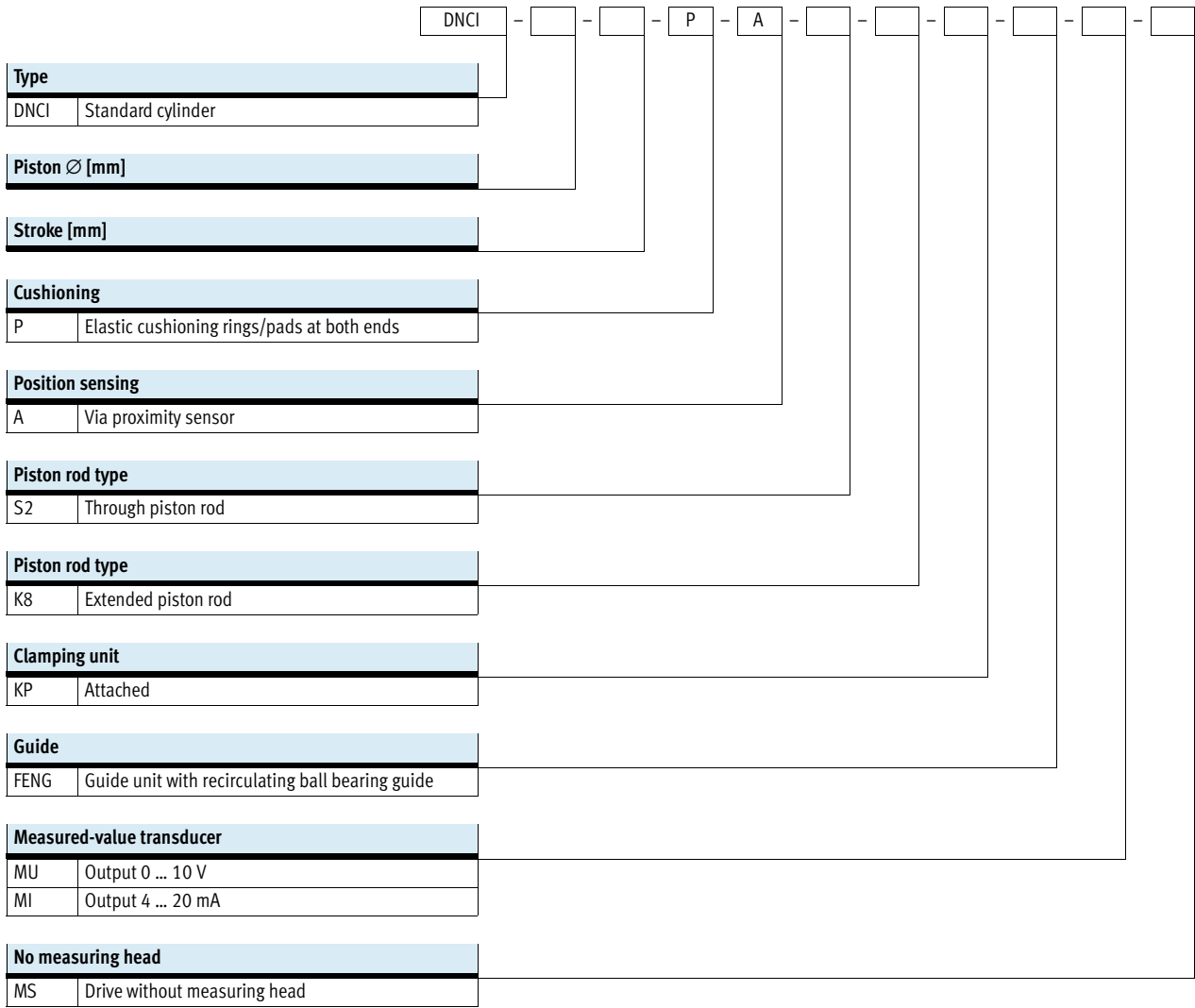

# Standard cylinders DNCI, with integrated displacement encoder

Peripherals overview

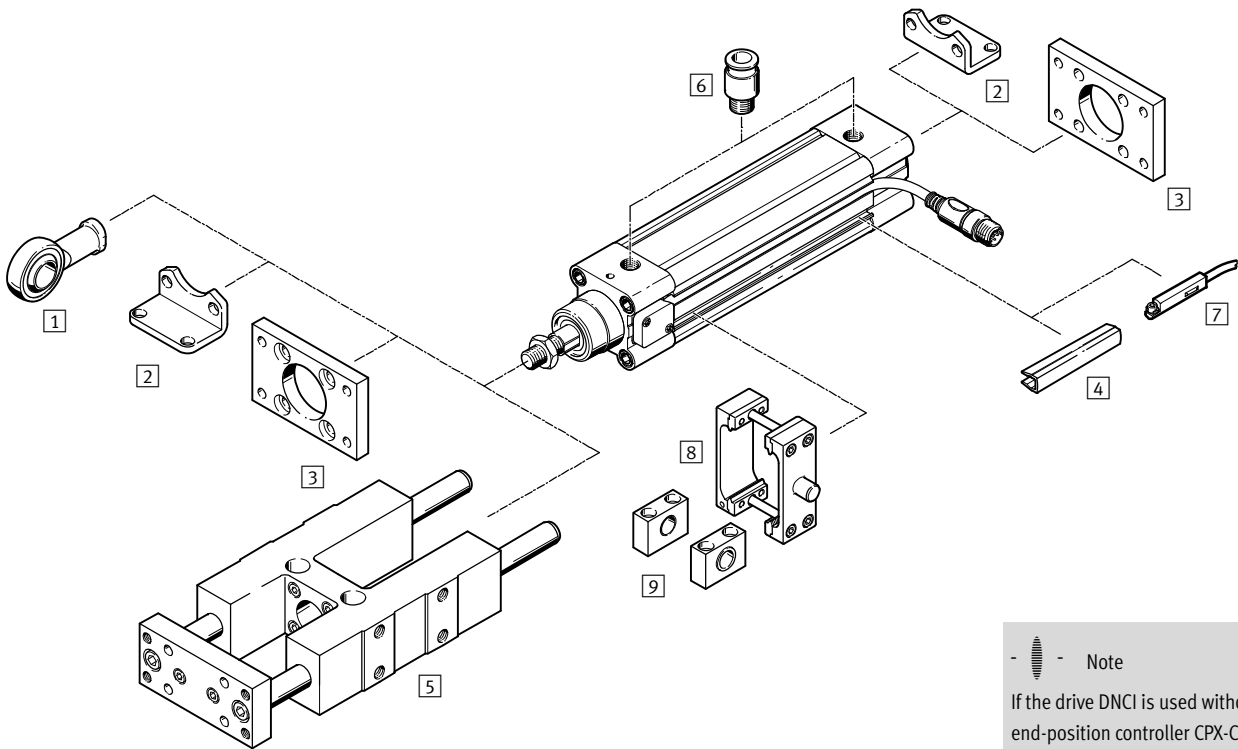

**Note**  
 If the drive DNCI is used without an end-position controller CPX-CMPX, SPC11 or axis controller CPX-CMAX, e.g. as a measuring cylinder, then the standard accessories for the drive DNC can be used.

Accessories		
Type	Description	→ Page/Internet
1 Rod eye SGS	With spherical bearing	25
2 Foot mounting HNC	For mounting the drive on the bearing and end cap	24
3 Flange mounting FNC	For mounting the drive on the bearing and end cap	25
4 Slot cover ABP-5-S	For protecting against the ingress of dirt	27
5 Guide unit <sup>1)</sup> FENG-KF	For protecting against rotation at high torque loads	22
6 Push-in fitting QS	For connecting compressed air tubing with standard O.D.	27
7 Proximity sensor SME/SMT-8	For additional sensing of the piston position, can be ordered optionally, only in combination with the order code A in the modular products section for the drive	proximity sensor
8 Trunnion mounting kit DAMT	For swivelling movements of the drive	26
9 Trunnion support LNZG	For securing the trunnion mounting kit DAMT	26

1) Guide unit FENG-KF must be attached to the piston rod in a way that eliminates backlash



# Standard cylinders DNCI, with integrated displacement encoder

FESTO

Technical data

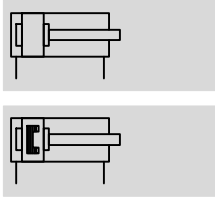
Function



-  - Diameter  
32 ... 63 mm
-  - Stroke length  
10 ... 2000 mm

General technical data				
Piston Ø	32	40	50	63
Based on standard	ISO 15552			
Design	Piston			
	Piston rod			
	Profile barrel			
Mode of operation	Double-acting			
Guide <sup>1)</sup>	Guide rod with yoke, with ball bearing guide			
Mounting position	Any			
Type of mounting	Via accessories			
Cushioning	Elastic cushioning rings/pads at both ends			
Position sensing	Integrated displacement encoder			
	Via proximity sensor <sup>2)</sup>			
Measuring principle (displacement encoder)	Encoder, contactless and relative measurement			
Pneumatic connection	G1/8	G1/4	G1/4	G3/8
Stroke	DNCI-... <sup>3)</sup>	[mm]	10 ... 2000	
	DNCI-...-FENG	[mm]	100 ... 500	
	Extended piston rod	[mm]	1 ... 500	

- 1) Guide unit FENG-KF can be ordered via the modular product system (feature FENG) and is supplied attached. The maximum stroke is restricted
- 2) Not included in the scope of delivery, can be ordered as an option
- 3) Can only be used without restriction as a positioning drive in the range from 100 ... 750 mm.  
Note stroke reduction in combination with CPX-CMAX

# Standard cylinders DNCI, with integrated displacement encoder

Technical data

Operating and environmental conditions		
Operating pressure	[bar]	0.6 ... 12
Operating pressure <sup>1)</sup>	[bar]	4 ... 8
Operating medium <sup>2)</sup>		Compressed air according to ISO 8573-1:2010 [6:4:4]
Note about the operating/pilot medium		Lubricated operation not possible Pressure dew point 10 °C below ambient/medium temperature
Ambient temperature <sup>3)</sup>	[°C]	-20 ... +80
Vibration resistance to DIN/IEC 68, Part 2-6		Severity level 2
Continuous shock resistance to DIN/IEC 68, Part 2-82		Severity level 2
CE marking (see declaration of conformity) <sup>4)</sup>		To EU EMC Directive
Corrosion resistance class CRC <sup>5)</sup>		1

- 1) Only applies to applications with end-position controller CPX-CMPX, SPC11 and axis controller CPX-CMAX
- 2) The proportional directional control valve VPWP, MPYE requires these characteristic values
- 3) Note operating range of proximity sensors
- 4) For information about the applicability of the component see the manufacturer's EC declaration of conformity at: [www.festo.com/sp](http://www.festo.com/sp) → User documentation.  
If the component is subject to restrictions on usage in residential, office or commercial environments or small businesses, further measures to reduce the emitted interference may be necessary.
- 5) Corrosion resistance class 1 according to Festo standard 940 070  
Components subject to low corrosion stress. Transport and storage protection. Parts that do not have primarily decorative surface requirements, e.g. in internal areas that are not visible or behind covers.

Forces [N] and impact energy [Nm]				
Piston Ø	32	40	50	63
Theoretical force at 6 bar, advancing	483	754	1178	1870
	S2 415	633	990	1682
Theoretical force at 6 bar, retracting	415	633	990	1682
	S2 415	633	990	1682
Impact energy in the end positions	0.1	0.2	0.2	0.5

Permissible impact velocity:

$$v_{perm.} = \sqrt{\frac{2 \times E_{perm.}}{m_{dead} + m_{load}}}$$

$v_{perm.}$  Permissible impact velocity  
 $E_{perm.}$  Max. impact energy  
 $m_{dead}$  Moving mass (drive)  
 $m_{load}$  Moving effective load

 Note  
 These specifications represent the maximum values that can be achieved. Note the maximum permissible impact energy.

Maximum permissible load:

$$m_{load} = \frac{2 \times E_{perm.}}{v^2} - m_{dead}$$

# Standard cylinders DNCl, with integrated displacement encoder

FESTO

Technical data

Positioning characteristics with axis controller CPX-CMAX					
Piston Ø		32	40	50	63
Stroke	[mm]	100 ... 750			
Mounting position		Any			
Resolution	[mm]	0.01			
Repetition accuracy	[mm]	≤ ±0.5			
Minimum load, horizontal	[kg]	3	5	8	12
Maximum load, horizontal	[kg]	45	75	120	180
Minimum load, vertical <sup>1)</sup>	[kg]	3	5	8	12
Maximum load, vertical <sup>1)</sup>	[kg]	15	25	40	60
Minimum travel speed	[m/s]	0.05			
Maximum travel speed	[m/s]	1.5			
Typical positioning time, long stroke <sup>2)</sup>	[s]	0.45/0.70	0.50/0.75	0.65/0.80	0.55/0.75
Typical positioning time, short stroke <sup>3)</sup>	[s]	0.35/0.55	0.40/0.55	0.45/0.60	0.40/0.55
Minimum positioning stroke <sup>4)</sup>	[%]	≤ 3			
Stroke reduction <sup>5)</sup>	[mm]	10		15	
Recommended proportional directional control valve					
For CPX-CMAX		→ 27			

- 1) Only in combination with an external guide
- 2) At 6 bar, horizontal mounting position, DNCl-XX-500, 400 mm travel at min./max. load
- 3) At 6 bar, horizontal mounting position, DNCl-XX-500, 100 mm travel at min./max. load
- 4) In relation to the maximum stroke of the drive, but never more than 20 mm
- 5) The stroke reduction must be maintained on each side of the drive, the max. positionable stroke is therefore: stroke – 2x stroke reduction

Force control characteristics with axis controller CPX-CMAX					
Piston Ø		32	40	50	63
Stroke	[mm]	100 ... 750			
Mounting position		Any			
Maximum controllable force <sup>1)</sup>	[N]	435/375	680/570	1060/890	1685/1515
Typical friction forces <sup>2)</sup>	[N]	30	40	70	70
Repetition accuracy of pressure control <sup>3)4)</sup>	[%]	< ±2			

- 1) Advancing/retracting at 6 bar
- 2) These values can fluctuate greatly from cylinder to cylinder and are not guaranteed.  
These friction forces must also be taken into consideration when using an external guide or when the cylinder is moving other components subject to friction
- 3) This value defines the repetition accuracy with which the internal differential pressure in the cylinder is controlled and refers to the maximum controllable force (the internal differential pressure corresponds to the prescribed force setpoint value)
- 4) The effective force at the workpiece and its accuracy depends largely on the friction in the system as well as the repetition accuracy of the internal control system. Note that friction forces always work against the direction of movement of the piston. The following formula can be used as a rule of thumb for the force F at the workpiece:  

$$F = F_{\text{setpoint}} \pm F_{\text{friction forces}} \pm \text{repetition accuracy of pressure control}$$

# Standard cylinders DNCI, with integrated displacement encoder

Technical data

Positioning characteristics with Soft Stop end-position controller CPX-CMPX, SPC11					
Piston $\varnothing$		32	40	50	63
Stroke	[mm]	100 ... 500			
Mounting position		Any			
Repetition accuracy <sup>1)</sup>	[mm]	$\pm 2$			
Minimum load, horizontal	[kg]	3	5	8	12
Maximum load, horizontal	[kg]	45	75	120	180
Minimum load, vertical <sup>2)</sup>	[kg]	3	5	8	12
Maximum load, vertical <sup>2)</sup>	[kg]	15	25	40	60
Travel time		→ Soft Stop sizing software: → <a href="http://www.festo.com">www.festo.com</a>			
Recommended proportional directional control valve					
For CPX-CMPX		→ 27			
For SPC11		→ 28			

- 1) One intermediate position. The accuracy in the end positions depends solely on the stability of the end stops  
 2) Only in combination with an external guide

Electrical data – Displacement encoder		
Output signal		Analogue
Linearity error		
Strokes up to 500 mm	[mm]	< $\pm 0.08$
Strokes up to 1,000 mm	[mm]	< $\pm 0.09$
Strokes above 1,000 mm	[mm]	< $\pm 0.11$
Maximum travel speed	[m/s]	1.5
Protection class		IP65
CE marking (see declaration of conformity)		To EU EMC Directive <sup>1)</sup>
Maximum permitted magnetic interference field <sup>2)</sup>	[kA/m]	10
Electrical connection		Cable with 8-pin plug, round type M12
Cable length	[m]	1.5

- 1) For information about the applicability of the component see the manufacturer's EC declaration of conformity at: [www.festo.com/sp](http://www.festo.com/sp) → User documentation.  
 If the component is subject to restrictions on usage in residential, office or commercial environments or small businesses, further measures to reduce the emitted interference may be necessary.  
 2) At a distance of 100 mm

## Pin allocation for plug

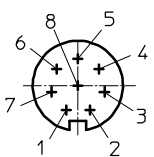

Pin	Function	Colour
1	5 V	Black
2	GND	Brown
3	sin+	Red
4	sin-	Orange
5	cos-	Green
6	cos+	Yellow
7	Screening	Screened
8	n.c.	-

# Standard cylinders DNCI, with integrated displacement encoder

Technical data

Weight [g]				
Piston Ø	32	40	50	63
DNCI-...				
Product weight with 0 mm stroke	521	853	1319	1914
Additional weight per 10 mm stroke	30	44	62	71
Moving load with 0 mm stroke	95	175	316	383
Additional weight per 10 mm stroke	8	14	23	23
DNCI-...-S2 – Through piston rod				
Product weight with 0 mm stroke	586	981	1553	2165
Additional weight per 10 mm stroke	39	60	87	96
Moving load with 0 mm stroke	155	164	297	364
Additional weight per 10 mm stroke	17	30	48	48
DNCI-...-K8 – Additional weight with piston rod extension				
Additional weight per 10 mm stroke	8	14	23	23
DNCI-...-KP – Additional weight with clamping unit				
Product weight	234	394	700	1147
DNCI-...-FENG – Additional weight with guide unit				
Product weight with 0 mm stroke	1530	2370	4030	5410
Additional weight per 10 mm stroke	18	32	50	62

## Materials

Sectional view

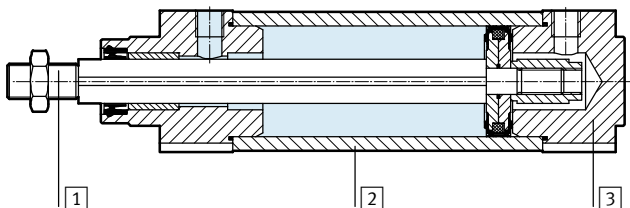

Standard cylinder	
1	Piston rod High-alloy steel
2	Cylinder barrel Anodised aluminium
3	Bearing/end caps Die-cast aluminium
-	Dynamic seals Polyurethane TPE-U
-	Static seals NBR
-	Note on materials RoHS-compliant
Displacement encoder	
-	Sensor housing Polyacetal
-	Cable sheath Polyurethane
-	Plug housing Polybutylene terephthalate
-	Mounting plate Polyacetal
-	Screws for mounting plate Steel



# Standard cylinders DNCI, with integrated displacement encoder

Technical data

## Torques and lateral forces

The piston rod must not absorb any torque. We therefore recommend that an external guide FENG-KF be used with the drive DNCI. The guide unit is supplied attached.

The permissible static and dynamic characteristic load values with and without attached guide as well as with regard to the technical data of the variants (S2, S8, S9)

→ Internet: dnc

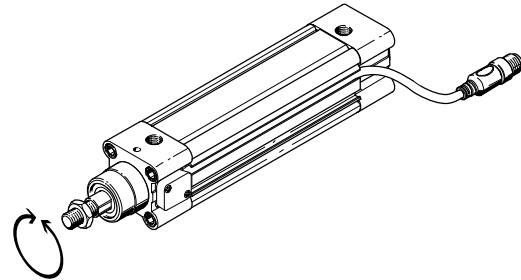

## Mounting conditions

When mounting a drive A with magnet (for position sensing) next to a standard cylinder DNCI, the following conditions must be observed:

- X Minimum distance between the drives
- Y Offset between the drives on the bearing cap

### Parallel assembly

If the offset  $Y = 0$  mm, the drives can be assembled directly next to one another.

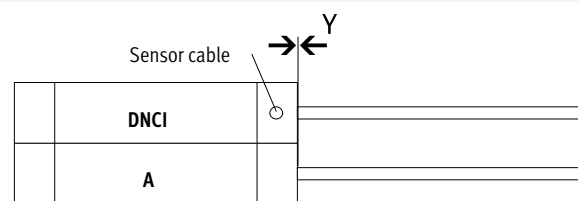

### Offset assembly, cable outlet between the drives

If the offset is  $Y > 0$  mm and the cable outlet is between the drives, a distance of  $X > 70$  mm must be observed.

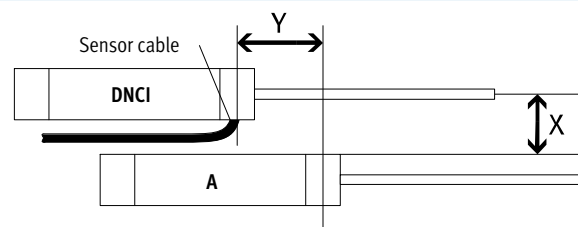

### Offset assembly, cable outlet upwards or downwards

If the offset is  $Y > 0$  mm and the cable outlet is up or down, a distance of  $X > 60$  mm must be observed.

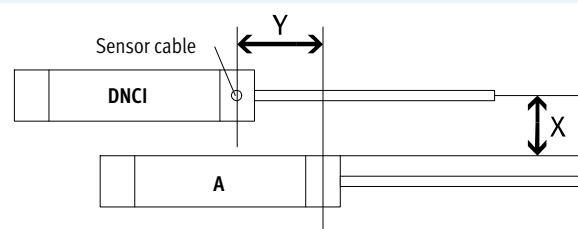

# Standard cylinders DNCI, with integrated displacement encoder

Technical data

FESTO

## Dimensions

Download CAD data → [www.festo.com](http://www.festo.com)

### Basic design

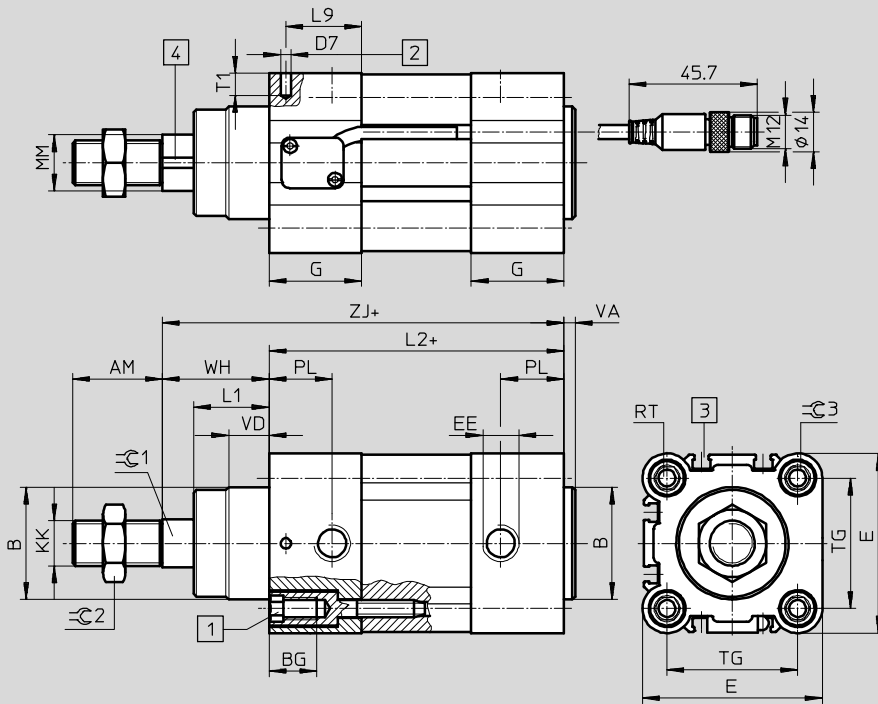

- 1 Socket head screw with female thread for mounting attachments
- 2 Hole for securing the earthing for self-tapping M4 screw according to DIN 7500
- 3 Sensor slot for proximity sensor SME/SMT-8
- 4 Magnetic measuring band

+ = plus stroke length  
++ = plus 2x stroke length

### S2 – Through piston rod

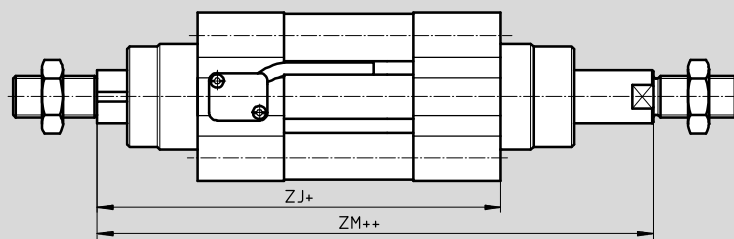

+ = plus stroke length  
++ = plus 2x stroke length

### S2/KP – Through piston rod with clamping unit

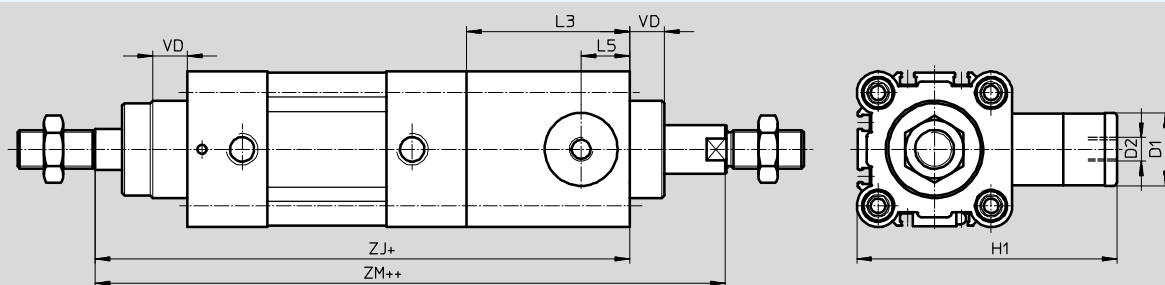

### K8 – Extended piston rod

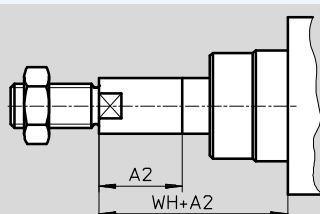

# Standard cylinders DNCI, with integrated displacement encoder

Technical data

∅ [mm]	AM	A2 max.	B ∅ d11	BG	D1 ∅ f9	D2	D7 ∅	E	EE	G	H1
32	22	500	30	16	20	M5	3.7	45	G <sup>1</sup> / <sub>8</sub>	28	67
40	24	500	35	16	24	G <sup>1</sup> / <sub>8</sub>	3.7	54	G <sup>1</sup> / <sub>4</sub>	33	88
50	32	500	40	17	30	G <sup>1</sup> / <sub>8</sub>	3.7	64	G <sup>1</sup> / <sub>4</sub>	33	107
63	32	500	45	17	38	G <sup>1</sup> / <sub>8</sub>	3.7	75	G <sup>3</sup> / <sub>8</sub>	40.5	123

∅ [mm]	KK	L1	L2	L3	L5	L9	MM ∅ f8	PL	RT	T1	TG
32	M10x1.25	18	94	45	14	22.5	12	15.6	M6	8	32.5
40	M12x1.25	21.3	105	53	16	27	16	14	M6	8	38
50	M16x1.5	26.8	106	67	20	27	20	14	M8	8	46.5
63	M16x1.5	27	121	76	24	33	20	17	M8	8	56.5

∅ [mm]	VA	VD	WH	ZJ		ZM		≈C1	≈C2	≈C3
					KP		KP			
32	4	10	26	120	165	148	193	10	16	6
40	4	10.8	30	135	188	167	220	13	18	6
50	4	14.3	37	143	210	183	250	17	24	8
63	4	14.5	37	158	234	199	275	17	24	8

# Standard cylinders DNCl, with integrated displacement encoder

Technical data

## Dimensions

Download CAD data → [www.festo.com](http://www.festo.com)

Guide unit FENG-KF

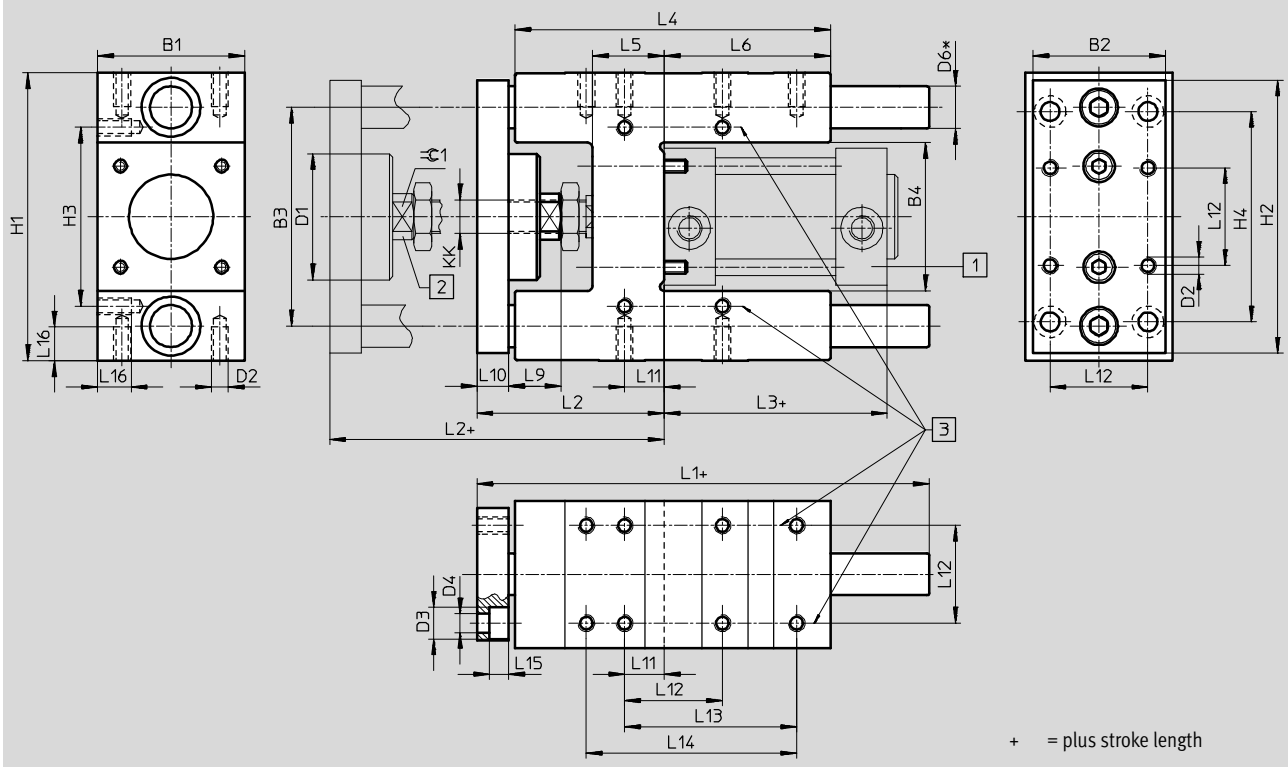

# Standard cylinders DNCl, with integrated displacement encoder

Technical data

For Ø	B1	B2	B3	B4	D1	D2	D3	D4	D6	H1
[mm]	-0.3		±0.2	±0.3	Ø		Ø	Ø	Ø h6	
32	50	45	74	50.5	44	M6	11	6.6	12	97 <sup>-0.4</sup>
40	58	54	87	58.5	44	M6	11	6.6	16	115 <sup>-0.4</sup>
50	70	63	104	70.5	60	M8	15	9	20	137 <sup>-0.5</sup>
63	85	80	119	85.5	60	M8	15	9	20	152 <sup>-0.5</sup>

For Ø	H2	H3	H4	KK	L1	L2	L3	L4	L5	L6
[mm]		±0.2	±0.2							
32	90	61	78	M10x1.25	155	67 <sup>+5</sup>	94	125	24	76
40	110	69	84	M12x1.25	170	75 <sup>+5</sup>	105	140	28	81
50	130	85	100	M16x1	188	89 <sup>+10</sup>	106	150	34	79
63	145	100	105	M16x1	220	89 <sup>+10</sup>	121	182	34	111

For Ø	L9	L10	L11	L12	L13	L14	L15	L16	⊕1
[mm]				±0.2	±0.2	±0.2			
32	20	12	4.3	32.5	70.3	78	6.5	12	15
40	22	12	11	38	84	–	6.5	14	15
50	25	15	18.8	46.5	81.8	100	9	16	19
63	25	15	15.3	56.5	105	–	9	16	19

# Standard cylinders DNCI, with integrated displacement encoder

Ordering data – Modular products

Ordering table							
Piston Ø	32	40	50	63	Condi- tions	Code	Enter code
<b>M</b> Module No.	<b>535411</b>	<b>535412</b>	<b>535413</b>	<b>535414</b>			
Function	Standard cylinder with integrated displacement encoder, non-rotating piston rod					<b>DNCI</b>	DNCI
Piston Ø [mm]	32	40	50	63		-...	
Stroke [mm]	10 ... 2000				<b>1</b>	-...	
Stroke [mm]	10 ... 2000					-...	
Cushioning	Elastic cushioning rings/pads at both ends					<b>-P</b>	-P
Position sensing	Via proximity sensor					<b>-A</b>	-A

**1** **Stroke** Can only be used without restriction as a positioning drive in the range from 100 ... 750 mm

Transfer order code

# Standard cylinders DNCI, with integrated displacement encoder

Ordering data – Modular products

Ordering table								
Piston Ø	32	40	50	63	Condi- tions	Code	Enter code	
0	Piston rod type				Through piston rod		-S2	
	Piston rod extended at [mm] front				1 ... 500	2	-...K8	
	Clamping unit				Attached	3	-KP	
	Guide				Guide unit with ball bearing guide on the sensor head side	4	-FENG	
	Measured-value transducer				Output 0 ... 10 V		-MU	
							-MI	
	Measuring head				No measuring head	5	-MS	

- 2 **K8** In combination with piston rod type S2, the piston rod is only extended at the front (slide closest to the measuring head)
- 3 **KP** Can only be combined with piston rod type S2
- 4 **FENG** Maximum stroke length 500 mm

 Note

5 The standard cylinder can be ordered without a measuring head for repairs (→ code MS). The existing measuring head can be installed in the new standard cylinder (→ operating instructions for DNCI).

Transfer order code

-  -  -  -  -  -

# Standard cylinders DNCl, with integrated displacement encoder



Accessories

## Foot mounting HNC

Material:  
Galvanised steel  
Free of copper and PTFE

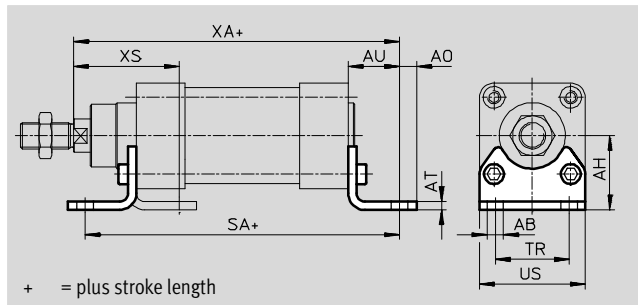

Dimensions and ordering data							
For $\varnothing$ [mm]	AB $\varnothing$	AH	AO	AT	AU	SA	
						Basic cylinder	KP
32	7	32	6.5	4	24	142	187
40	10	36	9	4	28	161	214
50	10	45	9.5	5	32	170	237
63	10	50	12.5	5	32	185	261

For $\varnothing$ [mm]	TR	US	XA		XS	CRC <sup>1)</sup>	Weight [g]	Part No.	Type
			Basic cylinder	KP					
32	32	45	144	189	45	2	144	<b>174369</b>	<b>HNC-32</b>
40	36	54	163	216	53	2	193	<b>174370</b>	<b>HNC-40</b>
50	45	64	175	242	62	2	353	<b>174371</b>	<b>HNC-50</b>
63	50	75	190	266	63	2	436	<b>174372</b>	<b>HNC-63</b>

1) Corrosion resistance class CRC 2 to Festo standard FN 940070  
Moderate corrosion stress. Indoor applications in which condensation may occur. External visible parts with primarily decorative requirements for the surface and which are in direct contact with the ambient atmosphere typical for industrial applications.



# Standard cylinders DNCI, with integrated displacement encoder

Accessories

## Flange mounting FNC

Material:  
 FNC: Galvanised steel  
 Free of copper and PTFE  
 RoHS-compliant

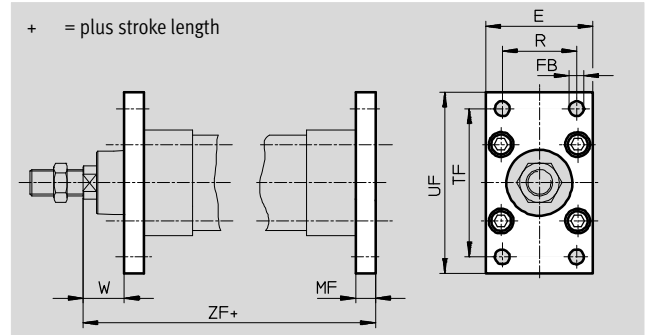

Dimensions and ordering data													
For Ø [mm]	E	FB Ø H13	MF	R	TF	UF	W	ZF		CRC <sup>1)</sup>	Weight [g]	Part No.	Type
								Basic cylinder	KP				
32	45	7	10	32	64	80	16	130	175	1	221	<b>174376</b>	<b>FNC-32</b>
40	54	9	10	36	72	90	20	145	198	1	291	<b>174377</b>	<b>FNC-40</b>
50	65	9	12	45	90	110	25	155	222	1	536	<b>174378</b>	<b>FNC-50</b>
63	75	9	12	50	100	120	25	170	246	1	679	<b>174379</b>	<b>FNC-63</b>

1) Corrosion resistance class CRC 1 to Festo standard FN 940070  
 Low corrosion stress. For dry indoor applications or transport and storage protection. Also applies to parts behind covers, in the non-visible interior area, and parts which are covered in the application (e.g. drive trunnions).

## Rod eye SGS

Scope of delivery:  
 1 rod eye, 1 hex nut to DIN 439

Material:  
 Galvanised steel  
 RoHS-compliant

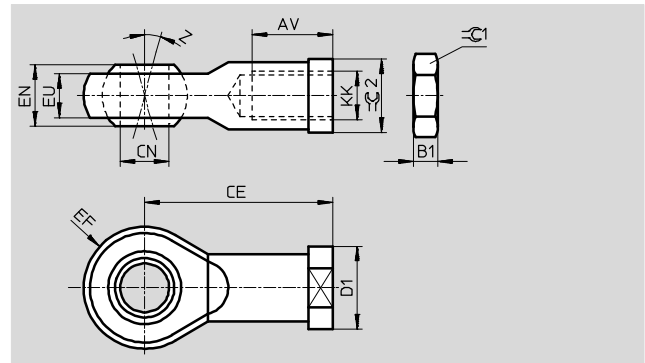

Dimensions and ordering data														
For Ø [mm]	AV	B1	CE	CN Ø H7	D1 Ø	EF ±0.5	EN	Z [°]	$\approx C1$	$\approx C2$	CRC <sup>1)</sup>	Weight [g]	Part No.	Type
M12x1.25	22 -2	6	50	12	22	16	16	13	19	19	2	105	<b>9262</b>	<b>SGS-M12x1,25</b>
M16x1.5	28 -2	8	64	16	27	21	21	15	24	22	2	210	<b>9263</b>	<b>SGS-M16x1,5</b>

1) Corrosion resistance class CRC 2 to Festo standard FN 940070  
 Moderate corrosion stress. Indoor applications in which condensation may occur. External visible parts with primarily decorative requirements for the surface and which are in direct contact with the ambient atmosphere typical for industrial applications.

# Standard cylinders DNCl, with integrated displacement encoder

Accessories



## Trunnion mounting kit DAMT

The mounting kit can be attached at any position along the profile barrel of the cylinder.

Material:  
Galvanised steel  
Free of copper and PTFE  
RoHS-compliant

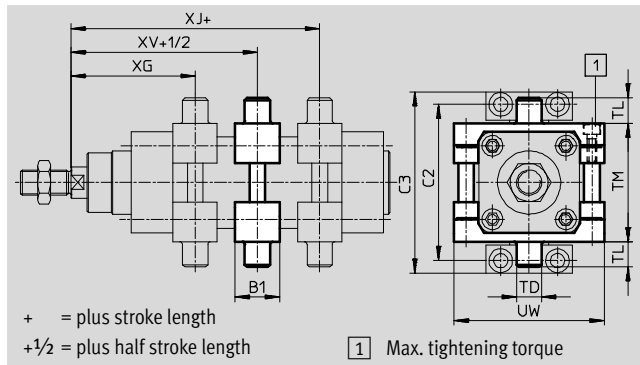

Dimensions and ordering data									
For Ø	B1	C2	C3	TD	TL	TM	UW	XG	
[mm]				Ø e9				Basic cylinder	KP
32	30	71	86	12	12	50	65	66.1	111.1
40	32	87	105	16	16	63	75	75.6	128.6
50	34	99	117	16	16	75	95	83.6	150.6
63	41	116	136	20	20	90	105	93.1	169.1

For Ø	XJ		XV		Max. tightening torque	CRC <sup>1)</sup>	Weight	Part No.	Type
	Basic cylinder	KP	Basic cylinder	KP					
[mm]					[Nm]		[g]		
32	79.9	124.9	73	118	4+1	1	213	2213233	DAMT-V1-32-A
40	89.4	142.4	82.5	135.5	8+1	1	388	2214899	DAMT-V1-40-A
50	96.4	163.4	90	157	8+2	1	608	2214909	DAMT-V1-50-A
63	101.9	177.9	97.5	173.5	18+2	1	911	2214971	DAMT-V1-63-A

1) Corrosion resistance class CRC 1 to Festo standard FN 940070  
Low corrosion stress. For dry indoor applications or transport and storage protection. Also applies to parts behind covers, in the non-visible interior area, and parts which are covered in the application (e.g. drive trunnions).

## Trunnion support LNZG

Materials:  
Trunnion support: Anodised aluminium  
Plain bearing: Plastic  
Free of copper and PTFE  
RoHS-compliant

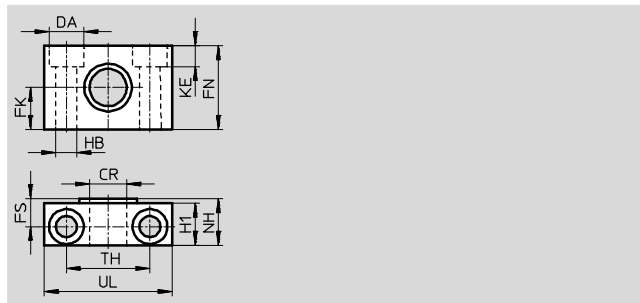
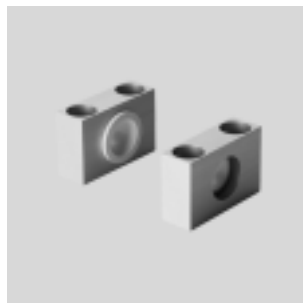

Dimensions and ordering data															
For Ø	CR	DA	FK	FN	FS	H1	HB	KE	NH	TH	UL	CRC <sup>1)</sup>	Weight	Part No.	Type
[mm]	Ø D11	Ø H13	±0.1				Ø H13			±0.2			[g]		
32	12	11	15	30	10.5	15	6.6	6.8	18	32	46	2	90	32959	LNZG-32
40, 50	16	15	18	36	12	18	9	9	21	36	55	2	140	32960	LNZG-40/50
63	20	18	20	40	13	20	11	11	23	42	65	2	190	32961	LNZG-63/80

1) Corrosion resistance class CRC 2 to Festo standard FN 940070  
Moderate corrosion stress. Indoor applications in which condensation may occur. External visible parts with primarily decorative requirements for the surface and which are in direct contact with the ambient atmosphere typical for industrial applications.

# Standard cylinders DNCI, with integrated displacement encoder

Accessories

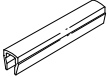
Ordering data					
	For Ø	Comment	Part No.	Type	PU <sup>1)</sup>
Slot cover					Technical data → Internet: abp
	32, 40, 50, 63	Every 0.5 m	151680	ABP-5-S	2

1) Packaging unit

 Note  
Recommended proximity sensor  
→ Internet: dnc

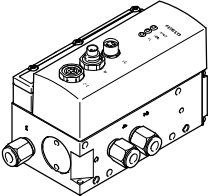
Ordering data – Proportional directional control valves and push-in fittings							
	For Ø [mm]	Stroke [mm]	Proportional directional control valve Technical data → Internet: vpwp		Push-in fitting for DNCI Technical data → Internet: quick star		PU <sup>1)</sup>
			Part No.	Type	Part No.	Type	
	For applications with axis controller CPX-CMAX						
	32	50 ... 150	550170	VPWP-4-L-5-Q6-10-E-...	186096	QS-G <sup>1</sup> / <sub>8</sub> -6	10
		151 ... 400	550170	VPWP-4-L-5-Q8-10-E-...	186098	QS-G <sup>1</sup> / <sub>8</sub> -8	
		> 401	550171	VPWP-6-L-5-Q8-10-E-...	186098	QS-G <sup>1</sup> / <sub>8</sub> -8	
	40	50 ... 250	550170	VPWP-4-L-5-Q8-10-E-...	186099	QS-G <sup>1</sup> / <sub>4</sub> -8	
		> 251	550171	VPWP-6-L-5-Q8-10-E-...	186099	QS-G <sup>1</sup> / <sub>4</sub> -8	
	50	50 ... 180	550170	VPWP-4-L-5-Q8-10-E-...	186099	QS-G <sup>1</sup> / <sub>4</sub> -8	
		181 ... 600	550171	VPWP-6-L-5-Q8-10-E-...	186099	QS-G <sup>1</sup> / <sub>4</sub> -8	
		> 601	550172	VPWP-8-L-5-Q10-10-E-...	186101	QS-G <sup>1</sup> / <sub>4</sub> -10	
	63	50 ... 100	550170	VPWP-4-L-5-Q8-10-E-...	186100	QS-G <sup>3</sup> / <sub>8</sub> -8	
101 ... 350		550171	VPWP-6-L-5-Q8-10-E-...	186102	QS-G <sup>3</sup> / <sub>8</sub> -10		
> 351		550172	VPWP-8-L-5-Q10-10-E-...	186102	QS-G <sup>3</sup> / <sub>8</sub> -10		

1) Packaging unit

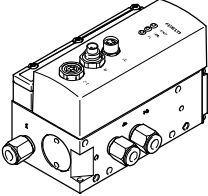
Ordering data – Proportional directional control valves and push-in fittings							
	For Ø [mm]	Stroke <sup>1)</sup> [mm]	Proportional directional control valve Technical data → Internet: vpwp		Push-in fitting for DNCI Technical data → Internet: quick star		PU <sup>2)</sup>
			Part No.	Type	Part No.	Type	
	For applications with Soft Stop end-position controller CPX-CMPX, horizontal						
	32	100 ... 400	550170	VPWP-4-L-5-Q8-10-E-...	186098	QS-G <sup>1</sup> / <sub>8</sub> -8	10
		401 ... 500	550171	VPWP-6-L-5-Q8-10-E-...	186098	QS-G <sup>1</sup> / <sub>8</sub> -8	
	40	100 ... 250	550170	VPWP-4-L-5-Q8-10-E-...	186099	QS-G <sup>1</sup> / <sub>4</sub> -8	
		251 ... 500	550171	VPWP-6-L-5-Q8-10-E-...	186099	QS-G <sup>1</sup> / <sub>4</sub> -8	
	50	100 ... 250	550170	VPWP-4-L-5-Q8-10-E-...	186099	QS-G <sup>1</sup> / <sub>4</sub> -8	
		251 ... 400	550171	VPWP-6-L-5-Q8-10-E-...	186099	QS-G <sup>1</sup> / <sub>4</sub> -8	
		500	550172	VPWP-8-L-5-Q10-10-E-...	186101	QS-G <sup>1</sup> / <sub>4</sub> -10	
	63	100 ... 160	550170	VPWP-4-L-5-Q8-10-E-...	186100	QS-G <sup>3</sup> / <sub>8</sub> -8	
		161 ... 320	550171	VPWP-6-L-5-Q8-10-E-...	186100	QS-G <sup>3</sup> / <sub>8</sub> -8	
321 ... 500		550172	VPWP-8-L-5-Q10-10-E-...	186102	QS-G <sup>3</sup> / <sub>8</sub> -10		

1) Other stroke lengths on request

2) Packaging unit

# Standard cylinders DNCI, with integrated displacement encoder

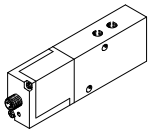

Accessories

Ordering data – Proportional directional control valves and push-in fittings							
	For Ø	Stroke <sup>1)</sup>	Proportional directional control valve		Push-in fitting for DNCI		
	[mm]	[mm]	Technical data → Internet: mpye		Technical data → Internet: quick star		
			Part No.	Type	Part No.	Type	PU <sup>2)</sup>
	For applications with Soft Stop end-position controller SPC11, horizontal						
	32	100 ... 400	151692	MPYE-5-1/8-LF-010-B	186098	QS-G1/8-8	10
		401 ... 500	151693	MPYE-5-1/8-HF-010-B	186098	QS-G1/8-8	
	40	100 ... 250	151692	MPYE-5-1/8-LF-010-B	186099	QS-G1/4-8	
		251 ... 500	151693	MPYE-5-1/8-HF-010-B	186099	QS-G1/4-8	
	50	100 ... 250	151692	MPYE-5-1/8-LF-010-B	186099	QS-G1/4-8	
		251 ... 400	151693	MPYE-5-1/8-HF-010-B	186099	QS-G1/4-8	
		500	151694	MPYE-5-1/4-010-B	186101	QS-G1/4-10	
	63	100 ... 160	151692	MPYE-5-1/8-LF-010-B	186100	QS-G3/8-8	
		161 ... 320	151693	MPYE-5-1/8-HF-010-B	186100	QS-G3/8-8	
		321 ... 500	151694	MPYE-5-1/4-010-B	186102	QS-G3/8-10	

1) Other stroke lengths on request

2) Packaging unit