

Electric cylinders DNCE, with spindle drive



Electric cylinders DNCE, with spindle drive

Key features

At a glance

General

The electric cylinder DNCE is a mechanical linear axis with piston rod. The drive component consists of an electrically driven spindle, which converts the rotary motion of the motor into the

linear motion of the piston rod. The mechanical interfaces are largely compatible with the standard cylinder DNC.

Properties

- Choice of spindle type:
 - With lead screw (LS)
 - With ball screw (BS)
- Electric cylinder with lead screw spindle is self-retarding
- Compact dimensions
- Optional:
 - Protection class IP65
 - High corrosion protection
 - NSF-H1 lubricant for the food industry

Range of applications

- Lead screw spindle
 - For applications with slow feed speeds
- Ball screw spindle
 - For applications with high feed speeds and high running performance



Note

The electric cylinder is of limited suitability for the food industry.

Further information www.festo.com/sp → User documentation.

Entire system consisting of electric cylinder, motor and motor mounting kit

Electric cylinder

→ 6

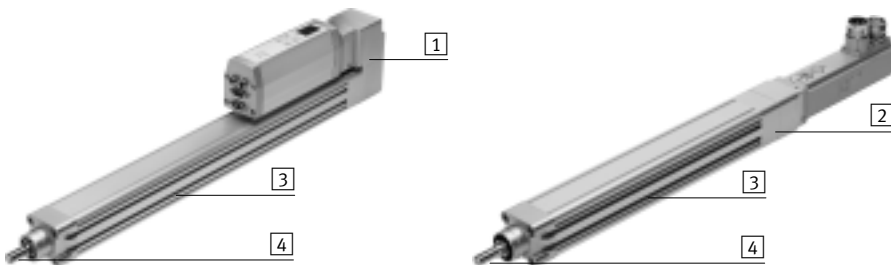

- 1 Parallel kit
- 2 Axial kit
- 3 Slot for proximity sensor
- 4 Choice of spindle type:
 - With lead screw spindle (LS)
 - With ball screw spindle (BS)



Note

The lead screw spindle is self-retarding, which means that slow movements cannot be excluded in the event of vibration. The entire system with intelligent motor unit MTR-DCI is self-locking.

Motor/motor unit

→ 18



- 1 Motor unit MTR-DCI
- 2 Servo motor EMME-AS, EMMS-AS
- 3 Stepper motor EMMS-ST



Note

A range of specially adapted complete solutions is available for the electric cylinder DNCE and the motors/motor units.

Motor mounting kit

→ 18

Axial kit

Parallel kit



A range of complete kits is available for both parallel and axial motor mounting.

Electric cylinders DNCE, with spindle drive

Key features and type codes

Longer service life with bellows kit EADB

→ 27



The protective bellows kit is a leak-free system. To prevent unwanted media from being drawn in, the supply and exhaust air must be ducted via a pressure compensation hole in the connection part **1**.

The kit protects the piston rod, seal and bearings against a wide variety of media, for example:

- Dust
- Chippings
- Oil
- Grease
- Fuel

Use in dusty or wet environments thanks to protection to IP65 (feature P5)

→ 17

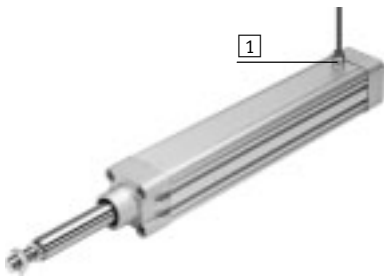

The electric cylinder to IP65 fulfills the specifications to IEC 60 529.

Air is exchanged between the interior of the cylinder and the environment via a pressure compensation hole **1** in the cylinder barrel. This prevents negative pressure or excess pressure in the interior of the cylinder.

It also prevents unwanted media being drawn in.

Protection to IP65 can only be selected in combination with DNCE-...-BS (ball screw spindle).

Type codes

DNCE – 32 – 100 – BS – "10"P – Q-P5

Type	
DNCE	Electric cylinder

Size	

Stroke [mm]	

Drive function	
LS	Lead screw spindle
BS	Ball screw spindle

Spindle pitch [mm]	

Variant	
Q	Non-rotating piston rod
K8	Extended piston rod
K3	Female piston rod thread
P5	Protection class IP65
R3	High corrosion protection
FG	Lubrication approved for use in food applications

Electric cylinders DNCE, with spindle drive

Peripherals overview

FESTO

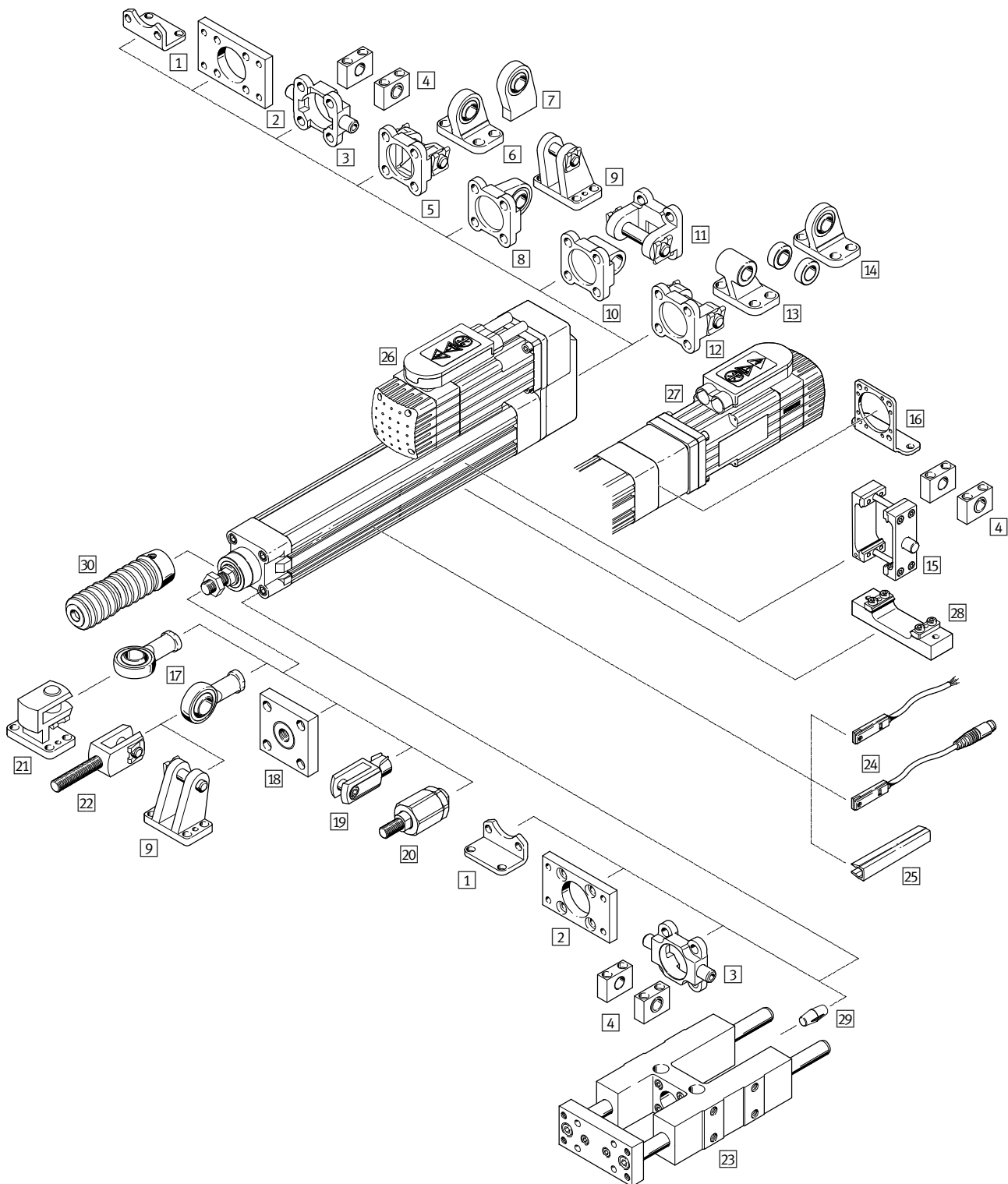

Mounting attachments and accessories		
	Description	→ Page/Internet
1	Foot mounting HNC/CRHNC For mounting the cylinder	32
2	Flange mounting FNC/CRFNG – Cannot be used on the bearing cap in combination with bellows kit EADB	33
3	Trunnion flange ZNCF/CRZNG – Cannot be used on the bearing cap in combination with bellows kit EADB	34

Electric cylinders DNCE, with spindle drive

Peripherals overview



Mounting attachments and accessories		
	Description	→ Page/Internet
4	Trunnion support LNZG/CRLNZG	For cylinders with trunnion mounting 35
5	Swivel flange SNC	With parallel motor mounting 36
6	Clevis foot LSNG	With parallel motor mounting, with spherical bearing 39
7	Clevis foot LSNSG	With parallel motor mounting, weld-on, with spherical bearing 39
8	Swivel flange SNCS	With parallel motor mounting, with spherical bearing 36
9	Clevis foot LBG	With parallel motor mounting, with spherical bearing 39
10	Swivel flange SNCL	With parallel motor mounting 37
11	Swivel flange SNCB/SNCB-...-R3	With parallel motor mounting, with spherical bearing 38
12	Swivel flange SNCB/SNCB-...-R3	With parallel motor mounting 38
13	Clevis foot LNG/CRLNG	With parallel motor mounting 39
14	Clevis foot LSN	With parallel motor mounting, with spherical bearing 39
15	Trunnion mounting kit DAMT	For mounting anywhere along the cylinder profile barrel. Cannot be mounted in the vicinity of the motor with parallel motor mounting 39
16	Foot mounting HNCE	– With axial motor mounting – Cannot be used in combination with the axial kit EAMM-A-...-S1 (protection class IP65) 30
17	Rod eye SGS/CRSGS	With spherical bearing 40
18	Coupling piece KSZ	To compensate for radial deviations 40
19	Rod clevis SG/CRSG	Permits a swivelling movement of the cylinder in one plane 40
20	Self-aligning rod coupler FK/CRFK	For compensating radial and angular deviations 40
21	Right-angle clevis foot LQG	For rod eye SGS 40
22	Rod clevis SGA	For swivel mounting of cylinders 40
23	Guide unit FENG	– For protecting electric cylinders against rotation at high torque loads – Cannot be used in combination with bellows kit EADB 40
24	Proximity sensor SME/SMT-8	For position sensing. Can be integrated in the sensor slot, thus avoiding projecting parts 41
25	Slot cover ABP-5-S	For protecting against the ingress of dirt 41
26	Parallel kit EAMM-U	For parallel motor mounting 18
27	Axial kit EAMM-A	For axial motor mounting 18
28	Profile mounting EAHF	– For mounting the electric cylinder via the profile – Cannot be mounted in the vicinity of the motor in combination with the parallel kit EAMM-U 31
29	Compensating element EADC	Compensates the play between the piston rod of the electric cylinder DNCE and the yoke plate of the guide unit FENG 41
30	Bellows kit EADB	– Protects the cylinder (piston rod, seal and bearings) against a wide range of media and thus prevents premature wear – The kit can only be used in combination with an extended piston rod (K8) 27

Electric cylinders DNCE, with spindle drive

Technical data

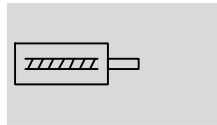
Function



-  - Size
32 ... 63
-  - Stroke length
1 ... 800 mm
-  - www.festo.com

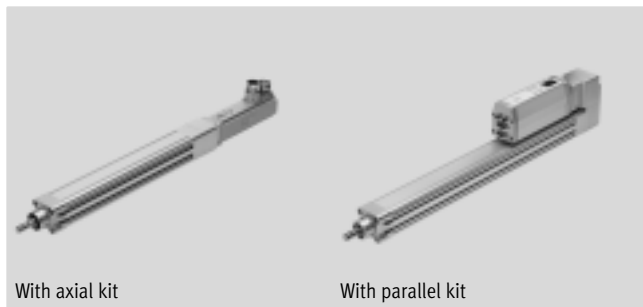

General technical data		32		40		63	
Design		With lead screw spindle (LS)		With lead screw spindle (LS)		With lead screw spindle (LS)	
		With ball screw spindle (BS)		With ball screw spindle (BS)		With ball screw spindle (BS)	
Piston rod thread							
Male thread		M10x1.25		M12x1.25		M16x1.5	
Female thread		M6		M8		M10	
Working stroke	[mm]	1 ... 400		1 ... 600		1 ... 800	
Variant		Non-rotating piston rod					
Protection against rotation/guide		Plain-bearing guide					
Stroke reserve	[mm]	0					
Max. torsion angle of the piston rod	[°]	±0.30		±0.25		±0.20	
Impact energy (E) in the end positions	[J]	0.0001 $E = 0.5 \times m \times v^2$		0.0002 $E = 0.5 \times m \times v^2$		0.0004 $E = 0.5 \times m \times v^2$	
Duty cycle ¹⁾	[%]	100					
Position sensing		Via proximity sensor					
Type of mounting		Via female thread					
		Via accessories					
Mounting position		Any					

1) In the case of the variant with lead screw spindle (LS), the duty cycle depends on the speed

Mechanical data		32			40			63		
Spindle design		LS-"1,5"P	BS-"3"P	BS-"10"P	LS-"2,5"P	BS-"5"P	BS-"12,7"P	LS-"4"P	BS-"10"P	BS-"20"P
Spindle pitch	[mm/rev.]	1.5	3	10	2.5	5	12.7	4	10	20
Spindle diameter	[mm]	9	10	10	12.5	12	12.7	20	20	20
Max. stat. axial force	[N]	600	600	600	1400	1400	1400	3700	3700	3700
Max. feed force $F_x^{1)}$	[N]	300	300	350	600	525	800	1000	2500	1625
Continuous feed force ¹⁾	[N]	300	240	280	600	420	640	1000	2000	1300
Max. driving torque ²⁾	[Nm]	0.4	0.4	0.8	1.15	0.9	1.9	3	4.9	5.9
Max. radial force ³⁾	[N]	120	120	120	260	260	260	300	300	300
Max. speed	[m/s]	0.06	0.15	0.5	0.07	0.25	0.64	0.07	0.5	1.0
Max. rotational speed	[rpm]	2400	3000	3000	1650	3000	3000	1050	3000	3000
Max. acceleration	[m/s ²]	1	6	6	1	6	6	1	6	6
Reversing backlash ⁴⁾	[mm]	0.2	0.05	0.05	0.2	0.05	0.05	0.2	0.05	0.05
Repetition accuracy	[mm]	±0.07	±0.02	±0.02	±0.07	±0.02	±0.02	±0.07	±0.02	±0.02

1) In the case of the variant with lead screw spindle (LS), the feed force depends on the speed → 10
The feed force in the case of the variant with ball screw spindle (BS) → 8

2) In the case of the variant with lead screw spindle (LS), the driving torque depends on the rotational speed → 11

3) At the drive shaft

4) In new condition

Electric cylinders DNCE, with spindle drive

Technical data

Mechanical data										
Size	32			40			63			
Spindle design	LS-™1,5™P	BS-™3™P	BS-™10™P	LS-™2,5™P	BS-™5™P	BS-™12,7™P	LS-™4™P	BS-™10™P	BS-™20™P	
No-load driving torque										
With axial kit ¹⁾										
DNCE-...	[Nm]	0.08	0.08	0.08	0.12	0.12	0.12	0.3	0.2	0.2
DNCE-...-P5	[Nm]	-	0.12	0.12	-	0.18	0.18	-	0.3	0.3
With parallel kit ¹⁾										
DNCE-...	[Nm]	0.13	0.13	0.13	0.22	0.22	0.22	0.6	0.5	0.5
DNCE-...-P5	[Nm]	-	0.17	0.17	0.17	0.28	0.28	-	0.6	0.6
Continuous driving torque	[Nm]	0.4	0.3	0.6	1.15	0.8	1.6	3	4.1	4.8

1) Measured at a speed of 200 rpm

Operating and environmental conditions	
Ambient temperature ¹⁾	[°C] 0 ... 50
Storage temperature	[°C] -25 ... +60
Protection class to IEC 60529	
DNCE-...	IP40
DNCE-...-P5	IP65
Relative air humidity	[%] 0 ... 95
Suitability for use in the food industry ²⁾	As per manufacturer's declaration
Corrosion resistance class CRC ³⁾	
DNCE-...-R3	3

1) Note operating range of proximity sensors and motors

2) Additional information www.festo.com/sp → User documentation.

3) Corrosion resistance class CRC 3 to Festo standard FN 940070

High corrosion stress. Outdoor exposure under moderate corrosive conditions. External visible parts with primarily functional requirements for the surface and which are in direct contact with a normal industrial environment.

Weight [g]										
Size	32			40			63			
Spindle design	LS-™1,5™P	BS-™3™P	BS-™10™P	LS-™2,5™P	BS-™5™P	BS-™12,7™P	LS-™4™P	BS-™10™P	BS-™20™P	
Basic weight with 0 mm stroke	720	750	770	1210	1270	1350	2790	3010	3010	
Additional weight per 10 mm stroke	32.4	33	33.6	46.1	45.5	46.7	79.8	81.2	81.2	
Moving load with 0 mm stroke	150	170	200	250	310	380	600	810	810	
Moving load per 10 mm stroke	6.9	6.9	6.9	8.9	8.9	8.9	12.8	12.8	12.8	

Mass moment of inertia										
Size	32			40			63			
Spindle design	LS-™1,5™P	BS-™3™P	BS-™10™P	LS-™2,5™P	BS-™5™P	BS-™12,7™P	LS-™4™P	BS-™10™P	BS-™20™P	
J ₀ with 0 mm stroke	[kg cm ²]	0.0433	0.0439	0.0446	0.1316	0.1304	0.1337	0.7565	0.7626	0.7624
j _H per metre stroke	[kg cm ² /m]	0.0361	0.0476	0.0595	0.1341	0.1163	0.1572	0.8176	0.9090	0.9103
j _L per kg working load	[kg cm ² /kg]	0.0006	0,0023	0.0253	0.0016	0.0063	0.0409	0.0041	0.0253	0.1013

The mass moment of inertia J_A of the electric cylinder is calculated as follows:

$$J_A = J_0 + j_H \times \text{working stroke [m]} + j_L \times m_{\text{working load [kg]}}$$

Electric cylinders DNCE, with spindle drive

Technical data



Calculation of the mean feed force F_{xm} for the electric cylinder DNCE with ball screw spindle (BS)

The peak feed force value must not exceed the maximum feed force within a movement cycle. In the case of vertical operation, the peak value is generally

achieved during the acceleration phase of the upwards stroke. If the maximum feed force is exceeded, this can increase wear and thus shorten

the service life of the ball screw spindle. The maximum speed must likewise not be exceeded.

$$F_x \leq F_{x\max.}$$

and

$$v_x \leq v_{x\max.}$$

Mean feed force (to DIN 69 051-4)

During operation, the continuous feed force may be briefly exceeded up to

the maximum feed force. The continuous feed force must, however,

be adhered to when averaged over a movement cycle.

$$F_{xm} \leq F_{x\text{cont}}$$

$$F_{xm} = \sqrt[3]{\sum F_x^3 \times \frac{v_x}{v_{xm}} \times \frac{q}{100}} =$$

$$F_{xm} = \sqrt[3]{F_{x1}^3 \times \frac{v_{x1}}{v_{xm}} \times \frac{q_1}{100} + F_{x2}^3 \times \frac{v_{x2}}{v_{xm}} \times \frac{q_2}{100} + F_{x3}^3 \times \frac{v_{x3}}{v_{xm}} \times \frac{q_3}{100} + \dots}$$

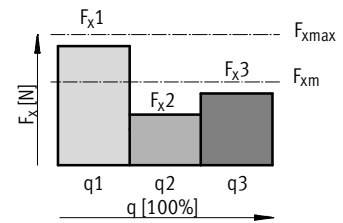

Mean feed speed (to DIN 69 051-4)

$$v_{xm} = \sum v_x \times \frac{q}{100} = v_{x1} \times \frac{q_1}{100} + v_{x2} \times \frac{q_2}{100} + v_{x3} \times \frac{q_3}{100} + \dots$$

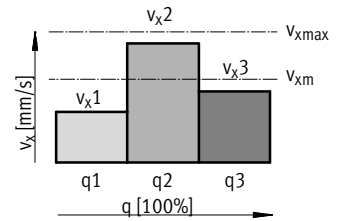

F_x	Feed force	v_x	Feed speed
F_{xm}	Mean feed force	v_{xm}	Mean feed speed
$F_{x\max.}$	Max. feed force	$v_{x\max.}$	Max. feed speed
$F_{x\text{cont}}$	Continuous feed force		
q	Time		

Materials

Sectional view

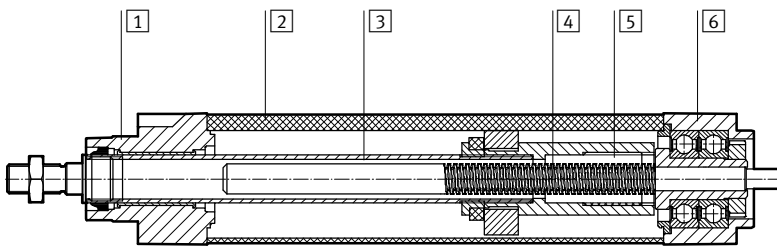

Electric cylinder	
1	Bearing cap Painted die-cast aluminium
2	Cylinder barrel Smooth anodised wrought aluminium alloy
3	Piston rod High-alloy stainless steel
4	Spindle Steel
5	Spindle nut for LS Polyacetal
	Spindle nut for BS Steel
6	Drive cover Painted die-cast aluminium
-	Note on materials RoHS-compliant Contains PWIS (paint-wetting impairment substances)

Electric cylinders DNCE, with spindle drive

Technical data

Maximum permissible loads on the piston rod

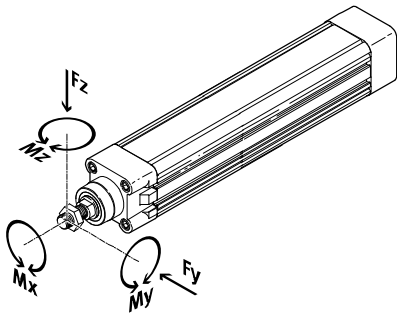

If there are two or more forces and torques simultaneously acting on the piston rod, the following equations must be satisfied:

$$\frac{|F_y|}{F_{y_{max}}} + \frac{|F_z|}{F_{z_{max}}} + \frac{|M_y|}{M_{y_{max}}} + \frac{|M_z|}{M_{z_{max}}} \leq 1$$

$$|F_x| \leq F_{x_{max}}$$

$$|M_x| \leq M_{x_{max}}$$

Definition of the stroke length l:
 l = Stroke + value of the piston rod extension K8

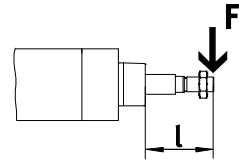

Maximum permissible lateral forces $F_{y_{max}}$ and $F_{z_{max}}$ on the piston rod as a function of stroke length l

Horizontal mounting position

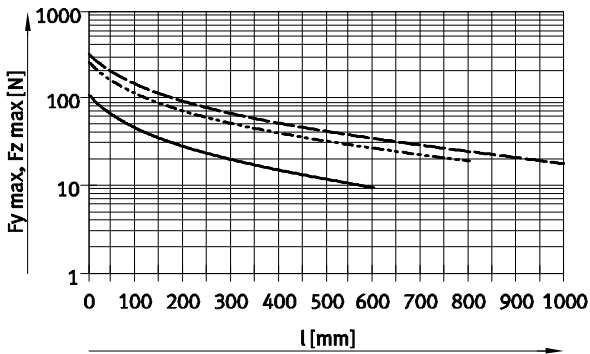

Vertical mounting position

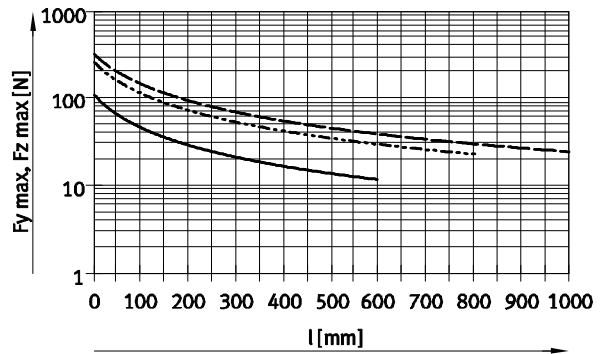

- DNCE-32-LS/BS
- - - DNCE-40-LS/BS
- · - DNCE-63-LS/BS

Note
 PositioningDrives
 sizing software
www.festo.com

Size	32	40	63
Maximum permissible forces and torques			
$F_{x_{max}}$ (static) [N]	600	1400	3700
$M_{x_{max}}$ [Nm]	1	1	1.5
$M_{y_{max}}, M_{z_{max}}$ [Nm]	8	20	27

Electric cylinders DNCE, with spindle drive

Technical data



Feed force F as a function of speed v

DNCE-32-1...299-LS-...

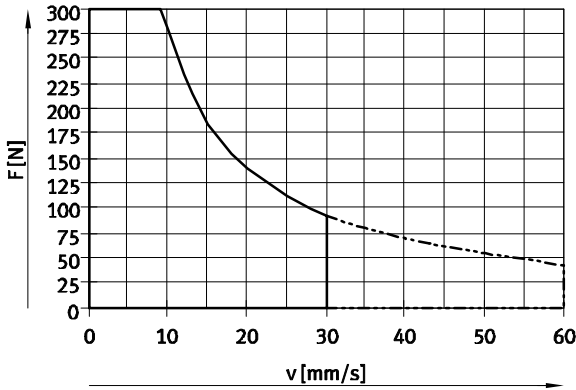

DNCE-32-300...400-LS-...

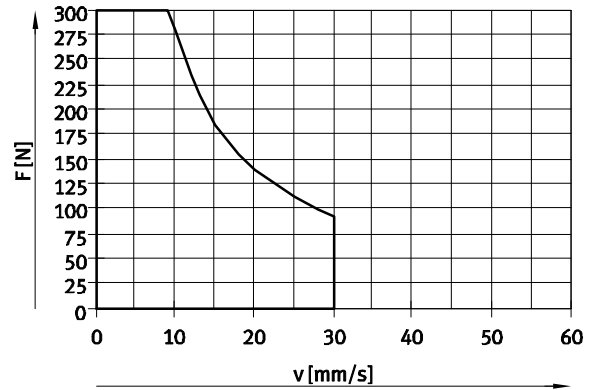

DNCE-40-1...299-LS-...

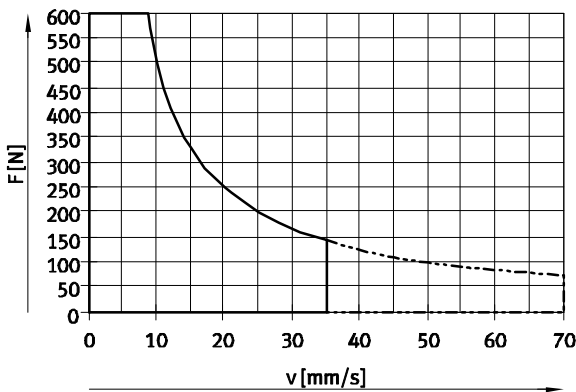

DNCE-40-300...600-LS-...

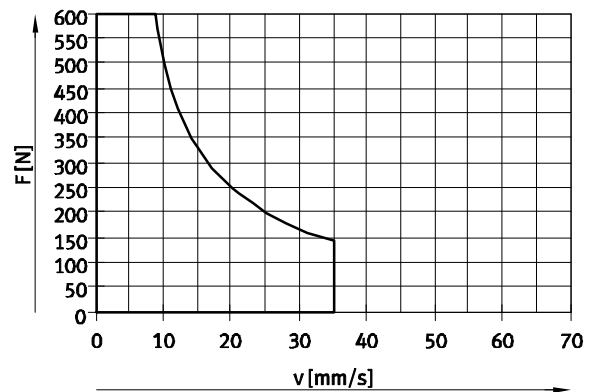

DNCE-63-1...419-LS-...

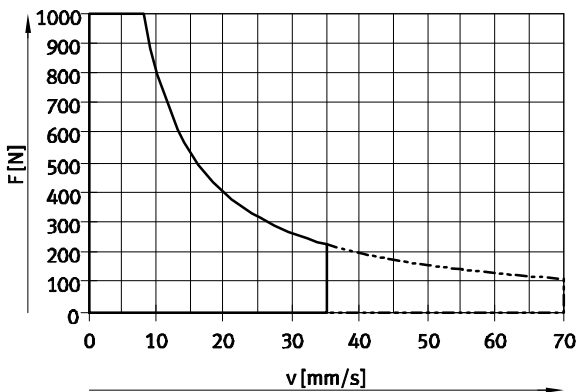

DNCE-63-420...800-LS-...

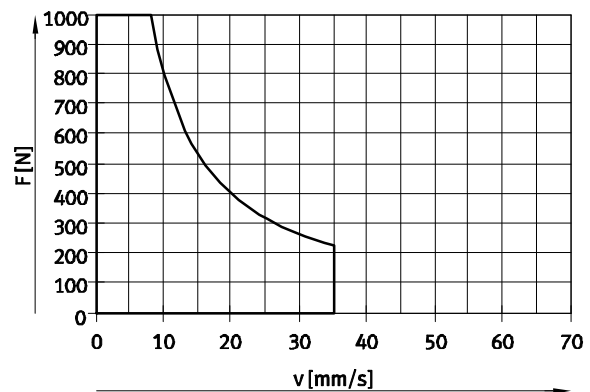

- Recommended operating range
- - - Permissible operating range
(duty cycle < 50% recommended)

Electric cylinders DNCE, with spindle drive

Technical data

Driving torque M as a function of rotational speed n

DNCE-32-1...299-LS-...

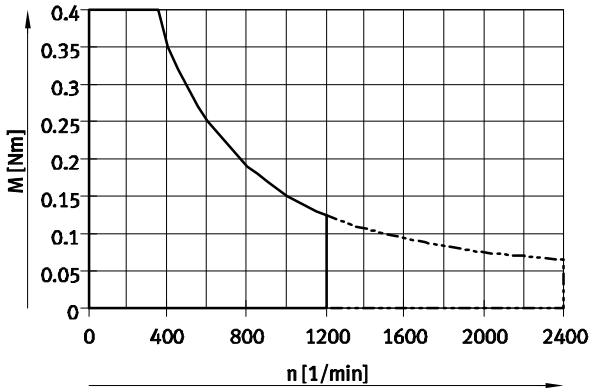

DNCE-32-300...400-LS-...

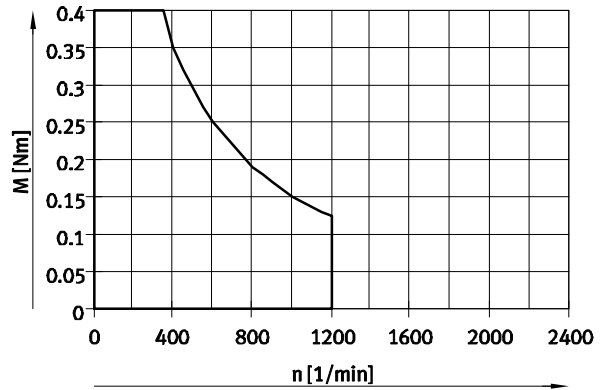

DNCE-40-1...299-LS-...

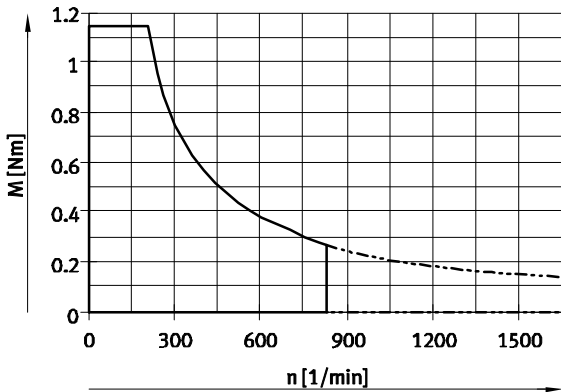

DNCE-40-300...600-LS-...

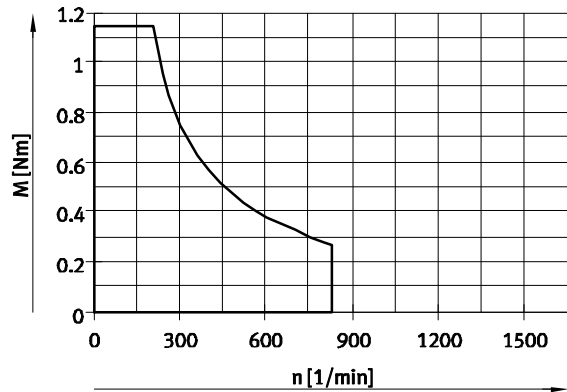

DNCE-63-1...419-LS-...

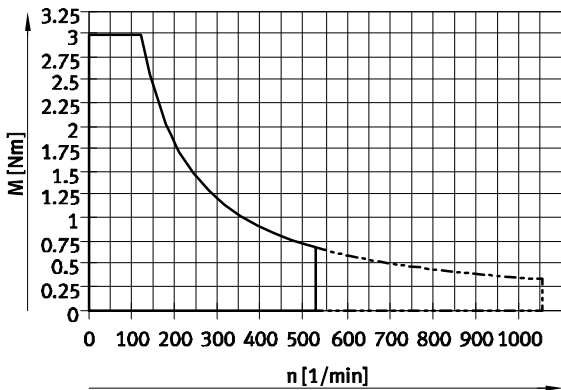

DNCE-63-420...800-LS-...

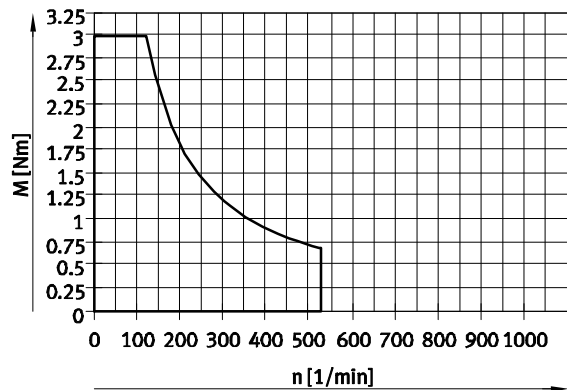

- Recommended operating range
- - - Permissible operating range
(duty cycle < 50% recommended)

Electric cylinders DNCE, with spindle drive

Technical data

Rotational speed n as a function of speed v

DNCE-...-LS-...

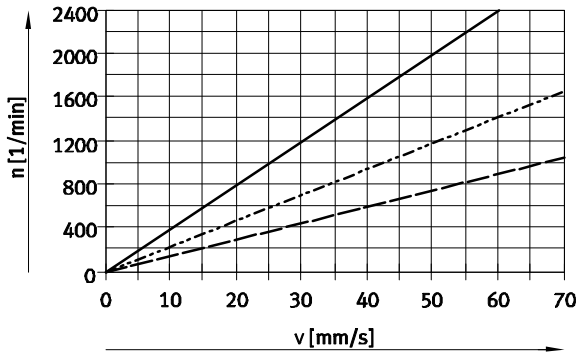

- DNCE-32-LS-1,5°P
- - - DNCE-40-LS-2,5°P
- · - DNCE-63-LS-4°P

DNCE-...-BS-...

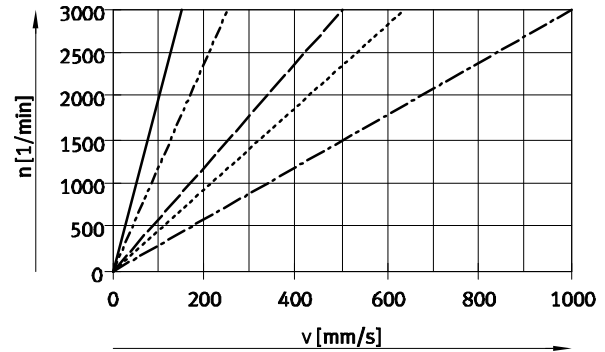

- DNCE-32-BS-3°P
- - - DNCE-40-BS-5°P
- · - DNCE-63-BS-10°P
- - - DNCE-32-BS-10°P
- · - DNCE-40-BS-12,7°P
- · - DNCE-63-BS-20°P

Driving torque M as a function of feed force F



Note

The frictional torques at room temperature are taken into consideration in the graphs.

The frictional torques with the DNCE-...-LS (lead screw spindle) increase at lower temperatures.

PositioningDrives sizing software
[→ www.festo.com](http://www.festo.com)

DNCE-...-LS-...

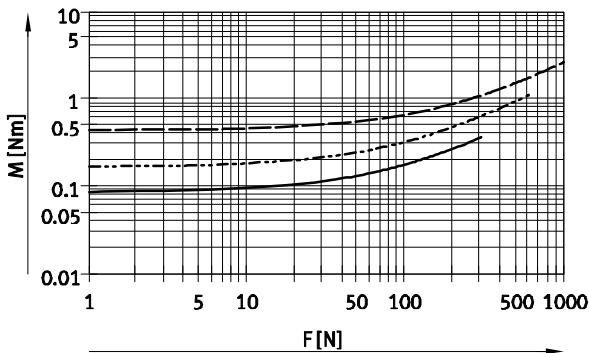

- DNCE-32-LS-1,5°P
- - - DNCE-40-LS-2,5°P
- · - DNCE-63-LS-4°P

DNCE-...-BS-...

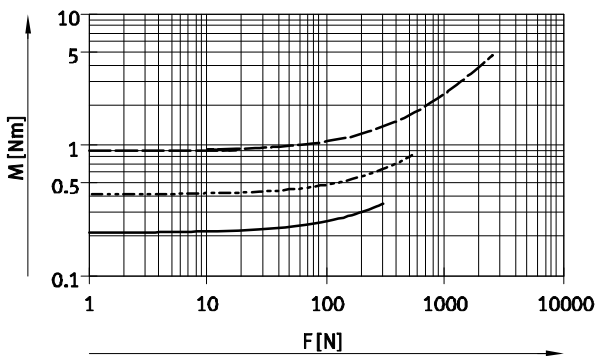

- DNCE-32-BS-3°P
- - - DNCE-40-BS-5°P
- · - DNCE-63-BS-10°P

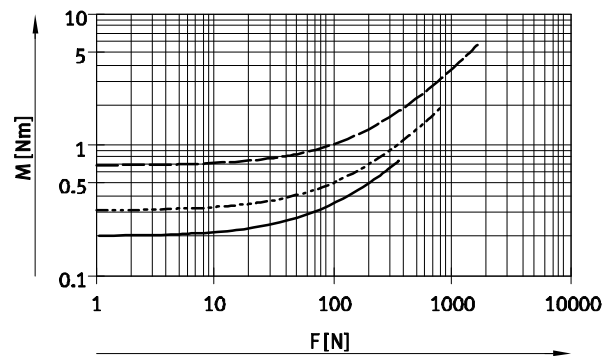

- DNCE-32-BS-10°P
- - - DNCE-40-BS-12,7°P
- · - DNCE-63-BS-20°P

Electric cylinders DNCE, with spindle drive

Technical data

Piston rod displacement f as a function of stroke length l

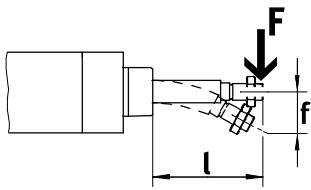

Definition of the stroke length l :
 $l = \text{Stroke} + \text{value of the piston rod extension K8}$

DNCE-32-...

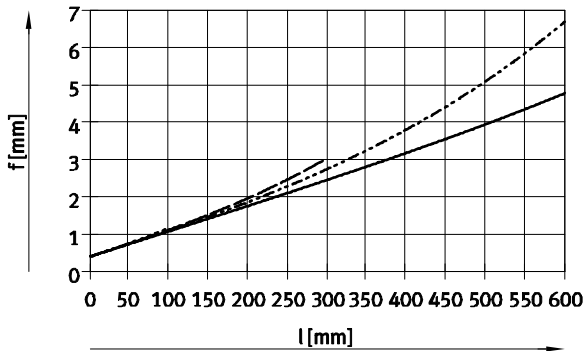

- Lateral force $F = 0$ N
- - - Lateral force $F = 10$ N
- · - Lateral force $F = 20$ N
- · · - Lateral force $F = 45$ N

DNCE-40-...

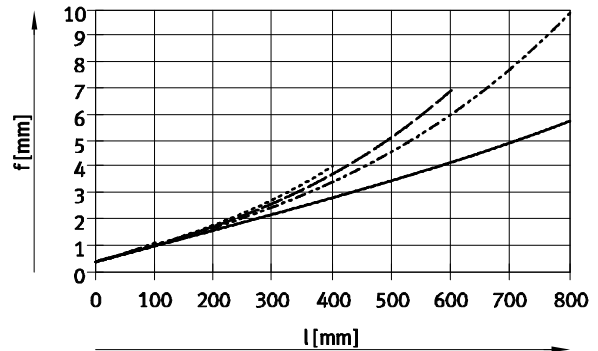

- Lateral force $F = 0$ N
- - - Lateral force $F = 20$ N
- · - Lateral force $F = 30$ N
- · · - Lateral force $F = 40$ N
- · · - Lateral force $F = 115$ N

DNCE-63-...

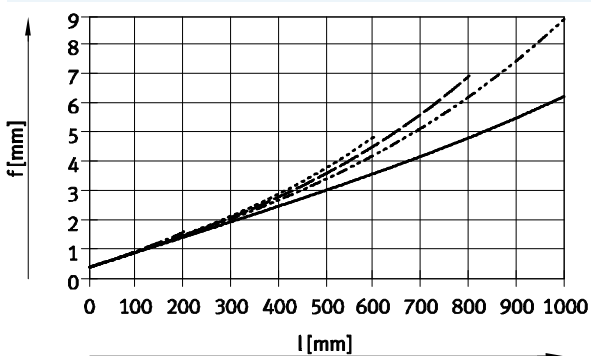

- Lateral force = 0 N
- - - Lateral force = 20 N
- · - Lateral force = 30 N
- · · - Lateral force = 40 N
- · · - Lateral force = 95 N

Electric cylinders DNCE, with spindle drive

Technical data

Mean feed force F as a function of running performance L (to DIN 69 051-4)

DNCE-32-...-BS-...

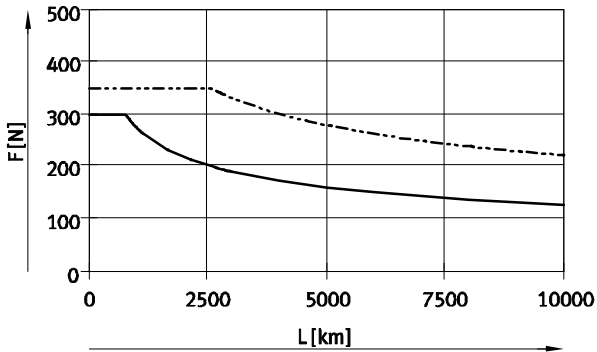

— DNCE-32-BS-3\"P
 - - - DNCE-32-BS-10\"P

DNCE-40-...-BS-...

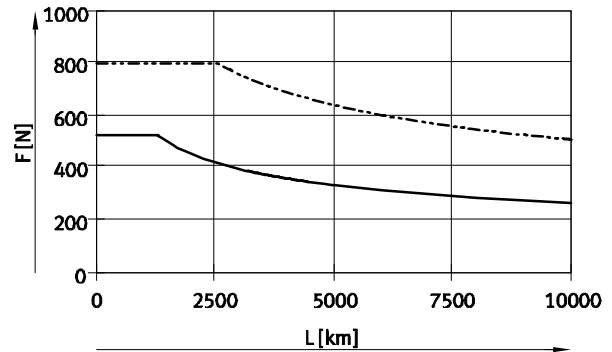

— DNCE-40-BS-5\"P
 - - - DNCE-40-BS-12,7\"P

DNCE-63-...-BS-...

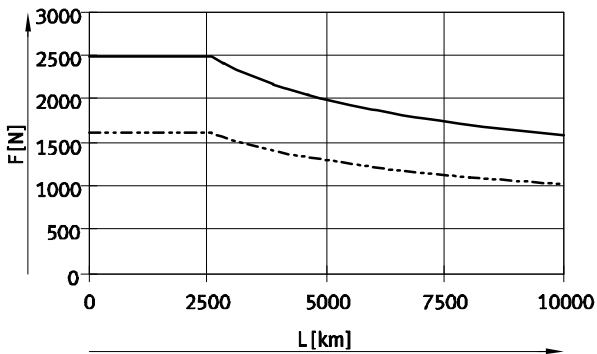

— DNCE-63-BS-10\"P
 - - - DNCE-63-BS-20\"P

Note

- The specifications for running performance are based on experimentally determined and theoretically calculated data. The running performance attainable in practice can deviate considerably from the specified curves under different parameters.

Electric cylinders DNCE, with spindle drive

Technical data

Dimensions Download CAD data → www.festo.com

Basic version

+ = plus stroke length

Size	AM	B ∅ d11	B1	B2	BG	D1 ∅ h9	D2 ∅ h6	D3 ∅ f7	D4	E	G	G1	H1	H2	KK
32	22	30	19	32	16	16	6	32	M3	45.5	24	26	19	32	M10x1.25
40	24	35	20	42	16	20	8	40	M4	54	28.5	30	20	42	M12x1.25
63	32	45	31	62	17	28	12	60	M5	75.5	34	36	31	62	M16x1.5

Size	L1	L2	L3	L4	L5	MM	MP	RT	TG	VA	VD +1/-0.7	WH	ZJ ±1	∅C1	∅C2	∅C3
32	18	122	15.9	8	3.5	12	M3	M6	32.5	7	10	26	148	10	17	6
40	21.5	146.5	18.4	14	3.5	16	M3	M6	38	7	10.5	30	176.5	13	19	6
63	28.5	177	23.5	17	4.5	20	M4	M8	56.5	9	15	37	214	17	24	8

Variants

K8 – Extended piston rod

K3 – Female piston rod thread

P5 – Protection class IP65

Size [mm]	A2 max.	AF	EE	KF	L6	T5	D5	WH
32	200	12	G $\frac{1}{8}$	M6	37.6	2.6	6.4	26
40	200	12	G $\frac{1}{4}$	M8	45.6	3.3	8.4	30
63	200	16	G $\frac{1}{4}$	M10	57.6	4.7	10.5	37

Electric cylinders DNCE, with spindle drive

Technical data

FESTO

Ordering data – DNCE-32					
Stroke [mm]	Part No.	Type	Stroke [mm]	Part No.	Type
Ball screw spindle with spindle pitch 3 mm			Lead screw spindle with spindle pitch 1.5 mm		
100	543115	DNCE-32-100-BS-”3”P-Q	100	543111	DNCE-32-100-LS-”1,5”P-Q
200	543116	DNCE-32-200-BS-”3”P-Q	200	543112	DNCE-32-200-LS-”1,5”P-Q
300	543117	DNCE-32-300-BS-”3”P-Q	300	543113	DNCE-32-300-LS-”1,5”P-Q
400	543118	DNCE-32-400-BS-”3”P-Q	400	543114	DNCE-32-400-LS-”1,5”P-Q
Ball screw spindle with spindle pitch 10 mm					
100	543119	DNCE-32-100-BS-”10”P-Q			
200	543120	DNCE-32-200-BS-”10”P-Q			
300	543121	DNCE-32-300-BS-”10”P-Q			
400	543122	DNCE-32-400-BS-”10”P-Q			

Ordering data – DNCE-40					
Stroke [mm]	Part No.	Type	Stroke [mm]	Part No.	Type
Ball screw spindle with spindle pitch 5 mm			Lead screw spindle with spindle pitch 2.5 mm		
100	543127	DNCE-40-100-BS-”5”P-Q	100	543123	DNCE-40-100-LS-”2,5”P-Q
200	543128	DNCE-40-200-BS-”5”P-Q	200	543124	DNCE-40-200-LS-”2,5”P-Q
300	555466	DNCE-40-300-BS-”5”P-Q	300	555465	DNCE-40-300-LS-”2,5”P-Q
400	543129	DNCE-40-400-BS-”5”P-Q	400	543125	DNCE-40-400-LS-”2,5”P-Q
600	543130	DNCE-40-600-BS-”5”P-Q	600	543126	DNCE-40-600-LS-”2,5”P-Q
Ball screw spindle with spindle pitch 12.7 mm					
100	543131	DNCE-40-100-BS-”12,7”P-Q			
200	543132	DNCE-40-200-BS-”12,7”P-Q			
300	555467	DNCE-40-300-BS-”12,7”P-Q			
400	543133	DNCE-40-400-BS-”12,7”P-Q			
600	543134	DNCE-40-600-BS-”12,7”P-Q			

Ordering data – DNCE-63					
Stroke [mm]	Part No.	Type	Stroke [mm]	Part No.	Type
Ball screw spindle with spindle pitch 10 mm			Lead screw spindle with spindle pitch 4 mm		
100	555470	DNCE-63-100-BS-”10”P-Q	100	555468	DNCE-63-100-LS-”4”P-Q
200	543139	DNCE-63-200-BS-”10”P-Q	200	543135	DNCE-63-200-LS-”4”P-Q
300	555471	DNCE-63-300-BS-”10”P-Q	300	555469	DNCE-63-300-LS-”4”P-Q
400	543140	DNCE-63-400-BS-”10”P-Q	400	543136	DNCE-63-400-LS-”4”P-Q
600	543141	DNCE-63-600-BS-”10”P-Q	600	543137	DNCE-63-600-LS-”4”P-Q
800	543142	DNCE-63-800-BS-”10”P-Q	800	543138	DNCE-63-800-LS-”4”P-Q
Ball screw spindle with spindle pitch 20 mm					
100	555472	DNCE-63-100-BS-”20”P-Q			
200	543143	DNCE-63-200-BS-”20”P-Q			
300	555473	DNCE-63-300-BS-”20”P-Q			
400	543144	DNCE-63-400-BS-”20”P-Q			
600	543145	DNCE-63-600-BS-”20”P-Q			
800	543146	DNCE-63-800-BS-”20”P-Q			

 Note
 Order variable strokes via the modular product system → 17

Electric cylinders DNCE, with spindle drive

Ordering data – Modular products

Ordering table						
Size	32	40	63	Condi- tions	Code	Enter code
M Module No.	555488	555489	555490			
Function	Electric cylinder				DNCE	DNCE
Size	32	40	63		-...	
Stroke [mm]	100				-...	
	200					
	300					
	400					
	-	600				
	-	-	800			
	1 ... 400	1 ... 600	1 ... 800	[1]		
Drive type	Lead screw spindle				-LS	
	Ball screw spindle				-BS	
Spindle pitch [mm]	1.5	-	-	[2]	-“...”P	
	-	2.5	-	[2]		
	3	-	-	[3]		
	-	-	4	[2]		
	-	5	-	[3]		
	10	-	10	[3]		
	-	12.7	-	[3]		
	-	-	20	[3]		
Protection against rotation	Non-rotating piston rod				-Q	-Q
O Extended piston rod	1 ... 200			[3]	-...K8	
Female thread	M6	M8	M10	[3]	-K3	
Protection class to IEC 60529	IP65			[3]	-P5	
Corrosion protection	High corrosion protection			[3] [4]	-R3	
Lubrication	Lubrication approved for use in food applications			[3] [5]	-FG	

- [1] ... Additional stroke lengths on request
- [2] **“1.5”P, “2.5”P, “4”P**
Only with drive type LS
- [3] **“3”P, “5”P, “10”P, “12.7”P, “20”P, ...K8, K3, P5**
Only with ball screw spindle BS
- [4] **R3** Only with P5
- [5] **FG** Only with R3 and P5

Transfer order code

DNCE - - - - - - **Q** - - -

Electric cylinders DNCE, with spindle drive

Accessories

 Note

Depending on the combination of motor and drive, it may not be possible to reach the maximum feed force of the drive.

When using parallel kits, the no-load driving torque of the respective kit must be taking into consideration.

The following tool is available for sizing:
PositioningDrives engineering software
→ www.festo.com

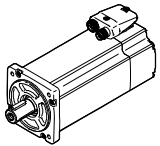
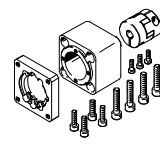
Permissible axis/motor combinations with axial kit		Technical data → Internet: eamm-a	
Motor/gear unit ¹⁾	Axial kit		
			
Type	Part No.	Type	
DNCE-32			
With servo motor			
EMME-AS-40-...	1976465	EAMM-A-D32-40P	
	2207372	EAMM-A-D32-40P-S1 ²⁾	
EMMS-AS-40-...	543147	EAMM-A-D32-40A	
	1322178	EAMM-A-D32-40A-S1 ²⁾	
EMMS-AS-55-...	550979	EAMM-A-D32-55A	
	1322180	EAMM-A-D32-55A-S1 ²⁾	
EMME-AS-60-...	1956054	EAMM-A-D32-60P	
	2234020	EAMM-A-D32-60P-S1 ²⁾	
With stepper motor			
EMMS-ST-42-...	543148	EAMM-A-D32-42A	
	1322179	EAMM-A-D32-42A-S1 ²⁾	
EMMS-ST-57-...	550980	EAMM-A-D32-57A	
	1322181	EAMM-A-D32-57A-S1 ²⁾	
With motor unit ³⁾			
MTR-DCI-32S-...	543149	EAMM-A-D32-32B	
DNCE-40			
With servo motor			
EMMS-AS-55-...	543153	EAMM-A-D40-55A	
	1322182	EAMM-A-D40-55A-S1 ²⁾	
EMME-AS-60-...	1977000	EAMM-A-D40-60P	
	2151519	EAMM-A-D40-60P-S1 ²⁾	
EMMS-AS-70-...	550981	EAMM-A-D40-70A	
	1322185	EAMM-A-D40-70A-S1 ²⁾	
With servo motor and gear unit			
EMME-AS-40-...	560282	EAMM-A-D40-40G	
EMGA-40-P-G...-EAS-40			
EMMS-AS-40-...	560282	EAMM-A-D40-40G	
EMGA-40-P-G...-SAS-40			

1) The input torque must not exceed the maximum permissible transferable torque of the axial kit.
 2) With degree of protection IP65.
 3) Only in combination with DNCE-...-LS.

Electric cylinders DNCE, with spindle drive

Accessories

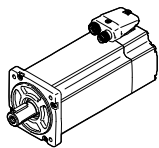
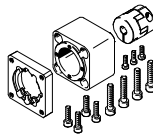
Permissible axis/motor combinations with axial kit		Technical data → Internet: eamm-a
Motor/gear unit ¹⁾	Axial kit	
		
Type	Part No.	Type
With stepper motor		
DNCE-40		
EMMS-ST-57-...	543154	EAMM-A-D40-57A
	1322183	EAMM-A-D40-57A-S1 ²⁾
EMMS-ST-87-...	550982	EAMM-A-D40-87A
	1322186	EAMM-A-D40-87A-S1 ²⁾
With stepper motor and gear unit		
EMMS-ST-42-...	560282	EAMM-A-D40-40G
EMGA-40-P-G...-SST-42		
With motor unit³⁾		
MTR-DCI-42S-...-G7	543155	EAMM-A-D40-42B
MTR-DCI-42S-...-G14	543156	EAMM-A-D40-42C
DNCE-63		
With servo motor		
EMMS-AS-70-...	543161	EAMM-A-D60-70A
	1322187	EAMM-A-D60A-70A-S1 ²⁾
EMME-AS-80-...	1977073	EAMM-A-D60-80P
	2218564	EAMM-A-D60-80P-S1 ²⁾
EMME-AS-100-...	550983	EAMM-A-D60-100A
	1322190	EAMM-A-D60A-100A-S1 ²⁾
EMMS-AS-100-...	550983	EAMM-A-D60-100A
	1322190	EAMM-A-D60A-100A-S1 ²⁾
With servo motor and gear unit		
EMMS-AS-55-...	560283	EAMM-A-D60-60G
EMGA-60-P-G...-SAS-55		
EMMS-AS-70-...	560283	EAMM-A-D60-60G
EMGA-60-P-G...-SAS-70		
With stepper motor		
EMMS-ST-87-...	543162	EAMM-A-D60-87A
	1322188	EAMM-A-D60-87A-S1 ²⁾
With stepper motor and gear unit		
EMMS-ST-57-...	560283	EAMM-A-D60-60G
EMGA-60-P-G...-SST-57		
With motor unit³⁾		
MTR-DCI-52S-...-G7	543163	EAMM-A-D60-52B
MTR-DCI-52S-...-G14	543164	EAMM-A-D60-52C

1) The input torque must not exceed the maximum permissible transferable torque of the axial kit.

2) With degree of protection IP65.

3) Only in combination with DNCE-...-LS.

 Note

The axial kit (without "S1" in the type code) can be retrofitted with a degree of protection from IP40 to IP65. More information → eamm-u

The axial kit (without "S1" in the type code) can be retrofitted with a seal set EADS-F to change the

Electric cylinders DNCE, with spindle drive



Accessories



Component parts of the axial kit				
Axial kit	Comprising:			
	Motor flange	Coupling	Coupling housing	Seal set
Part No. Type	Part No.. Type	Part No. Type	Part No. Type	Part No. Type
DNCE-32				
543149 EAMM-A-D32-32B	–	543420 EAMC-16-20-6-6	552156 EAMK-A-D32-32B	–
543147 EAMM-A-D32-40A	552163 EAMF-A-28B-40A	543420 EAMC-16-20-6-6	552155 EAMK-A-D32-28B	–
1322178 EAMM-A-D32-40A-S1				1561526 EADS-F-D32-40A
1976465 EAMM-A-D32-40P	1976704 EAMF-A-28B-40P	1232854 EAMC-16-20-6-8	552155 EAMK-A-D32-28B	–
2207372 EAMM-A-D32-40P-S1				2207219 EADS-F-D32-40P
543148 EAMM-A-D32-42A	552164 EAMF-A-28B-42A	543419 EAMC-16-20-5-6	552155 EAMK-A-D32-28B	–
1322179 EAMM-A-D32-42A-S1				1561527 EADS-F-D32-42A
550979 EAMM-A-D32-55A	529942 EAMF-A-44A/B-55A	551003 EAMC-30-32-6-9	551006 EAMK-A-D32-44A/C	–
1322180 EAMM-A-D32-55A-S1				1561528 EADS-F-D32-55A
550980 EAMM-A-D32-57A	530081 EAMF-A-44A/B-57A	551002 EAMC-30-32-6-6.35	551006 EAMK-A-D32-44A/C	–
1322181 EAMM-A-D32-57A-S1				1561529 EADS-F-D32-57A
1956054 EAMM-A-D32-60P	1956846 EAMF-A-44C-60P	1233256 EAMC-30-32-6-14	551006 EAMK-A-D32-44A/C	–
2234020 EAMM-A-D32-60P-S1				2234012 EADS-F-D32-60P

Electric cylinders DNCE, with spindle drive

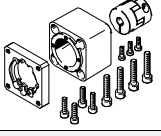

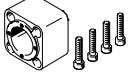
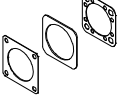
Accessories

Part components of the axial kit				
Axial kit	Comprising:			
	Motor flange	Coupling	Coupling housing	Seal set
				
Part No. Type	Part No. Type	Part No. Type	Part No. Type	Part No. Type
DNCE-40				
543155 EAMM-A-D40-42B	–	543422 EAMC-30-32-8-8	552158 EAMK-A-D40-42B	–
543156 EAMM-A-D40-42C	–	543422 EAMC-30-32-8-8	552159 EAMK-A-D40-42C	–
543153 EAMM-A-D40-55A	529942 EAMF-A-44A/B-55A	543423 EAMC-30-32-8-9	552157 EAMK-A-D40-44A/C	–
1322182 EAMM-A-D40-55A-S1				1561530 EADS-F-D40-55A
543154 EAMM-A-D40-57A	530081 EAMF-A-44A/B-57A	543421 EAMC-30-32-6.35-8	552157 EAMK-A-D40-44A/C	–
1322183 EAMM-A-D40-57A-S1				1561531 EADS-F-D40-57A
1977000 EAMM-A-D40-60P	1956846 EAMF-A-44C-60P	562682 EAMC-30-32-8-14	552157 EAMK-A-D40-44A/C	–
2151519 EAMM-A-D40-60P-S1				2151545 EADS-F-D40-60P
550981 EAMM-A-D40-70A	529943 EAMF-A-44A/B-70A	551004 EAMC-30-32-8-11	552157 EAMK-A-D40-44A/C	–
1322185 EAMM-A-D40-70A-S1				1561532 EADS-F-D40-70A
550982 EAMM-A-D40-87A	530082 EAMF-A-44A/B-87A	551004 EAMC-30-32-8-11	552157 EAMK-A-D40-44A/C	–
1322186 EAMM-A-D40-87A-S1				1561533 EADS-F-D40-87A
560282 EAMM-A-D40-40G	550986 EAMF-44A/B-40G	558029 EAMC-30-32-8-10	552157 EAMK-A-D40-44A/C	–

Electric cylinders DNCE, with spindle drive

Accessories

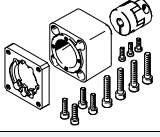
FESTO

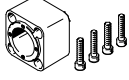
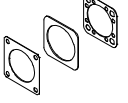
Component parts of the axial kit				
Axial kit	Comprising:			
	Motor flange	Coupling	Coupling housing	Seal set
				
Part No. Type	Part No. Type	Part No. Type	Part No. Type	Part No. Type
DNCE-63				
543163 EAMM-A-D60-52B	–	533709 EAMC-42-50-12-12	552161 EAMK-A-D60-52B	–
543164 EAMM-A-D60-52C	–	533709 EAMC-42-50-12-12	552162 EAMK-A-D60-52C	–
543161 EAMM-A-D60-70A	529945 EAMF-A-64A/B-70A	543424 EAMC-42-50-11-12	552160 EAMK-A-D60-64B	–
1322187 EAMM-A-D60A-70A-S1				1561534 EADS-F-D60A-70A
1977073 EAMM-A-D60-80P	1977113 EAMF-A-64A/C-80P	551005 EAMC-42-50-12-19	551007 EAMK-A-D60-64C	–
2218564 EAMM-A-D60-80P-S1				2218523 EADS-F-D60-80P
543162 EAMM-A-D60-87A	533140 EAMF-A-64A/B-87A	543424 EAMC-42-50-11-12	552160 EAMK-A-D60-64B	–
1322188 EAMM-A-D60-87A-S1				1561536 EADS-F-D60-87A
550983 EAMM-A-D60-100A	529947 EAMF-A-64A/C/D-100A	551005 EAMC-42-50-12-19	551007 EAMK-A-D60-64C	–
1322190 EAMM-A-D60A-100A-S1				1561537 EADS-F-D60A-100A
560283 EAMM-A-D60-60G	550987 EAMF-A-64A/B-60G/H	543424 EAMC-42-50-11-12	552160 EAMK-A-D60-64B	–

Electric cylinders DNCE, with spindle drive

Accessories

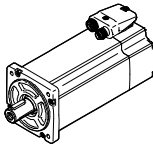
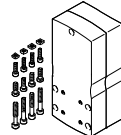
Permissible axis/motor combinations with parallel kit		Technical data → Internet: eamm-u
Motor/gear unit ¹⁾	Parallel kit	
		<ul style="list-style-type: none"> • Increased housing rigidity • More flexible motor mounting possible • Larger toothed belt bending radii for improved service life • Use in combination with third-party motors on request
Type	Part No.	Type
DNCE-32		
With servo motor		
EMME-AS-40-...	2153283	EAMM-U-50-D32-40P-78
	2154009	EAMM-U-50-D32-40AP-78-S1 ²⁾
EMMS-AS-40-...	1201591	EAMM-U-50-D32-40A-78
	1202302	EAMM-U-50-D32-40A-78-S1 ²⁾
EMMS-AS-55-...	1210126	EAMM-U-60-D32-55A-91
	1210450	EAMM-U-60-D32-55A-91-S1 ²⁾
EMME-AS-60-...	2619586	EAMM-U-70-D32-60P-96
	2619688	EAMM-U-70-D32-60P-96-S1 ²⁾
EMMS-AS-70-...	2755565	EAMM-U-70-D32-70A-96
	2781711	EAMM-U-70-D32-70A-96-S1 ²⁾
With stepper motor		
EMMS-ST-42-...	1201607	EAMM-U-50-D32-42A-78
	1202312	EAMM-U-50-D32-42A-78-S1 ²⁾
EMMS-ST-57-...	1210419	EAMM-U-60-D32-57A-91
	1210453	EAMM-U-60-D32-57A-91-S1 ²⁾
With motor unit ³⁾		
MTR-DCI-32S-...	1570862	EAMM-U-50-D32-32B-78
MTR-DCI-42S-...	1577393	EAMM-U-60-D32-42B/C-91
	1577380	EAMM-U-60-D32-42B/C-91-S1 ²⁾
MTR-DCI-52S-...	2755890	EAMM-U-70-D32-52B/C-96
	2781778	EAMM-U-70-D32-52B/C-96-S1 ²⁾
With gear unit		
EMGA-40-P-...	1577358	EAMM-U-60-D32-40G-91
EMGC-40-P-...	1577346	EAMM-U-60-D32-40G-91-S1 ²⁾
EMGA-60-P-...-SAS/SST ⁴⁾	2748181	EAMM-U-70-D32-60G-96
	2778302	EAMM-U-70-D32-60G-96-S1 ²⁾
EMGA-60-P-...-EAS,	2778393	EAMM-U-70-D32-60H-96
EMGC-60-P-... ⁴⁾	2781450	EAMM-U-70-D32-60H-96-S1 ²⁾

1) The input torque must not exceed the maximum permissible transferable torque of the parallel kit.

2) With degree of protection IP65



3) Only with DNCE-...-LS

4) Gear unit drive shaft Ø: EMGA-60-P-...-SAS/-SST11 mm; EMGA-60-P-...-EAS, EMGC-60-P14 mm

Electric cylinders DNCE, with spindle drive

Accessories

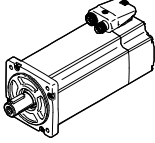
FESTO

Permissible axis/motor combinations with parallel kit		Technical data → Internet: eamm-u	
Motor/gear unit ¹⁾	Parallel kit		
			<ul style="list-style-type: none"> • Increased housing rigidity • More flexible motor mounting possible • Larger toothed belt bending radii for improved service life • Use in combination with third-party motors on request
Type	Part No.	Type	
DNCE-40			
With servo motor			
EMMS-AS-55-...	1210438	EAMM-U-60-D40-55A-91	
	1210458	EAMM-U-60-D40-55A-91-S1 ²⁾	
EMME-AS-60-...	2617488	EAMM-U-70-D40-60P-96	
	2546123	EAMM-U-70-D40-60P-96-S1 ²⁾	
EMMS-AS-70-...	2786204	EAMM-U-70-D40-70A-96	
	2786316	EAMM-U-70-D40-70A-96-S1 ²⁾	
EMMS-AS-70-...	1212826	EAMM-U-86-D40-70A-102	
	1212854	EAMM-U-86-D40-70A-102-S1 ²⁾	
EMME-AS-80-...	2802441	EAMM-U-86-D40-80P-102	
	2802656	EAMM-U-86-D40-80P-102-S1 ²⁾	
With stepper motor			
EMMS-ST-57-...	1210442	EAMM-U-60-D40-57A-91	
	1210462	EAMM-U-60-D40-57A-91-S1 ²⁾	
EMMS-ST-87-...	1215802	EAMM-U-86-D40-87A-102	
	1215814	EAMM-U-86-D40-87A-102-S1 ²⁾	
With motor unit ³⁾			
MTR-DCI-42S-...	1570950	EAMM-U-60-D40-42B/C-91	
	1430735	EAMM-U-60-D40-42B/C-91-S1 ²⁾	
MTR-DCI-52S-...	2786802	EAMM-U-70-D40-52B/C-96	
	2786845	EAMM-U-70-D40-52B/C-96-S1 ²⁾	
MTR-DCI-52S-...	1537046	EAMM-U-86-D40-52B/C-102	
	1537011	EAMM-U-86-D40-52B/C-102-S1 ²⁾	
With gear unit			
EMGA-40-P-...	1577165	EAMM-U-60-D40-40G-91	
EMGC-40-P-...	1435968	EAMM-U-60-D40-40G-91-S1 ²⁾	
EMGA-60-P-...-SAS/SST ⁴⁾	2785471	EAMM-U-70-D40-60G-96	
	2785542	EAMM-U-70-D40-60G-96-S1 ²⁾	
EMGA-60-P-...-EAS, EMGC-60-P-... ⁴⁾	2786101	EAMM-U-70-D40-60H-96	
	2786137	EAMM-U-70-D40-60H-96-S1 ²⁾	
EMGA-60-P-...-SAS/SST ⁴⁾	1586445	EAMM-U-86-D40-60G-102	
	1586429	EAMM-U-86-D40-60G-102-S1 ²⁾	
EMGA-60-P-...-EAS, EMGC-60-P-... ⁴⁾	1586496	EAMM-U-86-D40-60H-102	
	1586372	EAMM-U-86-D40-60H-102-S1 ²⁾	

1) The input torque must not exceed the maximum permissible transferable torque of the parallel kit.



2) With degree of protection IP65

3) Only with DNCE-...-LS

4) Gear unit drive shaft \varnothing : EMGA-60-P-...-SAS/SST11 mm; EMGA-60-P-...-EAS, EMGC-60-P14 mm

Electric cylinders DNCE, with spindle drive

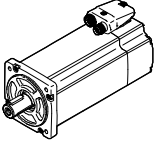
Accessories

Permissible axis/motor combinations with parallel kit		Technical data → Internet: eamm-u
Motor/gear unit ¹⁾	Parallel kit	
		<ul style="list-style-type: none"> • Increased housing rigidity • More flexible motor mounting possible • Larger toothed belt bending radii for improved service life • Use in combination with third-party motors on request
Type	Part No.	Type
DNCE-63		
With servo motor		
EMMS-AS-70-...	1212477	EAMM-U-86-D60-70A-102
	1212835	EAMM-U-86-D60-70A-102-S1 ²⁾
EMME-AS-80-...	2155875	EAMM-U-86-D60-80P-102
	2156527	EAMM-U-86-D60-80P-102-S1 ²⁾
EMME-AS-100-...	1202436	EAMM-U-110-D60-100A-120
	1203112	EAMM-U-110-D60-100A-120-S1 ²⁾
EMMS-AS-100-...	1202436	EAMM-U-110-D60-100A-120
	1203112	EAMM-U-110-D60-100A-120-S1 ²⁾
With stepper motor		
EMMS-ST-87-...	1215784	EAMM-U-86-D60-87A-102
	1215810	EAMM-U-86-D60-87A-102-S1 ²⁾
With motor unit ³⁾		
MTR-DCI-52S-...	1537000	EAMM-U-86-D60-52B/C-102
	1431381	EAMM-U-86-D60-52B/C-102-S1 ²⁾
MTR-DCI-62S-...	1536988	EAMM-U-110-D60-62B-120
	1431443	EAMM-U-110-D60-62B-120-S1 ²⁾
With gear unit		
EMGA-60-P-...-SAS/SST⁴⁾	1586347	EAMM-U-86-D60-60G-102
	1437163	EAMM-U-86-D60-60G-102-S1 ²⁾
EMGA-60-P-...-EAS, EMGC-60-P-...⁴⁾	1586276	EAMM-U-86-D60-60H-102
	1530837	EAMM-U-86-D60-60H-102-S1 ²⁾
EMGA-60-P-...-SAS/SST⁴⁾	1543240	EAMM-U-110-D60-60G-120
	1436183	EAMM-U-110-D60-60G-120-S1 ²⁾
EMGA-60-P-...-EAS, EMGC-60-P-...⁴⁾	1542264	EAMM-U-110-D60-60H-120
	1530621	EAMM-U-110-D60-60H-120-S1 ²⁾
EMGA-80-P-...	1532949	EAMM-U-110-D60-80G-120
	1530875	EAMM-U-110-D60-80G-120-S1 ²⁾

1) The input torque must not exceed the maximum permissible transferable torque of the parallel kit.

2) With degree of protection IP65

3) Only with DNCE-...-LS

4) Gear unit drive shaft Ø: EMGA-60-P-...-SAS/SST11 mm; EMGA-60-P-...-EAS, EMGC-60-P14 mm

 - Note

The clamping component EADT is required to adjust the toothed belt pretension with EAMM-U-110.

The motor and/or axis shaft can optionally be supported with a counter bearing EAMG.

More information → eamm-u

Electric cylinders DNCE, with spindle drive

Accessories

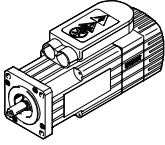
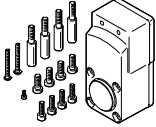
Permissible axis/motor combinations with parallel kit		Technical data → Internet: eamm-u
Motor ¹⁾	Parallel kit	
		<ul style="list-style-type: none"> • Space-saving gravity die-cast housing
Type	Part No.	Type
DNCE-32		
With servo motor		
EMMS-AS-40-...	543150	EAMM-U-D32-40A
With motor unit ²⁾		
MTR-DCI-32S-...	543152	EAMM-U-D32-32B
DNCE-40		
With servo motor		
EMMS-AS-55-...	543157	EAMM-U-D40-55A
With motor unit ²⁾		
MTR-DCI-42S-...-G7	543159	EAMM-U-D40-42B
MTR-DCI-42S-...-G14	543160	EAMM-U-D40-42C
DNCE-63		
With servo motor		
EMMS-AS-70-...	543165	EAMM-U-D60-70A
With motor unit ²⁾		
MTR-DCI-52S-...-G7	543167	EAMM-U-D60-52B
MTR-DCI-52S-...-G14	543168	EAMM-U-D60-52C

1) The input torque must not exceed the maximum permissible transferable torque of the parallel kit.
 2) Only with DNCE-...-LS

Electric cylinders DNCE, with spindle drive

Accessories

FESTO

Protective bellows kit EADB



General technical data				
Type EADB-V1-		32	40	63
Max. stroke range of cylinder ¹⁾	[mm]	10 ... 400	10 ... 500	10 ... 500
Type of mounting		Push-on		
		Via threaded pin		
Mounting position		Any		
Resistance to media		Dust, chippings, oil, grease, petrol (→ Internet: Resistance to media)		
Ambient temperature ²⁾	[°C]	-10 ... +80		
Degree of protection to IEC 60529		IP65		
Corrosion resistance class CRC ³⁾		3		

1) In combination with the protective bellows kit EADB

2) Note operating range of proximity sensors and cylinder

3) Corrosion resistance class CRC 3 to Festo standard FN 940070

High corrosion stress. Outdoor exposure under moderate corrosive conditions. External visible parts with primarily functional requirements for the surface and which are in direct contact with a normal industrial environment.

Materials

Sectional view

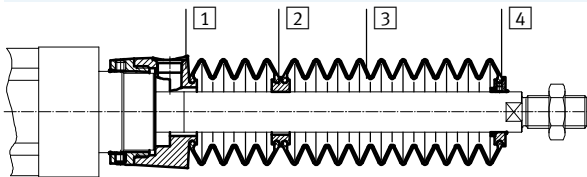

Bellows		
1	Connection	Anodised wrought aluminium alloy
2	Adapter	Polyamide
3	Bellows	NBR
4	End piece	Anodised wrought aluminium alloy
-	O-ring	NBR
Note on materials		Free of copper and PTFE RoHS-compliant

Weight [g]				
Type EADB-V1-		32	40	63
Stroke [mm]				
Product weight				
10 ... 100		77	116	196
101 ... 200		108	153	263
201 ... 300		122	172	309
301 ... 400		153	209	376
401 ... 500		-	227	397
Moving load				
10 ... 100		35	43	86
101 ... 200		66	80	153
201 ... 300		80	99	199
301 ... 400		111	136	266
401 ... 500		-	154	287

Electric cylinders DNCE, with spindle drive

Accessories



Travel speed v as a function of tubing length l



The protective bellows kit is a leak-free system. To prevent unwanted media from being drawn in, the supply and exhaust air for the kit must be ducted via a

pressure compensation hole in the connection part **1**. The pressure generated in the protective bellows kit by the positioning motion is primarily defined by the travel

speed and tubing length. The recommended tubing length based on the travel speed of the drive can be read from the graph.

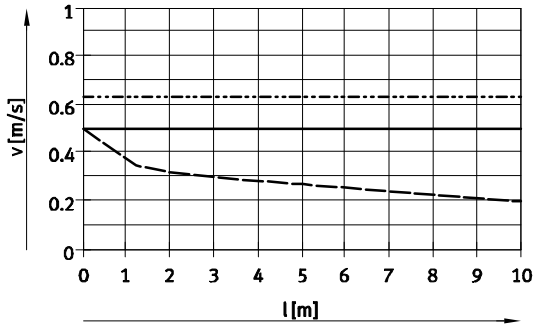

— EADB-V1-32/tubing Ø 8 mm
 - - - EADB-V1-40/tubing Ø 16 mm
 - · - EADB-V1-63/tubing Ø 16 mm

Note
 The push-in fittings in the adjacent table must be used for the pressure compensation hole. Silencers can be used as an alternative. This reduces the travel speed slightly.

Tubing size and push-in fitting			
Ø [mm]	Tubing O.D. [mm]	Part No.	Push-in fitting Type
32	8	186109	QS-G ¹ / ₈ -8-I
		578376	NPQH-DK-G18-Q8-P10
40, 63	16	186350	QS-G ¹ / ₄ -12
		578344	NPQH-D-G14-Q12-P10
		153261	QSH-16-12

Dimensions

Download CAD data → www.festo.com

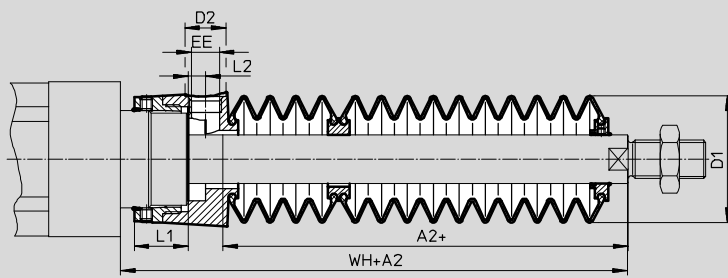

+ = plus stroke length

Ø Stroke [mm]	32							40						
	A2 ¹⁾	D1 max.	D2	EE	L1	L2	WH+A2	A2 ¹⁾	D1 max.	D2	EE	L1	L2	WH+A2
10 ... 100	44	46	14	G ¹ / ₈	12.9	5.4	70	48	57	17	G ¹ / ₄	16.3	7	78
101 ... 200	74						100	77						107
201 ... 300	88						114	88						118
301 ... 400	117						143	117						147
401 ... 500	-	-	-	-	-	-	-	135	-	-	-	-	-	165

Ø Stroke [mm]	63						
	A2 ¹⁾	D1 max.	D2	EE	L1	L2	WH+A2
10 ... 100	43	93	17	G ¹ / ₄	22.4	7	80
101 ... 200	68						105
201 ... 300	80						117
301 ... 400	104						141
401 ... 500	117						154

1) The dimension corresponds to the K8 value (extended piston rod) of the cylinder

Electric cylinders DNCE, with spindle drive

Accessories

Ordering data – Protective bellows kit

An extended piston rod (order code K8) → 17 is absolutely essential when using a protective bellows kit.

The necessary dimension for K8 as a function of cylinder size and stroke as well as the corresponding protective bellows kit are indicated in the table below:

Order example:

Selected electric cylinder:

DNCE-32-250-BS-“3”P-Q-...K8

The dimension for the corresponding K8 value (see table):
88 mm

Complete type code for electric cylinder:

DNCE-32-250-BS-“3”P-Q-88K8

The corresponding protective bellows kit:

EADB-V1-32-S201-300

Cylinder data			Protective bellows kit		Cylinder data			Protective bellows kit	
∅	Stroke	Dimension for K8	Part No.	Type	∅	Stroke	Dimension for K8	Part No.	Type
[mm]	[mm]	[mm]			[mm]	[mm]	[mm]		
32	10 ... 100	44	570262	EADB-V1-32-S10-100	40	10 ... 100	48	570266	EADB-V1-40-S10-100
	101 ... 200	74	570263	EADB-V1-32-S101-200		101 ... 200	77	570267	EADB-V1-40-S101-200
	201 ... 300	88	570264	EADB-V1-32-S201-300		201 ... 300	88	570268	EADB-V1-40-S201-300
	301 ... 400	117	570265	EADB-V1-32-S301-400		301 ... 400	117	570269	EADB-V1-40-S301-400
	–					401 ... 500	135	570270	EADB-V1-40-S401-500
63	10 ... 100	43	570271	EADB-V1-63-S10-100					
	101 ... 200	68	570272	EADB-V1-63-S101-200					
	201 ... 300	80	570273	EADB-V1-63-S201-300					
	301 ... 400	104	570274	EADB-V1-63-S301-400					
	401 ... 500	117	570275	EADB-V1-63-S401-500					

Electric cylinders DNCE, with spindle drive

Accessories

Foot mounting HNCE for axial motor attachment

Materials:
Galvanised steel

Free of copper and PTFE

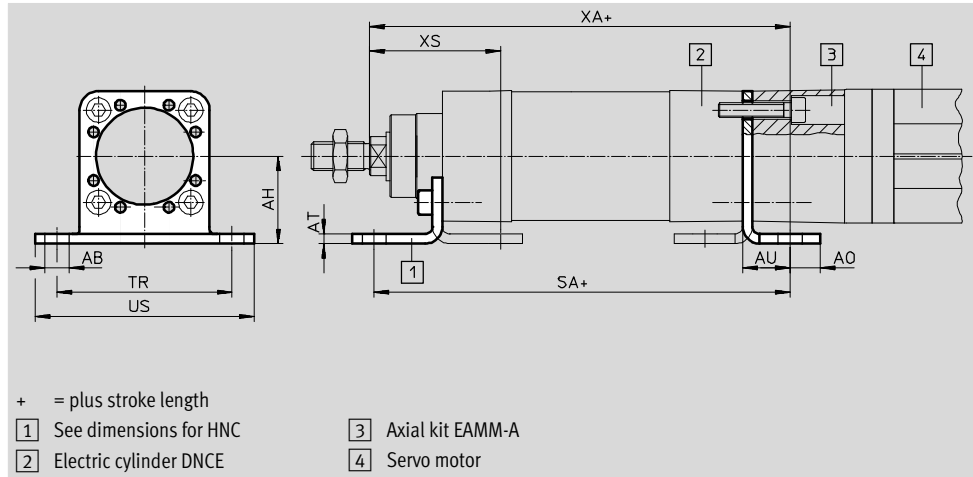

Dimensions and ordering data

For size	AB ∅	AH	AO	AT	AU	SA	TR	US	XA	XS
[mm]										
32	7	32	10.5	4	17.5	163.5	58	71	165.5	46
40	10	36	12.5	4	19.5	194.5	72	90	196	54
63	10	50	15	5	23	232	92	110	237	64

For size	CRC ¹⁾	Weight	Part No.	Type
[mm]		[g]		
32	1	160	547949	HNCE-32-AX
40	1	220	547950	HNCE-40-AX
63	1	470	547951	HNCE-63-AX

1) Corrosion resistance class CRC 1 to Festo standard FN 940070
Low corrosion stress. For dry indoor applications or transport and storage protection. Also applies to parts behind covers, in the non-visible interior area, and parts which are covered in the application (e.g. drive trunnions).

Electric cylinders DNCE, with spindle drive

Accessories

Profile mounting EAHF

Materials:

RoHS-compliant

Plate: Anodised aluminium

Clamping piece: Galvanised steel

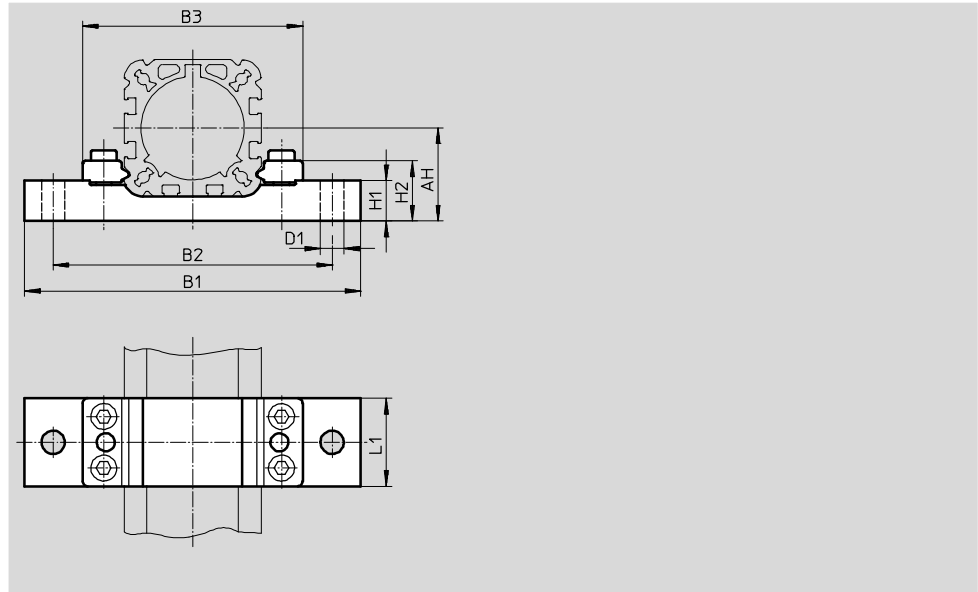

Dimensions and ordering data								
For size	AH	B1	B2	B3	D1	H1	H2	L1
[mm]					Ø			
32	32	100	84	66.1	6.6	17.5	26.1	32
40	36	130	108	85.2	9	15.7	23.3	34
63	50	150	128	104.8	9	22.9	30.4	41

For size	CRC ¹⁾	Weight	Part No.	Type
[mm]		[g]		
32	1	175	1098473	EAHF-V1-32-P
40	1	230	1098478	EAHF-V1-40-P
63	1	400	1098481	EAHF-V1-63-P

1) Corrosion resistance class CRC 1 to Festo standard FN 940070
 Low corrosion stress. For dry indoor applications or transport and storage protection. Also applies to parts behind covers, in the non-visible interior area, and parts which are covered in the application (e.g. drive trunnions).

Electric cylinders DNCE, with spindle drive

Accessories



Foot mounting HNC/CRHNC, for parallel motor attachment

Materials:
HNC: Galvanised steel

CRHNC: High-alloy steel
Free of copper and PTFE

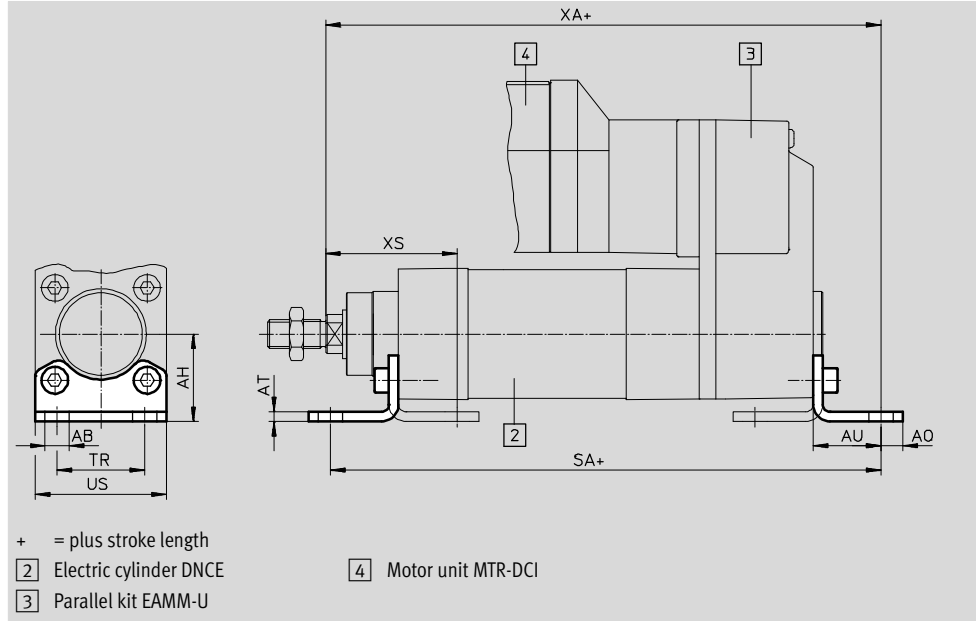

Dimensions and ordering data

For size	AB	AH	AO	AT	AU	SA	TR	US	XA	XS
[mm]	∅									
32	7	32	6.5	4	24	210	32	45	212	46
40	10	36	9	4	28	249.5	36	54	251.5	54
63	10	50	12.5	5	32	299	50	75	304	64

For size	Basic version				High corrosion protection			
	CRC ¹⁾	Weight [g]	Part No.	Type	CRC ¹⁾	Weight [g]	Part No.	Type
[mm]								
32	2	144	174369	HNC-32	4	139	176937	CRHNC-32
40	2	193	174370	HNC-40	4	188	176938	CRHNC-40
63	2	436	174372	HNC-63	4	424	176940	CRHNC-63

1) Corrosion resistance class CRC 2 to Festo standard FN 940070
Moderate corrosion stress. Indoor applications in which condensation may occur. External visible parts with primarily decorative requirements for the surface and which are in direct contact with the ambient atmosphere typical for industrial applications.
Corrosion resistance class CRC 4 to Festo standard FN 940070
Particularly high corrosion stress. Outdoor exposure under extreme corrosive conditions. Parts exposed to aggressive media, for instance in the chemical or food industries. These applications may need to be supported by special tests (→ also FN 940082) using appropriate media.

Electric cylinders DNCE, with spindle drive

Accessories



Flange mounting FNC/CRFNG

Materials:

FNC: Galvanised steel

CRFNG: High-alloy steel

Free of copper and PTFE

RoHS-compliant

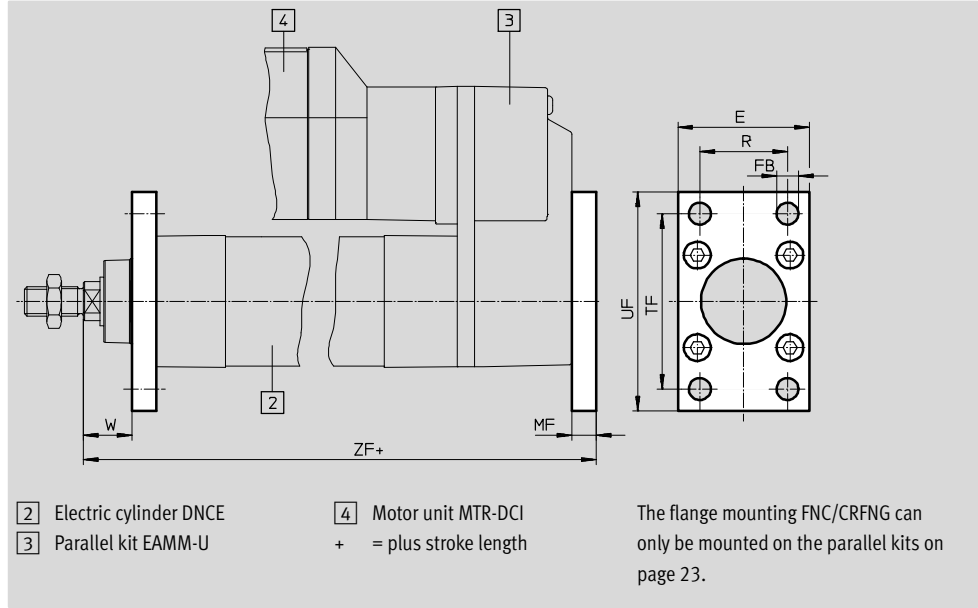

Dimensions and ordering data								
For size	E	FB ∅ H13	MF	R	TF	UF	W	ZF
[mm]								
32	45	7	10	32	64	80	16	198
40	54	9	10	36	72	90	20	233.5
63	75	9	12	50	100	120	25	284

For size [mm]	Basic version				High corrosion protection			
	CRC ¹⁾	Weight [g]	Part No.	Type	CRC ¹⁾	Weight [g]	Part No.	Type
32	1	221	174376	FNC-32	4	225	161846	CRFNG-32
40	1	291	174377	FNC-40	4	300	161847	CRFNG-40
63	1	679	174379	FNC-63	4	680	161849	CRFNG-63

1) Corrosion resistance class CRC 2 to Festo standard FN 940070
 Moderate corrosion stress. Indoor applications in which condensation may occur. External visible parts with primarily decorative requirements for the surface and which are in direct contact with the ambient atmosphere typical for industrial applications.
 Corrosion resistance class CRC 4 to Festo standard FN 940070
 Particularly high corrosion stress. Outdoor exposure under extreme corrosive conditions. Parts exposed to aggressive media, for instance in the chemical or food industries. These applications may need to be supported by special tests (→ also FN 940082) using appropriate media.

Electric cylinders DNCE, with spindle drive

Accessories



Trunnion flange ZNCF/CRZNG

Materials:

ZNCF: Stainless steel casting

CRZNG: Electropolished stainless steel casting

Free of copper and PTFE

RoHS-compliant

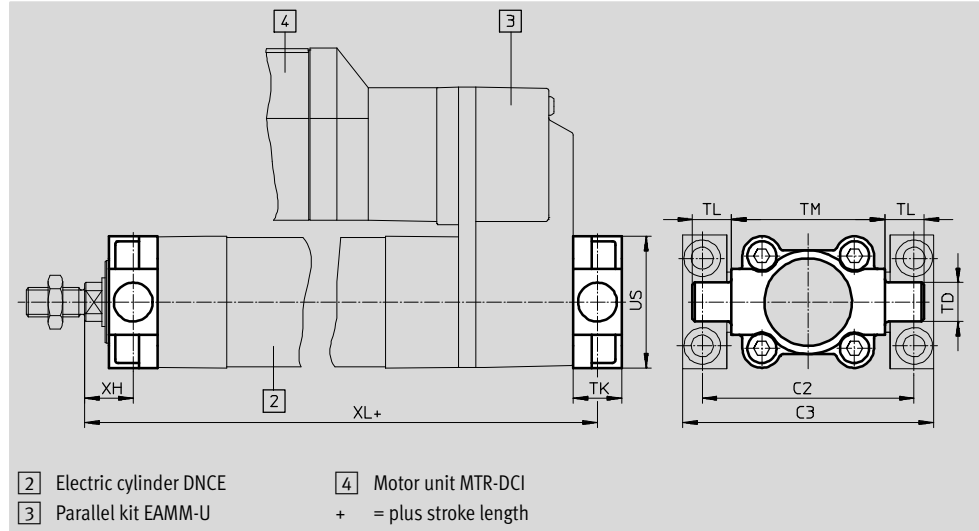

Dimensions and ordering data

For size	C2	C3	TD ∅ e9	TK	TL	TM	US	XH	XL
[mm]									
32	71	86	12	16	12	50	45	18	196
40	87	105	16	20	16	63	54	20	233.5
63	116	136	20	24	20	90	75	25	284

For size [mm]	Basic version				High corrosion protection			
	CRC ¹⁾	Weight [g]	Part No.	Type	CRC ¹⁾	Weight [g]	Part No.	Type
32	2	150	174411	ZNCF-32	4	150	161852	CRZNG-32
40	2	285	174412	ZNCF-40	4	285	161853	CRZNG-40
63	2	687	174414	ZNCF-63	4	687	161855	CRZNG-63

1) Corrosion resistance class CRC 2 to Festo standard FN 940070

Moderate corrosion stress. Indoor applications in which condensation may occur. External visible parts with primarily decorative requirements for the surface and which are in direct contact with the ambient atmosphere typical for industrial applications.

Corrosion resistance class CRC 4 to Festo standard FN 940070

Particularly high corrosion stress. Outdoor exposure under extreme corrosive conditions. Parts exposed to aggressive media, for instance in the chemical or food industries. These applications may need to be supported by special tests (→ also FN 940082) using appropriate media.

Electric cylinders DNCE, with spindle drive

Accessories

Trunnion support LNZG

Materials:

Trunnion support: Anodised aluminium

Plain bearing: Plastic

Free of copper and PTFE

RoHS-compliant

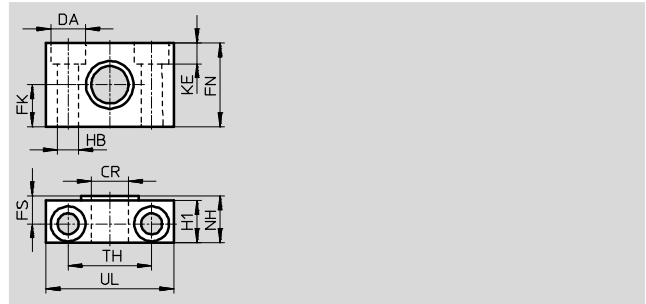

Dimensions and ordering data														Weight	Part No.	Type
For size	CR	DA	FK	FN	FS	H1	HB	KE	NH	TH	UL	CRC ¹⁾				
[mm]	∅ D11	∅ H13	∅ ±0.1				∅ H13			±0.2				[g]		
32	12	11	15	30	10.5	15	6.6	6.8	18	32	46	2		83	32959	LNZG-32
40	16	15	18	36	12	18	9	9	21	36	55	2		129	32960	LNZG-40/50
63	20	18	20	40	13	20	11	11	23	42	65	2		178	32961	LNZG-63/80

Trunnion support CRLNZG

Materials:

High-alloy steel

Free of copper and PTFE

RoHS-compliant

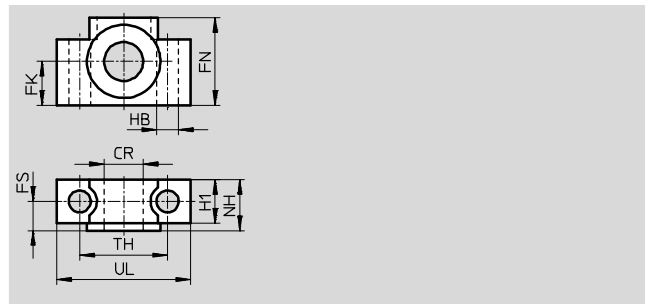
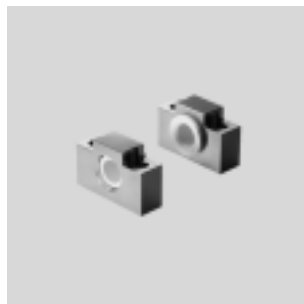

Dimensions and ordering data														Weight	Part No.	Type
For size	CR	FK	FN	FS	H1	HB	NH	TH	UL	CRC ¹⁾						
[mm]	∅ D11	∅ ±0.1				∅ H13		±0.2						[g]		
32	12	15	30	10.5	15	6.6	18	32	46	4				205	161874	CRLNZG-32
40	16	18	36	12	18	9	21	36	55	4				323	161875	CRLNZG-40/50
63	20	20	40	13	20	11	23	42	65	4				435	161876	CRLNZG-63/80

1) Corrosion resistance class CRC 2 to Festo standard FN 940070
 Moderate corrosion stress. Indoor applications in which condensation may occur. External visible parts with primarily decorative requirements for the surface and which are in direct contact with the ambient atmosphere typical for industrial applications.
 Corrosion resistance class CRC 4 to Festo standard FN 940070
 Particularly high corrosion stress. Outdoor exposure under extreme corrosive conditions. Parts exposed to aggressive media, for instance in the chemical or food industries. These applications may need to be supported by special tests (→ also FN 940082) using appropriate media.

Electric cylinders DNCE, with spindle drive

Accessories



Swivel flange SNC

Materials:
Die-cast aluminium

Free of copper and PTFE
RoHS-compliant

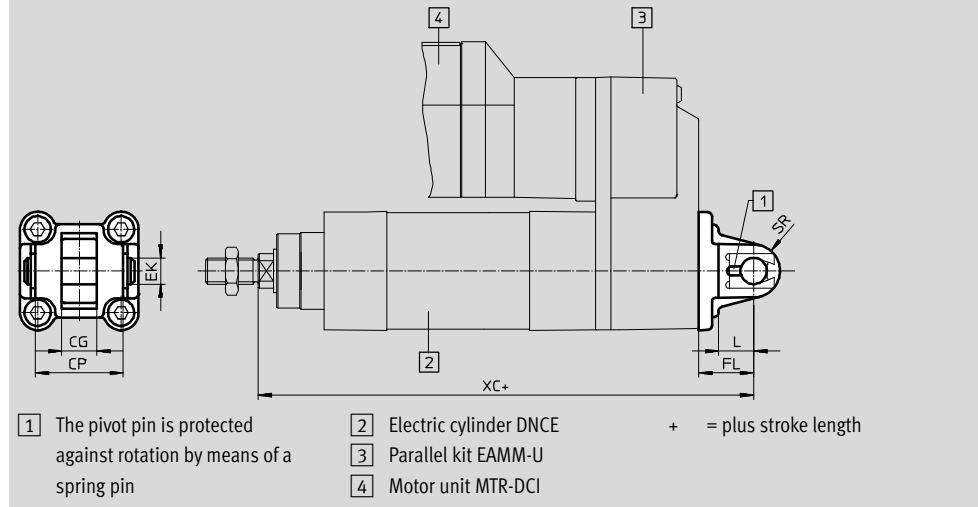

Dimensions and ordering data												
For size	CG	CP	EK ∅	FL ±0.2	L	SR	XC	CRC ¹⁾	Weight [g]	Part No.	Type	
[mm]	H14	H14										
32	14	34	10	22	13	10	210	2	90	174383	SNC-32	
40	16	40	12	25	16	12	248.5	2	120	174384	SNC-40	
63	21	51	16	32	21	16	304	2	320	174386	SNC-63	

Swivel flange SNCS

Materials:
Die-cast aluminium

Free of copper and PTFE
RoHS-compliant

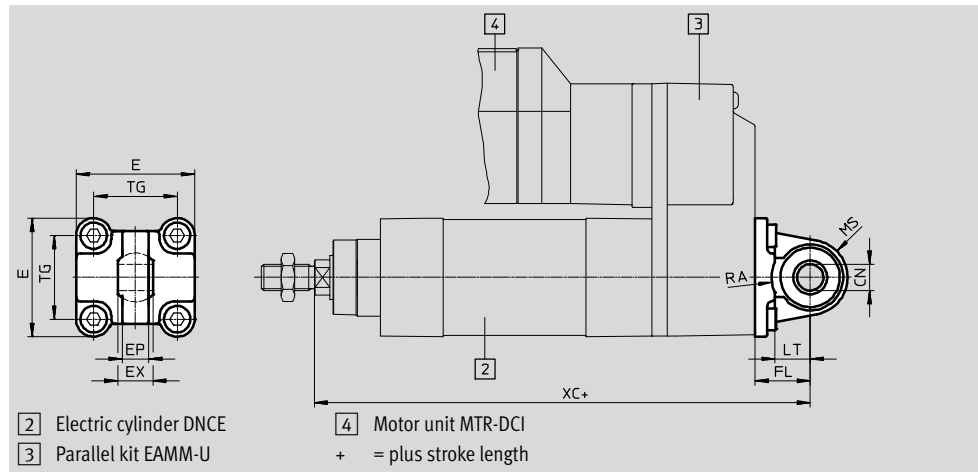

Dimensions and ordering data														
For size	CN ∅	E	EP +0.2	EX	FL ±0.2	LT	MS	RA +1	TG	XC	CRC ¹⁾	Weight [g]	Part No.	Type
[mm]														
32	10+0.013	45+0.2/-0.5	10.5	14	22	13	15+0.5	14.5	32.5	210	2	86	174397	SNCS-32
40	12+0.015	54-0.5	12	16	25	16	17+0.5	17.5	38	248.5	2	122	174398	SNCS-40
63	16+0.015	75-0.6	15	21	32	21	23-0.5	23	56.5	304	2	281	174400	SNCS-63

1) Corrosion resistance class CRC 2 to Festo standard FN 940070
Moderate corrosion stress. Indoor applications in which condensation may occur. External visible parts with primarily decorative requirements for the surface and which are in direct contact with the ambient atmosphere typical for industrial applications.

Electric cylinders DNCE, with spindle drive

Accessories

Swivel flange SNCL

Materials:
Die-cast aluminium

Free of copper and PTFE
RoHS-compliant

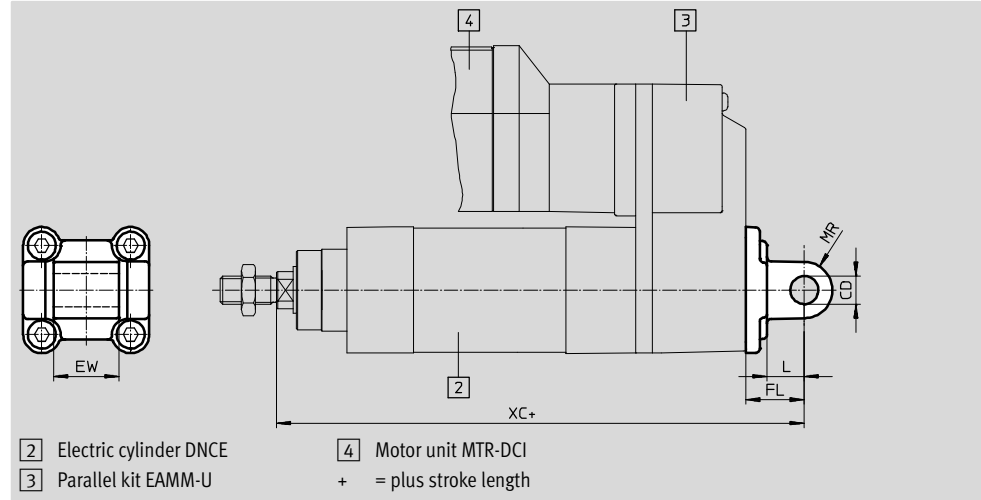

Dimensions and ordering data										
For size	CD ∅	EW	FL	L	MR	XC	CRC ¹⁾	Weight	Part No.	Type
[mm]	H9	H12	±0.2					[g]		
32	10	26	22	13	10	210	2	75	174404	SNCL-32
40	12	28	25	16	12	248.5	2	100	174405	SNCL-40
63	16	40	32	21	16	304	2	250	174407	SNCL-63

1) Corrosion resistance class CRC 2 to Festo standard FN 940070
Moderate corrosion stress. Indoor applications in which condensation may occur. External visible parts with primarily decorative requirements for the surface and which are in direct contact with the ambient atmosphere typical for industrial applications.

Electric cylinders DNCE, with spindle drive

Accessories



Swivel flange
SNCB/SNCB-...-R3

Materials:
SNCB: Die-cast aluminium
SNCB-...-R3: Die-cast aluminium with protective coating, high corrosion protection

Free of copper and PTFE
RoHS-compliant

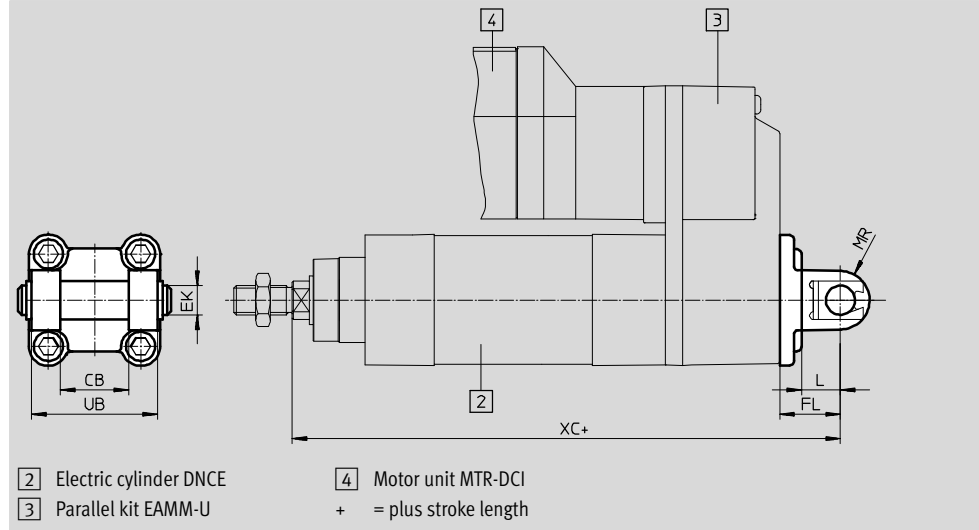

Dimensions and ordering data							
For size	CB	EK	FL	L	MR	UB	XC
[mm]	H14	∅ e8	±0.2			H14	
32	26	10	22	13	10	45	210
40	28	12	25	16	12	52	248.5
63	40	16	32	21	16	70	304

For size [mm]	Basic version				Variant R3 – High corrosion protection			
	CRC ¹⁾	Weight [g]	Part No.	Type	CRC ¹⁾	Weight [g]	Part No.	Type
32	2	103	174390	SNCB-32	3	100	176944	SNCB-32-R3
40	2	155	174391	SNCB-40	3	151	176945	SNCB-40-R3
63	2	375	174393	SNCB-63	3	371	176947	SNCB-63-R3

1) Corrosion resistance class CRC 2 to Festo standard FN 940070
Moderate corrosion stress. Indoor applications in which condensation may occur. External visible parts with primarily decorative requirements for the surface and which are in direct contact with the ambient atmosphere typical for industrial applications.
Corrosion resistance class CRC 3 to Festo standard FN 940070
High corrosion stress. Outdoor exposure under moderate corrosive conditions. External visible parts with primarily functional requirements for the surface and which are in direct contact with a normal industrial environment.

Electric cylinders DNCE, with spindle drive

Accessories

Trunnion mounting kit DAMT

Materials:
Galvanised steel
Free of copper and PTFE

The kit can be mounted at any position along the cylinder profile barrel.
The trunnion mounting kit cannot be

mounted in the vicinity of the motor when used in combination with the parallel kit EAMM-U.

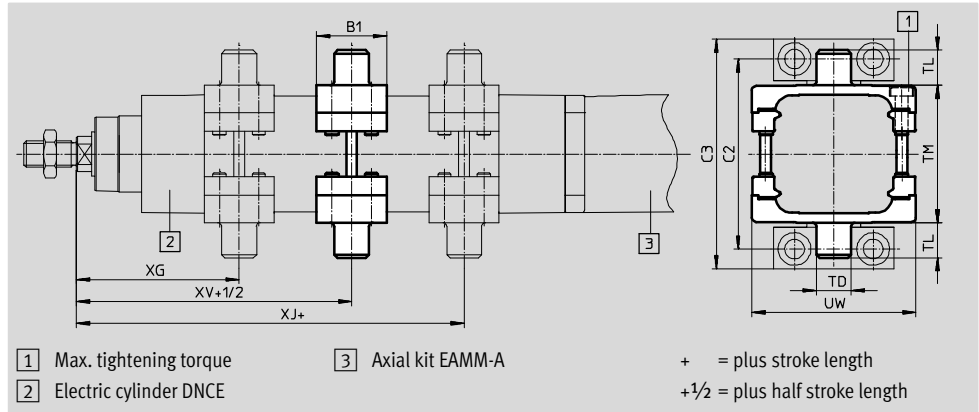

Dimensions and ordering data								
For size	B1	C2	C3	TD ∅ e9	TL	TM	UW	XG
[mm]								
32	30	71	86	12	12	50	65	65
40	32	87	105	16	16	63	75	74.5
63	41	116	136	20	20	90	105	91.5

For size	XJ	XV	Max. tightening torque [Nm]	CRC ¹⁾	Weight [g]	Part No.	Type
[mm]							
32	107	86	4+1	1	213	2213233	DAMT-V1-32-A
40	130.5	102.5	8+1	1	388	2214899	DAMT-V1-40-A
63	157.5	124.5	18+2	1	911	2214971	DAMT-V1-63-A

1) Corrosion resistance class CRC 1 to Festo standard FN 940070
Low corrosion stress. For dry indoor applications or transport and storage protection. Also applies to parts behind covers, in the non-visible interior area, and parts which are covered in the application (e.g. drive trunnions).





Ordering data – Mounting attachments				Technical data → Internet: clevis foot			
Designation	For size	Part No.	Type	Designation	For size	Part No.	Type
Clevis foot LNG				Clevis foot LSN			
	32	33890	LNG-32		32	5561	LSN-32
	40	33891	LNG-40		40	5562	LSN-40
	63	33893	LNG-63		63	5564	LSN-63
Clevis foot LSNG				Clevis foot LSNSG			
	32	31740	LSNG-32		32	31747	LSNSG-32
	40	31741	LSNG-40		40	31748	LSNSG-40
	63	31743	LSNG-63		63	31750	LSNSG-63
Clevis foot LBG				Right-angle clevis foot LQG			
	32	31761	LBG-32		32	31768	LQG-32
	40	31762	LBG-40		40	31769	LQG-40
	63	31764	LBG-63		63	31771	LQG-63

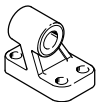

Electric cylinders DNCE, with spindle drive

Accessories

FESTO

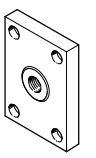
Ordering data – Mounting components, corrosion-resistant			Technical data → Internet: clevis foot	
Designation	For size	Part No.	Type	
Clevis foot CRLNG				
	32	161840	CRLNG-32	
	40	161841	CRLNG-40	
	63	161843	CRLNG-63	

Ordering data – Piston-rod attachments				Technical data → Internet: piston-rod attachment			
Designation	For size	Part No.	Type	Designation	For size	Part No.	Type
Rod eye SGS				Rod clevis SGA			
	32	9261	SGS-M10x1,25		32	32954	SGA-M10x1,25
	40	9262	SGS-M12x1,25		40	10767	SGA-M12x1,25
	63	9263	SGS-M16x1,5		63	10768	SGA-M16x1,5
Rod clevis SG				Self-aligning rod coupler FK			
	32	6144	SG-M10x1,25		32	6140	FK-M10x1,25
	40	6145	SG-M12x1,25		40	6141	FK-M12x1,25
	63	6146	SG-M16x1,5		63	6142	FK-M16x1,5
Coupling piece KSZ							
	32	36125	KSZ-M10x1,25				
	40	36126	KSZ-M12x1,25				
	63	36127	KSZ-M16x1,5				

Ordering data – Piston-rod attachments, corrosion-resistant				Technical data → Internet: piston-rod attachment			
Designation	For size	Part No.	Type	Designation	For size	Part No.	Type
Rod eye CRSGS				Rod clevis CRSG			
	32	195582	CRSGS-M10x1,25		32	13569	CRSG-M10x1,25
	40	195583	CRSGS-M12x1,25		40	13570	CRSG-M12x1,25
	63	195584	CRSGS-M16x1,5		63	13571	CRSG-M16x1,5
Self-aligning rod coupler CRFK							
	32	2305778	CRFK-M10x1,25				
	40	2305779	CRFK-M12x1,25				
	63	2490673	CRFK-M16x1,5				

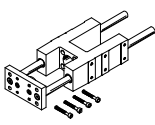
Ordering data – Guide units for fixed strokes (recirculating ball bearing guide only)				Technical data → Internet: feng		
	Stroke [mm]	Part No.	Type	Stroke [mm]	Part No.	Type
	For size 32			For size 40		
	10 ... 100	34494	FENG-32-100-KF	10 ... 100	34500	FENG-40-100-KF
	10 ... 200	34496	FENG-32-200-KF	10 ... 200	34502	FENG-40-200-KF
	10 ... 320	34497	FENG-32-320-KF	10 ... 320	34504	FENG-40-320-KF
	10 ... 400	150290	FENG-32-400-KF	10 ... 400	150291	FENG-40-400-KF
	10 ... 500	34498	FENG-32-500-KF	10 ... 500	34505	FENG-40-500-KF
	For size 63					
	10 ... 100	34514	FENG-63-100-KF			
	10 ... 200	34516	FENG-63-200-KF			
	10 ... 320	34518	FENG-63-320-KF			
	10 ... 400	34519	FENG-63-400-KF			
	10 ... 500	34520	FENG-63-500-KF			

Electric cylinders DNCE, with spindle drive

Accessories

FESTO

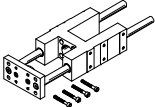
Ordering data – Guide units for variable strokes					Technical data → Internet: feng	
	For size [mm]	Stroke [mm]	With recirculating ball bearing guide		With plain-bearing guide	
			Part No.	Type	Part No.	Type
	32	10 ... 500	34487	FENG-32-...-KF	34481	FENG-32-...
	40	10 ... 500	34488	FENG-40-...-KF	34482	FENG-40-...
	63	10 ... 500	34490	FENG-63-...-KF	34484	FENG-63-...



Ordering data – Compensating components in combination with guide unit FENG			
Designation	For size	Part No.	Type
	32	570305	EADC-V1-32
	40	570306	EADC-V1-40
	63	570307	EADC-V1-50/63

Permissible proximity sensors in combination with motor units MTR-DCI

Ordering data – Proximity sensor for T-slot, magneto-resistive					Technical data → Internet: smt	
	Type of mounting	Switching output	Electrical connection	Cable length [m]	Part No.	Type
N/O contact						
	Insertable in the slot from above, flush with the cylinder profile, short design	PNP	Plug connector M8x1, 3-pin	0.3	574334	SMT-8M-A-PS-24V-E-0,3-M8D

Permissible proximity sensors in combination with servo motors EMMS-AS, stepper motors EMMS-ST or guide units FENG

Ordering data – Proximity sensor for T-slot, magneto-resistive					Technical data → Internet: smt	
	Type of mounting	Switching output	Electrical connection	Cable length [m]	Part No.	Type
N/O contact						
	Insertable in the slot from above, flush with the cylinder profile, short design	PNP	Cable, 3-wire	2.5	574335	SMT-8M-A-PS-24V-E-2,5-OE

Ordering data – Proximity sensors for T-slot, magnetic reed					Technical data → Internet: sme	
	Type of mounting	Switching output	Electrical connection	Cable length [m]	Part No.	Type
N/O contact						
	Inserted in the slot from above, flush with the cylinder profile	Contacting	Cable, 3-wire	2.5	543862	SME-8M-DS-24V-K-2,5-OE
				5.0	543863	SME-8M-DS-24V-K-5,0-OE
	Insertable in the slot lengthwise, flush with the cylinder profile	Contacting	Cable, 3-wire	2.5	150855	SME-8-K-LED-24

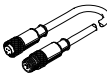
Ordering data – Connecting cable				Technical data → Internet: km8	
	Assembly	Connection	Cable length [m]	Part No.	Type
Straight socket					
	Union nut M8, both ends	3-pin	0.5	175488	KM8-M8-GSGD-0,5
			1	175489	KM8-M8-GSGD-1
			2.5	165610	KM8-M8-GSGD-2,5
			5	165611	KM8-M8-GSGD-5

Ordering data – Slot cover for T-slot				
	Mounting	Length	Part No.	Type
	Insertable	2x 0.5 m	151680	ABP-5-S