

Linear actuators DLP, Copac





# Linear actuators DLP, Copac

Key features and type codes



## General

-  - Diameter  
80 ... 320 mm
-  - Stroke length  
40 ... 600 mm
-  - Force  
2,800 ... 48,000 N

Festo Copac linear valve actuators are ideally suited for use in water, sewage, industrial process water and silage technology, as well as the paper and bulk goods industry. A clean solution for shut-off, safety and control slide valves. The Copac linear actuator acts directly upon the slide plate and facilitates accurate advancing to various positions.

- Fast or slow valve actuation
- Position sensing
- Internal air channels eliminate protruding tubing and attachments, and thus also harmful accumulation of contaminants
- Suitable for manual on-site use, as well as automatic operation
- Opening and closing actuated via flange-mounted solenoid valve with port pattern to Namur, or via valve terminals with a choice of 30 different fieldbus protocols
- Sturdy and reliable, even in aggressive environments
- Highly corrosion resistant
- Mounting port pattern to DIN 3358/ISO 5210 for direct mounting
- Port pattern to Namur VDI/VDE 3845 for attaching solenoid valves



		DLP	–	100	–	125	–	A
<b>Type</b>								
DLP	Double-acting linear actuator							
<b>Piston Ø [mm]</b>								
<b>Stroke [mm]</b>								
<b>Position sensing</b>								
A	Via proximity sensor							

# Linear actuators DLP, Copac

Peripherals overview

FESTO

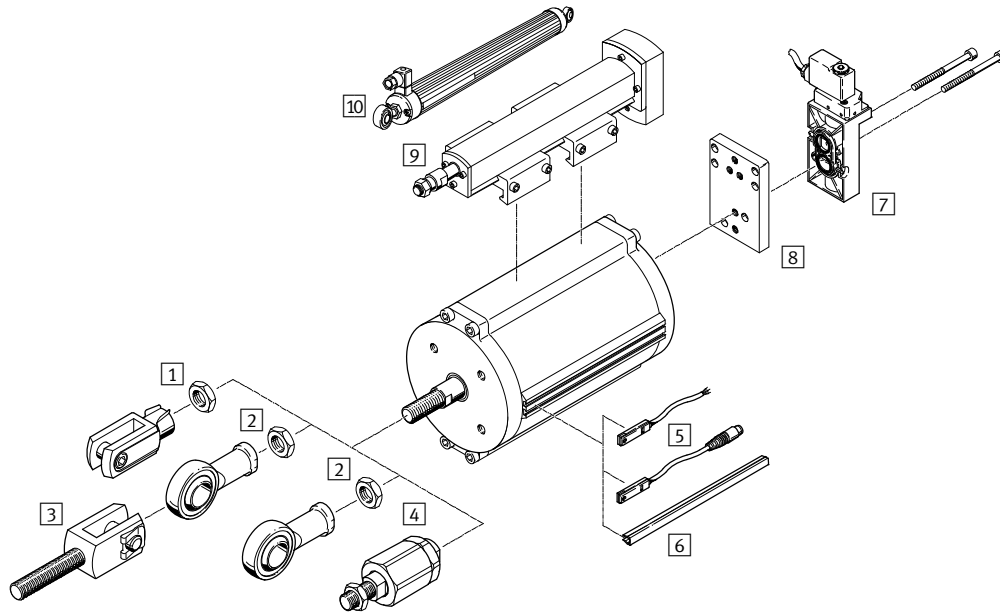



Mounting attachments and accessories						
	Brief description	DLP-80/100	DLP-125/160	DLP-200 ... 320	→ Page/Internet	
1	Rod clevis SG	■	■	■	9	
	Rod clevis, stainless steel CRSG	■	■	-	9	
2	Rod eye SGS	■	■	■	9	
	Rod eye, stainless steel CRSGS	■	■	-	9	
3	Rod clevis SGA	■	■	■	9	
4	Self-aligning rod coupler FK/CRFK	■	■	■	9	
5	Proximity sensor SMT-8F-I	■	■	■	10	
	Proximity sensor SMT-8	■	■	■	10	
	Proximity sensor SME-8	■	■	■	10	
6	Slot cover ABP-5-S	■	■	■	11	
7	Solenoid valve	■	■	■	solenoid valve	
8	Sub-base DLP-VSE-OBEN-NAMUR	■	■	■	dlp-vse	
9	Measuring unit ASDLP	■	■	-	asdlp	
10	Displacement encoder MLO-POT	■	■	■	mlo-pot	

# Linear actuators DLP, Copac

## Technical data

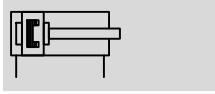
### Function



-  - Diameter  
80 ... 320 mm

-  - Stroke length  
40 ... 600 mm

-  - Force  
2,800 ... 48,000 N



General technical data							
Piston $\varnothing$	80	100	125	160	200	250	320
Pneumatic connection	G $\frac{1}{4}$						
Based on standard	DIN 3358						
Valve connection conforms to	VDI/VDE 3845 (NAMUR)						
Design	Piston cylinder, double-acting						
Cushioning	None						
Stroke reserve [mm]	2				4		
Assembly position	Any						
Position sensing	Via proximity sensor						
Efficiency actuator [%]	95						

Operating and environmental conditions		
Operating pressure <sup>1)</sup> [bar]	2 ... 10	
Nominal operating pressure [bar]	6	
Operating medium	Compressed air in accordance with ISO 8573-1:2010 [7:4:4]	
Note on operating/pilot medium	Operation with lubricated medium possible (in which case lubricated operation will always be required)	
Ambient temperature <sup>2)3)</sup> [°C]	-20 ... +80	
Corrosion resistance class CRC <sup>4)</sup>	3	
CE marking (see declaration of conformity) → <a href="http://www.festo.com">www.festo.com</a>	To EU Explosion Protection Directive (ATEX)	
ATEX category gas	II 2G	
Ex-ignition protection type gas	c T4	
ATEX category dust	II 2D	
EX-ignition protection type dust	c 120°C	
ATEX ambient temperature <sup>3)</sup>	-20°C ≤ Ta ≤ +60°C	

1) Depending upon the counter force of the valve slide, a higher minimum pressure may be required to actuate the overall system

2) Further temperature ranges upon request

3) Note operating range of proximity sensors

4) Corrosion resistance class 3 according to Festo standard 940 070

Components requiring higher corrosion resistance. External visible parts in direct contact with industrial atmospheres or media such as solvents and cleaning agents, with a predominantly functional requirement for the surface

# Linear actuators DLP, Copac

Technical data

Forces [N] and air consumption [NI]							
Piston $\varnothing$	80	100	125	160	200	250	320
Theoretical force at 6 bar, advancing	3,016	4,712	7,363	12,064	18,850	29,452	48,255
Theoretical force at 6 bar, retracting	2,827	4,524	6,881	11,581	18,080	28,698	47,501
Theoretical air consumption at 6 bar and 10 mm stroke, pushing	0.35	0.55	0.86	1.41	2.12	3.44	5.63
Theoretical air consumption at 6 bar and 10 mm stroke, pulling	0.33	0.53	0.80	1.35	2.11	3.35	5.54

Weights [g]							
Piston $\varnothing$	80	100	125	160	200	250	320
Basic weight with 0 mm stroke	1,843	2,801	4,855	5,854	12,831	21,117	33,907
Additional weight per 10 mm stroke	68	80	145	159	187	325	399
Moving load with 0 mm stroke	624	997	1,809	2,183	4,691	6,650	11,040
Additional moving load per 10 mm stroke	25	25	63	63	99	99	99

## Materials

Sectional view

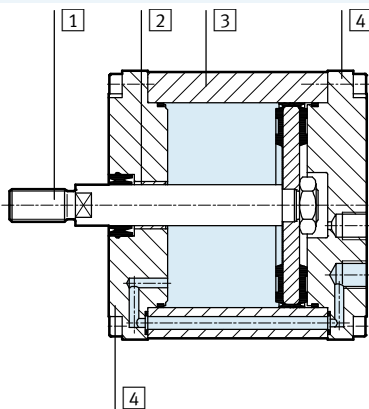

Linear actuator	
1	Piston rod High-alloy rolled steel
2	Rod bearing Smooth composite material
3	Cylinder barrel $\varnothing$ 80 ... 200 Smooth anodised aluminium
	$\varnothing$ 250, 320 Stainless steel
4	Cylinder cap Extruded aluminium
-	Seals Polyurethane, nitrile rubber

# Linear actuators DLP, Copac

Technical data

FESTO

## Dimensions

Download CAD data → [www.festo.com](http://www.festo.com)

Ø 80 ... 160

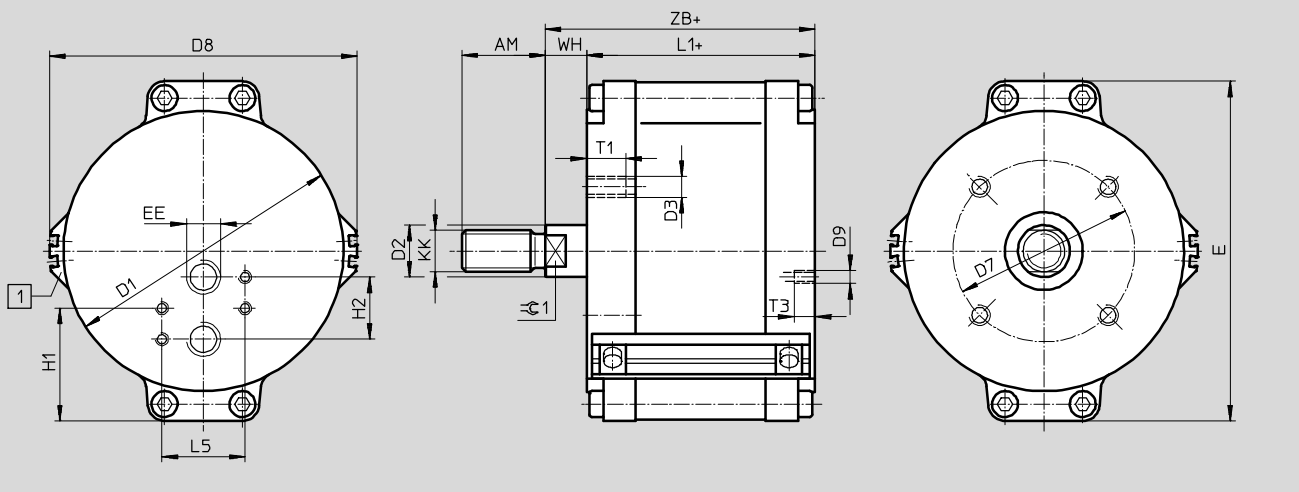

Ø 200 ... 320

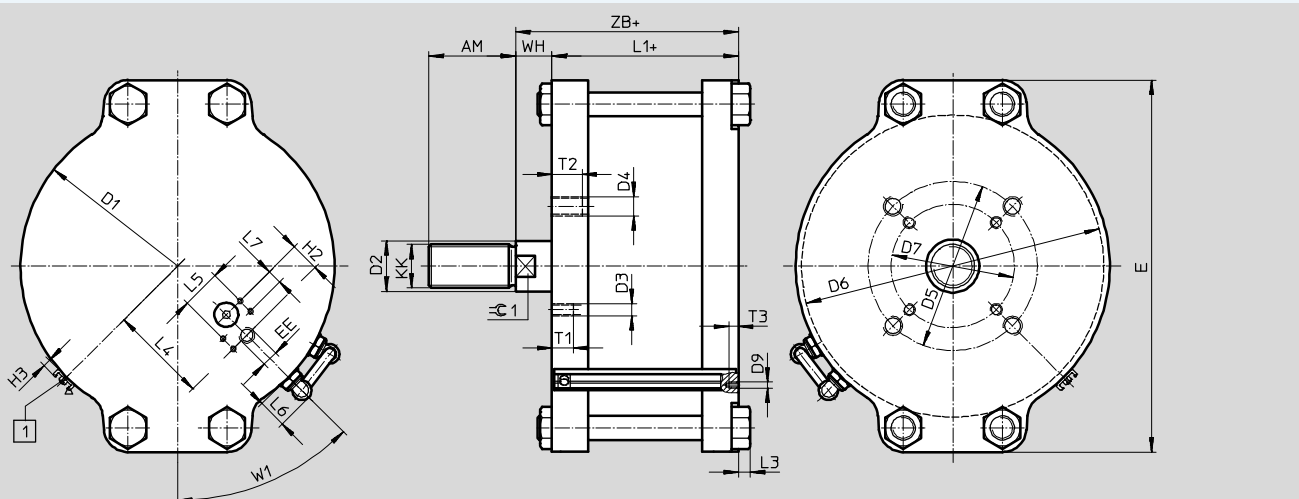

1 Mounting slots for proximity sensor SME/SMT-8

+ = plus stroke length

# Linear actuators DLP, Copac

Technical data

∅ [mm]	AM	D1 ∅	D2 ∅	D3 ∅	D4 ∅	D5 ∅	D6 ∅	D7 ∅	D8 ∅	D9 ∅	E	EE	H1	H2	H3
	-2														
DLP-80-...-A	32	87	20	M8	-	-	-	70	99	M5	108	G¼	43.5	24	-
DLP-100-...-A	32	108	20	M8	-	-	-	70	119	M5	131	G¼	43.5	24	-
DLP-125-...-A	54	135	32	M10	-	-	-	102	147	M5	163	G¼	43.5	24	-
DLP-160-...-A	54	170	32	M10	-	-	-	102	182	M5	199	G¼	43.5	24	-
DLP-200-...-A	72	216	40	M10	M16	140	210	102	-	M5	271	G¼	43.5	24	4.5
DLP-250-...-A	72	260	40	M10	M16	140	244	102	-	M5	308	G¼	43.5	24	4.5
DLP-320-...-A	72	332	40	M10	M16	140	324	102	-	M5	378	G¼	43.5	24	4.5

∅ [mm]	KK	L1	L3	L4	L5	L6	L7	T1	T2	T3	W1	WH	ZB	≅G1
DLP-80-...-A	M16x1.5	100 +1.4/-0.4	-	-	32	-	-	15	-	8	45°	16 +0.6/-1.8	116 +0.6/-0.8	16
DLP-100-...-A	M16x1.5	104 +1.4/-0.4	-	-	32	-	-	15	-	8	45°	16 +0.6/-1.8	120 +0.6/-0.8	16
DLP-125-...-A	M27x2	114 +1.6/-0.6	-	-	32	-	-	18	-	8	45°	24 +0.8/-1.8	138 +0.8/-1.0	27
DLP-160-...-A	M27x2	114 +1.6/-0.6	-	-	32	-	-	18	-	8	45°	24 +1.2/-1.8	138 +1.2/-0.8	27
DLP-200-...-A	M36x2	150 +0.8/-1.0	10	81	32	24.5	12	20	24	8	45°	30 ±1.4	180 ±1	36
DLP-250-...-A	M36x2	152 +0.8/-1.4	25	94	32	24.5	12	20	25	8	45°	30 +1.8/-1.4	182 ±1	36
DLP-320-...-A	M36x2	159 +0.8/-1.4	-	130	32	24.5	12	20	25	8	45°	30 +1.8/-1.6	189 +0.8/-1.2	36

# Linear actuators DLP, Copac

Technical data

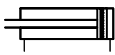
Ordering data				
Version	Piston $\varnothing$ [mm]	Stroke [mm]	Part No.	Type
With position sensing				
	80	40 ... 500	<b>187 479</b>	<b>DLP-80-...-A</b>
	100	50 ... 500	<b>187 480</b>	<b>DLP-100-...-A</b>
	125	50 ... 500	<b>187 481</b>	<b>DLP-125-...-A</b>
	160	100 ... 500	<b>187 482</b>	<b>DLP-160-...-A</b>
	200	100 ... 600	<b>542 711</b>	<b>DLP-200-...-A</b>
	250	100 ... 600	<b>187 483</b>	<b>DLP-250-...-A</b>
	320	150 ... 600	<b>187 484</b>	<b>DLP-320-...-A</b>

-  - Note

### Stroke length of the actuator





Generally, the stroke length of the Copac linear actuator corresponds to the nominal diameter of the process valve. The system tolerances may lead to a greater stroke range than the specified nominal stroke range of



the linear actuator. The zero point is set with an adjustable rod clevis. This ensures that the end position of the valve slide is reached and the zero position of the system is fixed.





# Linear actuators DLP, Copac

Accessories

Ordering data – Piston rod attachments				Technical data → Internet: piston rod attachment			
Designation	For Ø	Part No.	Type	Designation	For Ø	Part No.	Type
<b>Rod eye SGS</b>				<b>Rod clevis SG</b>			
	80, 100	9263	SGS-M16x1,5		80, 100	6146	SG-M16x1,5
	125, 160	10774	SGS-M27x2		125, 160	14987	SG-M27x2-B
	200, 250, 320	10775	SGS-M36x2		200, 250, 320	9581	SG-M36x2
<b>Rod clevis SGA</b>				<b>Self-aligning rod coupler FK</b>			
	80, 100	10768	SGA-M16x1,5		80, 100	6142	FK-M16x1,5
	125, 160	10770	SGA-M27x2		125, 160	10485	FK-M27x2
	200, 250, 320	10771	SGA-M36x2		200, 250, 320	10746	FK-M36x2

Ordering data – Piston rod attachments, corrosion-resistant				Technical data → Internet: crsg			
Designation	For Ø	Part No.	Type	Designation	For Ø	Part No.	Type
<b>Rod eye CRSG</b>				<b>Rod clevis CRSGS</b>			
	80, 100	13571	CRSG-M16x1,5		80, 100	195584	CRSGS-M16x1,5
	125, 160	185361	CRSG-M27x2		125, 160	195586	CRSGS-M27x2
<b>Self-aligning rod coupler CRFK</b>							
	80	2490673	CRFK-M16x1,5				
	100						

Ordering data – Displacement encoders			Technical data → Internet: mlo	
	Stroke [mm]	Part No.	Type	
	100	192213	MLO-POT-100-LWG	
	150	192214	MLO-POT-150-LWG	
	225	152645	MLO-POT-225-LWG	
	300	152646	MLO-POT-300-LWG	
	360	152647	MLO-POT-360-LWG	
	450	152648	MLO-POT-450-LWG	
	600	152650	MLO-POT-600-LWG	
	750	152651	MLO-POT-750-LWG	

Ordering data – Plug socket for displacement encoder			Technical data → Internet: sd-4	
	Pin	Pin allocation	Part No.	Type
	1	Power supply	194332	SD-4-WD-7
	2	Signal		
	3	0 V		
	4	PE (yellow), screened		

# Linear actuators DLP, Copac

Accessories

FESTO

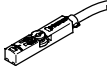
Ordering data – Proximity sensor for T-slot, magneto-resistive					Technical data → Internet: smt-8	
	Switching output	Electrical connection		Cable length [m]	Part No.	Type
		Cable	Plug M8x1			
	N/O contact					
	PNP	3-wire	–	2.5	574335	SMT-8M-A-PS-24V-E-2,5-OE
				5.0	574336	SMT-8M-A-PS-24V-E-5,0-OE
		–	3-pin	0.3	574334	SMT-8M-A-PS-24V-E-0,3-M8D
	NPN	3-wire	–	2.5	574338	SMT-8M-A-PS-24V-E-2,5-OE
				0.3	574339	SMT-8M-A-PS-24V-E-0,3-M8D

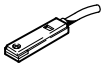
Ordering data – Proximity sensor for T-slot					Technical data → Internet: crsmt	
	Switching output	Electrical connection	Cable length [m]	Part No.	Type	
					N/O contact	
	PNP	Cable, 3-wire	2.5	525563	CRSMT-8-PS-K2,5-LED-24	
			5.0	525564	CRSMT-8-PS-K5-LED-24	

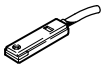

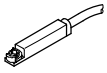
Ordering data – Proximity sensor for T-slot, magnetic reed					Technical data → Internet: sme		
	Connection technology		Cable length [m]	Part No.	Type		
	Cable	Cable with plug M8x1					
	N/O contact						
	Operating voltage range 0 ... 30 V AC/DC						
	3-wire	–	–	2.5	150855	SME-8-K-LED-24	
				5.0	175404	SME-8-K5-LED-24	
				7.5	530491	SME-8-K-7,5-LED-24	
	–	3-pin	0.3	150857	SME-8-S-LED-24		
	2-wire	–	2.5	171169	SME-8-ZS-KL-LED-24		
	Heat-resistant up to 120 °C						
	2-wire	–	2.5	161756	SME-8-K-24-S6		
	Operating voltage range 3 ... 250 V AC/DC						
	2-wire	–	2.5	152820	SME-8-K-LED-230		
	N/C contact						
	3-wire	–	7.5	160251	SME-8-0-K-LED-24		

Ordering data – Ex proximity sensors for T-slot					Technical data → Internet: smt	
	Switching output	Electrical connection	Cable length [m]	Part No.	Type	
						
	NAMUR	Cable, 2-wire	5.0	536956	SMT-8F-I-8,2V-K5,0-OE-EX	

# Linear actuators DLP, Copac

Accessories

**FESTO**

Ordering data – Connecting cable M8x1						Technical data → Internet: nebu	
	Electrical connection, left	Electrical connection, right	Switching output	Cable length [m]	Part No.	Type	
<b>Basic version</b>							
	Straight socket, M8x1, 3-pin	Cable, open end, 3-wire	–	2.5	<b>541333</b>	<b>NEBU-M8G3-K-2.5-LE3</b>	
				5	<b>541334</b>	<b>NEBU-M8G3-K-5-LE3</b>	
				10	<b>541332</b>	<b>NEBU-M8G3-K-10-LE3</b>	
	Angled socket, M8x1, 3-pin	Cable, open end, 3-wire	–	2.5	<b>541338</b>	<b>NEBU-M8W3-K-2.5-LE3</b>	
				5	<b>541341</b>	<b>NEBU-M8W3-K-5-LE3</b>	
				10	<b>541335</b>	<b>NEBU-M8W3-K-10-LE3</b>	
<b>With switching status display</b>							
	Angled socket, M8x1, 3-pin	Cable, open end, 3-wire	PNP	2.5	<b>541337</b>	<b>NEBU-M8W5P-K-2.5-LE3</b>	
				5	<b>541340</b>	<b>NEBU-M8W5P-K-5-LE3</b>	
			NPN	2.5	<b>541336</b>	<b>NEBU-M8W5N-K-2.5-LE3</b>	
				5	<b>541339</b>	<b>NEBU-M8W5N-K-5-LE3</b>	

Ordering data – Slot cover for T-slot			
	Assembly	Length [m]	Part No. Type
	Insertable from above	2x 0.5	<b>151680</b> <b>ABP-5-S</b>

Ordering data – Cable clip SMBK-8		
		Part No. Type
	For fixing the cable in the sensor slot	<b>534254</b> <b>SMBK-8</b>

Ordering data – Inscription labels						
	Material	Usage	Dimensions [mm]	Part No.	Type	PU <sup>1)</sup>
	Polycarbonate	For insertion in the inscription label holder	23x4	<b>541598</b>	<b>ASLR-L-423</b>	<b>34</b>

1) Packaging unit per frame