



- Easy to insert
- Easy to release
- Up to 6 outlets
- 360° rotatable

# Multiple distributors QS, Quick Star

Key features

FESTO

Simply "plug and work"	Reliably connected	Captive seal	Orientable
------------------------	--------------------	--------------	------------



The stainless steel retaining claw within the fitting holds the tubing securely without damaging its surface. Vibration and pressure surges are safely absorbed. The tubing can be detached easily by pressing down the blue release ring. For your convenience, the appropriate outside tubing diameter is marked on the release ring.



A nitrile rubber sealing ring guarantees a perfect seal between standard OD tubing and the body of the fitting. Standard tubing is suitable for use with compressed air and vacuum.

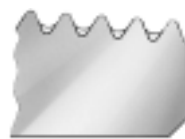

All brass parts of Festo's push-in fittings are nickel plated and are thus highly resistant to corrosion. The tapered ISO R threads have a self-sealing PTFE coating, which allows the fitting to be re-used up to five times without the need for additional sealing components.



The fitting can be aligned after assembly.

## Which fitting fits which thread?

### G thread to ISO 228-1

- Shorter thread
- Constant installation depth
- Replaceable sealing ring
- Sealing at front
- Can be re-used a number of times thanks to replaceable sealing ring

### R thread to EN 10226-1 and ISO 7/1

- Self-sealing thread
- Sealing on the threads
- No additional sealing surface required
- Smaller installation dimensions since there is no need for a rebate for the sealing surface
- Can be re-used up to five times

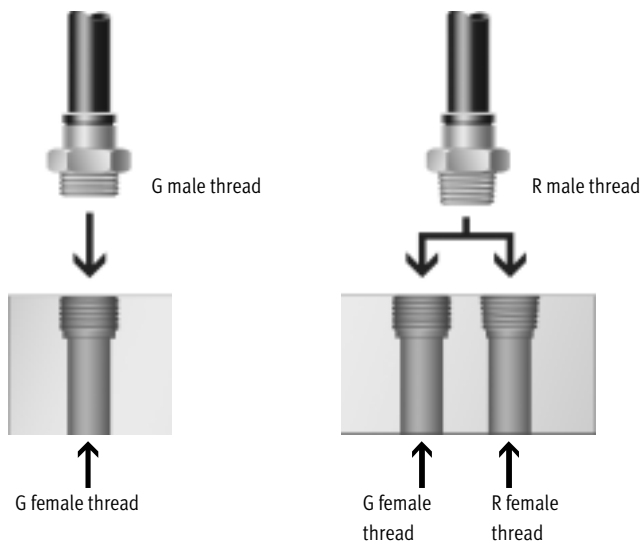

# Multiple distributors QS, Quick Star

Technical data

FESTO

General technical data	
Size	Standard
Design structure	Push/pull principle
Assembly position	Any
Type of seal on threaded plug	Sealing ring (G thread) Coating (R thread)

Operating and environmental conditions	
Operating pressure [bar]	-0.95 ... +6
complete temperature range	
Temperature dependent operating pressure [bar]	-0.95 ... +14 → diagram
Operating medium	Compressed air in accordance with ISO 8573-1:2010 [7:-:-] Water as per manufacturer's declaration <sup>1)</sup>
Note on operating/pilot medium	Operation with lubricated medium possible
Ambient temperature [°C]	-10 ... +80
Corrosion resistance class CRC <sup>2)</sup>	1
Certification	Germanischer Lloyd

1) Additional information [www.festo.com/sp](http://www.festo.com/sp) → User documentation.

2) Corrosion resistance class CRC 1 to Festo standard FN 940070

Low corrosion stress. For dry indoor applications or transport and storage protection. Also applies to parts behind covers, in the non-visible interior area, and parts which are covered in the application (e.g. drive trunnions).

## Operating pressure p as a function of temperature t

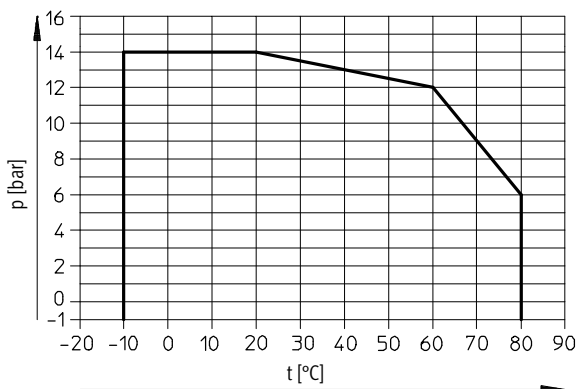

## Materials

Sectional view

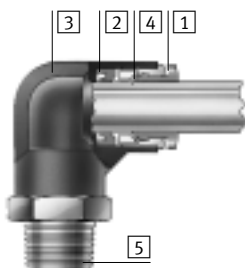

Multiple distributor		
1	Release ring	POM (colour: blue)
2	Seal	NBR
3	Housing	PBT
4	Tube clamping segment	High alloy stainless steel
5	Threaded coupling	Nickel plated brass
Note on materials		RoHS-compliant

# Multiple distributors QS, Quick Star

Technical data

Tightening torque	
Connecting thread	Nominal tightening torque [Nm]
G thread	
G $\frac{1}{8}$	7 ±20%
G $\frac{1}{4}$	9 ±20%
G $\frac{3}{8}$	15.5 ±20%
G $\frac{1}{2}$	26 ±20%

Tubing insertion depth						
	Tubing O.D. [mm]	4	6	8	10	12
	Tubing insertion depth [mm]		15	17	18	20.5









Possible push-in fitting/tubing combinations					
Thread	Tubing O.D. [mm]				
	4	6	8	10	12
R $\frac{1}{8}$	+	++	+	-	-
R $\frac{1}{4}$	+	+	++	+	-
R $\frac{3}{8}$	-	-	+	++	+
R $\frac{1}{2}$	-	-	-	-	++
G $\frac{1}{8}$	+	++	+	-	-
G $\frac{1}{4}$	+	+	++	+	-
G $\frac{3}{8}$	-	-	+	++	+
G $\frac{1}{2}$	-	-	-	-	++

- + Possible thread/tubing O.D. combinations
- ++ Optimum thread/tubing O.D. combinations (with regard to flow)

# Multiple distributors QS, Quick Star

Product range overview

FESTO

Shape	Design	Type	Connection D1			Connection D2	Connection D3	→ Page/ Internet
			R thread	G thread	Tubing O.D.	Tubing O.D.	Tubing O.D.	
L-shape	<b>Multiple distributor, 2 outlets</b>							
		QSLV2	R 1/8	G 1/8	-	4, 6, 8	-	6
			R 1/4	G 1/4		6, 8, 10		
			R 3/8	G 3/8		8, 10, 12		
			R 1/2	G 1/2		12		
	<b>Multiple distributor, 3 outlets</b>							
		QSLV3	R 1/8	G 1/8	-	4, 6, 8	-	7
			R 1/4	G 1/4		6, 8, 10		
			R 3/8	G 3/8		8, 10, 12		
			R 1/2	G 1/2		12		
	<b>Multiple distributor, 4 outlets</b>							
		QSLV4	R 1/8	G 1/8	-	4, 6, 8	-	8
			R 1/4	G 1/4		6, 8, 10		
			R 3/8	G 3/8		8, 10, 12		
			R 1/2	G 1/2		12		
<b>Multiple distributor, 6 outlets</b>								
	QSLV6	R 1/8	G 1/8	-	4, 6, 8	-	9	
		R 1/4	G 1/4		6, 8, 10			
		R 3/8	G 3/8		8, 10, 12			
		R 1/2	G 1/2		12			
<b>Multiple distributor, 4 outlets</b>								
	QSQ	R 1/8	G 1/8	-	4, 6	-	10	
		R 1/4	G 1/4		4, 6			
	QSQ	-	-	6	4	-	10	
		-	-	8	6			
T-shape	<b>Multiple distributor, 4 outlets</b>							
		QST3	R 1/8	G 1/8	-	6	4	11
			R 1/4	G 1/4		8	6	
			R 3/8	G 3/8		10	8	
		QST3	-	-	6	6	4	11
			-	-	8	8	6	
-			-	10	10	8		

# Multiple distributors QSLV2, Quick Star

Technical data

FESTO

## Multiple distributor QSLV2

No. of supply lines: 1

No. of outlets: 2



R thread

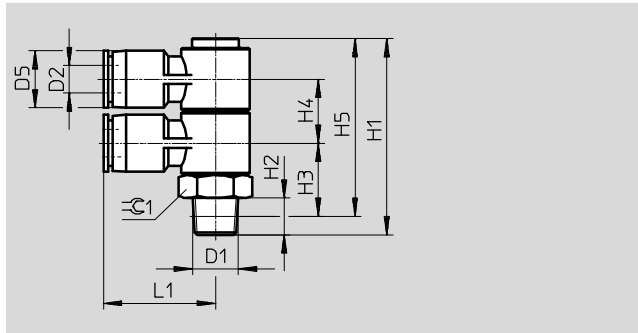

G thread

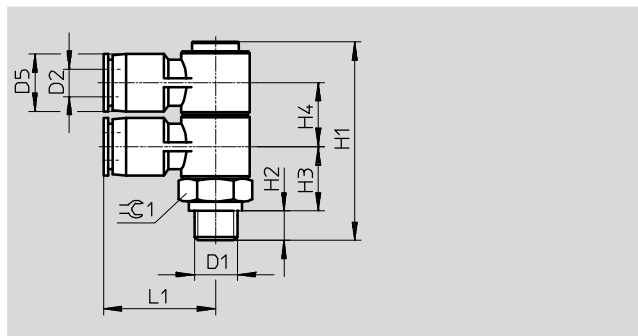

Dimensions and ordering data														
Connection	Nominal size [mm]	Tubing O.D. D2	D5 Ø	H1	H2	H3	H4	H5	L1	⌀C1	Weight/ piece [g]	Part No.	Type	PU*
<b>R thread</b>														
R $\frac{1}{8}$	2.4	4	10	41.6	8	15.5	13	37.6	22.2	14	26	153211	QSLV2- $\frac{1}{8}$ -4	1
	3.2	6	12.5	41.6	8	15.5	13	37.6	24.2	14	28	153212	QSLV2- $\frac{1}{8}$ -6	1
	4.2	8	14.5	46.6	8	17.5	15	42.6	27.7	17	44	153214	QSLV2- $\frac{1}{8}$ -8	1
R $\frac{1}{4}$	3.2	6	12.5	44.6	11	16.5	13	38.6	24.2	14	34	153213	QSLV2- $\frac{1}{4}$ -6	1
	4.3	8	14.5	49.6	11	18.5	15	43.6	27.7	17	47	153215	QSLV2- $\frac{1}{4}$ -8	1
	5.2	10	17.5	57.6	11	22	18	51.6	31.7	22	80	153217	QSLV2- $\frac{1}{4}$ -10	1
R $\frac{3}{8}$	4.3	8	14.5	50.6	12	19.2	15	44.3	27.7	17	54	153216	QSLV2- $\frac{3}{8}$ -8	1
	5.3	10	17.5	58.6	12	22.7	18	52.3	31.7	22	83	153218	QSLV2- $\frac{3}{8}$ -10	1
	6.3	12	21	68.8	12	27.5	21.6	62.5	36.7	27	139	153219	QSLV2- $\frac{3}{8}$ -12	1
R $\frac{1}{2}$	6.4	12	21	71.8	15	28.6	21.6	63.6	36.7	27	149	153220	QSLV2- $\frac{1}{2}$ -12	1
<b>G thread with sealing ring</b>														
G $\frac{1}{8}$	2.4	4	10	40.6	5.1	13.4	13	-	22.2	14	25	186223	QSLV2-G $\frac{1}{8}$ -4	1
	3.2	6	12.5	40.6	5.1	13.4	13	-	24.2	14	27	186224	QSLV2-G $\frac{1}{8}$ -6	1
	4.2	8	14.5	45.6	5.1	15.4	15	-	27.7	17	43	186226	QSLV2-G $\frac{1}{8}$ -8	1
G $\frac{1}{4}$	3.2	6	12.5	42.1	5.6	14.4	13	-	24.2	17	36	186225	QSLV2-G $\frac{1}{4}$ -6	1
	4.3	8	14.5	46.1	5.6	15.4	15	-	27.7	17	44	186227	QSLV2-G $\frac{1}{4}$ -8	1
	5.2	10	17.5	54.1	5.6	18.9	18	-	31.7	22	77	186229	QSLV2-G $\frac{1}{4}$ -10	1
G $\frac{3}{8}$	4.3	8	14.5	47.6	6.6	15.9	15	-	27.7	19	53	186228	QSLV2-G $\frac{3}{8}$ -8	1
	5.3	10	17.5	55.6	6.6	19.4	18	-	31.7	22	79	186230	QSLV2-G $\frac{3}{8}$ -10	1
	6.3	12	21	65.8	6.6	24.2	21.6	-	36.7	27	135	186231	QSLV2-G $\frac{3}{8}$ -12	1
G $\frac{1}{2}$	6.4	12	21	66.8	7.6	24.2	21.6	-	36.7	27	140	186232	QSLV2-G $\frac{1}{2}$ -12	1

\* Packaging unit quantity

# Multiple distributors QSLV3, Quick Star

Technical data

## Multiple distributor QSLV3

No. of supply lines: 1

No. of outlets: 3

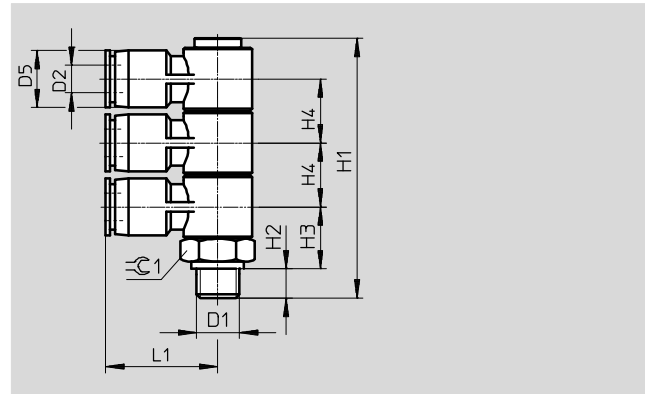
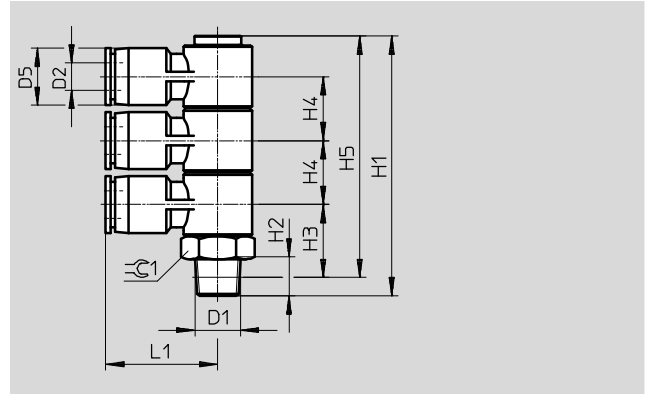

Dimensions and ordering data														
Connection	Nominal size [mm]	Tubing O.D. D2	D5 Ø	H1	H2	H3	H4	H5	L1	≈C1	Weight/ piece [g]	Part No.	Type	PU*
<b>R thread</b>														
R $\frac{1}{8}$	2.4	4	10	54.7	8	15.5	13	50.7	22.2	14	33	153221	QSLV3- $\frac{1}{8}$ -4	1
	3.2	6	12.5	54.7	8	15.5	13	50.7	24.2	14	35	153222	QSLV3- $\frac{1}{8}$ -6	1
	4.3	8	14.5	61.7	8	17.5	15	57.7	27.7	17	56	153224	QSLV3- $\frac{1}{8}$ -8	1
R $\frac{1}{4}$	3.2	6	12.5	57.7	11	16.5	13	51.7	24.2	14	41	153223	QSLV3- $\frac{1}{4}$ -6	1
	4.2	8	14.5	64.7	11	18.5	15	58.7	27.7	17	59	153225	QSLV3- $\frac{1}{4}$ -8	1
	5.2	10	17.5	75.7	11	22	18	69.7	31.7	22	99	153227	QSLV3- $\frac{1}{4}$ -10	1
R $\frac{3}{8}$	4.3	8	14.5	65.7	12	19.2	15	59.4	27.7	17	66	153226	QSLV3- $\frac{3}{8}$ -8	1
	5.3	10	17.5	76.7	12	22.7	18	70.4	31.7	22	102	153228	QSLV3- $\frac{3}{8}$ -10	1
	6.4	12	21	90.5	12	27.5	21.6	84.2	36.7	27	171	153229	QSLV3- $\frac{3}{8}$ -12	1
R $\frac{1}{2}$	6.5	12	21	93.5	15	28.6	21.6	85.3	36.7	27	180	153230	QSLV3- $\frac{1}{2}$ -12	1
<b>G thread with sealing ring</b>														
G $\frac{1}{8}$	2.4	4	10	53.7	5.1	13.4	13	-	22.2	14	32	186233	QSLV3-G $\frac{1}{8}$ -4	1
	3.2	6	12.5	53.7	5.1	13.4	13	-	24.2	14	35	186234	QSLV3-G $\frac{1}{8}$ -6	1
	4.3	8	14.5	60.7	5.1	15.4	15	-	27.7	17	55	186236	QSLV3-G $\frac{1}{8}$ -8	1
G $\frac{1}{4}$	3.2	6	12.5	55.2	5.6	14.4	13	-	24.2	17	43	186235	QSLV3-G $\frac{1}{4}$ -6	1
	4.2	8	14.5	61.2	5.6	15.4	15	-	27.7	17	56	186237	QSLV3-G $\frac{1}{4}$ -8	1
	5.2	10	17.5	72.2	5.6	18.9	18	-	31.7	22	96	186239	QSLV3-G $\frac{1}{4}$ -10	1
G $\frac{3}{8}$	4.3	8	14.5	62.7	6.6	15.9	15	-	27.7	19	65	186238	QSLV3-G $\frac{3}{8}$ -8	1
	5.3	10	17.5	73.3	6.6	19.4	18	-	31.7	22	98	186240	QSLV3-G $\frac{3}{8}$ -10	1
	6.4	12	21	87.5	6.6	24.2	21.6	-	36.7	27	167	186241	QSLV3-G $\frac{3}{8}$ -12	1
G $\frac{1}{2}$	6.5	12	21	88.5	7.6	24.2	21.6	-	36.7	27	171	186242	QSLV3-G $\frac{1}{2}$ -12	1

\* Packaging unit quantity

# Multiple distributors QSLV4, Quick Star

Technical data

FESTO

## Multiple distributor QSLV4

No. of supply lines: 1

No. of outlets: 4

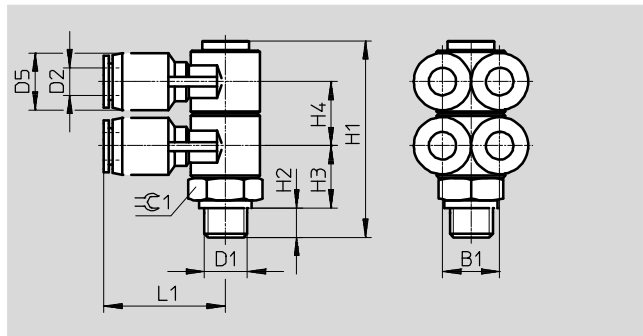
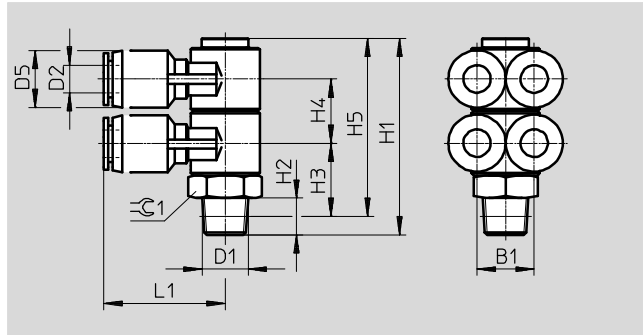

Dimensions and ordering data															
Connection	Nominal size [mm]	Tubing O.D. D2	D5 Ø	H1	H2	H3	H4	H5	L1	B1	⌀C1	Weight/ piece [g]	Part No.	Type	PU*
<b>R thread</b>															
R $\frac{1}{8}$	2.3	4	10	41.6	8	15.5	13	37.6	22.2	10	14	31	153231	QSLV4- $\frac{1}{8}$ -4	1
	2.9	6	12.5	41.6	8	15.5	13	37.6	24.2	12	14	35	153232	QSLV4- $\frac{1}{8}$ -6	1
	4	8	14.5	46.6	8	17.5	15	42.6	27.7	14	17	54	153234	QSLV4- $\frac{1}{8}$ -8	1
R $\frac{1}{4}$	2.9	6	12.5	44.6	11	16.5	13	38.6	24.2	12	14	40	153233	QSLV4- $\frac{1}{4}$ -6	1
	4.1	8	14.5	49.6	11	18.5	15	43.6	27.7	14	17	56	153235	QSLV4- $\frac{1}{4}$ -8	1
	5	10	17.5	57.6	11	22	18	51.6	31.7	17	22	95	153237	QSLV4- $\frac{1}{4}$ -10	1
R $\frac{3}{8}$	4.1	8	14.5	50.6	12	19.2	15	44.3	27.7	14	17	64	153236	QSLV4- $\frac{3}{8}$ -8	1
	5.1	10	17.5	58.6	12	22.7	18	52.3	31.7	17	22	98	153238	QSLV4- $\frac{3}{8}$ -10	1
	6	12	21	68.8	12	27.5	21.6	62.5	36.7	20	27	162	153239	QSLV4- $\frac{3}{8}$ -12	1
R $\frac{1}{2}$	6.2	12	21	71.8	15	28.6	21.6	63.6	36.7	20	27	171	153240	QSLV4- $\frac{1}{2}$ -12	1
<b>G thread with sealing ring</b>															
G $\frac{1}{8}$	2.3	4	10	40.6	5.1	13.4	13	-	22.2	10	14	30	186243	QSLV4-G $\frac{1}{8}$ -4	1
	2.9	6	12.5	40.6	5.1	13.4	13	-	24.2	12	14	34	186244	QSLV4-G $\frac{1}{8}$ -6	1
	4	8	14.5	45.6	5.1	15.4	15	-	27.7	14	17	53	186246	QSLV4-G $\frac{1}{8}$ -8	1
G $\frac{1}{4}$	2.9	6	12.5	42.1	5.6	14.4	13	-	24.2	12	17	42	186245	QSLV4-G $\frac{1}{4}$ -6	1
	4.1	8	14.5	46.1	5.6	15.4	15	-	27.7	14	17	54	186247	QSLV4-G $\frac{1}{4}$ -8	1
	5	10	17.5	54.1	5.6	18.9	18	-	31.7	17	22	92	186249	QSLV4-G $\frac{1}{4}$ -10	1
G $\frac{3}{8}$	4.1	8	14.5	47.6	6.6	15.9	15	-	27.7	14	19	63	186248	QSLV4-G $\frac{3}{8}$ -8	1
	5.1	10	17.5	55.6	6.6	19.4	18	-	31.7	17	22	94	186250	QSLV4-G $\frac{3}{8}$ -10	1
	6	12	21	65.8	6.6	24.2	21.6	-	36.7	20	27	158	186251	QSLV4-G $\frac{3}{8}$ -12	1
G $\frac{1}{2}$	6.2	12	21	66.8	7.6	24.2	21.6	-	36.7	20	27	162	186252	QSLV4-G $\frac{1}{2}$ -12	1

\* Packaging unit quantity



# Multiple distributors QSLV6, Quick Star

Technical data

## Multiple distributor QSLV6

No. of supply lines: 1

No. of outlets: 6



R thread

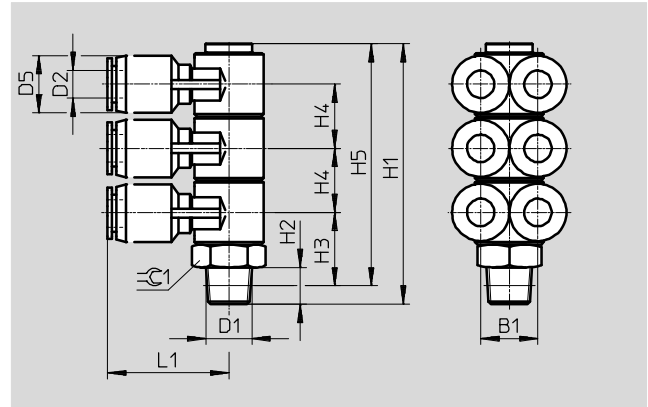

G thread

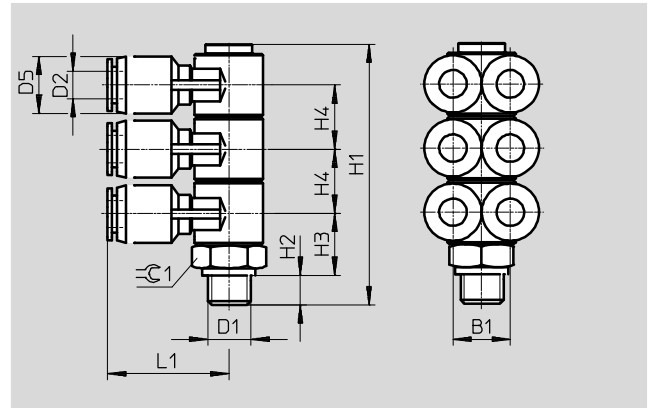

Dimensions and ordering data																
Connection	Nominal size	Tubing O.D.	D5	H1	H2	H3	H4	H5	L1	B1	±C1	Weight/ piece	Part No.	Type	PU*	
D1	[mm]	D2	∅									[g]				
<b>R thread</b>																
R <sup>1</sup> / <sub>8</sub>	2.3	4	10	54.7	8	15.5	13	50.7	22.2	10	14	40	153241	QSLV6-1/8-4	1	
	2.9	6	12.5	54.7	8	15.5	13	50.7	24.2	12	14	45	153242	QSLV6-1/8-6	1	
	4	8	14.5	61.7	8	17.5	15	57.7	27.7	14	17	71	153244	QSLV6-1/8-8	1	
R <sup>1</sup> / <sub>4</sub>	2.9	6	12.5	57.7	11	16.5	13	51.7	24.2	12	14	51	153243	QSLV6-1/4-6	1	
	4	8	14.5	64.7	11	18.5	15	58.7	27.7	14	17	73	153245	QSLV6-1/4-8	1	
	5.2	10	17.5	75.7	11	22	18	69.7	31.7	17	22	122	153247	QSLV6-1/4-10	1	
R <sup>3</sup> / <sub>8</sub>	4.1	8	14.5	65.7	12	19.2	15	59.4	27.7	14	17	81	153246	QSLV6-3/8-8	1	
	5.2	10	17.5	76.7	12	22.7	18	70.4	31.7	17	22	126	153248	QSLV6-3/8-10	1	
	6.3	12	21	90.5	12	27.5	21.6	84.2	36.7	20	27	205	153249	QSLV6-3/8-12	1	
R <sup>1</sup> / <sub>2</sub>	6.3	12	21	93.5	15	28.6	21.6	85.3	36.7	20	27	214	153250	QSLV6-1/2-12	1	
<b>G thread with sealing ring</b>																
G <sup>3</sup> / <sub>8</sub>	2.3	4	10	53.7	5.1	13.4	13	-	22.2	10	14	39	186253	QSLV6-G1/8-4	1	
	2.9	6	12.5	53.7	5.1	13.4	13	-	24.2	12	14	45	186254	QSLV6-G1/8-6	1	
	4	8	14.5	60.7	5.1	15.4	15	-	27.7	14	17	70	186256	QSLV6-G1/8-8	1	
G <sup>1</sup> / <sub>4</sub>	2.9	6	12.5	55.2	5.6	14.4	13	-	24.2	12	17	53	186255	QSLV6-G1/4-6	1	
	4	8	14.5	61.2	5.6	15.4	15	-	27.7	14	17	71	186257	QSLV6-G1/4-8	1	
	5.2	10	17.5	72.2	5.6	18.9	18	-	31.7	17	22	119	186259	QSLV6-G1/4-10	1	
G <sup>3</sup> / <sub>8</sub>	4.1	8	14.5	62.7	6.6	15.9	15	-	27.7	14	19	80	186258	QSLV6-G3/8-8	1	
	5.2	10	17.5	73.7	6.6	19.4	18	-	31.7	17	22	122	186260	QSLV6-G3/8-10	1	
	6.3	12	21	87.5	6.6	24.2	21.6	-	36.7	20	27	201	186261	QSLV6-G3/8-12	1	
G <sup>1</sup> / <sub>2</sub>	6.3	12	21	88.5	7.6	24.2	21.6	-	36.7	20	27	205	186262	QSLV6-G1/2-12	1	

\* Packaging unit quantity

# Multiple distributors QSQ, Quick Star

Technical data

## Multiple distributor QSQ

No. of supply lines: 1

No. of outlets: 4



R thread

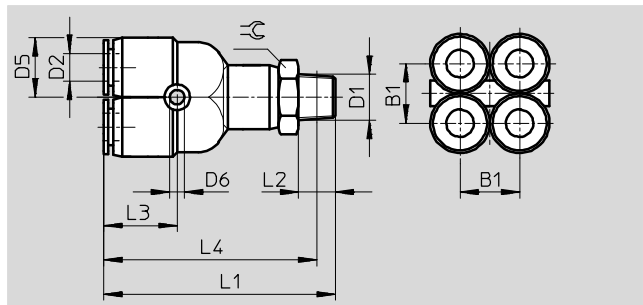

G thread

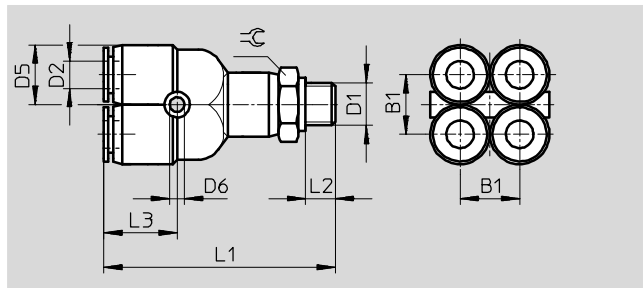

Reducing

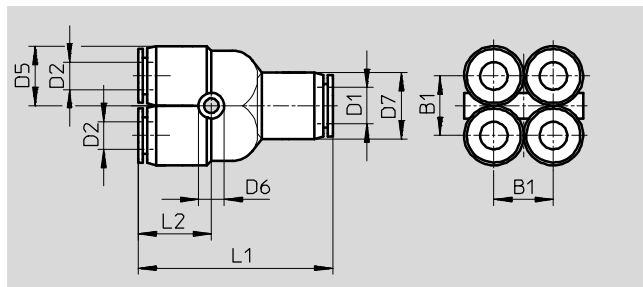

Dimensions and ordering data															
Connection	Nominal size	Tubing O.D.	B1	D5	D6	D7	L1	L2	L3	L4	∅	Weight/ piece	Part No.	Type	PU*
D1	[mm]	D2		∅	∅	∅						[g]			
<b>R thread</b>															
R $\frac{1}{8}$	2	4	10	10.5	3.2	-	46	8	14	42	12	21.5	153206	QSQ- $\frac{1}{8}$ -4	1
	2.1	6	13	13	3.2	-	50.5	8	16	56.5	12	29	153208	QSQ- $\frac{1}{8}$ -6	1
R $\frac{1}{4}$	2	4	10	10.5	3.2	-	49	11	14	43	14	29.5	153207	QSQ- $\frac{1}{4}$ -4	1
	2.1	6	13	13	3.2	-	53.5	11	16	48	16	29	153288	QSQ- $\frac{1}{4}$ -6	1
<b>G thread with sealing ring</b>															
G $\frac{1}{8}$	1.4	4	10	10.5	3.2	-	44.7	5.1	14.2	-	13	22	186220	QSQ-G $\frac{1}{8}$ -4	1
	3.4	6	13	13	3.5	-	49.3	5.1	15.8	-	14	28	186222	QSQ-G $\frac{1}{8}$ -6	1
G $\frac{1}{4}$	1.3	4	10	10.5	3.2	-	46.2	5.6	14.2	-	17	31	186221	QSQ-G $\frac{1}{4}$ -4	1
	3	6	13	13	3.5	-	50.8	5.6	15.8	-	17	37	186263	QSQ-G $\frac{1}{4}$ -6	1
<b>Reducing</b>															
6	1.4	4	10	10.5	3.2	13	37.5	14	-	-	-	14	153209	QSQ-6-4	1
8	3.2	6	13	13	3.2	14.5	42.5	16	-	-	-	20.5	153210	QSQ-8-6	1

\* Packaging unit quantity

# Multiple distributors QST3, Quick Star

Technical data

## Multiple distributor QST3

No. of supply lines: 1

No. of outlets: 4



R thread

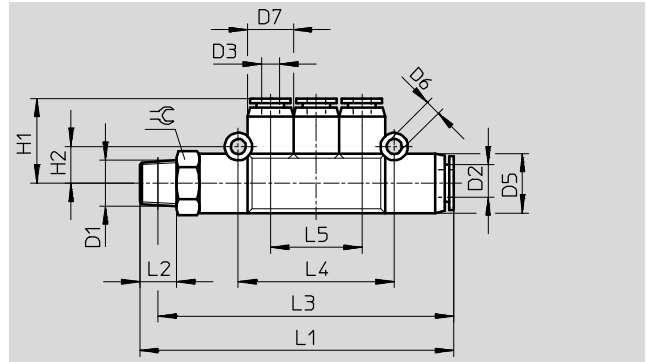

G thread

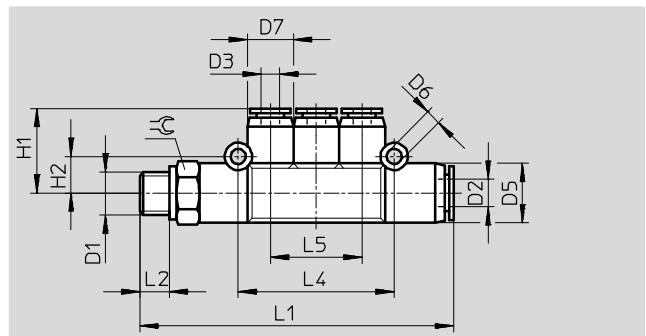

Reducing

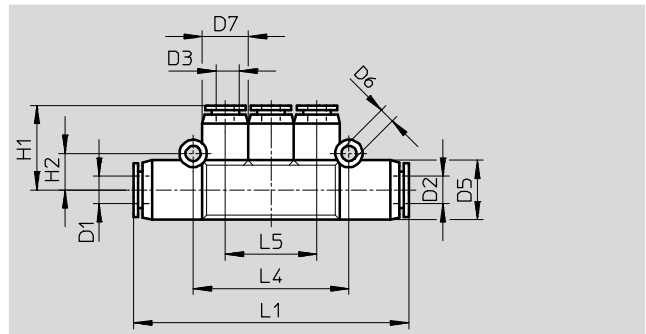

Dimensions and ordering data																		
Con- nec- tion	Nom- inal size [mm]	Tubing O.D.		D5 ∅	D6 ∅	D7 ∅	H1	H2	L1	L2	L3	L4	L5	≈C	Weight [g]	Part No.	Type	PU*
		D2	D3															
<b>R thread</b>																		
R $\frac{1}{8}$	2.5	6	4	13	3.3	10	18.5	8	68.5	8	64.5	34	20	12	23	153200	QST3- $\frac{1}{8}$ -6-4	1
R $\frac{1}{4}$	3.5	8	6	15	3.3	13	20	9	81	11	75	40	24	14	36.5	153201	QST3- $\frac{1}{4}$ -8-6	1
R $\frac{3}{8}$	4.9	10	8	18	3.3	15	24	10.5	93.5	12	87	46	28	17	59.5	153202	QST3- $\frac{3}{8}$ -10-8	1
<b>G thread with sealing ring</b>																		
G $\frac{1}{8}$	2.5	6	4	13	3.3	10	18.4	8	67.4	5.1	-	34	20	13	24	186217	QST3-G $\frac{1}{8}$ -6-4	1
G $\frac{1}{4}$	3.5	8	6	15	3.3	13	21.3	9	78.2	5.6	-	40.2	24	17	39	186218	QST3-G $\frac{1}{4}$ -8-6	1
G $\frac{3}{8}$	4.9	10	8	17.5	3.3	15	23.7	10.5	90	6.6	-	46.2	28	19	59	186219	QST3-G $\frac{3}{8}$ -10-8	1
<b>Reducing</b>																		
6	2.5	6	4	13	3.3	10	18.5	8	60	-	-	34	20	-	16	153203	QST3-6-4	1
8	3.6	8	6	15	3.3	13	21	9	69.5	-	-	40	24	-	23	153204	QST3-8-6	1
10	4.9	10	8	18	3.3	15	23.5	10.5	80	-	-	46	28	-	33	153205	QST3-10-8	1

\* Packaging unit quantity