

Mini slides DGSL



# Mini slides DGSL

Key features

FESTO

## General

- Double-acting drives
- Wide range of mounting options
- System product for handling and assembly technology
- Highly flexible thanks to a wide range of assembly and connection options on:
  - Drive body, slide, yoke plate

## The technology in detail

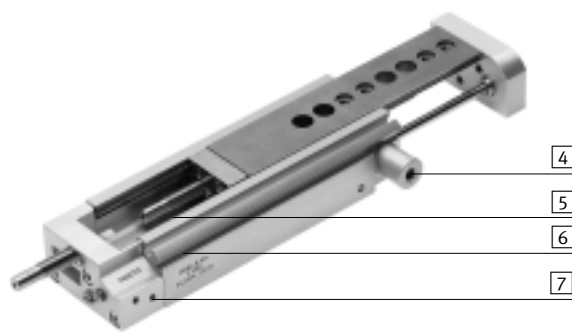

### 1 Cushioning



- Choice of five cushioning types:
  - Elastic cushioning without metal end position (P)
  - Elastic cushioning without metal end position, short design (E)
  - Elastic cushioning with metal end position (P1)
  - Shock absorber (Y3)
  - Shock absorber with reducing sleeve (Y11)
- Alternative:
  - Without cushioning (N)

### 2 Cover

→ 45



- The cover stops foreign parts or dirt getting into the guide
- The cover comes in different lengths and can be trimmed as required by the customer

### 3 Coarse stroke adjustment

→ 10



- The end stop for the advanced end position can be adjusted mechanically, for example to shorten the stroke

### 4 Clamping unit

→ 40



- Mechanical clamping, for fixing the slide in any position; frictional locking (C)

### 4 End-position locking

→ 40



- Mechanical locking when the end position is reached, for fixing the slide in the unpressurised, retracted state; positive locking (E3)

### 5 Innovative guide unit

- Wide roller track, which provides extremely high rigidity
- High load capacity
- High precision
- Housing and steel slide form a guide: there are no accumulative tolerances

### 6 Position sensing

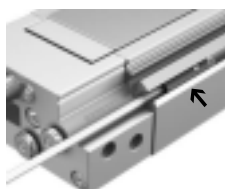

- Proximity sensors can be integrated, so there are no projecting parts
- Two slots for mounting
- Clearly visible from the side and from above

### 7 Supply ports

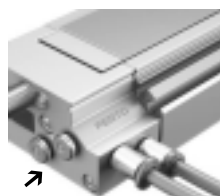

- Choice of two sides:
  - On the front
  - On the side

# Mini slides DGSL

System example

## The technology in detail

Intermediate position module

→ 46



The intermediate position module enables an additional adjustable position within the stroke range.

- 1 Shock absorber retainer
- 2 Intermediate position module

- The symmetric design enables the intermediate position to be approached during the advance or return stroke, depending on the installation position
- Intermediate position can be travelled through from the end position
- Travel can be continued directly from the intermediate position
- Easy to assemble
- Sensing of the stop lever position possible

## System product for handling and assembly technology

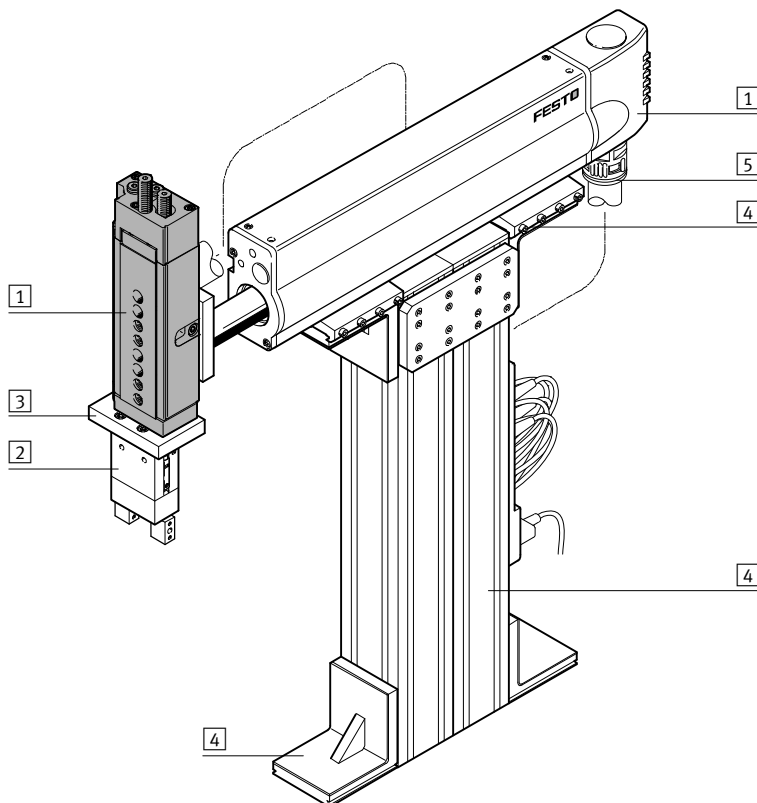

System components and accessories		
	Description	→ Page/Internet
1	Drives	drive
2	Grippers	gripper
3	Adapters	For drive/drive connections
		For drive/gripper connections
4	Basic components	basic component
5	Installation components	installation component
-	Axes	axis
-	Motors	motor

# Mini slides DGSL

Peripherals overview

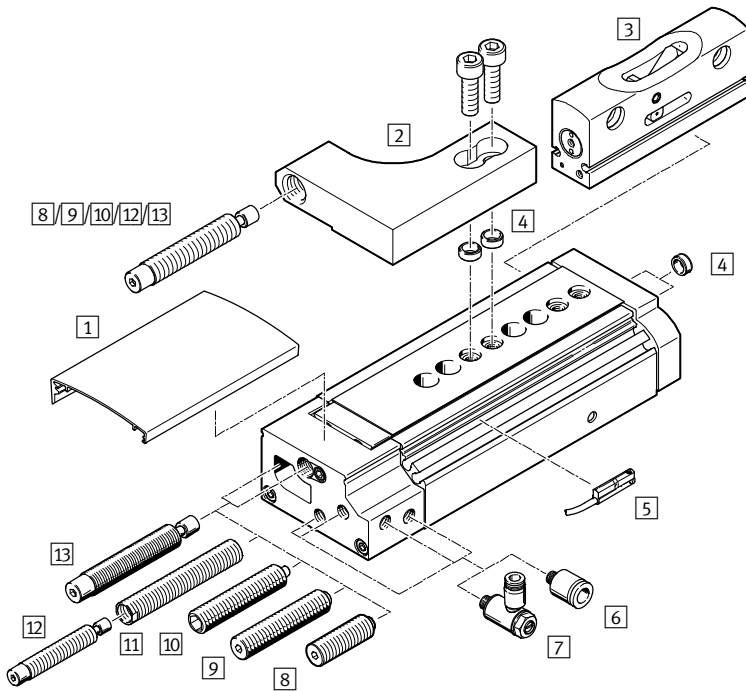

 Note  
Operation without cushioning components is not permitted.

Accessories			
	Description	→ Page/Internet	
1	Cover DADS	<ul style="list-style-type: none"> <li>For protection, to stop foreign parts or dirt getting into the guide</li> <li>The cover can be trimmed as required by the customer</li> </ul>	45
2	Shock absorber retainer DADP	<ul style="list-style-type: none"> <li>Attachment for the shock absorber</li> <li>For positioning and cushioning the intermediate position</li> </ul>	48
3	Intermediate position module DADM	With stop lever for the intermediate position	46
4	Centring sleeve ZBH	For centring loads and attachments (centring sleeves are included in the scope of delivery of the mini slide)	50
5	Proximity sensor SME/SMT-10	For position sensing. Can be integrated in the sensor slot, so there are no projecting parts	51
6	Push-in fitting QSM	For connecting compressed air tubing with standard O.D.	50
7	One-way flow control valve GRLA	For regulating speed	50
8	Cushioning E	<ul style="list-style-type: none"> <li>Flexible stop for medium loads at medium speed</li> <li>(short design)</li> </ul>	49
9	Cushioning P	<ul style="list-style-type: none"> <li>Flexible stop for medium loads at medium speed</li> <li>(standard design)</li> </ul>	49
10	Cushioning with stop P1	Precision metal stop for small loads at low speed	49
11	Reducing sleeve DAYH	For installing a smaller shock absorber. For applications where the cushioning energy lies between the cushioning Y3 and P1	49
12	Shock absorber DYSW	→ 12 (shock absorber selection)	49
13	Cushioning with shock absorber Y3	For large loads and high speed. Ensures precise, metal-to-metal contact after the cushioning	49

# Mini slides DGSL

Type codes

		DGSL	-	10	-	100	-		-	E3	-	Y3	-	A
<b>Type</b>														
Double-acting														
DGSL	Mini slide													
<b>Size</b>														
<b>Stroke [mm]</b>														
<b>Clamping unit</b>														
C	Attached													
<b>End-position locking</b>														
E3	With piston rod in retracted position													
<b>Cushioning</b>														
P	Elastic cushioning without metal end position, at both ends													
P1	Elastic cushioning with metal end position, at both ends													
Y3	Progressive shock absorber, at both ends													
E	Elastic cushioning without metal end position, at both ends, short design													
Y11	Progressive shock absorber with reducing sleeve, at both ends													
N	No cushioning													
<b>Position sensing</b>														
A	Via proximity sensor													

# Mini slides DGSL

Technical data

FESTO

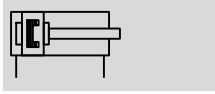

Function



Wearing parts kits

→ 45



-  - Size  
4 ... 25
-  - Stroke length  
10 ... 200 mm

General technical data			4	6	8	10	12	16	20	25
Size			4	6	8	10	12	16	20	25
Pneumatic connection			M3			M5		G1/8		
Design			Scotch yoke system							
Guide			Ball bearing cage guide							
Type of mounting			With through-hole							
			Via female thread							
Cushioning	P		Elastic cushioning without metal end position, at both ends							
	E		Elastic cushioning without metal end position, at both ends, short design							
	P1		Elastic cushioning with metal end position, at both ends, adjustable							
	Y3		-		Progressive shock absorber, at both ends					
	Y11		-		Progressive shock absorber with reducing sleeve, at both ends					
	N		-		No cushioning					
Position sensing			Via proximity sensor							
Mounting position			Any							
Max. advancing speed	[m/s]		0.5			0.8				
Max. retracting speed	[m/s]		0.5			0.8				
Repetition accuracy	P1/Y3	[mm]	±0.01							
	P	[mm]	0.3							

Operating and environmental conditions			4	6	8	10	12	16	20	25
Size			4	6	8	10	12	16	20	25
Operating medium			Compressed air to ISO 8573-1:2010 [7:4:4]							
Note on operating/pilot medium			Lubricated operation possible (in which case lubricated operation will always be required)							
Min. operating pressure	[bar]		2.5		1.5		1			
Max. operating pressure <sup>1)</sup>	[bar]		8							
Ambient temperature <sup>2)</sup>	[°C]		0 ... +60							

1) Note max. operating pressure in combination with the intermediate position module DADM-EP → Internet: dadm

2) Note operating range of proximity sensors

Piston Ø, forces and impact energy			4	6	8	10	12	16	20	25
Size			4	6	8	10	12	16	20	25
Piston Ø	[mm]		6	8	10	12	16	20	25	32
Theoretical force at 6 bar, advancing	[N]		17	30	47	68	121	188	295	483
Theoretical force at 6 bar, retracting	[N]		13	23	40	51	104	158	247	415
Impact energy in the end positions	P, E	[Nm]	0.015	0.05	0.08	0.12	0.25	0.35	0.45	0.55
	P1	[Nm]	0.005	0.02	0.03	0.04	0.06	0.12	0.2	0.25
	Y3	[Nm]	-	-	0.8	1.3	2.5	4	8	12
	1)	[Nm]	-	-	-	0.8	1.3	2.5	4	8

1) With reducing sleeve and next smallest shock absorber

# Mini slides DGSL

Technical data

FESTO

Weight [g]									
Size	Stroke	4	6	8	10	12	16	20	25
Product weight without cushioning component									
10	82	158	235	396	604	896	1,535	2,520	
20	93	179	263	434	660	954	1,649	2,670	
30	104	197	289	470	711	1,008	1,746	2,824	
40	–	215	313	507	762	1,072	1,857	2,983	
50	–	232	370	548	813	1,143	1,991	3,137	
80	–	–	454	727	1,112	1,365	2,295	4,019	
100	–	–	–	813	1,229	1,712	2,921	4,519	
150	–	–	–	–	1,499	2,034	3,620	5,344	
200	–	–	–	–	–	–	4,248	6,139	
Moving load without cushioning component									
10	31	68	101	163	256	403	660	998	
20	34	76	111	180	279	432	710	1,052	
30	38	83	121	194	299	459	750	1,115	
40	–	90	130	208	320	486	801	1,181	
50	–	99	152	226	340	519	858	1,244	
80	–	–	185	299	456	618	998	1,567	
100	–	–	–	334	507	776	1,254	1,761	
150	–	–	–	–	614	910	1,566	2,102	
200	–	–	–	–	–	–	1,807	2,432	
Cushioning component									
P	2	3.6	6	14	23	45.6	82.4	106	
E	1	2	3	9	12	15	31	40	
P1	1.6	3	5	12	19.7	39.6	77.3	104	
Y3	–	–	6	11	21	42	67	91	
1)	–	–	–	18	33	52	91	131	

1) With reducing sleeve and next smallest shock absorber

## Materials

Sectional view

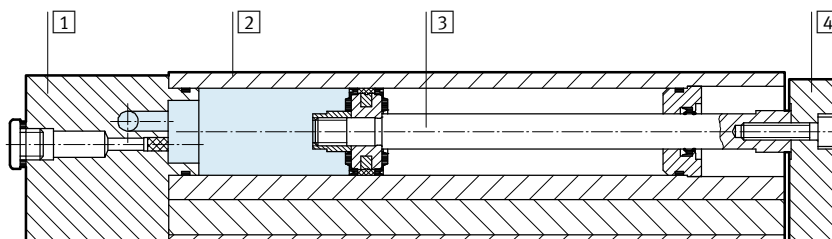

Mini slide		
1	End cap	Anodised aluminum
2	Housing	Anodised aluminum
3	Piston rod	High-alloy steel
4	Yoke plate	Anodised aluminum
–	Guide	Tempered steel
–	Seals	Thermoplastic rubber, hydrogenated nitrile rubber, nitrile rubber
Note on materials		Free of copper and PTFE

# Mini slides DGSL

Technical data

## Possible combinations without adapter plate

Pick & place

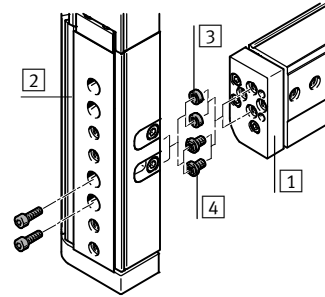
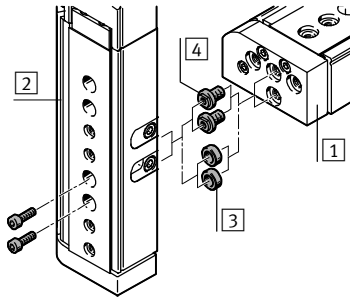

- 3 Centring sleeve ZBH
- 4 Connector sleeve ZBV

## Piggy-back assembly

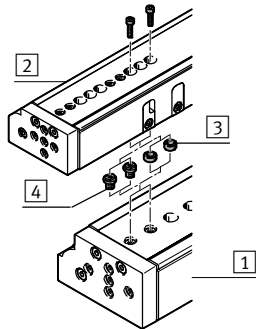

- 3 Centring sleeve ZBH
- 4 Connector sleeve ZBV

## Mounting example with connector sleeve ZBV

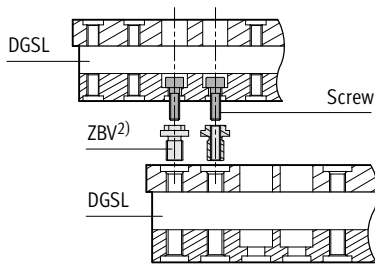

		1 Basic drive								
		Size	4	6	8	10	12	16	20	25
2 Assembly drive	4		2x M3x7 2x ZBH-5 <sup>1)</sup>	2x M3x10 2x ZBH-5 <sup>1)</sup>	ZBV-M4-7 <sup>2)</sup>	ZBV-M4-7 <sup>2)</sup>	-	-	-	-
	6		-	2x M3x10 2x ZBH-5 <sup>1)</sup>	ZBV-M4-7 <sup>2)</sup>	ZBV-M4-7 <sup>2)</sup>	-	-	-	-
	8		-	-	2x M4x12 2x ZBH-7 <sup>1)</sup>	2x M4x12 2x ZBH-7 <sup>1)</sup>	ZBV-M5-7 <sup>2)</sup>	ZBV-M5-7 <sup>2)</sup>	-	-
	10		-	-	-	2x M4x14 2x ZBH-7 <sup>1)</sup>	ZBV-M5-7 <sup>2)</sup>	ZBV-M5-7 <sup>2)</sup>	-	-
	12		-	-	-	-	2x M5x14 2x ZBH-7 <sup>1)</sup>	2x M5x16 2x ZBH-7 <sup>1)</sup>	ZBV-M6-9 <sup>2)</sup>	ZBV-M6-9 <sup>2)</sup>
	16		-	-	-	-	-	2x M5x18 2x ZBH-7 <sup>1)</sup>	ZBV-M6-9 <sup>2)</sup>	ZBV-M6-9 <sup>2)</sup>
	20		-	-	-	-	-	-	2x M6x20 2x ZBH-9 <sup>1)</sup>	2x M6x20 2x ZBH-9 <sup>1)</sup>
	25		-	-	-	-	-	-	-	2x M6x30 2x ZBH-9 <sup>1)</sup>

1) Centring sleeves ZBH are included in the scope of delivery of the mini slide DGSL

2) Connector sleeves ZBV → 50



# Mini slides DGSL

Technical data

## Parallelism [mm]

The term parallelism refers to the accuracy of alignment between the mounting surface and the slide surface.

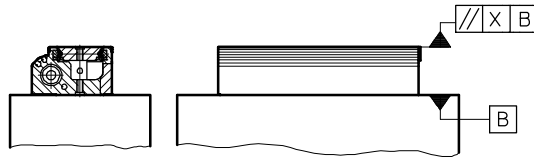

Size	Stroke [mm]	4	6	8	10	12	16	20	25
Parallelism X	10	0.02	0.02	0.02	0.02	0.02	0.02	0.02	0.02
	20	0.02	0.02	0.02	0.02	0.025	0.025	0.025	0.025
	30	0.025	0.025	0.025	0.025	0.025	0.025	0.025	0.03
	40	-	0.025	0.025	0.025	0.025	0.03	0.03	0.035
	50	-	0.03	0.03	0.03	0.03	0.035	0.035	0.04
	80	-	-	0.035	0.035	0.035	0.04	0.04	0.045
	100	-	-	-	0.045	0.045	0.05	0.05	0.055
	150	-	-	-	-	0.075	0.075	0.075	0.08
200	-	-	-	-	-	-	0.08	0.08	

## Linearity [mm]

The term linearity refers to the accuracy of alignment between the mounting surface and the slide surface as a function of the stroke.

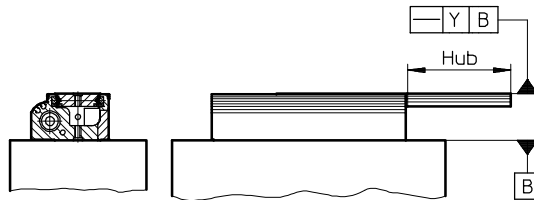

Linear travel accuracy y as a function of stroke length l

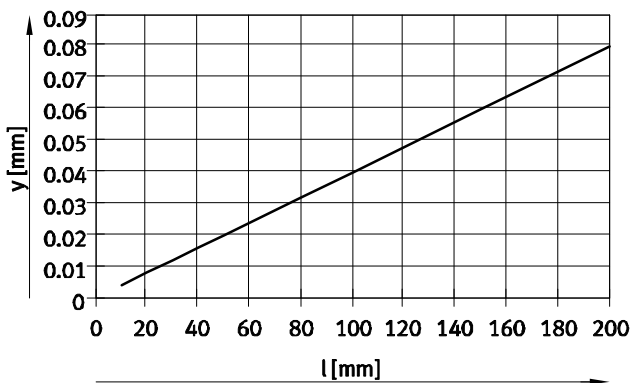

# Mini slides DGSL

Technical data

## Adjustable end-position range

Coarse adjustment of the advanced end position

The mini slide DGSL allows the advanced fixed stop to be adjusted by removing the cover. This permits stroke reduction down to

the next but one smaller standard stroke through a combination of coarse and precision adjustments.

### Advantages:

- Can be flexibly adapted to the application
- Integrated, which means reduced conversion effort and costs
- Large setting range



Note

Removal of the fixed stops can severely damage the mini slide DGSL.

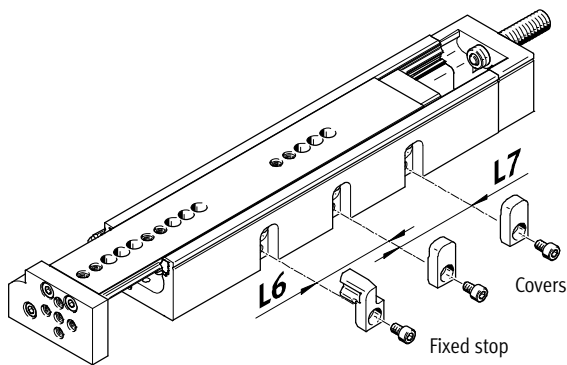

Size Stroke [mm]	4		6		8		10		12		16		20		25	
	L6	L7	L6	L7	L6	L7	L6	L7	L6	L7	L6	L7	L6	L7	L6	L7
10	-	-	-	-	-	-	-	-	-	-	-	-	-	-	-	-
20	10	-	14	-	10	-	-	-	-	-	-	-	-	-	-	-
30	10	-	14	-	16	-	-	-	-	-	-	-	-	-	-	-
40	-	-	14	-	16	-	-	-	-	-	-	-	-	-	-	-
50	-	-	14	14	16	-	-	-	-	-	-	-	-	-	-	-
80	-	-	-	-	16	16	24	-	29	-	35	-	-	-	55	-
100	-	-	-	-	-	-	24	24	29	-	35	-	44	-	55	-
150	-	-	-	-	-	-	-	-	29	29	35	-	44	-	55	-
200	-	-	-	-	-	-	-	-	-	-	-	-	44	44	55	-

### Example:

DGSL-12-150-...

Max. stroke = 150 mm

By adjusting the fixed stop by the dimension L6:

$$\text{Stroke} = 150 - 29 = 121 \text{ mm}$$

By adjusting the fixed stop by the dimension L6 and L7:

$$\text{Stroke} = 150 - 29 - 29 = 92 \text{ mm}$$

The stroke can also be reduced through a precision adjustment:

$$\text{Stroke} = 150 - 29 - 29 - 29 = 63 \text{ mm}$$

Precision adjustment of the advanced and retracted end position

→ 11

# Mini slides DGSL

Technical data

## Adjustable end-position range

Precision adjustment of the advanced and retracted end position

Precision adjustment of the required stroke reduction is possible using the cushioning components (on the slide and in the end cap).

### Advantages:

- Precision adjustment is accurately fixed by the clamping component
- No readjustment required, position is fully retained under lock and load
- Quick and easy adjustment, only one tool required

### Step 1:

Loosen the clamping component.

### Step 2:

Position the slide by hand in the required end position.

### Step 3:

Turn the stop element using an Allen key until the end position is reached.

### Step 4:

Tighten the clamping component.

### Step 1

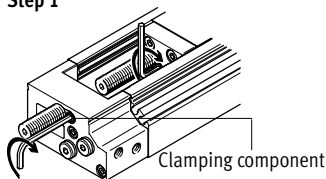

### Step 2 ... 4

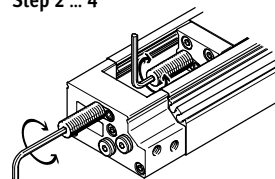

Adjustable end-position range [mm] per end position/stroke reduction									
Size		4	6	8	10	12	16	20	25
<b>Advanced end position</b>									
With cushioning	P	-14.5	-16.5	-19.5	-27.5	-29	-37.5	-50.5	-55
	E	-4.5	-5	-4.5	-13	-9	-3.5	-6.5	-11.5
	P1	-14.5	-16.5	-19.5	-27.5	-29	-37.5	-50.5	-55
	Y3	-	-	-15	-24	-29	-36.5	-44	-56
	1)	-	-	-	-24	-29	-36.5	-44	-56
<b>Retracted end position</b>									
With cushioning	P	-13.5	-15	-18.5	-20	-25.5	-39.5	-49.5	-49
	E	-3.5	-3.5	-3.5	-5.5	-5.5	-5.5	-5.5	-5.5
	P1	-13.5	-15	-18.5	-20	-25.5	-39.5	-49.5	-49
	Y3	-	-	-14	-15	-25.5	-38.5	-42	-51.5
	1)	-	-	-	-15	-25.5	-38.5	-42	-51.5

1) With reducing sleeve and next smallest shock absorber

Note

The distance L of the cushioning component (→ operating instructions) must not be fallen below (factory setting).

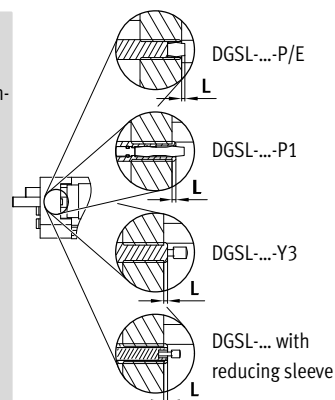

Note

The setting range of the advanced and retracted end position is restricted when using the cushioning type "E".

# Mini slides DGSL

Technical data

## Shock absorber selection

Payload load  $m$  as a function of impact velocity  $v$

With the mini slide DGSL the shock absorber can be replaced and the cushioning behaviour can thus be influenced (depending on the payload).

This is done by removing the existing shock absorbers on the DGSL and replacing them with a smaller shock absorber as appropriate to the application (→ description below).

### Graphs

for selecting a suitable shock absorber as a function of the mounting position of the mini slide → from 13.

### Ordering data

Shock absorbers DYSW, DYEF and reducing sleeve DAYH → 49.

### With smaller loads:

The next smallest shock absorber DYSW can be installed with the help of the reducing sleeve DAYH.

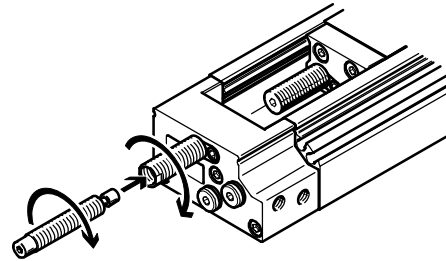
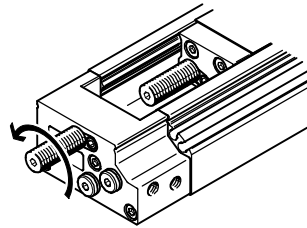

### With very small loads:

The shock absorber DYEF can be installed.

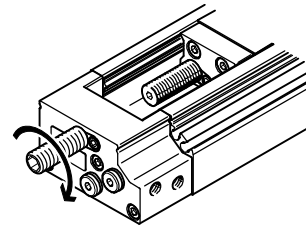
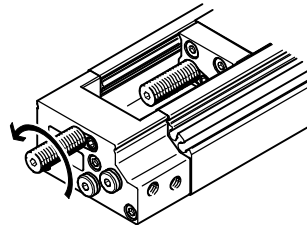

### Selection example:

Current drive:

Mini slide: DGSL-10-...-Y3-A

Given:

Payload: 500 g

Impact velocity: 0.4 m/s

Mounting position: Horizontal

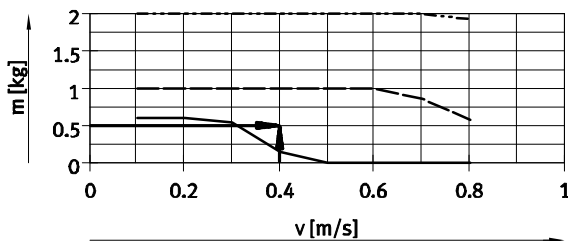

- DYSW-5-8 (cushioning Y3)
- DYSW-4-6 with DAYH-4 (cushioning Y11)
- DYEF-M8-Y1F

Result:

The first cushioning curve, which is located above the point of intersection, is the most suitable in this case. Due to the low payload of less than one kilogram, the cushioning characteristics are greatly improved by

replacing the shock absorber DYSW-5-8 integrated in the mini slide with the reducing sleeve DAYH-4 and the next smallest shock absorber DYSW-4-6.

Fundamentally, the following applies: shock absorbers must be loaded. Since the shock absorber DYSW-4-6 is more fully utilised in this case, both

the service life of the shock absorber and the cushioning characteristics are improved.

# Mini slides DGSL

Technical data

## Shock absorber selection

Payload  $m$  as a function of impact velocity  $v$  – horizontal mounting position

### DGSL-4

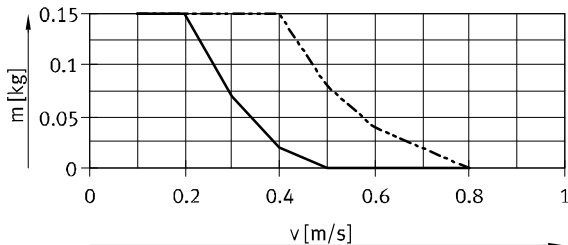

- DYEF-M4-Y1F (cushioning P1)
- - - DYEF-M4-Y1 (cushioning P)

### DGSL-6

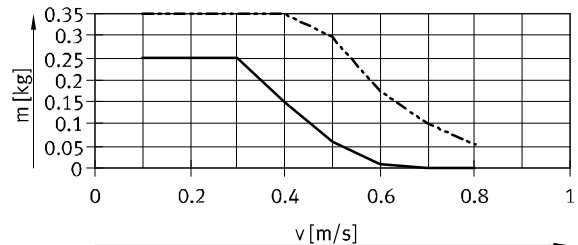

- DYEF-M5-Y1F (cushioning P1)
- - - DYEF-M5-Y1 (cushioning P)

### DGSL-8

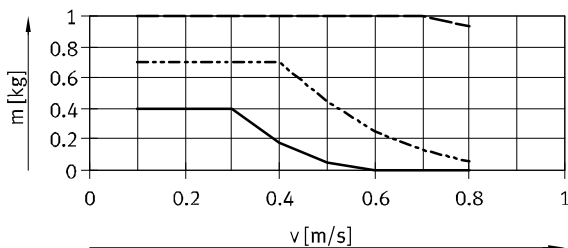

- DYEF-M6-Y1F (cushioning P1)
- - - DYEF-M6-Y1 (cushioning P)
- · - DYSW-4-6 (cushioning Y3)

### DGSL-10

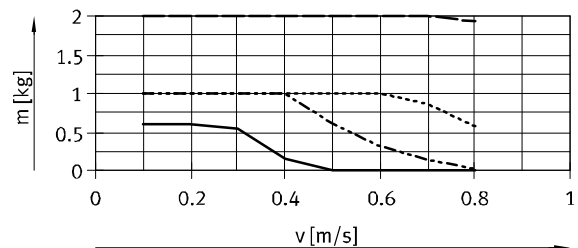

- DYEF-M8-Y1F (cushioning P1)
- - - DYEF-M8-Y1 (cushioning P)
- · - DYSW-5-8 (cushioning Y3)
- · · DYSW-4-6 with DAYH-4 (cushioning Y11)

### DGSL-12

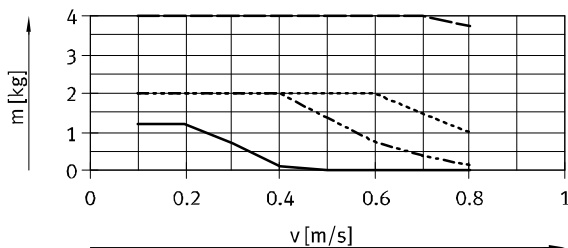

- DYEF-M10-Y1F (cushioning P1)
- - - DYEF-M10-Y1 (cushioning P)
- · - DYSW-7-10 (cushioning Y3)
- · · DYSW-5-8 with DAYH-5 (cushioning Y11)

### DGSL-16

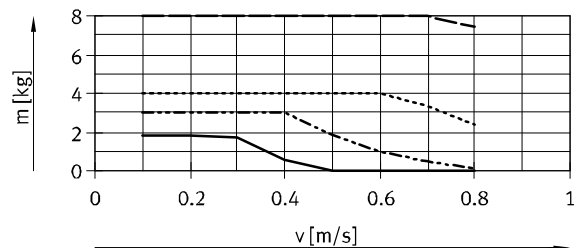

- DYEF-M12-Y1F (cushioning P1)
- - - DYEF-M12-Y1 (cushioning P)
- · - DYSW-8-14 (cushioning Y3)
- · · DYSW-7-10 with DAYH-7 (cushioning Y11)

### DGSL-20

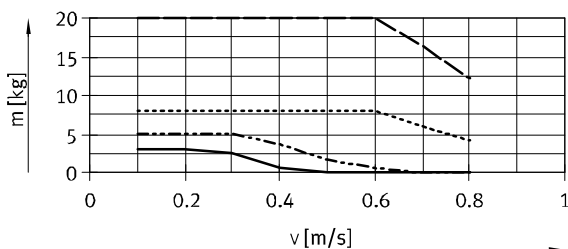

- DYEF-M14-Y1F (cushioning P1)
- - - DYEF-M14-Y1 (cushioning P)
- · - DYSW-10-17 (cushioning Y3)
- · · DYSW-8-14 with DAYH-8 (cushioning Y11)

### DGSL-25

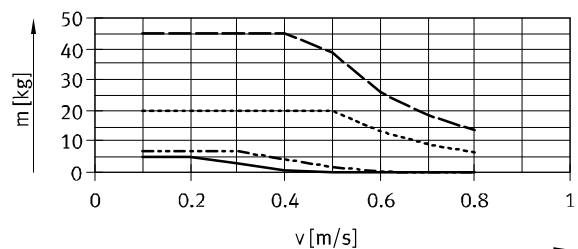

- DYEF-M16-Y1F (cushioning P1)
- - - DYEF-M16-Y1 (cushioning P)
- · - DYSW-12-20 (cushioning Y3)
- · · DYSW-10-17 with DAYH-10 (cushioning Y11)

# Mini slides DGSL

Technical data

FESTO

## Shock absorber selection

Payload  $m$  as a function of impact velocity  $v$  – vertical mounting position, payload moving upwards

### DGSL-4

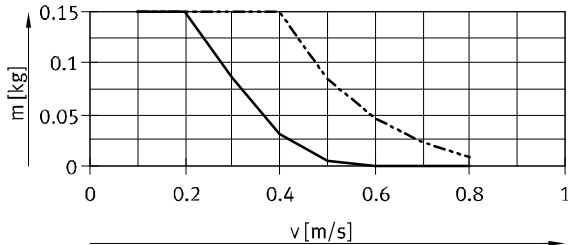

— DYEF-M4-Y1F (cushioning P1)  
 - - - DYEF-M4-Y1 (cushioning P)

### DGSL-6

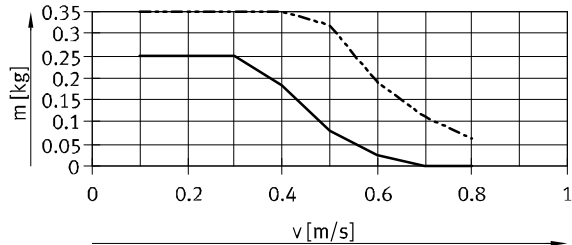

— DYEF-M5-Y1F (cushioning P1)  
 - - - DYEF-M5-Y1 (cushioning P)

### DGSL-8

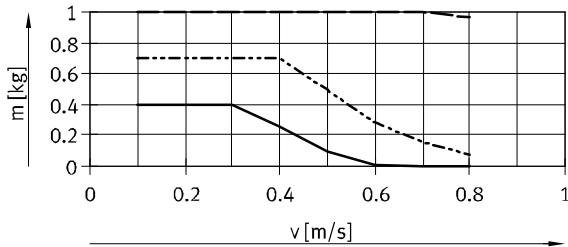

— DYEF-M6-Y1F (cushioning P1)  
 - - - DYEF-M6-Y1 (cushioning P)  
 - · - DYSW-4-6 (cushioning Y3)

### DGSL-10

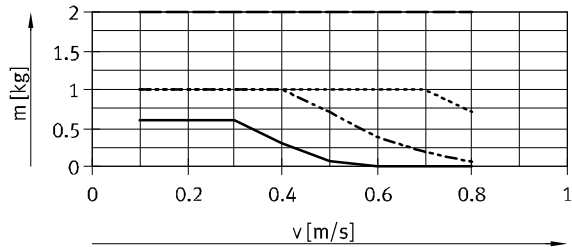

— DYEF-M8-Y1F (cushioning P1)  
 - - - DYEF-M8-Y1 (cushioning P)  
 - · - DYSW-5-8 (cushioning Y3)  
 ····· DYSW-4-6 with DAYH-4 (cushioning Y11)

### DGSL-12

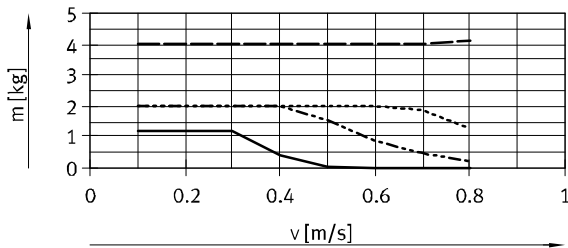

— DYEF-M10-Y1F (cushioning P1)  
 - - - DYEF-M10-Y1 (cushioning P)  
 - · - DYSW-7-10 (cushioning Y3)  
 ····· DYSW-5-8 with DAYH-5 (cushioning Y11)

### DGSL-16

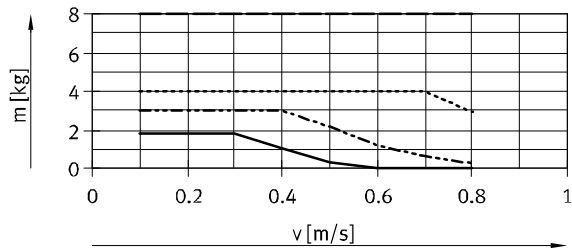

— DYEF-M12-Y1F (cushioning P1)  
 - - - DYEF-M12-Y1 (cushioning P)  
 - · - DYSW-8-14 (cushioning Y3)  
 ····· DYSW-7-10 with DAYH-7 (cushioning Y11)

### DGSL-20

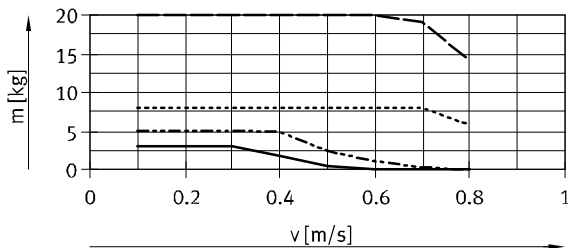

— DYEF-M14-Y1F (cushioning P1)  
 - - - DYEF-M14-Y1 (cushioning P)  
 - · - DYSW-10-17 (cushioning Y3)  
 ····· DYSW-8-14 with DAYH-8 (cushioning Y11)

### DGSL-25

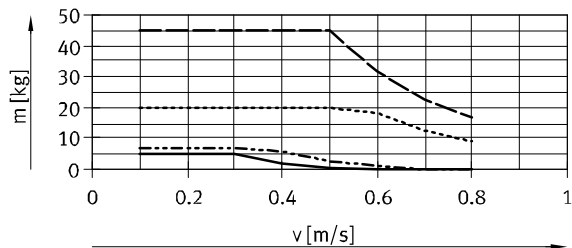

— DYEF-M16-Y1F (cushioning P1)  
 - - - DYEF-M16-Y1 (cushioning P)  
 - · - DYSW-12-20 (cushioning Y3)  
 ····· DYSW-10-17 with DAYH-10 (cushioning Y11)

# Mini slides DGSL

Technical data

## Shock absorber selection

Payload  $m$  as a function of impact velocity  $v$  – vertical mounting position, payload moving downwards

DGSL-4

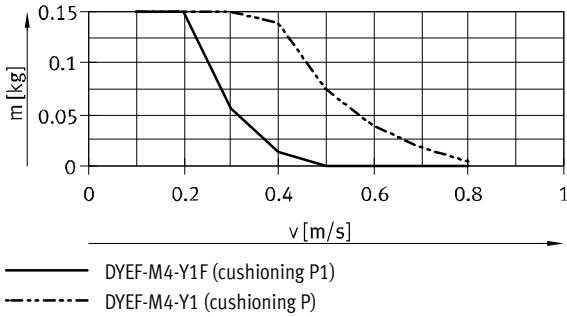

DGSL-6

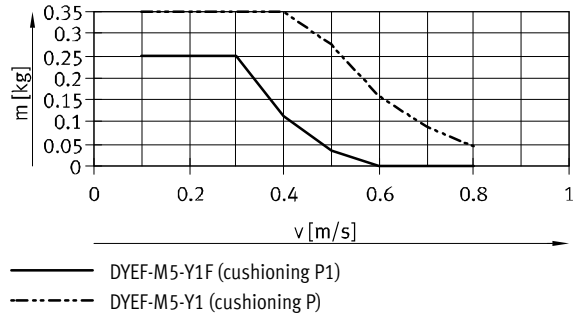

DGSL-8

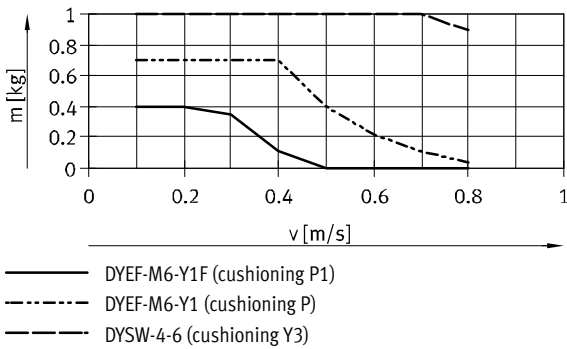

DGSL-10

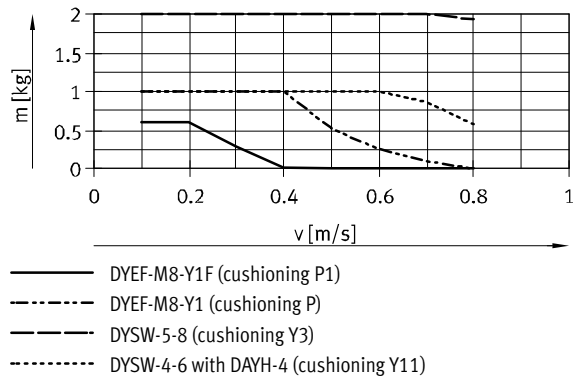

DGSL-12

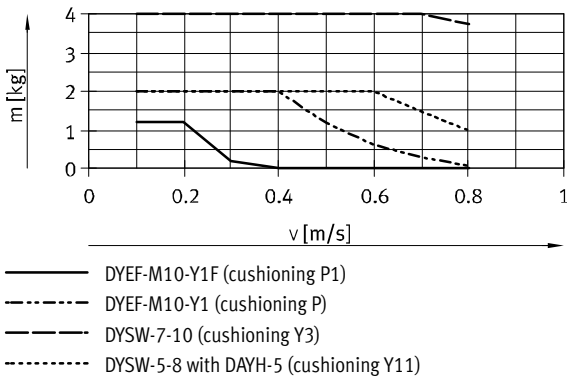

DGSL-16

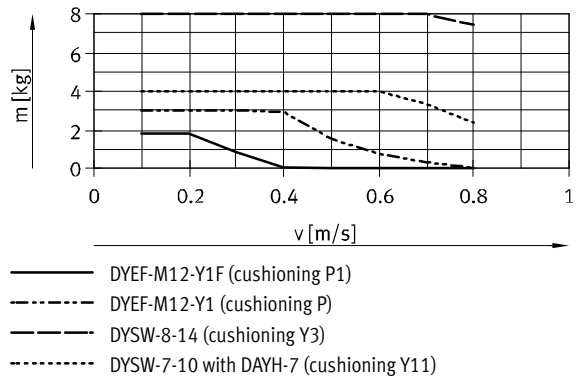

DGSL-20

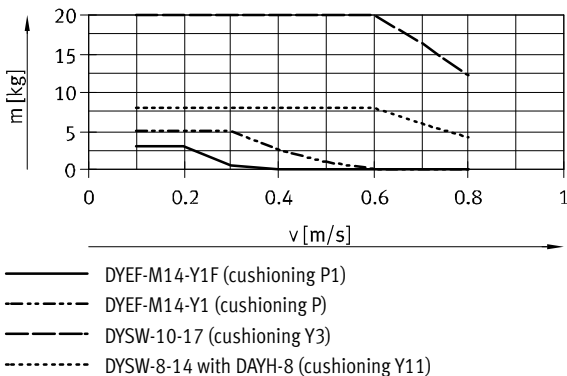

DGSL-25

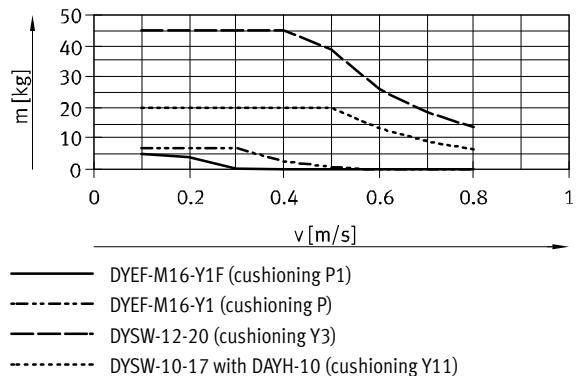

# Mini slides DGSL

Technical data



## Shock absorber selection

Travel time  $t$  as a function of payload  $m$  and cushioning P/E – horizontal mounting position

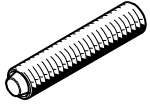

The values in the graphs are determined by calculation. The travel time as a function of payload must not be reduced below the

values shown, because the kinetic impact or residual energy in the end positions can result in damage to the drive.

Vertical mounting position  
→ 19

### Advancing

Stroke 10 mm, size 4 ... 10

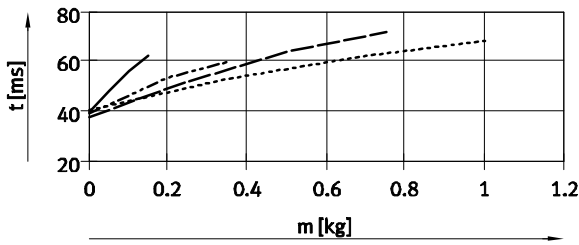

### Retracting

Stroke 10 mm, size 4 ... 10

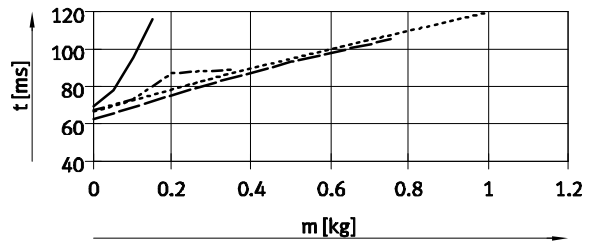

Stroke 10 mm, size 12 ... 16

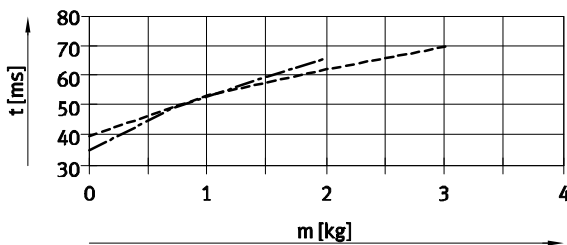

Stroke 10 mm, size 12 ... 16

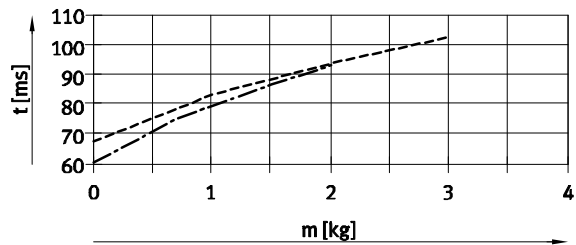

Stroke 10 mm, size 20 ... 25

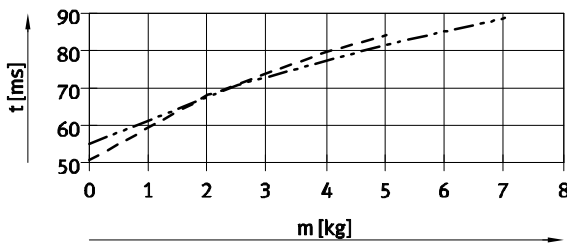

Stroke 10 mm, size 20 ... 25

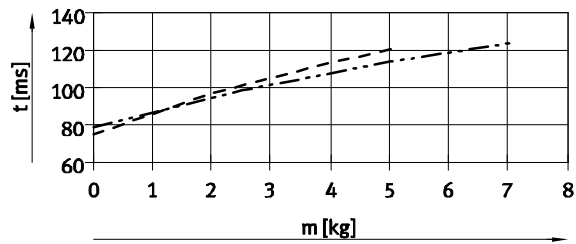

Stroke 30 mm, size 4 ... 10

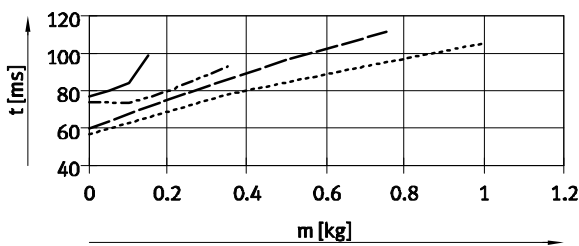

Stroke 30 mm, size 4 ... 10

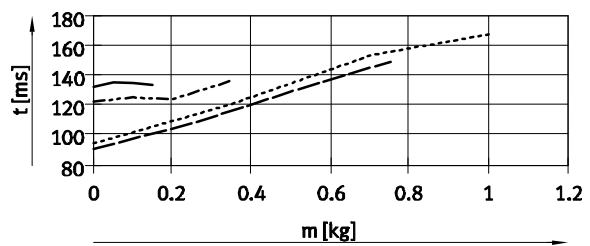

- |         |         |         |         |
|---------|---------|---------|---------|
| —       | DGSL-4  | - - - - | DGSL-12 |
| - - - - | DGSL-6  | - - - - | DGSL-16 |
| - - - - | DGSL-8  | - - - - | DGSL-20 |
| - - - - | DGSL-10 | - - - - | DGSL-25 |



# Mini slides DGSL

Technical data

## Shock absorber selection

Travel time  $t$  as a function of payload  $m$  and cushioning P/E – horizontal mounting position



The values in the graphs are determined by calculation. The travel time as a function of payload must not be reduced below the

values shown, because the kinetic impact or residual energy in the end positions can result in damage to the drive.

Vertical mounting position → 19

### Advancing

Stroke 30 mm, size 12 ... 25

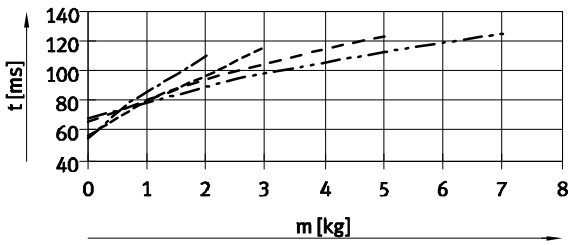

### Retracting

Stroke 30 mm, size 12 ... 16

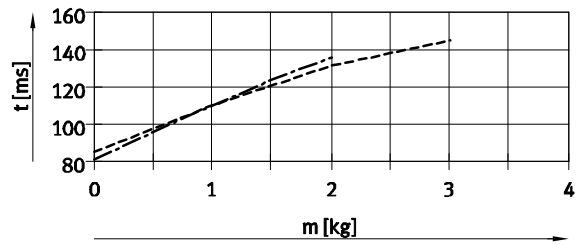

Stroke 30 mm, size 20 ... 25

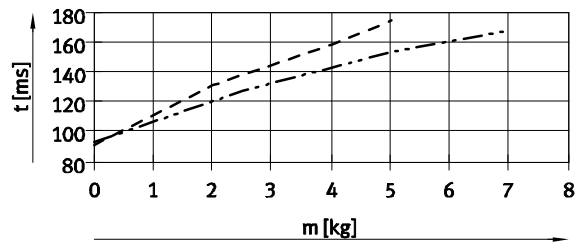

Stroke 50 mm, size 6 ... 12

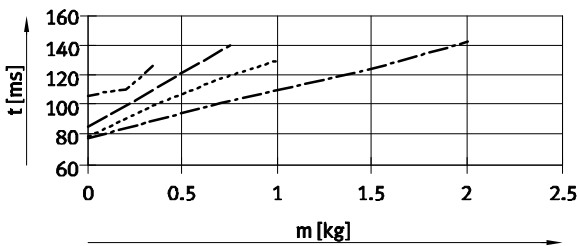

Stroke 50 mm, size 6 ... 12

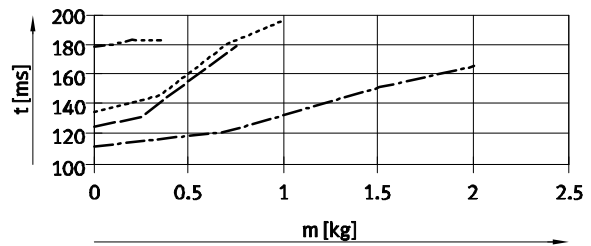

Stroke 50 mm, size 16 ... 25

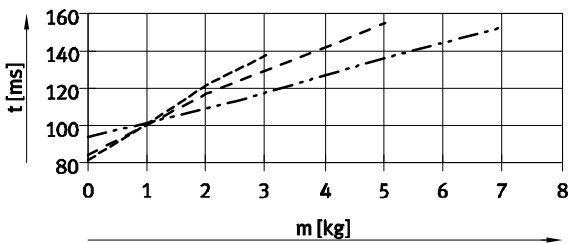

Stroke 50 mm, size 16

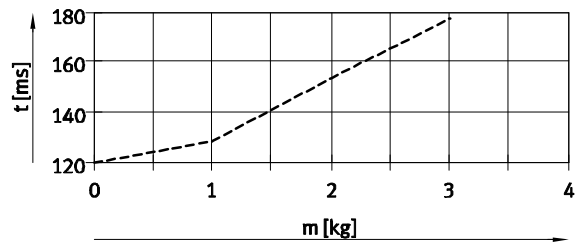

- DGSL-6
- DGSL-8
- DGSL-10
- DGSL-12
- DGSL-16
- DGSL-20
- DGSL-25

Stroke 50 mm, size 20 ... 25

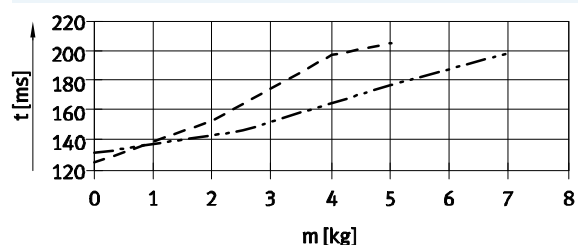

# Mini slides DGSL

Technical data

## Shock absorber selection

Travel time  $t$  as a function of payload  $m$  and cushioning P/E – horizontal mounting position



The values in the graphs are determined by calculation. The travel time as a function of payload must not be reduced below the

values shown, because the kinetic impact or residual energy in the end positions can result in damage to the drive.

Vertical mounting position  
→ 19

### Advancing

Stroke 100 mm, size 10 ... 16

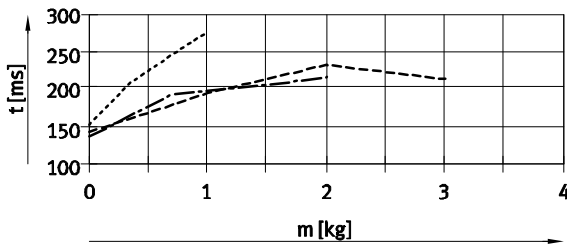

### Retracting

Stroke 100 mm, size 10 ... 16

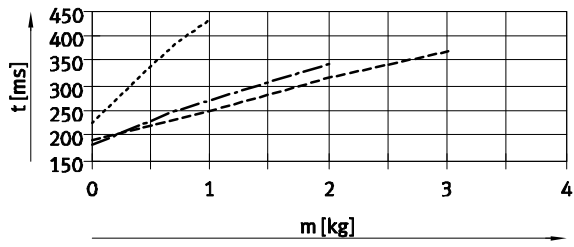

Stroke 100 mm, size 20 ... 25

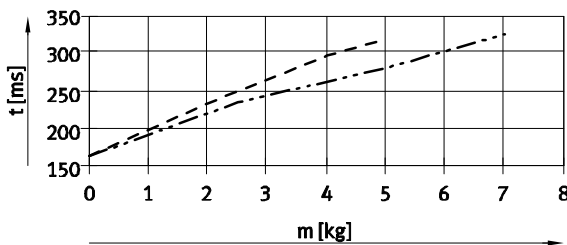

Stroke 100 mm, size 20 ... 25

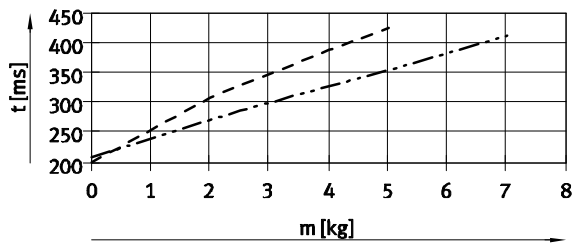

Stroke 150 mm, size 12 ... 16

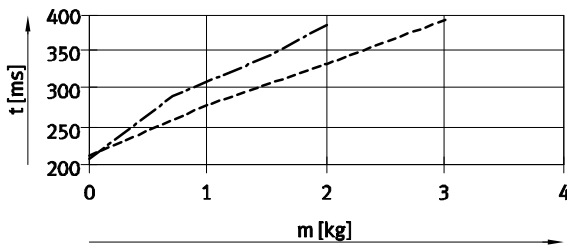

Stroke 150 mm, size 12 ... 16

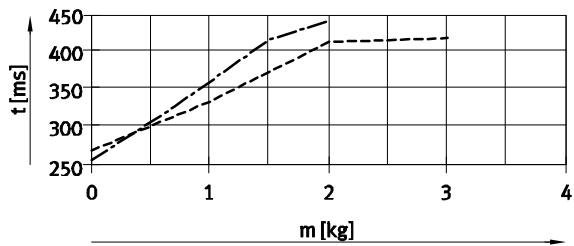

Stroke 150 mm, size 20 ... 25

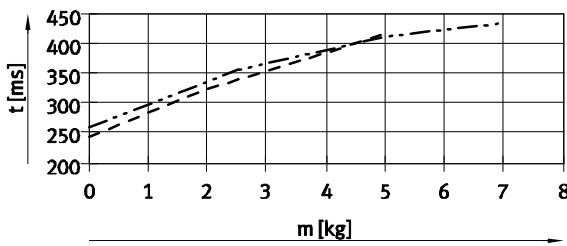

Stroke 150 mm, size 20 ... 25

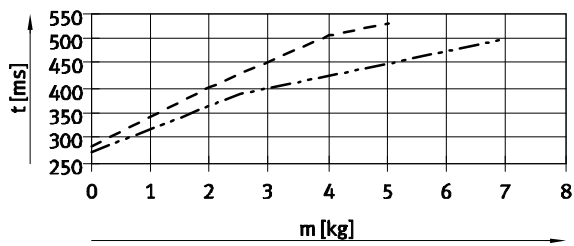

- ..... DGSL-10
- DGSL-12
- DGSL-16
- DGSL-20
- DGSL-25

# Mini slides DGSL

Technical data

## Shock absorber selection

Travel time  $t$  as a function of payload  $m$  and cushioning P/E – horizontal mounting position



The values in the graphs are determined by calculation. The travel time as a function of payload must not be reduced below the

values shown, because the kinetic impact or residual energy in the end positions can result in damage to the drive.

Vertical mounting position → 19

### Advancing

Stroke 200 mm, size 20 ... 25

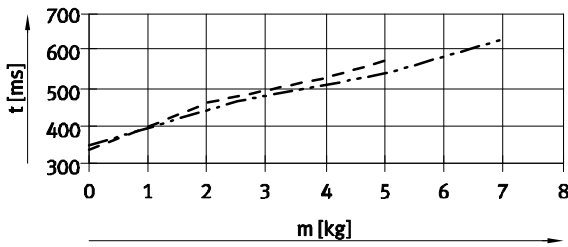

### Retracting

Stroke 200 mm, size 20 ... 25

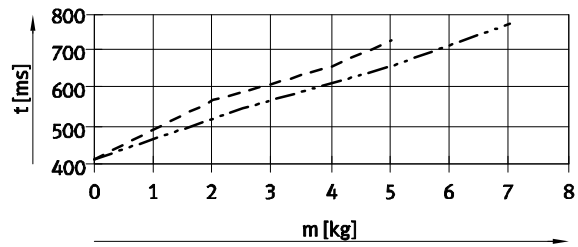

- - - - DGSL-20
- . . . - DGSL-25

## Vertical mounting position

The travel times for a vertical mounting position are calculated by multiplying the data for a horizontal mounting position by a correction factor  $k_a$  (advancing) and  $k_r$  (retracting), see adjacent table.

**Given:**  
 Stroke = 200 mm  
 Size = 20  
 Payload = 3 kg  
 Ascertained travel time  $t_h$  (horizontal), see graph:  
 – Advancing = 500 ms  
 – Retracting = 600 ms  
 Calculated travel time  $t_v$  (vertical):  
 – Advancing:  $t_v = t_h \times k_a$   
 $t_v = 500 \text{ ms} \times 0.9 = 450 \text{ ms}$   
 – Retracting:  $t_v = t_h \times k_r$   
 $t_v = 600 \text{ ms} \times 1.1 = 660 \text{ ms}$

Stroke [mm]	Size	Advancing ( $k_a$ ) <sup>1)</sup>	Retracting ( $k_r$ )
10	4, 6, 8, 10	0.95	1.1
	12, 16, 20, 25	0.95	1.2
30	4, 6, 8, 10	0.95	1.1
	12, 16, 20, 25	0.95	1.2
50	6, 8, 10, 12	0.9	1.1
	16, 20, 25	1.1	1.2
100	10, 12, 16, 20, 25	1	1.1
150	12, 16, 20, 25	1	1.1
200	20, 25	0.9	1.1

1) Downward

# Mini slides DGSL

Technical data



## Shock absorber selection

Travel time  $t$  as a function of payload  $m$  and cushioning P1 – horizontal mounting position



The values in the graphs are determined by calculation. The travel time as a function of payload must not be reduced below the

values shown, because the kinetic impact or residual energy in the end positions can result in damage to the drive.

Vertical mounting position  
→ 23

### Advancing

Stroke 10 mm, size 4 ... 10

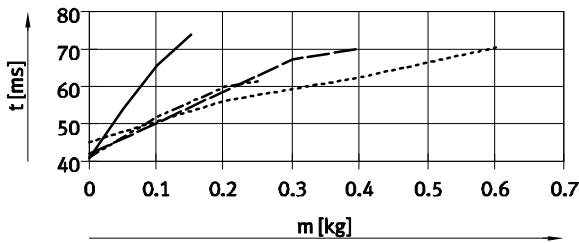

### Retracting

Stroke 10 mm, size 4 ... 10

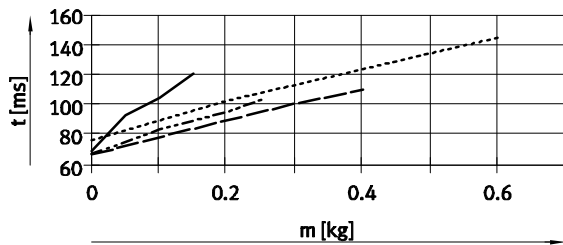

Stroke 10 mm, size 12 ... 16

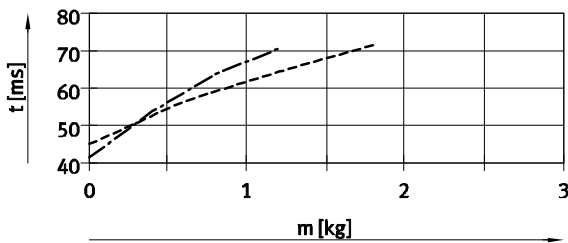

Stroke 10 mm, size 12 ... 16

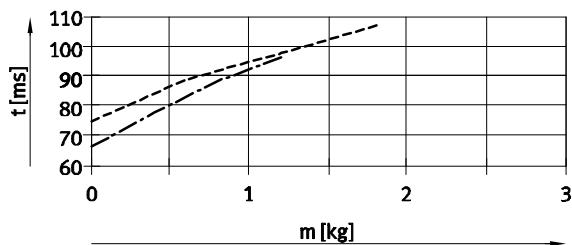

Stroke 10 mm, size 20 ... 25

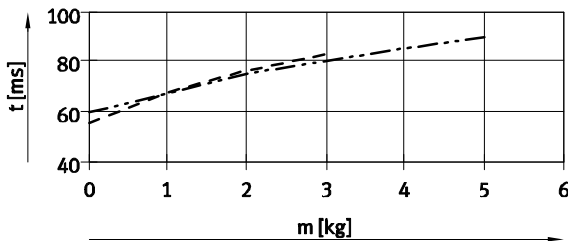

Stroke 10 mm, size 20 ... 25

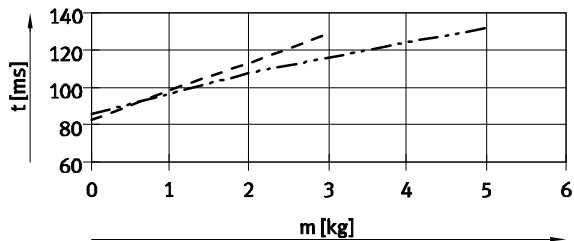

Stroke 30 mm, size 4 ... 10

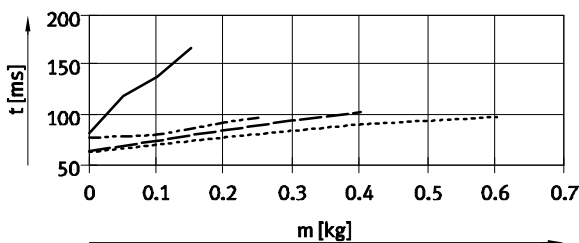

Stroke 30 mm, size 4 ... 10

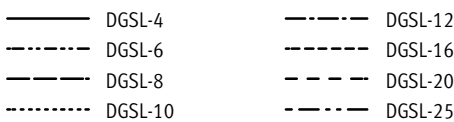
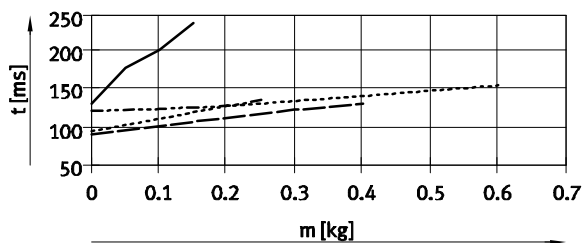

# Mini slides DGSL

Technical data

## Shock absorber selection

Travel time  $t$  as a function of payload  $m$  and cushioning P1 – horizontal mounting position

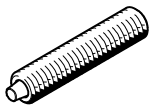

The values in the graphs are determined by calculation. The travel time as a function of payload must not be reduced below the

values shown, because the kinetic impact or residual energy in the end positions can result in damage to the drive.

Vertical mounting position → 23

### Advancing

Stroke 30 mm, size 12 ... 16

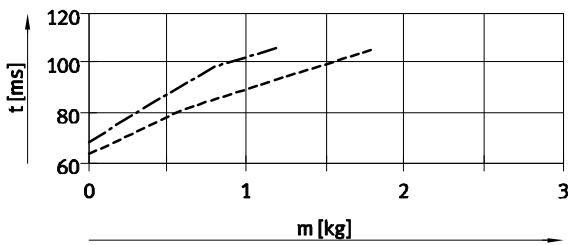

### Retracting

Stroke 30 mm, size 12 ... 16

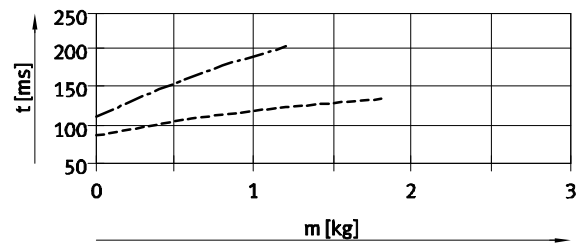

Stroke 30 mm, size 20 ... 25

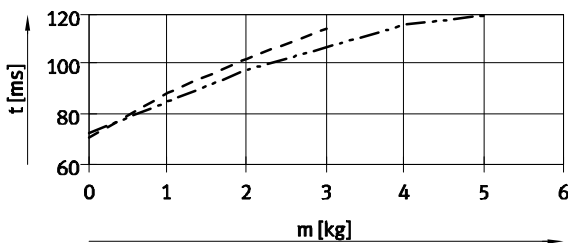

Stroke 30 mm, size 20 ... 25

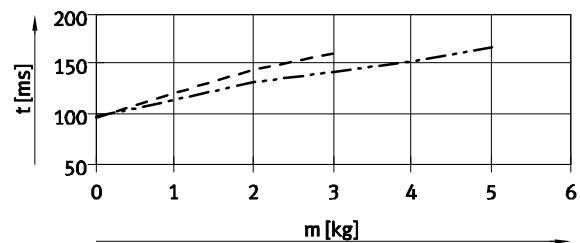

Stroke 50 mm, size 6 ... 12

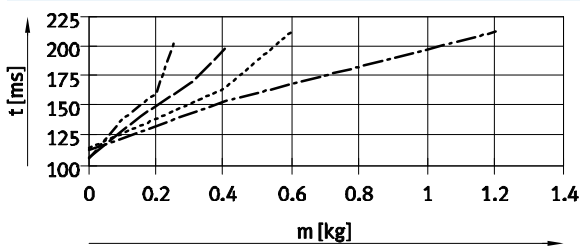

Stroke 50 mm, size 6 ... 12

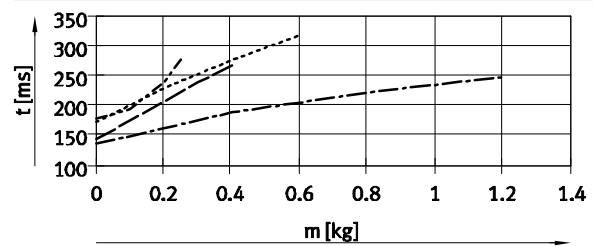

Stroke 50 mm, size 16 ... 25

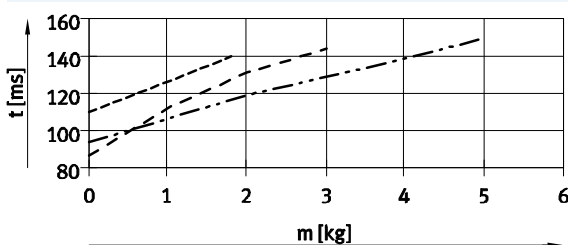

Stroke 50 mm, size 16 ... 25

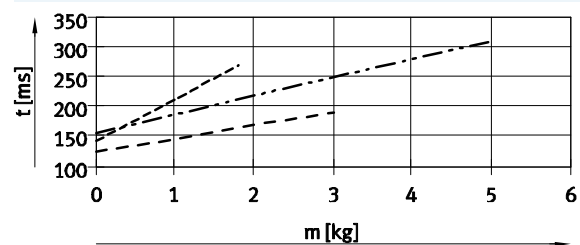

- DGSL-6
- DGSL-8
- DGSL-10
- DGSL-12
- DGSL-16
- DGSL-20
- DGSL-25

# Mini slides DGSL

Technical data



## Shock absorber selection

Travel time  $t$  as a function of payload  $m$  and cushioning P1 – horizontal mounting position

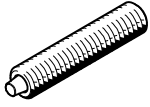

The values in the graphs are determined by calculation. The travel time as a function of payload must not be reduced below the

values shown, because the kinetic impact or residual energy in the end positions can result in damage to the drive.

Vertical mounting position  
→ 23

### Advancing

Stroke 100 mm, size 10 ... 16

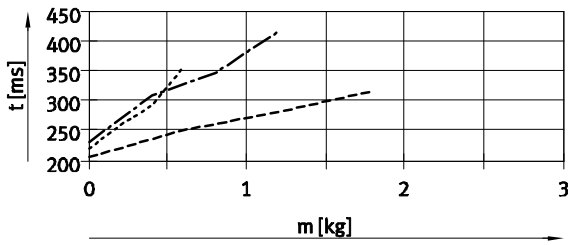

### Retracting

Stroke 100 mm, size 10 ... 25

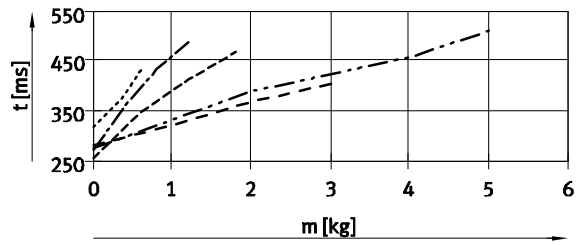

Stroke 100 mm, size 20 ... 25

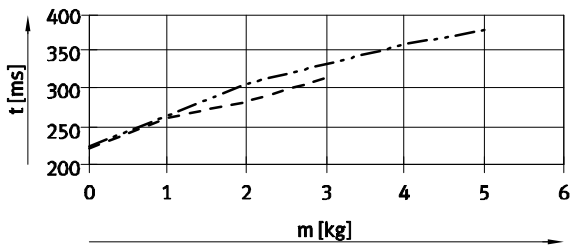

Stroke 150 mm, size 12 ... 25

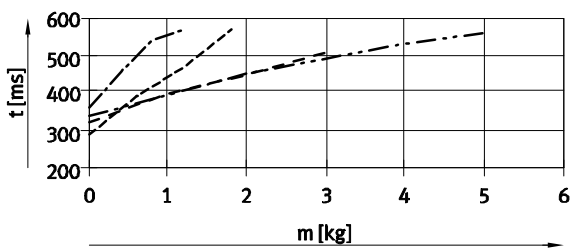

Stroke 150 mm, size 12 ... 25

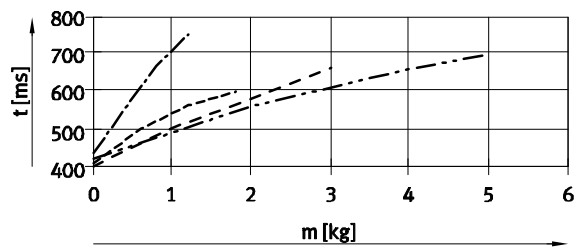

- ..... DGSL-10
- · - · - DGSL-12
- DGSL-16
- DGSL-20
- · - · - DGSL-25

# Mini slides DGSL

Technical data

## Shock absorber selection

Travel time  $t$  as a function of payload  $m$  and cushioning P1 – horizontal mounting position

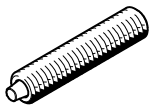

The values in the graphs are determined by calculation. The travel time as a function of payload must not be reduced below the

values shown, because the kinetic impact or residual energy in the end positions can result in damage to the drive.

Vertical mounting position  
→ 23

### Advancing

Stroke 200 mm, size 20

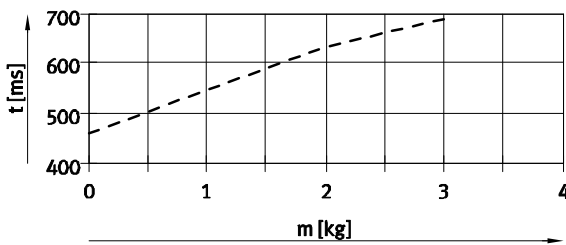

### Retracting

Stroke 200 mm, size 20

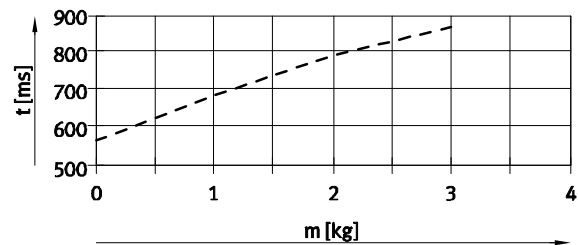

Stroke 200 mm, size 25

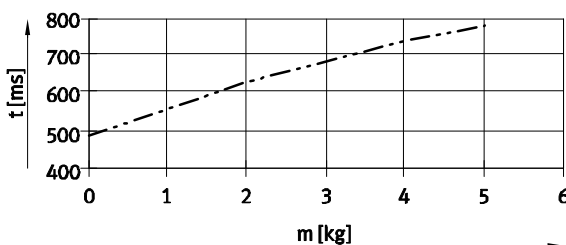

Stroke 200 mm, size 25

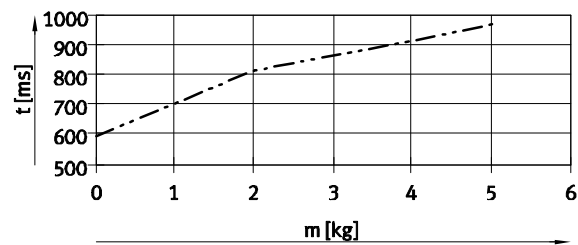

- DGSL-20
- - - - - DGSL-25

## Vertical mounting position

The travel times for a vertical mounting position are calculated by multiplying the data for a horizontal mounting position by a correction factor  $k_a$  (advancing) and  $k_r$  (retracting), see adjacent table.

**Given:**  
 Stroke = 200 mm  
 Size = 20  
 Payload = 2 kg  
 Ascertained travel time  $t_h$  (horizontal), see graph:  
 – Advancing = 640 ms  
 – Retracting = 780 ms  
 Calculated travel time  $t_v$  (vertical):  
 – Advancing:  $t_v = t_h \times k_a$   
 $t_v = 640 \text{ ms} \times 0.9 = 576 \text{ ms}$   
 – Retracting:  $t_v = t_h \times k_r$   
 $t_v = 780 \text{ ms} \times 1.1 = 858 \text{ ms}$

Stroke [mm]	Size	Advancing ( $k_a$ ) <sup>1)</sup>	Retracting ( $k_r$ )
10	4, 6, 8, 10	1	1.1
	12, 16, 20, 25	1.1	1.2
30	4, 6, 8, 10	1	1.1
	12, 16, 20, 25	1.1	1.2
50	6, 8, 10, 12	1	1.1
	16, 20, 25	0.9	1.1
100	10, 12, 16, 20, 25	0.95	1.1
150	12, 16, 20, 25	0.95	1.1
200	20, 25	0.9	1.1

1) Downward

# Mini slides DGSL

Technical data

FESTO

## Shock absorber selection

Travel time  $t$  as a function of payload  $m$  and cushioning Y3 – horizontal mounting position

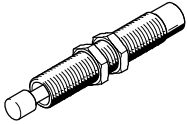

The values in the graphs are determined by calculation. The travel time as a function of payload must not be reduced below the

values shown, because the kinetic impact or residual energy in the end positions can result in damage to the drive.

Vertical mounting position  
→ 25

### Advancing

Stroke 30 mm, size 8 ... 12

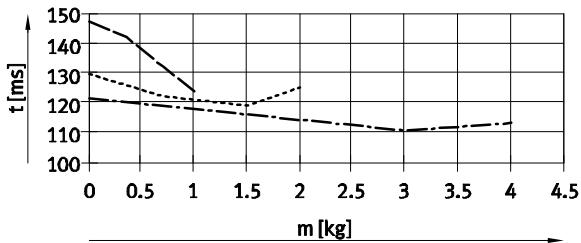

### Retracting

Stroke 30 mm, size 8 ... 12

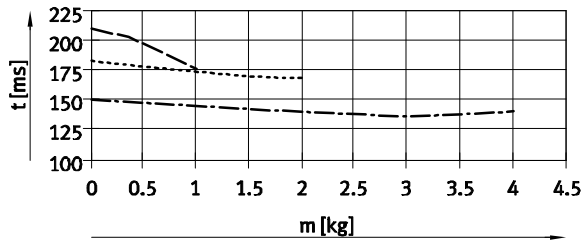

Stroke 30 mm, size 16 ... 25

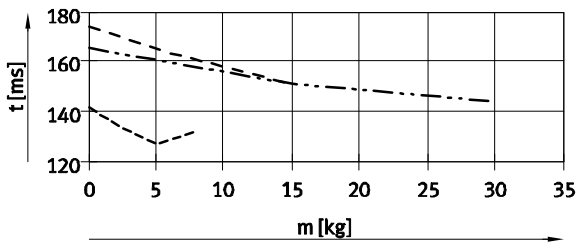

Stroke 30 mm, size 16 ... 25

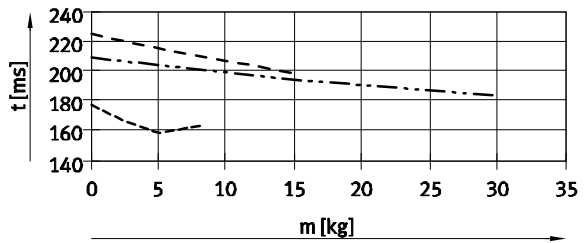

Stroke 50 mm, size 8 ... 12

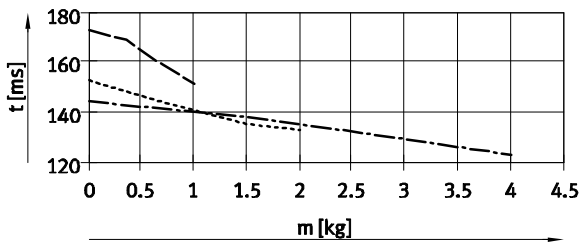

Stroke 50 mm, size 8 ... 12

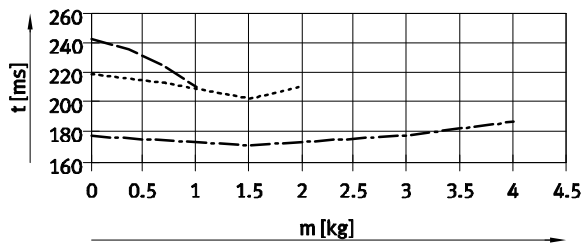

Stroke 50 mm, size 16 ... 25

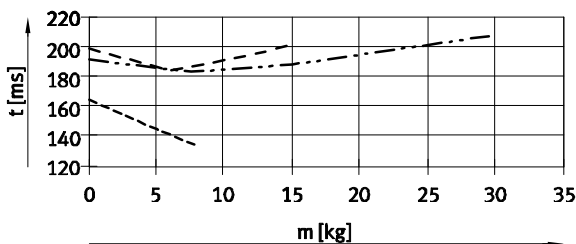

Stroke 50 mm, size 16 ... 25

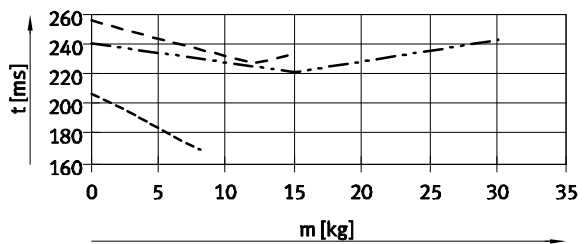

- DGSL-8
- DGSL-10
- · - DGSL-12
- DGSL-16
- DGSL-20
- · - DGSL-25



# Mini slides DGSL

Technical data

## Shock absorber selection

Travel time  $t$  as a function of payload  $m$  and cushioning Y3 – horizontal mounting position

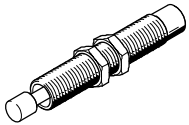

The values in the graphs are determined by calculation. The travel time as a function of payload must not be reduced below the

values shown, because the kinetic impact or residual energy in the end positions can result in damage to the drive.

Vertical mounting position  
→ 25

### Advancing

Stroke 100 mm, size 10 ... 25

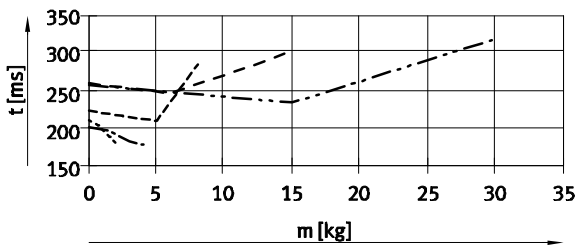

### Retracting

Stroke 100 mm, size 10 ... 25

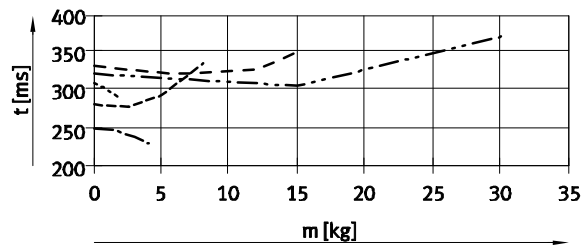

Stroke 150 mm, size 12 ... 25

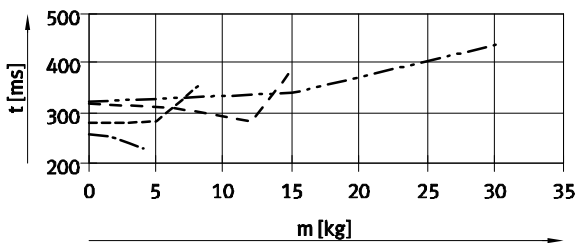

Stroke 150 mm, size 12 ... 25

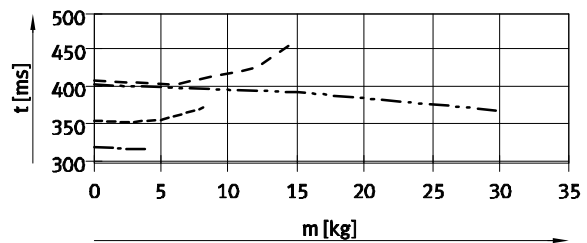

Stroke 200 mm, size 20 ... 25

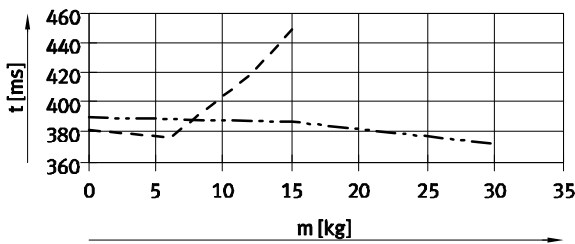

Stroke 200 mm, size 20 ... 25

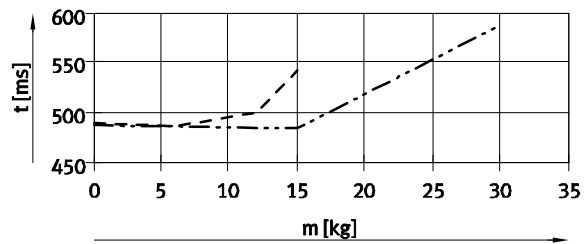

- ..... DGSL-10
- DGSL-12
- DGSL-16
- DGSL-20
- DGSL-25

### Vertical mounting position

The travel times for a vertical mounting position are calculated by multiplying the data for a horizontal mounting position by a correction factor  $k_a$  (advancing) and  $k_r$  (retracting), see adjacent table.

**Given:**  
 Stroke = 200 mm  
 Size = 20  
 Payload = 10 kg  
 Ascertained travel time  $t_h$  (horizontal), see graph:  
 – Advancing = 405 ms  
 – Retracting = 490 ms  
 Calculated travel time  $t_v$  (vertical):  
 – Advancing:  $t_v = t_h \times k_a$   
 $t_v = 405 \text{ ms} \times 0.9 = 365 \text{ ms}$   
 – Retracting:  $t_v = t_h \times k_r$   
 $t_v = 490 \text{ ms} \times 1.5 = 735 \text{ ms}$

Stroke [mm]	Size	Advancing ( $k_a$ ) <sup>1)</sup>	Retracting ( $k_r$ )
30	8, 10, 12	0.95	1.2
	16, 20, 25	0.9	1.5
50	8, 10, 12	0.9	1.5
	16, 20, 25	0.9	1.5
100	10, 12, 16, 20, 25	0.8	1.5
150	12, 16, 20, 25	0.9	1.5
200	20, 25	0.9	1.5

1) Downward

# Mini slides DGSL

Technical data



## Dynamic characteristic load values

Torques are indicated with reference to the centre of the guide.  
These values must not be exceeded during dynamic operation. Special attention must be paid to the cushioning phase.

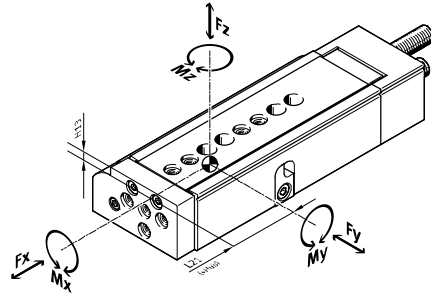

If the drive is simultaneously subjected to several of the indicated forces and torques, the following equation must be satisfied in addition to the indicated maximum loads:

$$\frac{|F_y|}{F_{y_{max}}} + \frac{|F_z|}{F_{z_{max}}} + \frac{|M_x|}{M_{x_{max}}} + \frac{|M_y|}{M_{y_{max}}} + \frac{|M_z|}{M_{z_{max}}} \leq 1$$

## Position of the guide centre

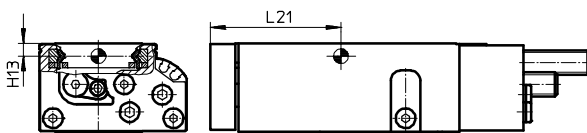

## Calculation example

Given:

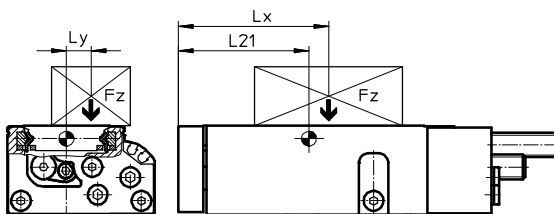

To be calculated:

Mini slide = DGSL-10  
Stroke length = 80 mm  
Lever arm  $L_x$  = 50 mm  
Lever arm  $L_y$  = 30 mm  
Load  $F_z$  = 0.8 kg  
Acceleration  $a$  = 0 m/s<sup>2</sup>

$F_y, F_z, M_x, M_y, M_z$   
and  
verification of operation with combined load

Solution:

$L_{21} = 83$  mm from table

$F_y = 0$  N

$F_z = m \times g$   
 $= 0.8 \text{ kg} \times 9.81 \text{ m/s}^2 = 7.848$  N

$M_x = m \times g \times L_y$   
 $= 0.8 \text{ kg} \times 9.81 \text{ m/s}^2 \times 30 \text{ mm} = 0.236$  Nm

$M_y = m \times g \times [(L_{21} + \text{stroke}) - L_x]$   
 $= 0.8 \text{ kg} \times 9.81 \text{ m/s}^2 \times [(83 \text{ mm} + 80 \text{ mm}) - 50 \text{ mm}] = 0.886$  Nm

$M_z = 0$  Nm

Combined load:

$$\frac{|F_y|}{F_{y_{max}}} + \frac{|F_z|}{F_{z_{max}}} + \frac{|M_x|}{M_{x_{max}}} + \frac{|M_y|}{M_{y_{max}}} + \frac{|M_z|}{M_{z_{max}}}$$

$$= 0 + \frac{7.848 \text{ N}}{1200 \text{ N}} + \frac{0.236 \text{ Nm}}{18 \text{ Nm}} + \frac{0.886 \text{ Nm}}{12 \text{ Nm}} + 0 = 0.094 \leq 1$$

Permissible forces and torques						Geometric characteristics	
Size	Stroke [mm]	$F_{y_{max}}$ [N]	$F_{z_{max}}$ [N]	$M_{x_{max}}$ [Nm]	$M_{y_{max}}, M_{z_{max}}$ [Nm]	H13 [mm]	L21 [mm]
4	10	343	343	2	2	2.7	31
	20	368	368	2	2		36
	30	387	387	2	2		42
6	10	540	540	6	4.5	3.4	37
	20	590	590	7	5		42
	30	631	631	8	5.5		47
	40	677	677	8	5.5		52
	50	719	719	8	5.5		57

# Mini slides DGSL

Technical data



Permissible forces and torques						Geometric characteristics	
Size	Stroke [mm]	F <sub>y</sub> max [N]	F <sub>z</sub> max [N]	M <sub>x</sub> max [Nm]	M <sub>y</sub> max, M <sub>z</sub> max [Nm]	H13 [mm]	L21 [mm]
<b>8</b>							
	10	657	657	7	5.5	3.25	41
	20	745	745	8	5.5		46
	30	850	850	9	5.5		51
	40	934	934	10	5.5		56
	50	962	962	10	8		67
	80	971	971	10	8		82
<b>10</b>							
	10	927	927	15	6	4.2	43
	20	1,003	1,003	15	7		46
	30	1,078	1,078	15	8		51
	40	1,152	1,152	15	9		56
	50	1,175	1,175	18	9		61
	80	1,200	1,200	18	12		83
	100	1,250	1,250	18	12		96
<b>12</b>							
	10	942	942	15	8	5.2	44
	20	1,006	1,006	15	9		49
	30	1,075	1,075	15	10		54
	40	1,142	1,142	18	11		59
	50	1,200	1,200	18	12		64
	80	1,280	1,280	20	15		88
	100	1,340	1,340	20	15		98
	150	1,400	1,400	20	15		124
<b>16</b>							
	10	1,769	1,769	35	20	6.4	54
	20	2,021	2,021	35	22		59
	30	2,274	2,274	35	22		64
	40	2,527	2,527	40	25		69
	50	2,780	2,780	40	25		74
	80	2,800	2,800	50	27		89
	100	2,850	2,850	50	43		113
	150	2,900	2,900	50	43		138
<b>20</b>							
	10	2,911	2,911	60	30	7.55	56
	20	3,143	3,143	60	30		61
	30	3,354	3,354	60	30		66
	40	3,612	3,612	60	40		71
	50	3,816	3,816	70	50		76
	80	4,032	4,032	80	50		91
	100	4,200	4,200	85	80		121
	150	4,400	4,400	90	80		152
	200	4,600	4,600	90	80		177
<b>25</b>							
	10	3,270	3,270	100	60	8.55	64
	20	3,744	3,744	100	60		69
	30	4,205	4,205	100	60		74
	40	4,643	4,643	110	60		79
	50	4,650	4,650	120	60		84
	80	4,700	4,700	130	80		112
	100	4,750	4,750	130	80		129
	150	4,800	4,800	130	80		154
	200	4,800	4,800	130	80		179

# Mini slides DGSL

Technical data



## Dimensions

Download CAD data → [www.festo.com](http://www.festo.com)

Size 4 ... 10

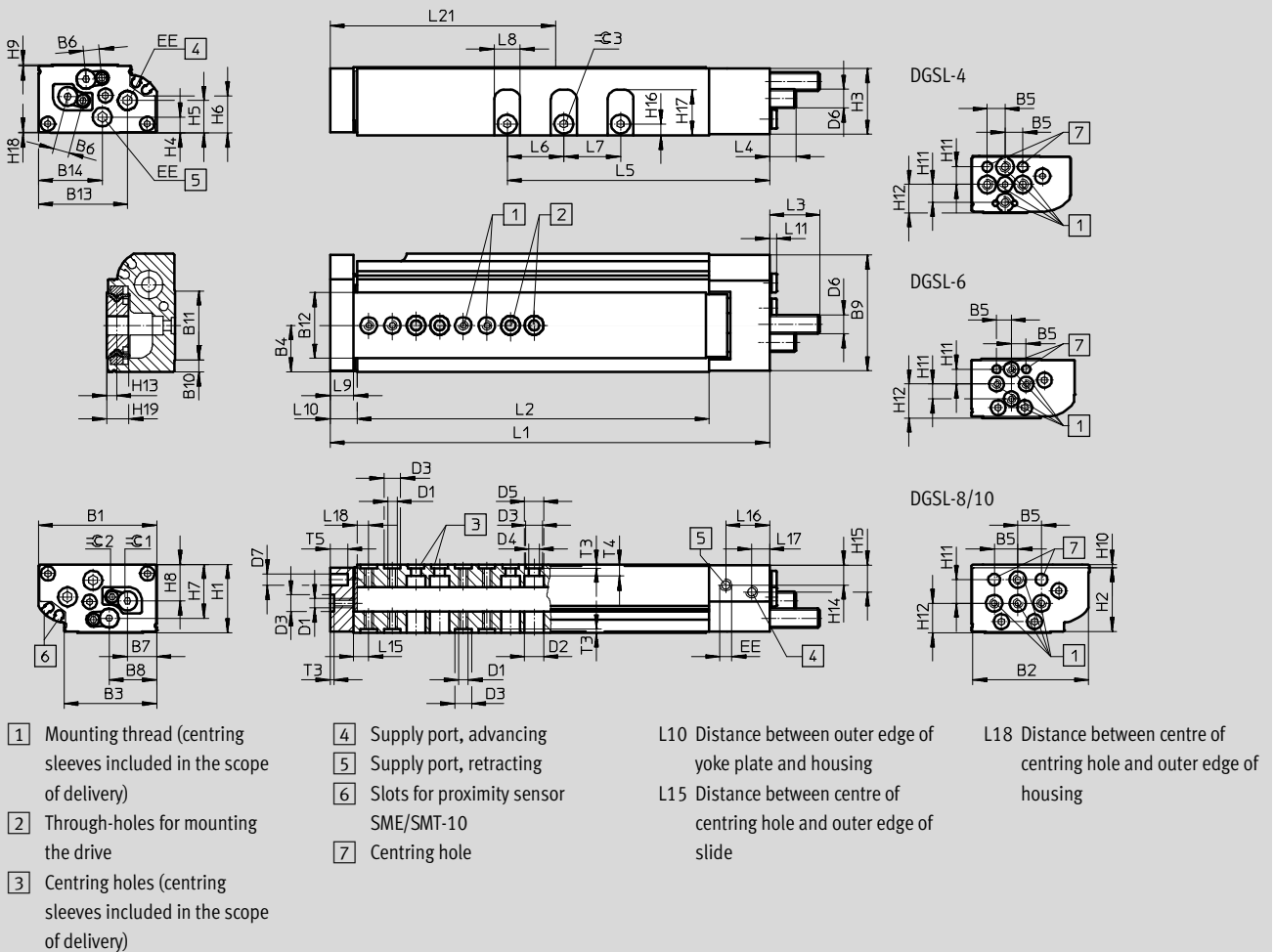

## General dimensions

Size	B1	B2	B3	B4	B5	B6	B7	B8	B9	B10	B11	B12	B13	B14	D1
4	28	27.4	18.35	9.4	5	3.55	6.3	11.95	27.5	2	17.2	12.4	23.15	16.15	M3
6	35	34.5	26.3	13.5	5	5	8.2	13.55	34.5	3.5	19.9	20	28.1	18.9	M3
8	42	41.3	31.45	16.6	10	6	10.3	16.25	41.5	4.57	24	24.1	33	24.4	M4
10	50	49	39.2	19.65	10	6.8	12.35	20.1	49	5	29.2	28	37.7	27	M4

Size	D2 ∅	D3 ∅	D4 ∅	D5 ∅	D6	D7 ∅	EE	H1 ±0.08	H2	H3	H4	H5	H6	H7	H8
4	6.3	5 <sup>H7</sup>	3.3	6.2	M4x0.5	3 <sup>H7</sup>	M3	16	15.4	15.1	3.85	6.25	8.55	8.1	8.4
6	6.3	5 <sup>H7</sup>	3.3	6.2	M5x0.5	3 <sup>H7</sup>	M3	20	19	19.25	4.7	7.8	10.2	16.05	10.55
8	8.2	7 <sup>H7</sup>	4.3	8	M6x0.5	5 <sup>H7</sup>	M3	24	22.7	23	6.46	10.63	14.06	18.9	13.3
10	8.2	7 <sup>H7</sup>	4.3	8	M8x1	5 <sup>H7</sup>	M5	29	27.1	28	6.8	13.8	15.8	22.8	15.5

Size	H9	H10	H11	H12	H13	H14	H15	H16	H17	H18	H19	T3 +0.1	T4	T5	⌀2 <sup>1)</sup>	⌀3
4	0.65	0.3	5	8	2.7	5.35	5.85	3.1	10.6	0.25	5.28	1.3	2.25	4	1.3	2
6	0.45	0.5	5	11.5	3.38	6.5	7.2	3.7	13.1	0.3	6.68	1.3	3.7	6	1.5	2.5
8	0.64	0.9	10	8.7	3.28	7.8	10.5	4.1	16.8	0.36	6.7	1.6	3.8	7.5	2	2.5
10	0.6	1.4	10	12.5	4.2	8.76	11.76	4.8	19.25	0.41	9	1.6	5.35	7.5	2.5	3

1) With size 4, the scope of delivery of the drive includes an Allen key

# Mini slides DGSL

Technical data



Stroke-dependent dimensions															
Size	Stroke	L1	L2	L5	L6	L7	L8	L9	L10	L11	L15 ±0.05	L16	L17	L18 ±0.05	L21
4	10	72.1	48	28.85	–	–	6.5	5.5	6.6	2.5	4	13.25	4.95	3	31
	20	81.2	57.1	37.95	10										36
	30	91.2	67.1	47.95	11										42
6	10	81.1	54	33.1	–	–	8	8	9.6	2.5	5.1	13.25	4.95	3.5	37
	20	91.1	64	43.1	14										42
	30	101.1	74	53.1	–										47
	40	111.1	84	63.1	–										52
	50	121.1	94	73.1	–										57
8	10	90.2	59.6	34.6	–	–	8	10	11.6	2.5	7	14.65	6.1	5.5	41
	20	100.2	69.6	44.6	10										46
	30	110.2	79.6	54.6	16										51
	40	120.2	89.6	64.6	–										56
	50	142.2	111.6	74.6	–										67
	80	172.2	141.6	104.6	16										82
10	10	103.1	66	41.3	–	–	11	10	11.6	2.5	6.4	18.5	7.5	5	43
	20	112.8	75.7	51	–										46
	30	122.8	85.7	61	–										51
	40	132.8	95.7	71	–										56
	50	142.8	105.7	81	–										61
	80	186.2	149.1	111	24										83
	100	206.2	169.1	131	24										24

Cushioning-dependent dimensions					
Size	Cushioning	L3 max.	L4 max.	≈ 1	
				For adjusting the cushioning stroke	For adjusting the end position
4	P	15.2	7.8	–	1.3
	E	5.7	0	–	1.3
	P1	14	6	1.3	2.5
6	P	17.6	8.1	–	1.5
	E	6.6	0	–	1.5
	P1	15.5	5.8	1.5	3
8	P	21.1	10.7	–	2
	E	6.6	0	–	2
	P1	19	9.1	2	4
	Y3	24.3	23.9	–	2
10	P	22.8	12.5	–	2.5
	E	8.8	0	–	2.5
	P1	20.5	10.2	2.5	5
	Y3	25.5	14.9	–	2.5
	Y11	30.4	19.9	–	2

# Mini slides DGSL

Technical data

FESTO

## Hole pattern for mounting threads and centring holes

DGSL-4-10

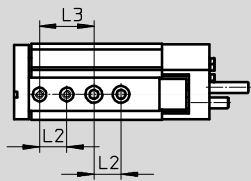

DGSL-4-20

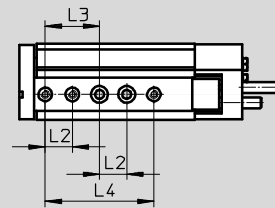

DGSL-4-30

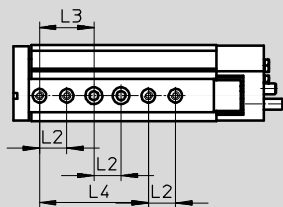

DGSL-6-10

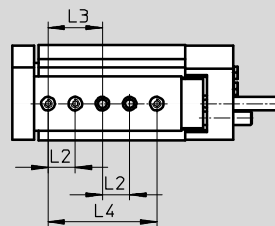

DGSL-6-20

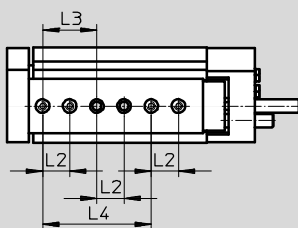

DGSL-6-30

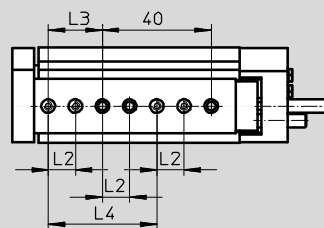

DGSL-6-40/50

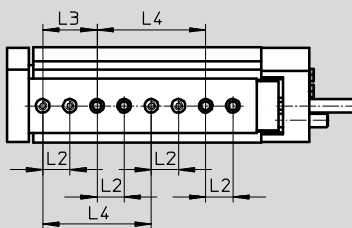

DGSL-8-10

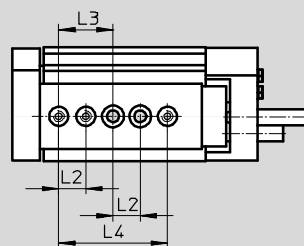

DGSL-8-20

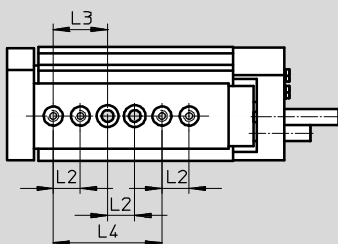

DGSL-8-30

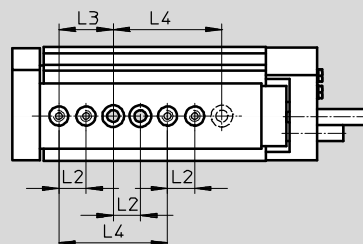

# Mini slides DGSL

Technical data

## Hole pattern for mounting threads and centring holes

DGSL-8-40

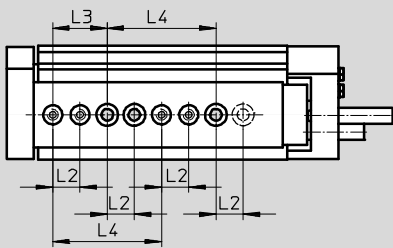

DGSL-8-50/80

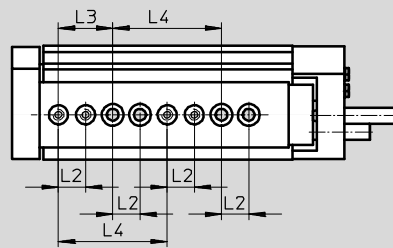

DGSL-10-10

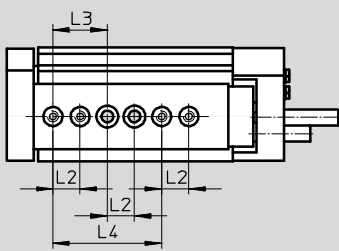

DGSL-10-20

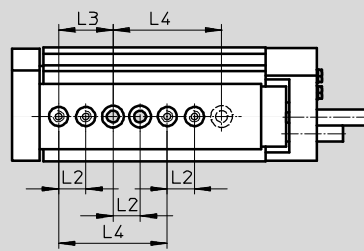

DGSL-10-30

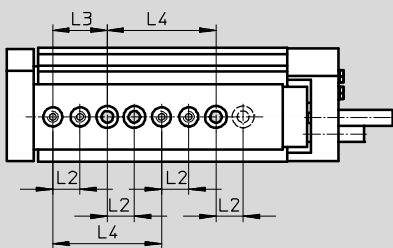

DGSL-10-40 ... 100

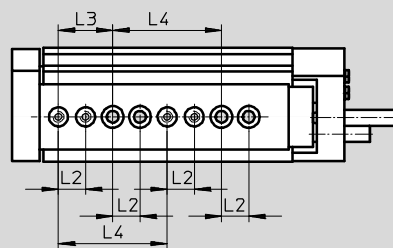

## Distances from yoke plate to mounting threads and centring holes

DGSL-4 ... 10

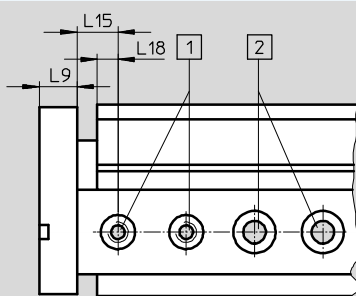

- 1 Centring holes with thread
- 2 Through-holes for mounting the drive

Size	L2 <sup>1)</sup>	L3 <sup>1)</sup>	L4 <sup>1)</sup>	L9	L15 ±0.05	L18
4	10	20	40	5.5	4	3
6	10	20	40	8	5.1	3.5
8	10	20	40	10	7	5.5
10	10	20	40	10	6.4	5

1) Tolerance for centring hole ±0.02  
Tolerance for through-hole ±0.1

# Mini slides DGSL

Technical data

FESTO

## Dimensions

Download CAD data → [www.festo.com](http://www.festo.com)

Size 12/16

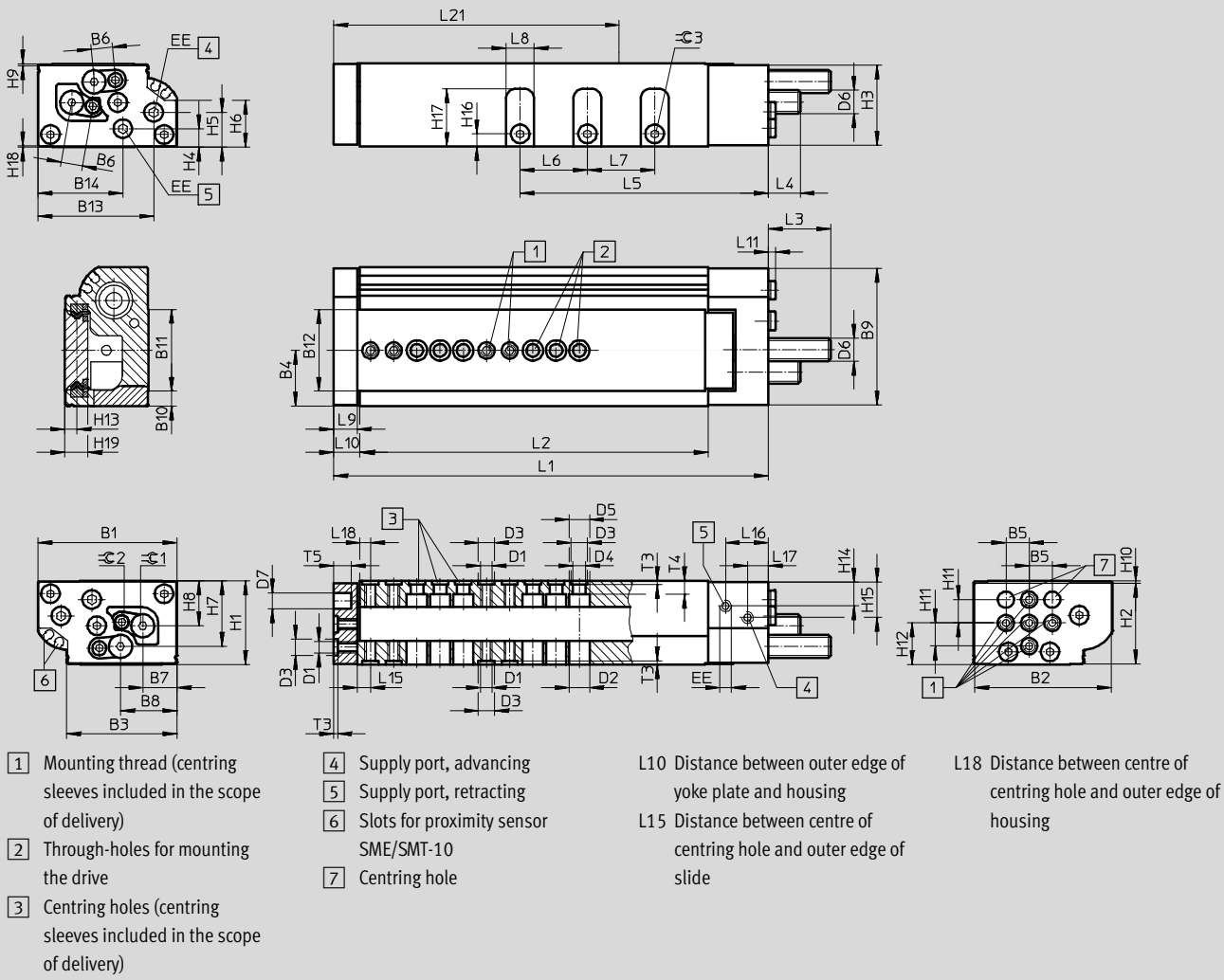

## General dimensions

Size	B1	B2	B3	B4	B5	B6	B7	B8	B9	B10	B11	B12	B13	B14	D1
12	60	59	47.6	24	10	9.2	14.7	24.3	59	6.45	35.25	35.2	50	36.7	M5
16	66	65	53.5	26.7	10	11.1	16.7	27.5	65	7.75	37.9	38	50.4	36.7	M5

Size	D2	D3	D4	D5	D6	D7	EE	H1	H2	H3	H4	H5	H6	H7	H8
	∅	∅	∅	∅		∅		±0.08							
12	9	7 <sup>H7</sup>	5.5	9	M10x1	8 <sup>H7</sup>	M5	36	34.8	34.7	8	15.1	20.35	28.2	19.3
16	9	7 <sup>H7</sup>	5.5	9	M12x1	8 <sup>H7</sup>	M5	40	38	39	8.5	16.7	20.6	31.7	20.8

Size	H9	H10	H11	H12	H13	H14	H15	H16	H17	H18	H19	T3	T4	T5	∅ 2	∅ 3
												+0.1				
12	0.8	0.95	10	17.9	5.2	10.75	15.75	5.5	24.9	0.5	10.1	1.6	5.6	7.5	3	3
16	0.5	1.5	10	20	6.4	10.5	16.7	7	26.6	0.5	12.5	1.6	6.1	9	4	4



# Mini slides DGSL

Technical data



Stroke-dependent dimensions															
Size	Stroke	L1	L2	L5	L6	L7	L8	L9	L10	L11	L15 ±0.05	L16	L17	L18 ±0.05	L21
12	10	106.2	68.6	42.4	-	-	12	10	11.6	2.5	5.8	18.5	9	4.5	44
	20	116.2	78.6	52.4											49
	30	126.2	88.6	62.4											54
	40	136.2	98.6	72.4											59
	50	146.2	108.6	82.4	29										64
	80	197.6	160	112.4											88
	100	217.6	180	132.4											98
	150	267.6	230	182.4											124
16	10	124.1	82.5	45	-	-	14	12	13.6	2.5	6.8	21	10	5.5	54
	20	134.6	93	54.6											59
	30	144.6	103	64.6											64
	40	154.6	113	74.6											69
	50	164.6	123	84.6	35										74
	80	194.6	153	114.6											89
	100	243.6	202	134.6											113
	150	293.6	252	184.6											138

Cushioning-dependent dimensions					
Size	Cushioning	L3 max.	L4 max.	≈ 1	
				For adjusting the cushioning stroke	For adjusting the end position
12	P	28.1	14.9	-	3
	E	8.8	0	-	3
	P1	26	12.8	3	6
	Y3	36.9	23.7	-	3
	Y11	42.2	18.7	-	2.5
16	P	42.3	26.1	-	4
	E	8.8	0	-	4
	P1	40	23.8	4	8
	Y3	51.9	35.7	-	4
	Y11	55.4	38.9	-	3

# Mini slides DGSL

Technical data

FESTO

## Hole pattern for mounting threads and centring holes

DGSL-12-10

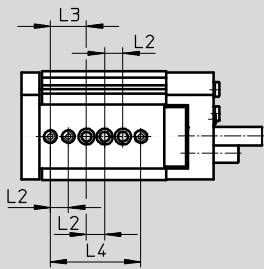

DGSL-12-20

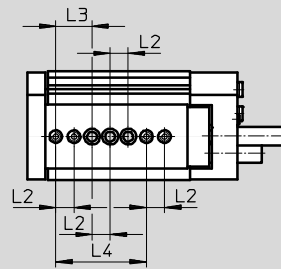

DGSL-12-30

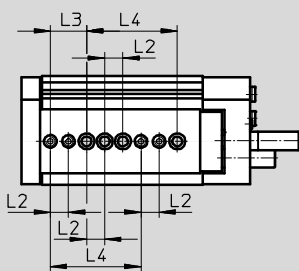

DGSL-12-40

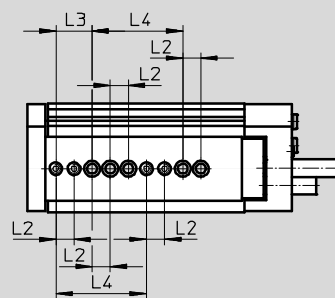

DGSL-12-50 ... 100

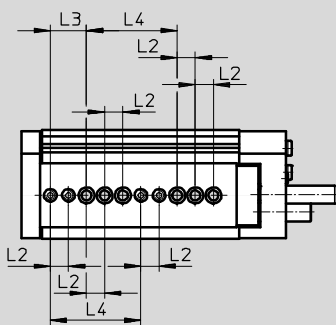

DGSL-12-150

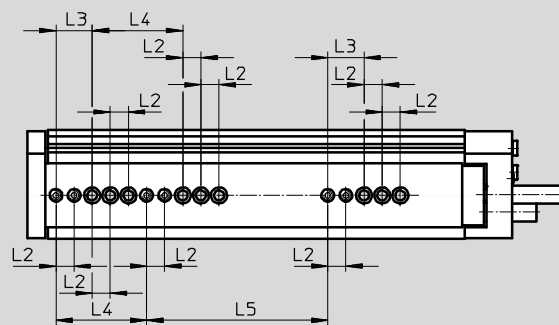

DGSL-16-10

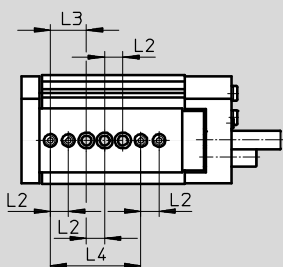

DGSL-16-20

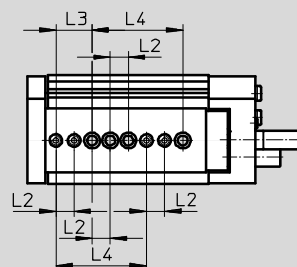

# Mini slides DGSL

Technical data

## Hole pattern for mounting threads and centring holes

DGSL-16-30

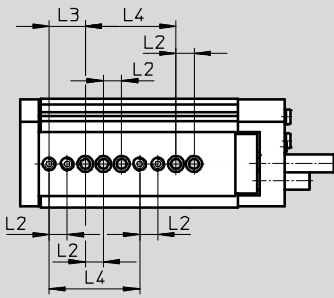

DGSL-16-40 ... 100

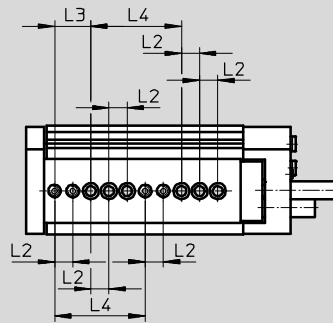

DGSL-16-150

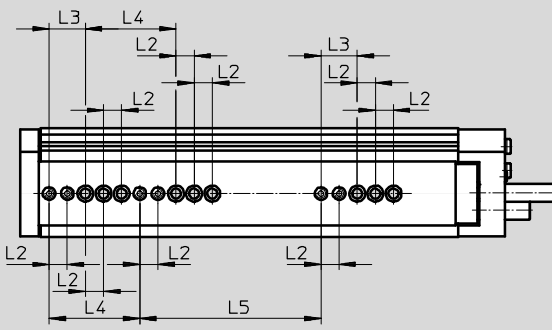

## Distances from yoke plate to mounting threads and centring holes

DGSL-12/16

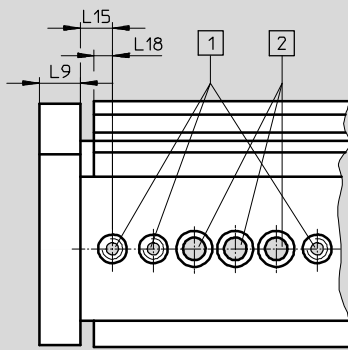

- 1 Centring holes with thread
- 2 Through-holes for mounting the drive

Size	L2 <sup>1)</sup>	L3 <sup>1)</sup>	L4 <sup>1)</sup>	L5 ±0.03	L9	L15 ±0.05	L18 ±0.05
12	10	20	50	100	10	5.8	4.5
16	10	20	50	100	12	6.8	5.5

1) Tolerance for centring hole ±0.02  
Tolerance for through-hole ±0.1

# Mini slides DGSL

Technical data



## Dimensions

Download CAD data → [www.festo.com](http://www.festo.com)

Size 20/25

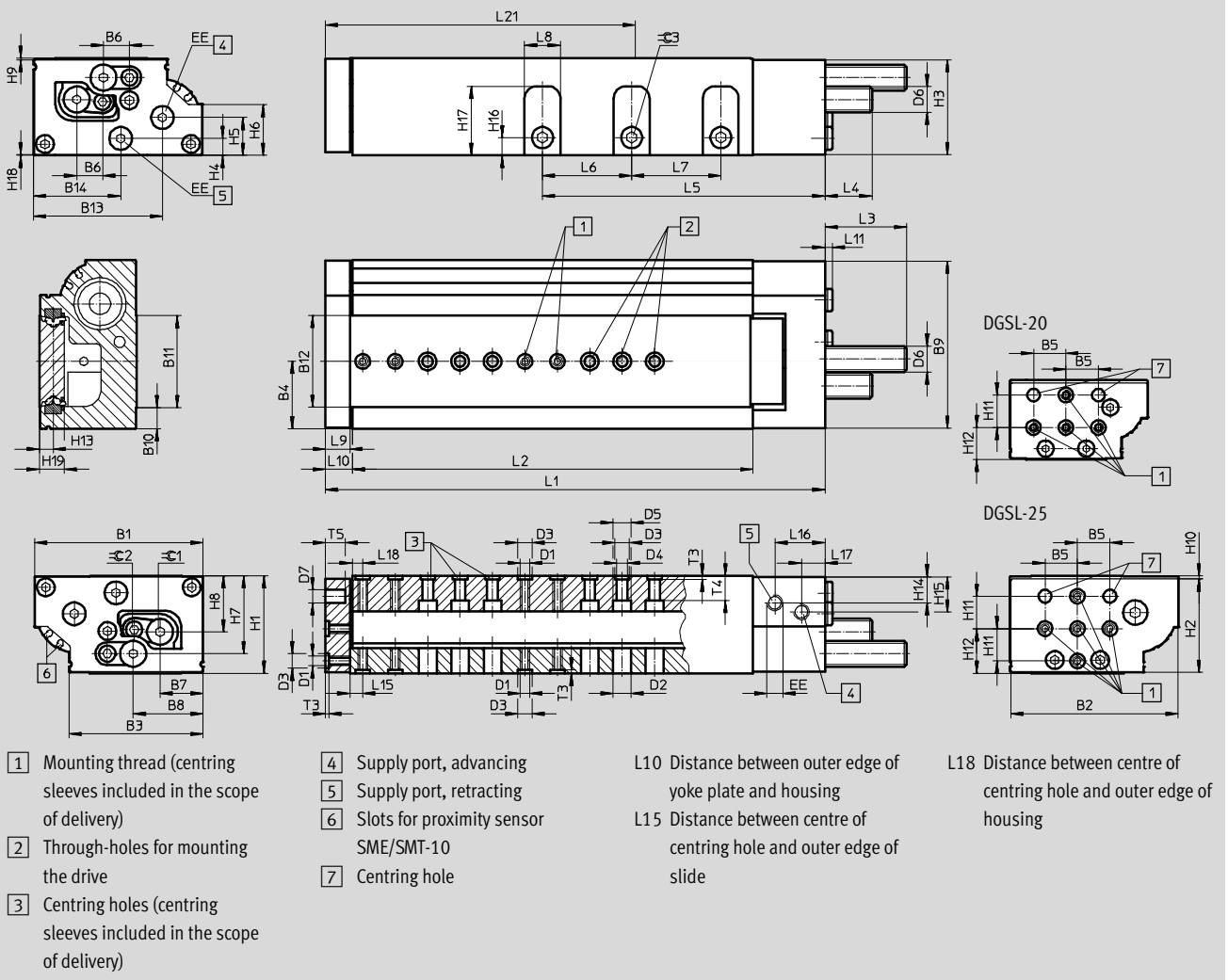

## General dimensions

Size	B1	B2	B3	B4	B5	B6	B7	B8	B9	B10	B11	B12	B13	B14	D1
20	85	84	68.85	34.5	20	14.15	21.4	36.35	83.4	10	48.9	49.2	64.1	48.6	M6
25	104	103	82.6	41.6	20	16.2	26.4	43.05	103	13.25	56.5	56.7	79.35	53.65	M6

Size	D2	D3	D4	D5	D6	D7	EE	H1	H2	H3	H4	H5	H6	H7	H8
	∅	∅	∅	∅		∅		±0.08							
20	11.2	9 <sup>H7</sup>	6.6	11	M14x1	8 <sup>H7</sup>	G <sup>1</sup> / <sub>8</sub>	49	46.5	47.7	10.3	20.6	23.2	38.2	26.1
25	11.2	9 <sup>H7</sup>	6.6	11	M16x1	8 <sup>H7</sup>	G <sup>1</sup> / <sub>8</sub>	60	57.5	58.5	10.45	23.35	31.15	47.95	34.5

Size	H9	H10	H11	H12	H13	H14	H15	H16	H17	H18	H19	T3	T4	T5	∠ 2	∠ 3
												+0.1				
20	0.5	2	20	19.6	7.55	14.7	14.7	10	33.3	0.8	14.6	2.1	8.6	10	4	5
25	1	2	20	27.5	8.55	16.55	21.15	11	42.7	0.45	15.6	2.1	15	12	5	6

# Mini slides DGSL

Technical data



Stroke-dependent dimensions															
Size	Stroke	L1	L2	L5	L6	L7	L8	L9	L10	L11	L15 ±0.05	L16	L17	L18 ±0.05	L21
20	10	141.2	84.6	59.1	-	-	17	14	15.6	4.6	7.8	30.5	12	6.5	56
	20	151.2	94.6	69.1											61
	30	161.2	104.6	79.1											66
	40	171.2	114.6	89.1											71
	50	183.2	126.6	99.1											76
	80	211.2	154.6	129.1											91
	100	270.2	213.6	149.1	44	44	121								
	150	333.2	276.6	199.1			152								
	200	383.2	326.6	249.1			177								
25	10	157.1	96	63.7	-	-	22	15	16.6	4.6	8	32.3	14.5	6.5	64
	20	167.1	106	72.2											69
	30	177.1	116	82.2											74
	40	187.1	126	92.2											79
	50	197.1	136	102.2											84
	80	253.1	192	132.2											55
	100	286.1	225	152.2	129										
	150	338.1	277	202.2	154										
	200	388.1	327	254.2	179										

Cushioning-dependent dimensions					
Size	Cushioning	L3 max.	L4 max.	≈ 1	
				For adjusting the cushioning stroke	For adjusting the end position
20	P	52.4	31.2	-	4
	E	8.8	0	-	4
	P1	50.1	28.9	4	8
	Y3	55.5	34.3	-	4
	Y11	67.4	45.9	-	4
25	P	51.9	30.5	-	5
	E	8.8	0	-	5
	P1	49.6	28.2	5	10
	Y3	65.2	43.8	-	5
	Y11	78.4	56.9	-	4

# Mini slides DGSL

Technical data

## Hole pattern for mounting threads and centring holes

DGSL-20-10/20

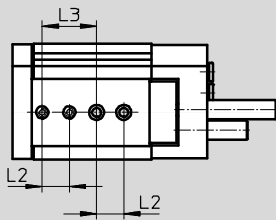

DGSL-20-30/40

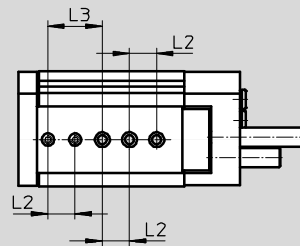

DGSL-20-50

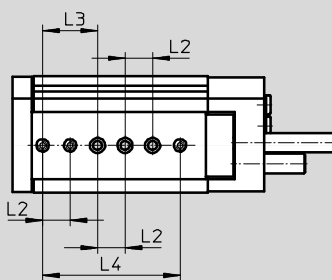

DGSL-20-80

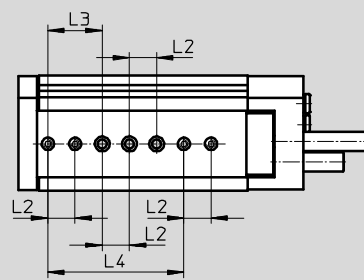

DGSL-20-100 ... 200

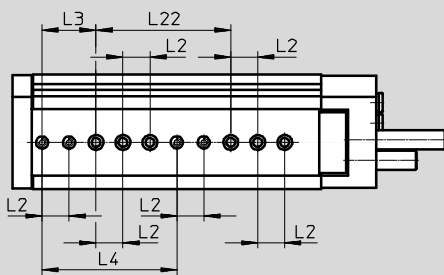

DGSL-25-10

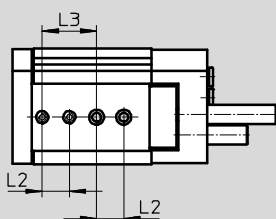

DGSL-25-20

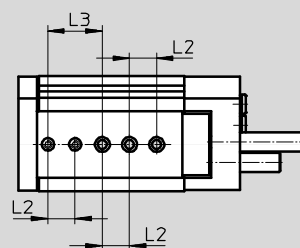

# Mini slides DGSL

Technical data

## Hole pattern for mounting threads and centring holes

DGSL-25-30/40

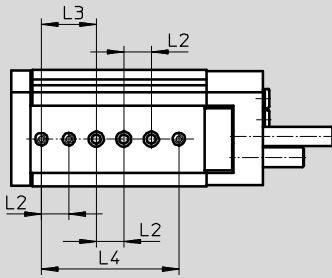

DGSL-25-50

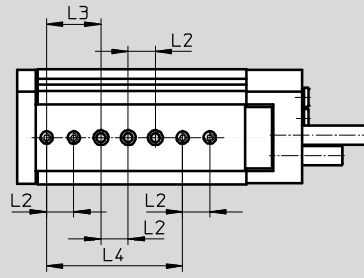

DGSL-25-80

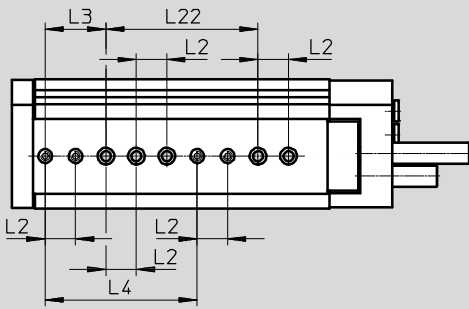

DGSL-25-100 ... 200

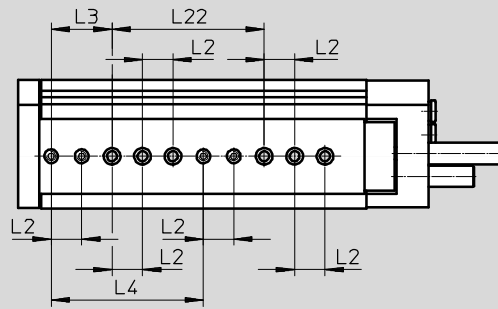

## Distances from yoke plate to mounting threads and centring holes

DGSL-20/25

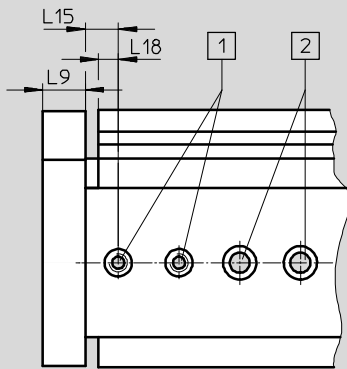

- 1 Centring holes with thread
- 2 Through-holes for mounting the drive

Size	L2 <sup>1)</sup>	L3 <sup>1)</sup>	L4	L9	L15 ±0.05	L18 ±0.05	L22
20	20	40	100 <sup>1)</sup>	14	7.8	6.5	100±0.03
25	20	40	100±0.03	15	8	6.5	100 <sup>1)</sup>

1) Tolerance for centring hole ±0.02  
Tolerance for through-hole ±0.1

# Mini slides DGSL-C/-E3

Technical data

FESTO

Function  
C – Clamping unit

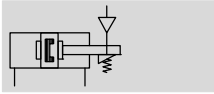

E3 – End-position locking

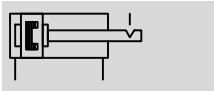

Size  
6 ... 25

Wearing parts kits  
→ 45



Note

Additional measures are required for use in safety-related applications; in Europe, for example, the standards listed under the EC Machinery Directive must be observed. Without

additional measures in accordance with statutory minimum requirements, the product is not suitable for use in safety-related sections of control systems.

General technical data – Clamping unit								
Size		6	8	10	12	16	20	25
Function		– Mechanical clamping – For fixing the slide in any position – Frictional locking						
Clamping type with operating direction		At both ends						
		Clamping via spring force, released via compressed air						
Pneumatic connection		M5						
Mounting position		Any						
Static holding force	[N]	80	80	180	180	350	350	600
Product weight	[g]	10	10	15	15	50	50	50

Operating and environmental conditions – Clamping unit	
Operating medium	Compressed air to ISO 8573-1:2010 [7:4:4]
Note on operating/pilot medium	Lubricated operation possible (in which case lubricated operation will always be required)
Min. release pressure	[bar] 3
Max. operating pressure	[bar] ≤ 10

General technical data – End-position locking								
Size		6	8	10	12	16	20	25
Function		– Mechanical locking when the end position is reached – For fixing the slide in the unpressurised, retracted state – Positive locking						
Clamping type with operating direction		At both ends						
		Clamping via spring force, unlocked via compressed air						
Pneumatic connection		M5						
Mounting position		Any						
Static holding force	[N]	60	60	160	160	250	380	640
Product weight	[g]	13	13	26	26	64	64	65

Operating and environmental conditions – End-position locking	
Operating medium	Compressed air to ISO 8573-1:2010 [7:4:4]
Note on operating/pilot medium	Lubricated operation possible (in which case lubricated operation will always be required)
Operating pressure	[bar] 3 ... 8



# Mini slides DGSL-C/-E3

Technical data

## Adjustable end-position range

When using end-position locking (E3), the adjustable range of the retracted end position is reduced by the following values.

1 Adjustable end-position range

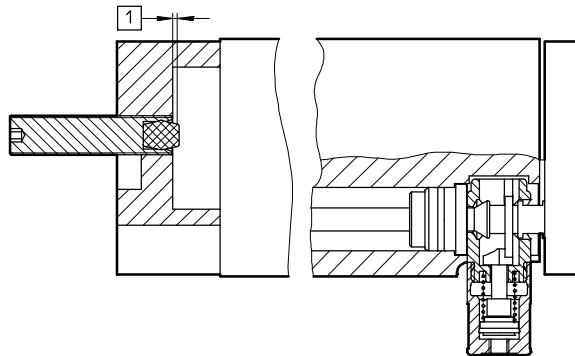

Size	1
6, 8	Max. 1.5 mm
10, 12	Max. 2.3 mm
16, 20, 25	Max. 2.7 mm

## Dimensions

Download CAD data → [www.festo.com](http://www.festo.com)

C – Clamping unit/E3 – End-position locking

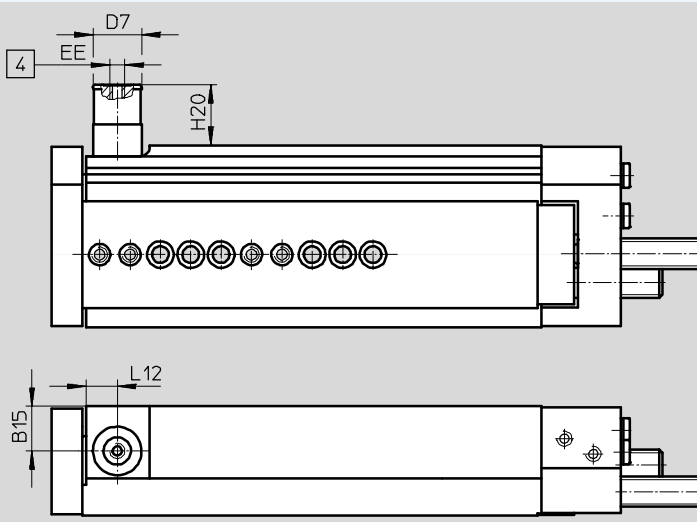

4 Supply port

Size	B15	D7 ∅	EE	H20		L12
				C	E3	
6	7.2	12	M5	10.7	21.2	7.3
8	9.9	12		10.5	21	7.3
10	11.2	16		11.8	21.2	10.5
12	14.8	16		10.5	19.9	10.3
16	14	20		27.5	30.5	13
20	17	20		21.3	24.3	14
25	22.55	20		17.75	20.65	14

# Mini slides DGSL



Technical data

Ordering data				Ordering data				
Size	Stroke [mm]	Part No.	Type	Size	Stroke [mm]	Part No.	Type	
With cushioning P				With cushioning E				
4	10	543910	DGSL-4-10-PA	4	10	570158	DGSL-4-10-EA	
	20	543911	DGSL-4-20-PA		20	570159	DGSL-4-20-EA	
	30	543912	DGSL-4-30-PA			30	570160	DGSL-4-30-EA
6	10	543916	DGSL-6-10-PA	6	10	570161	DGSL-6-10-EA	
	20	543917	DGSL-6-20-PA		20	570162	DGSL-6-20-EA	
	30	543918	DGSL-6-30-PA			30	570163	DGSL-6-30-EA
	40	543919	DGSL-6-40-PA		40		570164	DGSL-6-40-EA
	50	543920	DGSL-6-50-PA		50		570165	DGSL-6-50-EA
8	10	543926	DGSL-8-10-PA	8	10	570166	DGSL-8-10-EA	
	20	543927	DGSL-8-20-PA		20	570167	DGSL-8-20-EA	
	30	543928	DGSL-8-30-PA			30	570168	DGSL-8-30-EA
	40	543929	DGSL-8-40-PA		40		570169	DGSL-8-40-EA
	50	543930	DGSL-8-50-PA		50		570170	DGSL-8-50-EA
10	10	543931	DGSL-8-80-PA	10	80	570171	DGSL-8-80-EA	
	10	543942	DGSL-10-10-PA		10	10	570172	DGSL-10-10-EA
	20	543943	DGSL-10-20-PA			20	570173	DGSL-10-20-EA
	30	543944	DGSL-10-30-PA		30		570174	DGSL-10-30-EA
	40	543945	DGSL-10-40-PA			40	570175	DGSL-10-40-EA
50	543946	DGSL-10-50-PA	50	570176		DGSL-10-50-EA		
12	80	543947	DGSL-10-80-PA	12	80	570177	DGSL-10-80-EA	
	100	543948	DGSL-10-100-PA		100	570178	DGSL-10-100-EA	
	10	543961	DGSL-12-10-PA			10	570179	DGSL-12-10-EA
	20	543962	DGSL-12-20-PA		20		570180	DGSL-12-20-EA
	30	543963	DGSL-12-30-PA			30	570181	DGSL-12-30-EA
40	543964	DGSL-12-40-PA	40	570182	DGSL-12-40-EA			
50	543965	DGSL-12-50-PA	50	570183	DGSL-12-50-EA			
16	80	543966	DGSL-12-80-PA	16	80	570184	DGSL-12-80-EA	
	100	543967	DGSL-12-100-PA		100	570185	DGSL-12-100-EA	
	150	543968	DGSL-12-150-PA			150	570186	DGSL-12-150-EA
	10	543983	DGSL-16-10-PA		10		570187	DGSL-16-10-EA
	20	543984	DGSL-16-20-PA				20	570188
30	543985	DGSL-16-30-PA	30	570189	DGSL-16-30-EA			
40	543986	DGSL-16-40-PA		40	570190	DGSL-16-40-EA		
50	543987	DGSL-16-50-PA		50	570191	DGSL-16-50-EA		
20	80	543988	DGSL-16-80-PA	20	80	570192	DGSL-16-80-EA	
	100	543989	DGSL-16-100-PA		100	570193	DGSL-16-100-EA	
	150	543990	DGSL-16-150-PA			150	570194	DGSL-16-150-EA
	10	544005	DGSL-20-10-PA		10		570195	DGSL-20-10-EA
	20	544006	DGSL-20-20-PA				20	570196
30	544007	DGSL-20-30-PA	30	570197	DGSL-20-30-EA			
40	544008	DGSL-20-40-PA		40	570198	DGSL-20-40-EA		
50	544009	DGSL-20-50-PA		50	570199	DGSL-20-50-EA		
25	80	544010	DGSL-20-80-PA	25	80	570200	DGSL-20-80-EA	
	100	544011	DGSL-20-100-PA		100	570201	DGSL-20-100-EA	
	150	544012	DGSL-20-150-PA			150	570202	DGSL-20-150-EA
	200	544013	DGSL-20-200-PA		200		570203	DGSL-20-200-EA
	10	544030	DGSL-25-10-PA				10	570204
20	544031	DGSL-25-20-PA	20	570205	DGSL-25-20-EA			
30	544032	DGSL-25-30-PA		30	570206	DGSL-25-30-EA		
40	544033	DGSL-25-40-PA	40		570207	DGSL-25-40-EA		
50	544034	DGSL-25-50-PA	50		570208	DGSL-25-50-EA		
200	80	544035	DGSL-25-80-PA	200	80	570209	DGSL-25-80-EA	
	100	544036	DGSL-25-100-PA		100	570210	DGSL-25-100-EA	
	150	544037	DGSL-25-150-PA			150	570211	DGSL-25-150-EA
	200	544038	DGSL-25-200-PA		200		570212	DGSL-25-200-EA

# Mini slides DGSL

Technical data

FESTO

Ordering data				Ordering data								
Size	Stroke [mm]	Part No.	Type	Size	Stroke [mm]	Part No.	Type					
With cushioning P1				With cushioning Y3								
4	10	543913	DGSL-4-10-P1A	4	10	-						
	20	543914	DGSL-4-20-P1A		6	20	-					
	30	543915	DGSL-4-30-P1A			8	30	-				
6	10	543921	DGSL-6-10-P1A	6			10	-				
	20	543922	DGSL-6-20-P1A		8		20	-				
	30	543923	DGSL-6-30-P1A			10	30	-				
	40	543924	DGSL-6-40-P1A				10	40	-			
50	543925	DGSL-6-50-P1A	10	50				-				
8	10	543932		DGSL-8-10-P1A	8			10	-			
	20	543933		DGSL-8-20-P1A		10		20	-			
	30	543934		DGSL-8-30-P1A			10	30	543938	DGSL-8-30-Y3A		
	40	543935	DGSL-8-40-P1A	10				40	543939	DGSL-8-40-Y3A		
	50	543936	DGSL-8-50-P1A		10			50	543940	DGSL-8-50-Y3A		
80	543937	DGSL-8-80-P1A	10			80		543941	DGSL-8-80-Y3A			
10	10	543949				DGSL-10-10-P1A	10	10	-			
	20	543950		DGSL-10-20-P1A		10		20	-			
	30	543951		DGSL-10-30-P1A	10			30	543956	DGSL-10-30-Y3A		
	40	543952	DGSL-10-40-P1A	10				40	543957	DGSL-10-40-Y3A		
	50	543953	DGSL-10-50-P1A					10	50	543958	DGSL-10-50-Y3A	
	80	543954	DGSL-10-80-P1A						10	80	543959	DGSL-10-80-Y3A
100	543955	DGSL-10-100-P1A	10				100			543960	DGSL-10-100-Y3A	
12	10	543969				DGSL-12-10-P1A	12			10	-	
	20	543970			DGSL-12-20-P1A	12				20	-	
	30	543971		DGSL-12-30-P1A	12					30	543977	DGSL-12-30-Y3A
	40	543972		DGSL-12-40-P1A				12		40	543978	DGSL-12-40-Y3A
	50	543973		DGSL-12-50-P1A					12	50	543979	DGSL-12-50-Y3A
	80	543974	DGSL-12-80-P1A	12						80	543980	DGSL-12-80-Y3A
100	543975	DGSL-12-100-P1A	12				100			543981	DGSL-12-100-Y3A	
150	543976	DGSL-12-150-P1A				12	150			543982	DGSL-12-150-Y3A	
16	10	543991			DGSL-16-10-P1A		16			10	-	
	20	543992			DGSL-16-20-P1A			16		20	-	
	30	543993			DGSL-16-30-P1A				16	30	543999	DGSL-16-30-Y3A
	40	543994		DGSL-16-40-P1A	16					40	544000	DGSL-16-40-Y3A
	50	543995	DGSL-16-50-P1A	16						50	544001	DGSL-16-50-Y3A
	80	543996	DGSL-16-80-P1A			16				80	544002	DGSL-16-80-Y3A
100	543997	DGSL-16-100-P1A	16				100			544003	DGSL-16-100-Y3A	
150	543998	DGSL-16-150-P1A					16	150		544004	DGSL-16-150-Y3A	
20	10	544014						DGSL-20-10-P1A	20	10	-	
	20	544015			DGSL-20-20-P1A			20		20	-	
	30	544016		DGSL-20-30-P1A	20					30	544023	DGSL-20-30-Y3A
	40	544017		DGSL-20-40-P1A		20				40	544024	DGSL-20-40-Y3A
	50	544018	DGSL-20-50-P1A	20						50	544025	DGSL-20-50-Y3A
	80	544019	DGSL-20-80-P1A				20			80	544026	DGSL-20-80-Y3A
	100	544020	DGSL-20-100-P1A							20	100	544027
150	544021	DGSL-20-150-P1A	20						150		544028	DGSL-20-150-Y3A
200	544022	DGSL-20-200-P1A						20	200		544029	DGSL-20-200-Y3A
25	10	544039			DGSL-25-10-P1A				25		10	-
	20	544040			DGSL-25-20-P1A	25					20	-
	30	544041		DGSL-25-30-P1A	25						30	544048
	40	544042		DGSL-25-40-P1A			25				40	544049
	50	544043		DGSL-25-50-P1A						25	50	544050
	80	544044	DGSL-25-80-P1A	25							80	544051
	100	544045	DGSL-25-100-P1A					25			100	544052
150	544046	DGSL-25-150-P1A	25						150		544053	DGSL-25-150-Y3A
200	544047	DGSL-25-200-P1A				25			200		544054	DGSL-25-200-Y3A

Ordering data for modular products → 44

# Mini slides DGSL

Ordering data – Modular product



M Mandatory data				O Options		M	
Module No.	Function	Size	Stroke	Clamping unit	End-position locking	Cushioning	Position sensing
543902	DGSL	4	10 ... 200	C	E3	P	A
543903		6				P1	
543904		8				Y3	
543905		10				E	
543906		12				Y11	
543907		16				N	
543908		20					
543909		25					
<b>Ordering example</b>							
543904	DGSL	- 8	- 30	-	E3	- Y3	A

Ordering table												
Size	4	6	8	10	12	16	20	25	Condi- tions	Code	Enter code	
M Module No.	543902	543903	543904	543905	543906	543907	543908	543909				
Function	Mini slide with recirculating ball bearing guide									DGSL	DGSL	
Size	4	6	8	10	12	16	20	25	...			
Stroke [mm]	10									10		
	20									20		
	30									30		
	-	40								40		
	-	50								50		
	-	-	80							80		
	-	-	-	100						100		
	-	-	-	-	150					150		
	-	-	-	-	-	-	200			200		
O Clamping unit	-	Attached									C	
O End-position locking	-	With piston rod in retracted position							1		E3	
M Cushioning	Elastic cushioning rings/pads at both ends, end positions adjustable									P		
	Elastic cushioning rings/pads at both ends, end positions adjustable, with fixed stop									P1		
	Progressive shock absorber, at both ends									2	Y3	
	Elastic cushioning rings/pads at both ends, end positions adjustable, short design									E		
	Progressive shock absorber with reducing sleeve, at both ends									2	Y11	
	No cushioning									2	N	
M Position sensing	Via proximity sensor										A	

Note  
Operation without cushioning components is not permitted.

- 1 E3 Not with clamping unit C
- 2 Y3, Y11, N Minimum stroke 30 mm

**Transfer order code**

	DGSL	-		-		-		-		A
--	------	---	--	---	--	---	--	---	--	---

# Mini slides DGSL

Wearing parts kits and accessories



Ordering data – Wearing parts kits			Ordering data – Wearing parts kits		
Size	Part No.	Type	Size	Part No.	Type
4	713743	DGSL-4-...	12	713747	DGSL-12-...
6	713744	DGSL-6-...	16	713748	DGSL-16-...
8	713745	DGSL-8-...	20	713749	DGSL-20-...
10	713746	DGSL-10-...	25	713750	DGSL-25-...

## Cover DADS

Material:  
Anodised aluminum  
Free of copper, PTFE and silicone  
RoHS-compliant

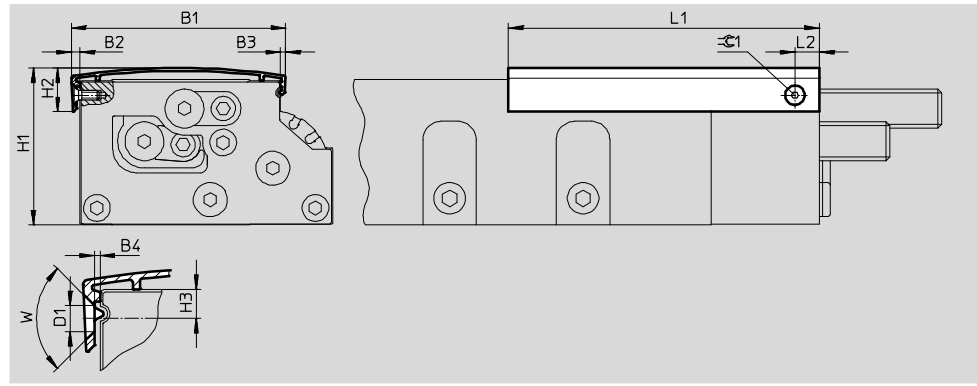

Dimensions and ordering data																
For size	Length [mm]	B1	B2	B3	B4	D1	H1	H2	H3	L1	L2	W	$\varnothing C1$	Weight [g]	Part No.	Type
4	30	22	1.9	-	0.4	2.8	17.9	7.5	2	40	4.5	90°	-	2	1086663	DADS-AB-G6-4-30
	500									27				1212468	DADS-AB-G6-4-500	
6	50	31.2	1.4	-	0	2.8	22	8.2	2.5	63	6	90°	-	4	1066625	DADS-AB-G6-6-50
	500									33				1212476	DADS-AB-G6-6-500	
8	80	36.3	1.9	-	0.3	2.8	26.5	8.2	2	93	7	90°	-	8	1087413	DADS-AB-G6-8-80
	500									42				1212478	DADS-AB-G6-8-500	
10	50	43.6	2.8	2.2	1.2	3.4	32	12	3.4	70	10	90°	2	11	1162400	DADS-AB-G6-10-50
	100									18				1090689	DADS-AB-G6-10-100	
	500									75				1212479	DADS-AB-G6-10-500	
12	50	51.7	2.7	2	0.5	3.4	38.8	12.8	4.25	72	10	90°	2	12	1162406	DADS-AB-G6-12-50
	150									28				1090732	DADS-AB-G6-12-150	
	500									82				1212480	DADS-AB-G6-12-500	
16	50	60	4.3	3.1	2.25	3.4	43.7	15.2	5	73	10	90°	2	21	1162410	DADS-AB-G6-16-50
	150									49				1066591	DADS-AB-G6-16-150	
	500									141				1212503	DADS-AB-G6-16-500	
20	50	74.8	3.6	2.8	1.2	4.4	53.2	18.9	6.5	74	10	90°	2.5	28	1162412	DADS-AB-G6-20-50
	100									46				1162415	DADS-AB-G6-20-100	
	200									83				1090823	DADS-AB-G6-20-200	
	500									184				1212521	DADS-AB-G6-20-500	
25	50	88.4	3.5	2.7	0.7	4.4	64.7	18.3	6	78	10	90°	2.5	34	1162417	DADS-AB-G6-25-50
	100									55				1162419	DADS-AB-G6-25-100	
	200									98				1090895	DADS-AB-G6-25-200	
	500									213				1212523	DADS-AB-G6-25-500	

- - Note  
With the 500 mm covers, the mounting hole must be made by the customer. The cover can be trimmed as required by the customer.

# Mini slides DGSL

Accessories



## Intermediate position module DADM



The intermediate position module enables an additional adjustable position within the stroke range. The module is attached separately, directly next to the mini slide. It can be mounted anywhere along the mini slide. The associated shock absorber retainer → 48 can be attached at several points on the slide. The position can be precisely adjusted

using the shock absorber. The stop lever positions can be sensed via proximity sensor SME/SMT-10 → 51.

Material:  
Housing: Wrought aluminium alloy  
Lever: High-alloy stainless steel  
RoHS-compliant

### Dimensions and ordering data

Technical data → Internet: dadm

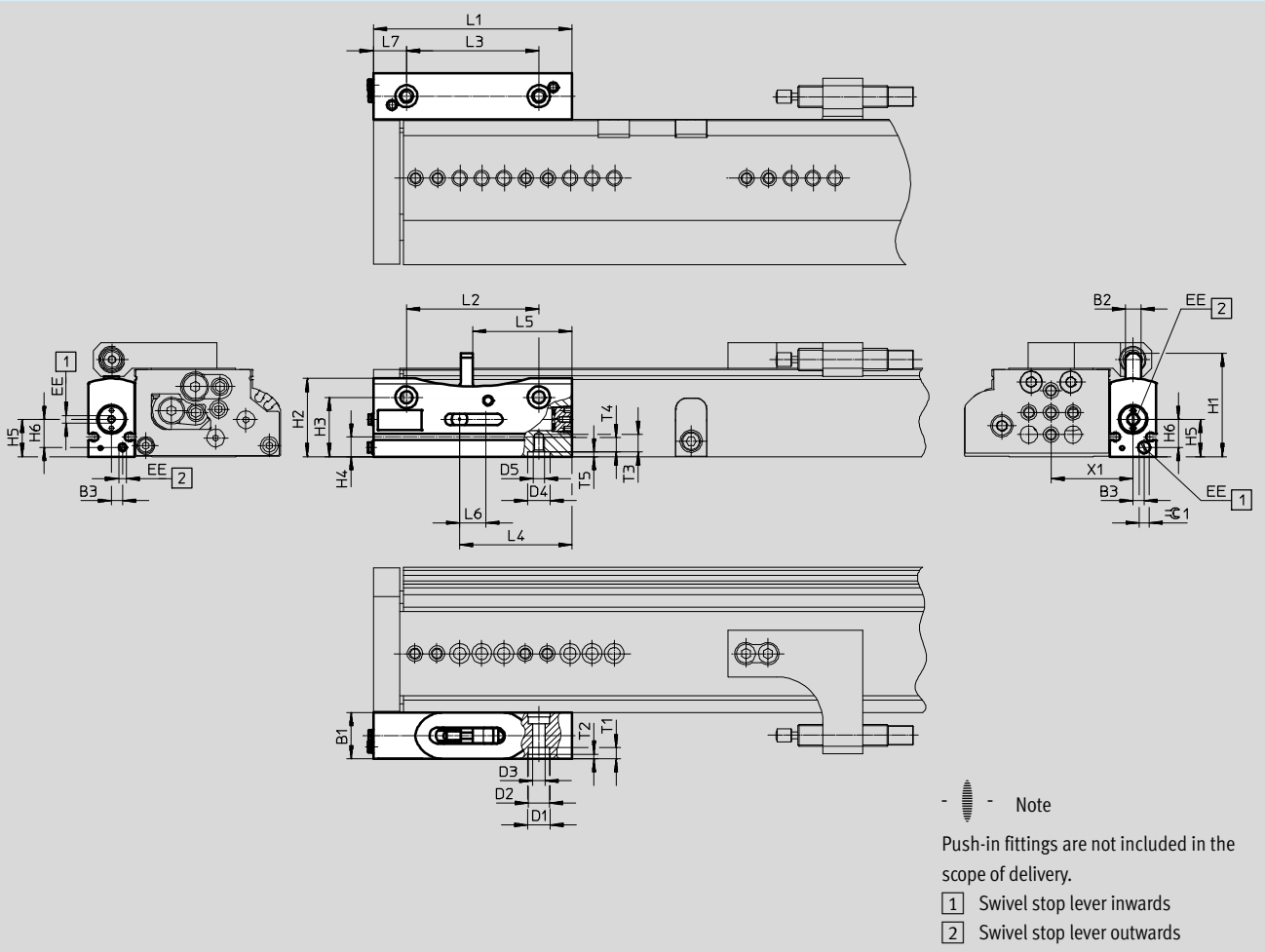

For size	B1	B2	B3	D1	D2	D3	D4	D5	EE	H1	H2
			±0.1	∅ H7	∅	∅	∅ H7				
12, 16	21	7	5	10	9.5	5.5	10	M5	M3	46.9	35.4
20, 25	26.5	9	5.5	12	11	6.6	12	M6	M5	65.2	47.4



# Mini slides DGSL

Accessories

FESTO

For size	H3	H4	H5	H6	L1	L2	L3	L4	L5	L6	L7
	±0.1		±0.1	±0.1		±0.1	±0.1				
12, 16	26.9	8.9	16.9	12.7	90	60	60	51	45	12	15
20, 25	36.4	12.4	23.4	17	120	80	80	68	52.5	16	20

For size	T1	T2	T3	T4	T5	X1	⌀C1	Weight [g]	Part No.	Type
		+0.2			+0.1	+0.2				
12	5	2.1	8	6.5	2.1	35.1	4.5	154	1492072	DADM-EP-G6-10
16										
20	6.8	2.1	10	8	2.1	48.2	2.5	340	1478121	DADM-EP-G6-16
25										

Ordering data					
	For size	Description	Part No.	Type	PU <sup>1)</sup>
Connector sleeve ZBV <span style="float: right;">Technical data → Internet: zbv</span>					
	12, 16	For centring the intermediate position module (2 pieces included in scope of delivery for the intermediate position module)	560254	ZBV-10-9	10
Centring sleeve ZBH <span style="float: right;">Technical data → Internet: zbh</span>					
	20, 25	For centring the intermediate position module (2 pieces included in scope of delivery for the intermediate position module)	189653	ZBH-12	10

1) Packaging unit quantity

## Mounting

The intermediate position module is mounted directly next to the mini slide and is fastened to the mounting surface using two screws and centring sleeves.

The shock absorber retainer is then mounted on the slide of the mini slide, also using two screws and centring sleeves.

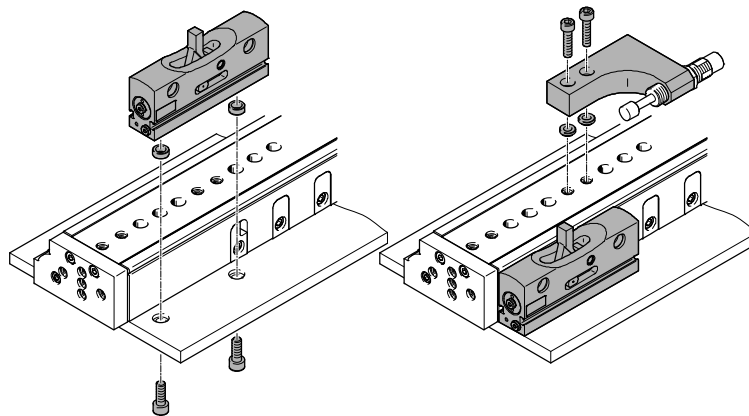

Precision adjustment:

The position can be precisely adjusted via the screw-in depth of the shock absorber. The shock absorber must project by at least  $X = 1.5$  mm.

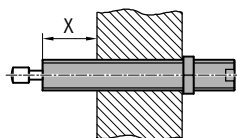

# Mini slides DGSL

Accessories

FESTO

## Shock absorber retainer DADP

Material:  
Anodised wrought aluminium alloy  
RoHS-compliant

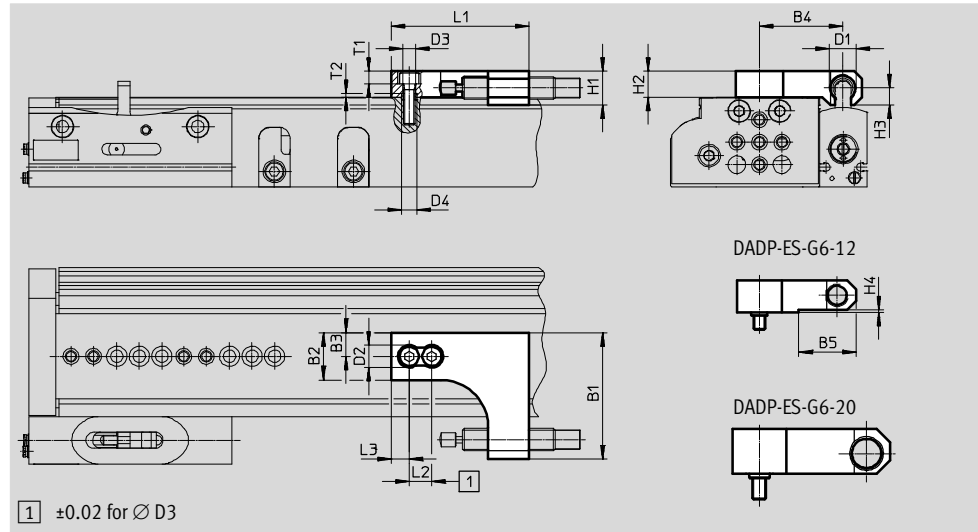

### Dimensions and ordering data

For size	B1	B2	B3	B4	B5	D1	D2 Ø	D3 Ø	D4 Ø H7	H1	H2
12	53	20	10	34.5	25.5	M10x1	10	5.5	7	13	14
16	56	21	10.5	37	39.2	M12x1	10	5.5	7	15	12.2
20	70	24	12	47.5	-	M14x1	11	6.6	12	20	20
25	80	30	15	54.5	58	M16x1	11	6.6	12	25	14

For size	H3	H4	L1	L2	L3	T1	T2	Weight [g]	Part No.	Type
12	6.5	1	65	10	10	5.7	1.6	80	1812471	DADP-ES-G6-12
16	7.5	2.8	61	10	8	5.7	1.6	70	1812472	DADP-ES-G6-16
20	9	-	85	20	10	6.4	2.6	185	1812473	DADP-ES-G6-20
25	10	11	80	20	10	6.8	2.6	160	1812550	DADP-ES-G6-25

### Note





- A shock absorber retainer DADP-ES is additionally required when using an intermediate position module
- Operation without cushioning components is not permitted
- Cushioning components are not included in the scope of delivery
- The shock absorbers for mini slides and for the associated shock absorber retainer are of identical size. Shock absorber selection → 49
- The same cushioning component as is used in the end positions of the mini slide is used for cushioning the intermediate position



# Mini slides DGSL

Accessories

**FESTO**



Ordering data							
	For size	For shock absorber retainer	Description	Order code	Part No.	Type	PU <sup>1)</sup>
Shock absorber DYEF-...-Y1 <span style="float: right;">Technical data → Internet: dyef</span>							
	4	–	Flexible cushioning, without metal stop	P	1179810	DYEF-M4-Y1	1
	6	–			1179818	DYEF-M5-Y1	
	8	–			1179831	DYEF-M6-Y1	
	10	–			1179834	DYEF-M8-Y1	
	12	DADP-ES-G6-12			1179837	DYEF-M10-Y1	
	16	DADP-ES-G6-16			1179840	DYEF-M12-Y1	
	20	DADP-ES-G6-20			1179863	DYEF-M14-Y1	
	25	DADP-ES-G6-25			1179879	DYEF-M16-Y1	
Shock absorber DYEF-S-...-Y1 <span style="float: right;">Technical data → Internet: dyef</span>							
	4	–	Flexible cushioning, without metal stop, short version	E	1152500	DYEF-S-M4-Y1	1
	6	–			1152507	DYEF-S-M5-Y1	
	8	–			1152524	DYEF-S-M6-Y1	
	10	–			1152536	DYEF-S-M8-Y1	
	12	DADP-ES-G6-12			1152959	DYEF-S-M10-Y1	
	16	DADP-ES-G6-16			1153004	DYEF-S-M12-Y1	
	20	DADP-ES-G6-20			1153017	DYEF-S-M14-Y1	
	25	DADP-ES-G6-25			1153023	DYEF-S-M16-Y1	
Shock absorber DYEF-...-Y1F <span style="float: right;">Technical data → Internet: dyef</span>							
	4	–	Flexible cushioning, with metal stop	P1	548370	DYEF-M4-Y1F	1
	6	–			548371	DYEF-M5-Y1F	
	8	–			548372	DYEF-M6-Y1F	
	10	–			548373	DYEF-M8-Y1F	
	12	DADP-ES-G6-12			548374	DYEF-M10-Y1F	
	16	DADP-ES-G6-16			548375	DYEF-M12-Y1F	
	20	DADP-ES-G6-20			548376	DYEF-M14-Y1F	
	25	DADP-ES-G6-25			548377	DYEF-M16-Y1F	
Shock absorber DYSW <span style="float: right;">Technical data → Internet: dysw</span>							
	8	–	Progressive shock absorbers, both ends	Y3	548070	DYSW-4-6-Y1F	1
	10	–			548071	DYSW-5-8-Y1F	
	12	DADP-ES-G6-12			548072	DYSW-7-10-Y1F	
	16	DADP-ES-G6-16			548073	DYSW-8-14-Y1F	
	20	DADP-ES-G6-20			548074	DYSW-10-17-Y1F	
	25	DADP-ES-G6-25			548075	DYSW-12-20-Y1F	
Reducing sleeve DAYH							
	10	–	For DYSW-4-6	–	1165476	DAYH-4	1
	12	DADP-ES-G6-12	For DYSW-5-8		1165480	DAYH-5	
	16	DADP-ES-G6-16	For DYSW-7-10		1165484	DAYH-7	
	20	DADP-ES-G6-20	For DYSW-8-14		1165488	DAYH-8	
	25	DADP-ES-G6-25	For DYSW-10-17		1165491	DAYH-10	

1) Packaging unit quantity



# Mini slides DGSL

Accessories

FESTO

Ordering data					
	For size	Brief description	Part No.	Type	PU <sup>1)</sup>
Centring sleeve ZBH <span style="float: right;">Technical data → Internet: zbh</span>					
	4, 6	For centring loads and attachments (6 centring sleeves are included in the scope of delivery of the mini slide)	<b>189652</b>	<b>ZBH-5</b>	10
	8, 10, 12, 16		<b>186717</b>	<b>ZBH-7</b>	
	20, 25		<b>150927</b>	<b>ZBH-9</b>	
Connector sleeve ZBV <span style="float: right;">Technical data → Internet: zbv</span>					
	8, 10	<ul style="list-style-type: none"> <li>For connecting two mini slides DGSL</li> <li>Sizing information refers to the Y-axis</li> </ul>	<b>548802</b>	<b>ZBV-M4-7</b>	3
	12, 16		<b>548803</b>	<b>ZBV-M5-7</b>	
	20, 25		<b>548804</b>	<b>ZBV-M6-9</b>	

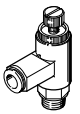
1) Packaging unit

Ordering data					
	For size	Brief description	Part No.	Type	PU <sup>1)</sup>
One-way flow control valve GRLA <span style="float: right;">Technical data → Internet: grla</span>					
	4, 6, 8	<ul style="list-style-type: none"> <li>For regulating speed</li> <li>Only one GRLA-M3-QS-3 can be mounted on the front with size 4</li> </ul>	<b>175041</b>	<b>GRLA-M3-QS-3</b>	1
	10, 12, 16		<b>175038</b>	<b>GRLA-M3</b>	
			<b>193137</b>	<b>GRLA-M5-QS-3-D</b>	
			<b>193138</b>	<b>GRLA-M5-QS-4-D</b>	
	20, 25		<b>193143</b>	<b>GRLA-1/8-QS-4-D</b>	
	20, 25	<b>193144</b>	<b>GRLA-1/8-QS-6-D</b>		
		<b>162965</b>	<b>GRLA-1/8-QS-6-RS-B</b>		
		<b>162966</b>	<b>GRLA-1/8-QS-8-RS-B</b>		
Push-in fitting QSM <span style="float: right;">Technical data → Internet: quick star</span>					
	4, 6, 8	For connecting compressed air tubing with standard O.D.	<b>153301</b>	<b>QSM-M3-3</b>	10
	10, 12, 16		<b>153304</b>	<b>QSM-M5-4</b>	
	20, 25		<b>153307</b>	<b>QSM-1/8-6</b>	

1) Packaging unit

# Mini slides DGSL

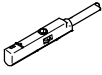

Accessories

FESTO

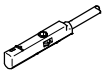
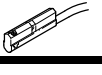
Ordering data – Proximity sensor for C-slot, magneto-resistive						Technical data → Internet: smt	
	Type of mounting	Switching output	Electrical connection, connection direction	Cable length [m]	Part No.	Type	
N/O contact							
	Insertable in the slot from above	PNP	Cable, 3-wire, in-line	2.5	551373	SMT-10M-PS-24V-E-2,5-L-OE	
			Plug M8x1, 3-pin, in-line	0.3	551375	SMT-10M-PS-24V-E-0,3-L-M8D	
			Plug M8x1, 3-pin, angled	0.3	551376	SMT-10M-PS-24V-E-0,3-Q-M8D	

Ordering data – Proximity sensor for C-slot, magnetic reed						Technical data → Internet: sme	
	Type of mounting	Switching output	Electrical connection, connection direction	Cable length [m]	Part No.	Type	
N/O contact							
	Insertable in the slot from above	Contacting	Plug M8x1, 3-pin, in-line	0.3	551367	SME-10M-DS-24V-E-0,3-L-M8D	
			Cable, 3-wire, in-line	2.5	551365	SME-10M-DS-24V-E-2,5-L-OE	
			Cable, 2-wire, in-line	2.5	551369	SME-10M-ZS-24V-E-2,5-L-OE	
	Insertable in the slot lengthwise	Contacting	Plug M8x1, 3-pin, in-line	0.3	173212	SME-10-SL-LED-24	
			Cable, 3-wire, in-line	2.5	173210	SME-10-KL-LED-24	

 Note  
Proximity sensors SME are not permitted with size 4.

Ordering data – Connecting cables					Technical data → Internet: nebu	
	Electrical connection, left	Electrical connection, right	Cable length [m]	Part No.	Type	
	Straight socket, M8x1, 3-pin	Cable, open end, 3-wire	2.5	541333	NEBU-M8G3-K-2.5-LE3	
			5	541334	NEBU-M8G3-K-5-LE3	
	Angled socket, M8x1, 3-pin	Cable, open end, 3-wire	2.5	541338	NEBU-M8W3-K-2.5-LE3	
			5	541341	NEBU-M8W3-K-5-LE3	

# Mini slides DGSL

Accessories

FESTO

Adapter kit  
HMSV

Material:  
Wrought aluminium alloy  
Free of copper and PTFE  
RoHS-compliant

 Note  
The kit includes the individual mounting interface as well as the necessary mounting material.

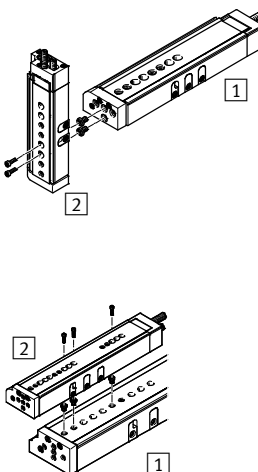
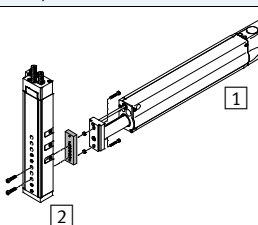
Permissible drive/drive combinations with adapter kit							Download CAD data → <a href="http://www.festo.com">www.festo.com</a>	
Combination	1	2	Adapter kit					
	Drive Size	Drive Size	CRC <sup>1)</sup>	Part No.	Type	Quantity required	PU <sup>2)</sup>	
DGSL/DGSL	DGSL	DGSL						
	4	4	2	–	M3x7 DIN 912 <sup>3)</sup>	2	–	
				189652	ZBH-5 <sup>4)</sup>	2	10	
	6	4, 6		–	M3x10 DIN 912 <sup>3)</sup>	2	–	
				189652	ZBH-5 <sup>4)</sup>	2	10	
	8, 10	4, 6		548802	ZBV-M4-7	1	3	
	8, 10	8		–	M4x12 DIN 912 <sup>3)</sup>	2	–	
				186717	ZBH-7 <sup>4)</sup>	2	10	
	10	10		–	M4x14 DIN 912 <sup>3)</sup>	2	–	
				186717	ZBH-7 <sup>4)</sup>	2	10	
	12, 16	8, 10		548803	ZBV-M5-7	1	3	
	12	12		–	M5x14 DIN 912 <sup>3)</sup>	2	–	
				186717	ZBH-7 <sup>4)</sup>	2	10	
	16	12		–	M5x16 DIN 912 <sup>3)</sup>	2	–	
				186717	ZBH-7 <sup>4)</sup>	2	10	
16	16	–	M5x18 DIN 912 <sup>3)</sup>	2	–			
		186717	ZBH-7 <sup>4)</sup>	2	10			
20, 25	12, 16	548804	ZBV-M6-9	1	3			
20, 25	20	–	M6x20 DIN 912 <sup>3)</sup>	2	–			
		150927	ZBH-9 <sup>4)</sup>	2	10			
25	25	–	M6x30 DIN 912 <sup>3)</sup>	2	–			
		150927	ZBH-9 <sup>4)</sup>	2	10			
HMP/DGSL	HMP	DGSL	HMSV					
	16	16	2	548779	HMSV-49	1	1	
	20	16, 20						
	25	20, 25						
	32	25						

- 1) Corrosion resistance class CRC 2 to Festo standard FN 940070  
Moderate corrosion stress. Indoor applications in which condensation may occur. External visible parts with primarily decorative requirements for the surface and which are in direct contact with the ambient atmosphere typical for industrial applications.
- 2) Packaging unit quantity
- 3) The screws listed are not included in the scope of delivery of the drives
- 4) The centring sleeves are included in the scope of delivery of the drives

# Mini slides DGSL

Accessories



**Adapter kit**  
HAPS, HMSV

Material:  
Wrought aluminium alloy  
Free of copper and PTFE  
RoHS-compliant

 Note  
The kit includes the individual mounting interface as well as the necessary mounting material.

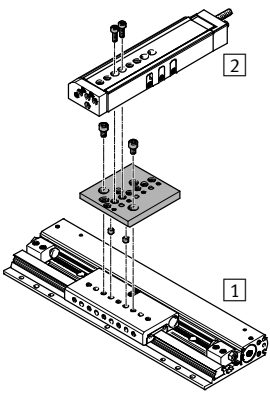
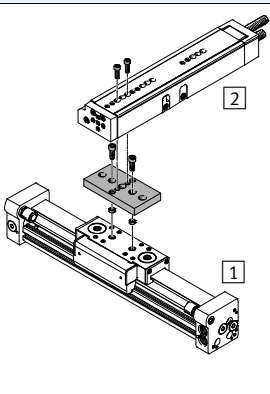
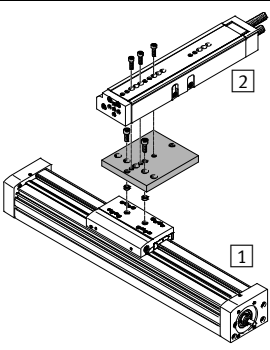
Permissible drive/drive combinations with adapter kit				Download CAD data → <a href="http://www.festo.com">www.festo.com</a>			
Combination	1	2	Adapter kit				
	Drive	Drive	CRC <sup>1)</sup>	Part No.	Type	Quantity required	PU <sup>2)</sup>
	SLG	DGSL	HAPS				
	8, 12	4, 6	2	189533	HAPS-11	1	1
	12	8, 10		189534	HAPS-12	1	1
	18	8, 10, 12					
	DGC	DGSL	HMSV				
	8, 12	4, 6	2	548777	HMSV-47	1	1
	18	8, 10		548778	HMSV-48	1	1
	18	12, 16		189657	HMSV-41	1	1
	25	12, 16, 20, 25		548781	HMSV-51	1	1
	32, 40	20, 25		548780	HMSV-50	1	1
	DGE-...	DGSL	HMSV				
	25	12, 16, 20, 25	2	548781	HMSV-51	1	1
	40	20, 25		548780	HMSV-50	1	1

1) Corrosion resistance class CRC 2 to Festo standard FN 940070  
Moderate corrosion stress. Indoor applications in which condensation may occur. External visible parts with primarily decorative requirements for the surface and which are in direct contact with the ambient atmosphere typical for industrial applications.

# Mini slides DGSL

Accessories



**Adapter kit  
HMSV**

Material:  
Wrought aluminium alloy  
Free of copper and PTFE  
RoHS-compliant

 Note  
The kit includes the individual mounting interface as well as the necessary mounting material.

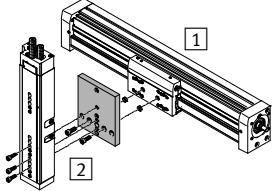
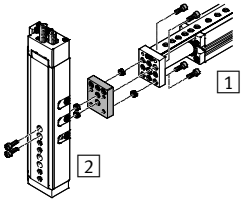
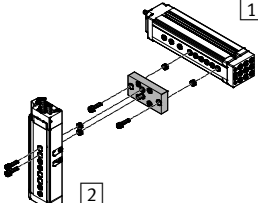
Permissible drive/drive combinations with adapter kit							Download CAD data → <a href="http://www.festo.com">www.festo.com</a>	
Combination	1	2	Adapter kit			Quantity required	PU <sup>2)</sup>	
	Drive	Drive	CRC <sup>1)</sup>	Part No.	Type			
EGC/DGSL	EGC	DGSL	HMSV					
	50	4, 6	2	548777	HMSV-47	1	1	
	70	8, 10		548778	HMSV-48	1	1	
	70	12, 16		189657	HMSV-41	1	1	
	80	12, 16, 20, 25		548781	HMSV-51	1	1	
	120	20, 25		548780	HMSV-50	1	1	
EGSL/DGSL	EGSL	DGSL	HMSV					
	35	4, 6, 8, 10	2	1088262	HMSV-70	1	–	
	45, 55	8, 10		548803	ZBV-M5-7	1	3	
	45	12, 16		–	M5x14 DIN 912 <sup>3)</sup>	2	–	
				186717	ZBH-7 <sup>4)</sup>	2	10	
	55	12, 16		–	M5x12 DIN 912 <sup>3)</sup>	2	–	
				186717	ZBH-7 <sup>4)</sup>	2	10	
	75	12, 16		548804	ZBV-M6-9	1	3	
75	20	–	M6x20 DIN 912 <sup>3)</sup>	2	–			
		150927	ZBH-9 <sup>4)</sup>	2	10			
	35	4, 6, 8, 10	2	1088327	HMSV-73	1	–	

- 1) Corrosion resistance class CRC 2 to Festo standard FN 940070  
Moderate corrosion stress. Indoor applications in which condensation may occur. External visible parts with primarily decorative requirements for the surface and which are in direct contact with the ambient atmosphere typical for industrial applications.
- 2) Packaging unit quantity
- 3) The screws listed are not included in the scope of delivery of the drives
- 4) The centring sleeves are included in the scope of delivery of the drives