

Guided drives DGRF-C, Clean Design

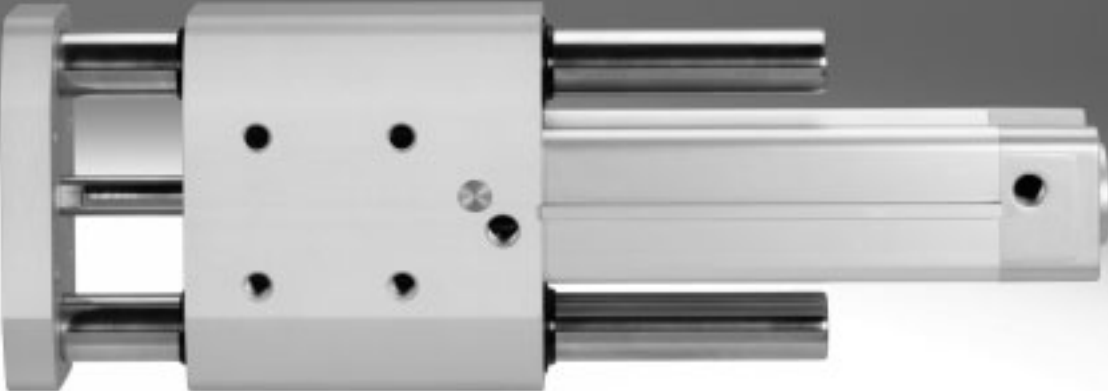

Guided drives DGRF-C, Clean Design

Features and Product range overview



At a glance

- The guided drive is used wherever hygiene, ease of cleaning and resistance are important, predominantly in dry and splash zones in the food and packaging industry.
- Corrosion-resistant in harsh environmental conditions
- Easy-to-clean design
- NSF-H1 compliant lubrication
- Resistant to conventional cleaning agents
- For hygiene reasons, the threads on the end caps should be sealed with suitable blanking screws
- With a dry-running seal (A3), the cylinder will continue to function reliably even if the lubricant has been washed away due to frequent cleaning.

Areas of application:

- Bottling systems in the beverage industry
 - Labelling and palletising machines
- Milk processing
 - Filling ice cream and yoghurt containers, etc.
- Meat processing
- Confectionery production
- Bakery production
- Packaging industry
 - Food, pharmaceuticals, cosmetics, chemicals, beverages and tobacco

Mounting options

Underneath

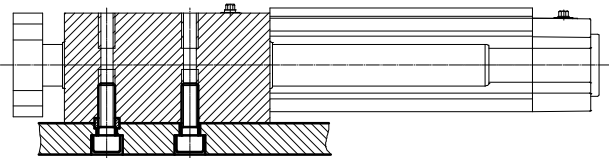

On top

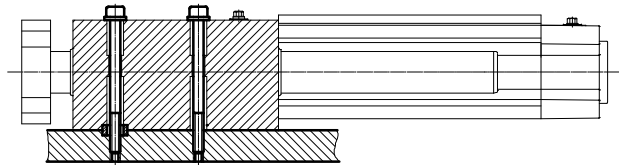

On the yoke plate

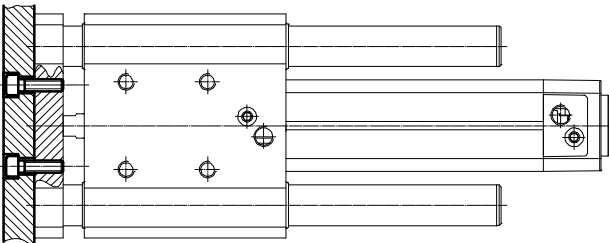

Product range overview

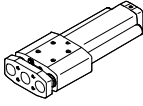
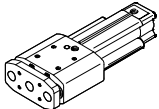
Function	Type	Piston Ø	Stroke	Cushioning			Position sensing	Mounting rail	Unlubricated operation
				P	PPV	PPS			
Double-acting	DGRF-C-GF								
		20, 25	10 ... 400	■	–	–	–	–	■
		32	10 ... 400	■	■	■	■	■	■
		40, 50, 63	10 ... 400	–	■	■	■	■	■

Guided drives DGRF-C, Clean Design

Peripherals overview

Piston \varnothing 20, 25

Piston \varnothing 32, 40, 50, 63

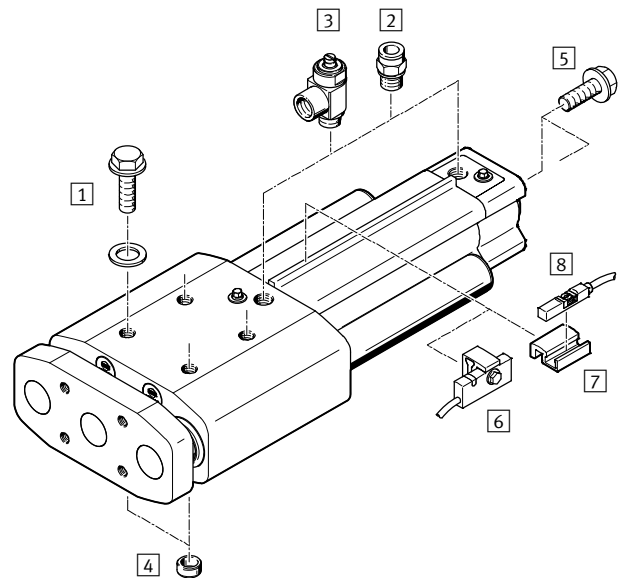
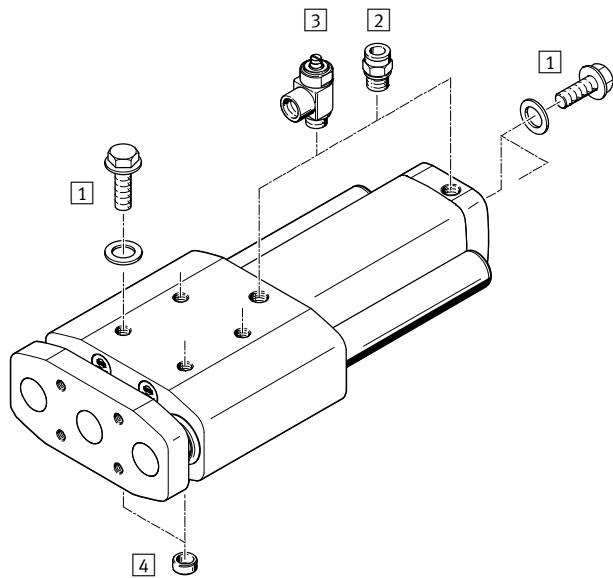

Accessories	Brief description	DGRF-...-			→ Page/ Internet
		P	PPV	PPS	
1 Plug screw DAMD	<ul style="list-style-type: none"> For sealing unused mounting threads The cover plate is included with the screw The screws are not included with the drive 	■	■	■	15
2 Push-in fitting NPQH/CRQS/CRQSL/NPQP	For connecting overall toleranced tubing	■	■	■	13
3 One-way flow control valve CRGRLA/GRLA-F	For regulating speed	■	■	■	14
4 Centring sleeve ZBH	<ul style="list-style-type: none"> For centring the guided drive Two centring sleeves are included in the scope of delivery 	■	■	■	15
5 Plug screw DAMD	<ul style="list-style-type: none"> For sealing unused mounting threads The screws are not included with the drive 	■	■	■	15
6 Proximity sensor SMT-C1	<ul style="list-style-type: none"> For sensing the piston rod position Proximity sensor is mounted on the sensor mounting rail 	■	■	■	12
7 Mounting kit SMB-8-C	<ul style="list-style-type: none"> For mounting the proximity sensor CRSMT-8M Mounting kit is mounted on the sensor mounting rail 	-	■1)	■	12
8 Proximity sensor CRSMT-8M	For sensing the piston rod position	-	■1)	■	12

1) Possible when ordering cylinders from 02/2014 (series E2).

Guided drives DGRF-C, Clean Design

Type codes

DGRF - C - GF - 32 - 200 - PPV - A - R - A3

Type	
Double-acting	
DGRF	Guided drive
Design	
C	Easy-to-clean design
Guide	
GF	Plain-bearing guide
Piston Ø [mm]	
Stroke [mm]	
Cushioning	
P	Elastic cushioning rings at both ends
PPV	Pneumatic cushioning, adjustable at both ends
PPS	Pneumatic cushioning, self-adjusting at both ends
Position sensing	
A	Via proximity sensor
Sensor mounting, external	
R	Mounting rail for proximity sensor
Wiper seal material	
-	Standard
A3	Suitable for unlubricated operation

Guided drives DGRF-C, Clean Design

Technical data

Function

P cushioning

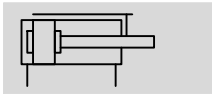

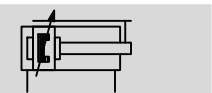

PPV cushioning

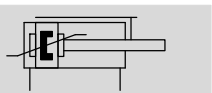

PPS cushioning



-  Diameter
20 ... 63 mm
-  Stroke length
10 ... 400 mm
-  www.festo.com



General technical data						
Piston \varnothing	20	25	32	40	50	63
Pneumatic connection	M5	M5	G $\frac{1}{8}$	G $\frac{1}{4}$	G $\frac{1}{4}$	G $\frac{3}{8}$
Mode of operation	Double-acting					
Design	Guide					
	Guide rods with yoke					
Guide	Plain-bearing guide					
Cushioning	P	Elastic cushioning rings at both ends			-	
	PPV	-			Pneumatic cushioning, adjustable at both ends	
	PPS	-			Pneumatic cushioning, self-adjusting at both ends	
Cushioning length	[mm]	-	20	20	22	22
Position sensing		-	Via proximity sensor			
Type of mounting	Via through-hole					
	Via female thread					
Mounting position	Any					
Torsional backlash ¹⁾	[°]	0.13	0.11	0.10	0.09	0.07

1) Retracted state, without load

Operating and environmental conditions						
Piston \varnothing	20	25	32	40	50	63
Variant			P	PPV/PPS		
Operating medium	Compressed air to ISO 8573-1:2010 [7:4:4]					
Note on operating/pilot medium	Lubricated operation possible (in which case lubricated operation will always be required)					
Operating pressure	[bar]	2.5 ... 10	2 ... 10	2 ... 12	2 ... 12	1.5 ... 12
	A3 [bar]	2 ... 10		2 ... 12	1.5 ... 12	
Ambient temperature	[°C]	-20 ... +80				
Suitable for use in the food industry ¹⁾	As per manufacturer's declaration					
Corrosion resistance class CRC ²⁾	3					

1) Additional information www.festo.com/sp → User documentation.

2) CRC3: Corrosion resistance class to Festo standard 940 070

Components with heavy corrosion exposure. Externally visible components in direct contact with normal industrial atmosphere or media such as solvents and cleaning agents, where the surface requirement is predominantly functional.

Guided drives DGRF-C, Clean Design

Technical data

Forces [N] and impact energy [J]						
Piston Ø	20	25	32	40	50	63
Theoretical force at 6 bar, advancing	189	295	483	754	1,178	1,870
Theoretical force at 6 bar, retracting	141	247	415	633	990	1,682
Max. impact energy in the end positions with P cushioning	0.2	0.3	0.4	-	-	-

Permissible impact velocity

$$v_{perm.} = \sqrt{\frac{2 \times E_{perm.}}{m_{intrinsic} + m_{Load}}}$$

$v_{perm.}$ Permissible impact velocity

$E_{perm.}$ Maximum impact energy

$m_{intrinsic}$ Moving mass (drive)

m_{Load} Moving payload



Note

These specifications represent the maximum values that can be achieved. Note the maximum permissible impact energy.

Maximum permissible load:

$$m_{Load} = \frac{2 \times E_{perm.}}{v^2} - m_{intrinsic}$$

Weight [g]							
Piston Ø	20	25	32		40	50	63
			P	PPV/PPS			
Product weight with 0 mm stroke	885	1,199	2,090	2,305	3,000	4,800	6,405
Additional weight per 10 mm stroke	52	55	80	78	90	140	143
Moving mass with 0 mm stroke	417	486	902	904	1,065	1,792	2,114
Moving mass per 10 mm stroke	38	38	58	58	65	102	102

Materials

Sectional view

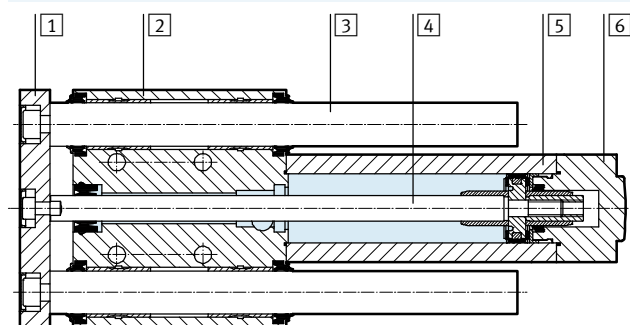

Guided drive	
1	Yoke plate Anodised wrought aluminium alloy
2	Housing Anodised wrought aluminium alloy
3	Guide rod High-alloy stainless steel
4	Piston rod High-alloy stainless steel
5	Cylinder barrel Anodised wrought aluminium alloy
6	Cover
	DGRF-...-20/-25/-32-P Anodised wrought aluminium alloy
	DGRF-...-32-PPV/-PPS Die-cast aluminium, coated
	DGRF-...-40/-50/-63 Die-cast aluminium, coated
-	Seal
	DGRF-... TPE-U (PUR) media sealing (modified for resistance to hydrolysis and cleaning agents)
	DGRF-...-A3 PE
	Note on materials RoHS-compliant

Guided drives DGRF-C, Clean Design

Technical data

Max. payload F as a function of stroke l

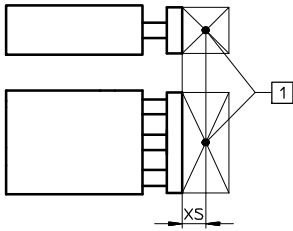

1 Centre of gravity of load

- Load data are based on a distance from the centre of gravity of $X_S = 50\text{ mm}$
- Load data for larger distances on request

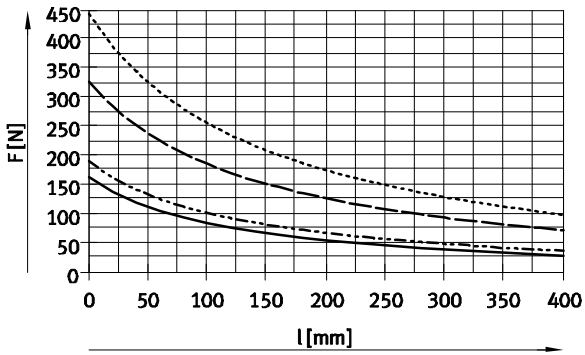

- Ø 20
- - - Ø 25
- · - · - Ø 32/40
- · - · - · - Ø 50/63

Max. torque load M as a function of stroke l

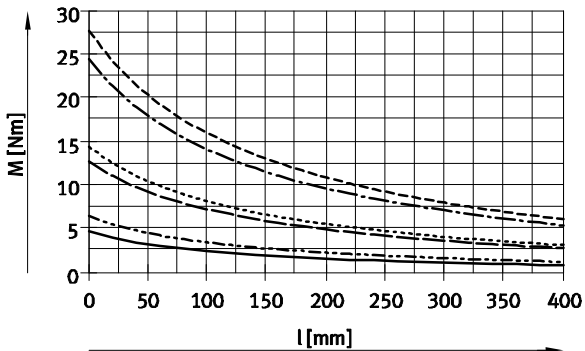
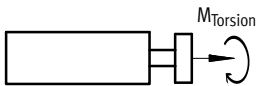

- Ø 20
- - - Ø 25
- · - · - Ø 32
- · - · - · - Ø 40
- · - · - · - · - Ø 50
- · - · - · - · - · - Ø 63

Guided drives DGRF-C, Clean Design

Technical data

FESTO

Deflection of piston rod

Deflection f_1 due to bearing clearance as a function of stroke l

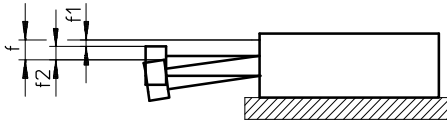

$$f = f_1 + f_2$$

f = Total deflection of piston rod

f_1 = Deflection due to bearing clearance

f_2 = Deflection due to lateral force

Deflection f_1 ,
due to bearing clearance as a function of stroke l

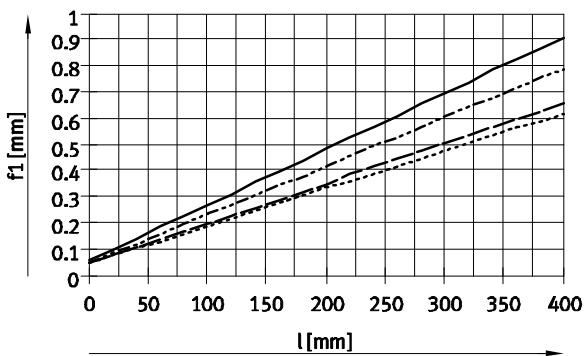

- $\varnothing 20$
- - - $\varnothing 25$
- · - $\varnothing 32/40$
- · · $\varnothing 50/63$

Deflection f_2 ,
due to useful load F and rigidity c as a function of stroke l

$$f_2 = \frac{F}{c}$$

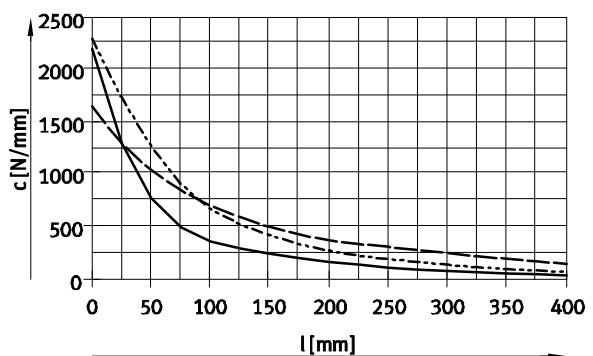

- $\varnothing 20/25$
- - - $\varnothing 32/40$
- · - $\varnothing 50/63$
- · · $\varnothing 20$

End-position sensing

With proximity sensor SMT-C1

A minimum stroke is required to be able to sense both end positions at the cylinder.

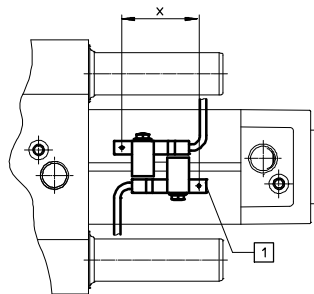

- 1 Position of the proximity sensor within the housing.

Piston \varnothing	32	40	50	63
Minimum stroke x [mm]	35	35	35	30

With mounting kit SMB-8-C and proximity sensor CRSMT-8M

A minimum stroke is required to be able to sense both end positions at the cylinder.

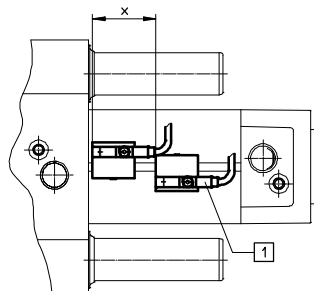

- 1 Position of the proximity sensor within the housing.

Piston \varnothing	32	40	50	63
Minimum stroke x [mm]	30	30	30	30

Guided drives DGRF-C, Clean Design

Technical data

FESTO

Dimensions

Download CAD data → www.festo.com

DGRF-...-PPV – pneumatic cushioning, adjustable at both ends

DGRF-...-PPS – pneumatic cushioning, self-adjusting at both ends

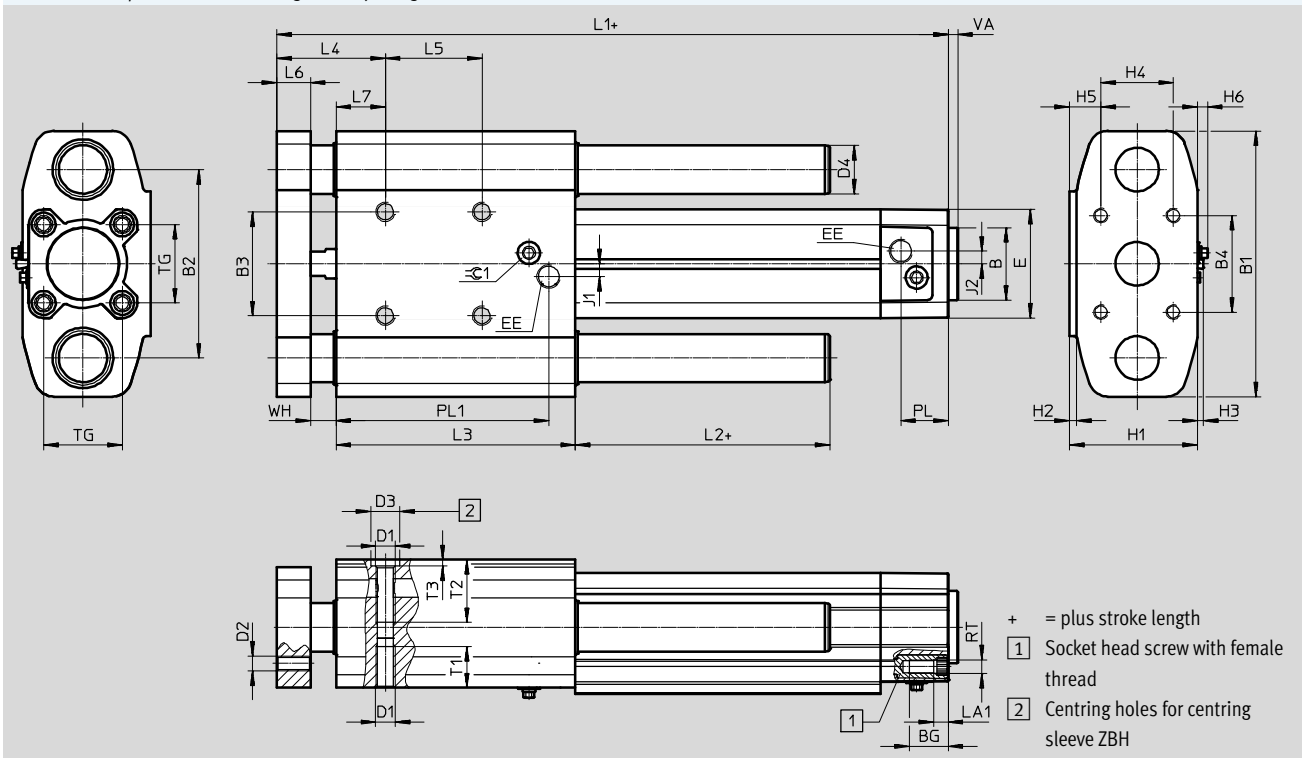

∅	B	BG	B1	B2	B3 ²⁾	B4	D1	D2	D3 ³⁾	D4	E	EE	H1	H2
[mm]	∅ d11								∅ H7	∅				
32	30	16	110	78	43	40	M8	M6	12	20	45	G ¹ / ₈	53	3
40	35	16	120	88	51	50	M8	M6	12	20	54	G ¹ / ₄	61	3
50	40	17	148	110	64	60	M8	M8	12	25	64	G ¹ / ₄	73	3
63	45	17	162	125	80	80	M10	M8	12	25	75	G ³ / ₈	84	3

∅	H3 ¹⁾	H4	H5	H6	J1	J2	L1	L2	L3	L4	L5
[mm]											
32	2.5	30	13	5.6	5.3	5.3	177.6 +1.9/-1.2	7.4	99	45 +1.5/-1.1	40
40	3	30	17	5.6	4	4	183.5 +1.9/-1.3	7.5	99	45 +1.5/-1.1	40
50	2	40	18	7.5	5.5	5.5	193.5 +1.7/-1.3	7.7	105	50 +1.3/-1.2	40
63	2	40	23.5	9.3	6.3	6.3	207.3 +1.7/-1.3	7.5	105	50 +1.3/-1.2	40

∅	L6	L7	LA1	PL	PL1	RT	T1	T2	T3	TG	VA	WH	⊖ 1
[mm]													
32	14	20.4	5.6	19.5	88	M6	17	26	2.6	32.5	4	10.6 +1/-0.9	4
40	14	20.5	5.6	22.5	83	M6	17	26	2.6	38	4	10.5 ±1/-1	4
50	16	22.7	6.1	22.5	89	M8	17	20	2.6	46.5	4	11.3 +0.8/-1	4
63	20	18.5	6.1	27.5	88	M8	17	24	2.6	56.5	4	11.5 +0.8/-1	4

1) Only in combination with sensor mounting rail (DGRF-...-R)

2) Tolerance between centring holes ±0.02 mm

3) Two centring sleeves included in the scope of delivery

Guided drives DGRF-C, Clean Design

Ordering data – Modular products

Ordering table									
Size	20	25	32	40	50	63	Condi- tions	Code	Entry code
M Module No.	562216	562217	563366	562219	562220	562221			
Function	Guided drive							DGRF	DGRF
Product version	Easy-to-clean design							-C	-C
Guide	Plain-bearing guide							-GF	-GF
Piston Ø [mm]	20	25	32	40	50	63		-...	
Stroke [mm]	10 ... 400							-...	
Cushioning	Elastic cushioning rings at both ends							-P	
	Pneumatic cushioning, adjustable at both ends							-PPV	
	Pneumatic cushioning, self-adjusting at both ends							-PPS	
Position sensing	Via proximity sensor						1	A	
Sensor mounting, external	Mounting rail for proximity sensor						1	-R	
O Wiper seal variant	Standard								
	For unlubricated operation							-A3	

1 **A, R** Always included with piston Ø 32 ... 63.

Transfer order code

Guided drives DGRF-C, Clean Design

Accessories

With DGRF-...-PPV¹⁾/-PPS permissible:

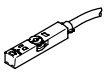

Ordering data – Proximity sensor for T-slot, magneto-resistive						Technical data → Internet: smt
	Type of mounting	Switching output	Electrical connection	Cable length [m]	Part No.	Type
N/O contact						
	Insertable in the slot from above, flush with the mounting kit	PNP	Cable, 3-wire	5.0	574380	CRSMT-8M-PS-24V-K-5,0-OE
			Cable, 3-wire	10.0	574381	CRSMT-8M-PS-24V-K-10,0-OE
			Plug M8x1, 3-pin	0.3	574383	CRSMT-8M-PS-24V-K-0,3-M8D
			Plug M12x1, 3-pin	0.3	574382	CRSMT-8M-PS-24V-K-0,3-M12

1) Possible when ordering cylinders from 02/2014 (series E2).

Ordering data – Mounting kit			
	Description	Part No.	Type
	For mounting the proximity sensor CRSMT-8M on the mounting rail	1806790	SMB-8-C

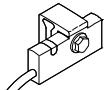



With DGRF-...-P/-PPV/-PPS permissible:

Ordering data – Proximity sensor for T-slot, magneto-resistive						Technical data → Internet: smt
	Type of mounting	Switching output	Electrical connection	Cable length [m]	Part No.	Type
N/O contact						
	Is mounted on the mounting rail	PNP	Cable, 3-wire	5.0	571339	SMT-C1-PS-24V-K-5,0-OE
			Plug M8x1, 3-pin	0.3	571342	SMT-C1-PS-24V-K-0,3-M8D
			Plug M12x1, 3-pin	0.3	571341	SMT-C1-PS-24V-K-0,3-M12

Ordering data – Connecting cables for SMT-C1-...					Technical data → Internet: nebu
	Electrical connection, left	Electrical connection, right	Cable length [m]	Part No.	Type
	Straight socket, M8x1, 3-pin	Cable, open end, 3-wire	2.5	541333	NEBU-M8G3-K-2.5-LE3
			5	541334	NEBU-M8G3-K-5-LE3
	Straight socket, M12x1, 5-pin	Cable, open end, 3-wire	2.5	541363	NEBU-M12G5-K-2.5-LE3
			5	541364	NEBU-M12G5-K-5-LE3
	Angled socket, M8x1, 3-pin	Cable, open end, 3-wire	2.5	541338	NEBU-M8W3-K-2.5-LE3
			5	541341	NEBU-M8W3-K-5-LE3
	Angled socket, M12x1, 5-pin	Cable, open end, 3-wire	2.5	541367	NEBU-M12W5-K-2.5-LE3
			5	541370	NEBU-M12W5-K-5-LE3

Guided drives DGRF-C, Clean Design

Accessories



Ordering data – Push-in fittings					Technical data → Internet: quick star		
	Connection		Material	Weight [g]	Part No.	Type	PU ²⁾
	Thread	Tubing O.D. Ø					
With external hexagon							
	M5	4	Nickel- and chrome-plated brass	–	578334	NPQH-D-M5-Q4-P10	10
		6		–	578335	NPQH-D-M5-Q6-P10	
	G1/8	4		6.1	578338	NPQH-D-G18-Q4-P10	
		6		9	578339	NPQH-D-G18-Q6-P10	
		8		11.4	578340	NPQH-D-G18-Q8-P10	
	G1/4	6		12.7	578341	NPQH-D-G14-Q6-P10	
		8		13.6	578342	NPQH-D-G14-Q8-P10	
		10		17.4	578343	NPQH-D-G14-Q10-P10	
	G3/8	8		20.1	578345	NPQH-D-G38-Q8-P10	
		10		22.6	578346	NPQH-D-G38-Q10-P10	
		12		28.9	578347	NPQH-D-G38-Q12-P10	
		M5		4	Stainless steel	6.0	
6			8.4	162861		CRQS-M5-6 ¹⁾	
R1/8		4	8.7	132643		CRQS-1/8-4	
		6	9.9	162862		CRQS-1/8-6	
		8	12	162863		CRQS-1/8-8	
R1/4		6	18	132644		CRQS-1/4-6	
		8	18	162864		CRQS-1/4-8	
		10	22	162865		CRQS-1/4-10	
R3/8		10	29	162866		CRQS-3/8-10	
		12	37	162867		CRQS-3/8-12	
		R1/8	4	Polypropylene		2.5	133041
	6		3.0		133043	NPQP-D-R18-Q6-FD-P10	
	8		4.5		133045	NPQP-D-R18-Q8-FD-P10	
	R1/4	6	3.5		133044	NPQP-D-R14-Q6-FD-P10	
		8	4.5		133046	NPQP-D-R14-Q8-FD-P10	
		10	7.0		133047	NPQP-D-R14-Q10-FD-P10	
	R3/8	10	8.0		133048	NPQP-D-R38-Q10-FD-P10	
		12	12.0		133049	NPQP-D-R38-Q12-FD-P10	
With internal hexagon							
	M5	4	Nickel- and chrome-plated brass	4.6	578370	NPQH-DK-M5-Q4-P10	10
		6		8.6	578371	NPQH-DK-M5-Q6-P10	
	G1/8	4		–	578374	NPQH-DK-G18-Q4-P10	
		6		–	578375	NPQH-DK-G18-Q6-P10	
		8		–	578376	NPQH-DK-G18-Q8-P10	
	G1/4	8		–	578377	NPQH-DK-G14-Q8-P10	
		10		–	578378	NPQH-DK-G14-Q10-P10	
	G3/8	12		–	578379	NPQH-DK-G38-Q12-P10	
	M5	4	Stainless steel	5	132328	CRQS-M5-4- ¹⁾	1
		6		7.7	132329	CRQS-M5-6- ¹⁾	
	R1/8	6		8.4	132330	CRQS-1/8-6-I	
		8		12	132331	CRQS-1/8-8-I	
	R1/4	8		15	132332	CRQS-1/4-8-I	
		10		21	132333	CRQS-1/4-10-I	
	R3/8	10		24	132334	CRQS-3/8-10-I	

1) With sealing ring
2) Packaging unit quantity



Guided drives DGRF-C, Clean Design

Accessories

FESTO

Ordering data – Push-in L-fittings					Technical data → Internet: quick star					
	Connection		Material	Weight [g]	Part No.	Type	PU ²⁾			
	Thread	Tubing O.D. Ø								
With external hexagon										
	M5	4	Nickel- and chrome-plated brass	8.8	578276	NPQH-L-M5-Q4-P10	10			
		6		11.9	578277	NPQH-L-M5-Q6-P10				
	G1/8	4		15.7	578280	NPQH-L-G18-Q4-P10				
		6		18.5	578281	NPQH-L-G18-Q6-P10				
		8		22	578282	NPQH-L-G18-Q8-P10				
	G1/4	6		21.8	578283	NPQH-L-G14-Q6-P10				
		8		25.3	578284	NPQH-L-G14-Q8-P10				
		10		34	578285	NPQH-L-G14-Q10-P10				
		12		58.5	578286	NPQH-L-G14-Q12-P10				
	G3/8	8		37.7	578287	NPQH-L-G38-Q8-P10				
		10		39.2	578288	NPQH-L-G38-Q10-P10				
		12		56.1	578289	NPQH-L-G38-Q12-P10				
	M5	4	Stainless steel	12	162870	CRQSL-M5-4 ¹⁾	1			
		6		18	162871	CRQSL-M5-6 ¹⁾				
	R1/8	4		14	132598	CRQSL-1/8-4				
		6		19	162872	CRQSL-1/8-6				
		8		26	162873	CRQSL-1/8-8				
	R1/4	6		26	132599	CRQSL-1/4-6				
		8		30	162874	CRQSL-1/4-8				
		10		42	162875	CRQSL-1/4-10				
	R3/8	10		49	162876	CRQSL-3/8-10				
		12		65	162877	CRQSL-3/8-12				
		R1/8		4	Polypropylene	4.0		133051	NPQP-L-R18-Q4-FD-P10	10
				6		5.0		133053	NPQP-L-R18-Q6-FD-P10	
8			7.0	133055		NPQP-L-R18-Q8-FD-P10				
R1/4		6	5.5	133054		NPQP-L-R14-Q6-FD-P10				
		8	7.5	133056		NPQP-L-R14-Q8-FD-P10				
		10	12	133057		NPQP-L-R14-Q10-FD-P10				
R3/8		10	13	133058		NPQP-L-R38-Q10-FD-P10				
		12	18	133059		NPQP-L-R38-Q12-FD-P10				

- 1) With sealing ring
2) Packaging unit quantity



Ordering data – One-way flow control valves					Technical data → Internet: crgrla		
	Connection		Material	Part No.	Type	PU ¹⁾	
	Thread	For push-in fitting					
	M5	CRQS/CRQSL/CRQST,	Electropolished stainless steel casting	161403	CRGRLA-M5-B	1	
	G1/8	Quick Star		161404	CRGRLA-1/8-B		
	G1/4			161405	CRGRLA-1/4-B		
	G3/8			161406	CRGRLA-3/8-B		
	G1/8	Push-in connector is integrated	Chrome-plated metal	195597	GRLA-F-1/8-QS-4-D	1	
				195598	GRLA-F-1/8-QS-6-D		
				195599	GRLA-F-1/8-QS-8-D		
	G1/4			195600	GRLA-F-1/4-QS-6-D		
				195601	GRLA-F-1/4-QS-8-D		

- 1) Packaging unit quantity

Guided drives DGRF-C, Clean Design

Accessories

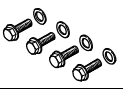
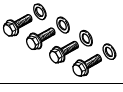
Ordering data – Plastic tubing, standard O.D.		Technical data → Internet: tubing	
		Type	
	Approved for use in the food industry and resistant to hydrolysis	PUN-H	
	Good resistance to chemicals and hydrolysis	PLN	
	Pneumatic tubing with resistance to high temperatures and chemicals	PFAN	

Ordering data – Blanking screws, corrosion-resistant					
	For Ø	Description	Part No.	Type	PU ¹⁾
For mounting thread on the guide					
	20, 25	With cover plate	543715	DAMD-P-M6-12-R1	4
	32, 40, 50		543716	DAMD-P-M8-16-R1	
	63		543717	DAMD-P-M10-16-R1	
For mounting thread on the end cap					
	20, 25	With cover plate	543714	DAMD-P-M5-10-R1	4
	32 ²⁾		543715	DAMD-P-M6-12-R1	
	32 ³⁾ , 40	–	1355016	DAMD-PS-M6-12-R1	
	50, 63		650121	DAMD-PS-M8-16-R1	

- 1) Packaging unit quantity
- 2) For cylinder with P cushioning
- 3) For cylinder with PPV/PPS cushioning

Ordering data – Centring sleeves		Technical data → Internet: zbh		
	For Ø	Part No.	Type	PU ¹⁾
	20, 25	150927	ZBH-9	10
	32, 40, 50, 63	189653	ZBH-12	

- 1) Packaging unit quantity