

Modular electrical terminal CPX-P



Terminal CPX-P

Key features

FESTO

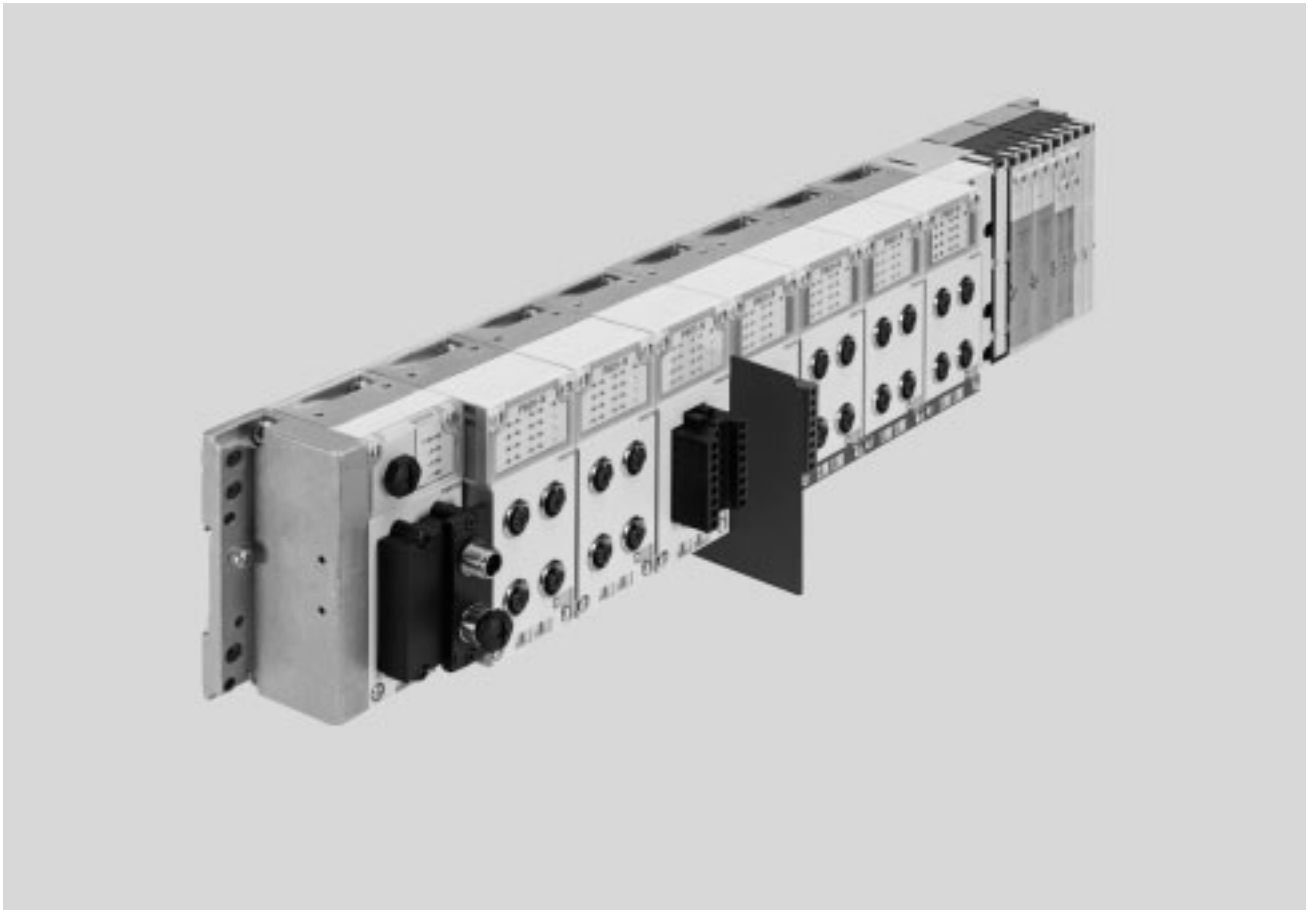

Key features

Installation concept	Electrical components	Assembly	Operation
<ul style="list-style-type: none">• Economical from the smallest configuration up to the maximum number of modules• Up to 9 electrical input/output modules plus bus nodes and pneumatic interface/electronics modules for valves• Extensive range of functions and connection options for the electrical modules• Choice of connection technology for technically and economically optimised connections• Can be used as a dedicated remote I/O module	<ul style="list-style-type: none">• High operating voltage tolerance ($\pm 25\%$)• Open to all fieldbus protocols and Ethernet• IT services and TCP/IP such as remote maintenance, remote diagnostics, web server, text message and e-mail alert• Digital inputs and outputs, 4-/8-/16-way, optionally available with individual channel diagnostics• Analogue inputs and outputs, 2-/4-way• Input modules for connecting NAMUR sensors• IP65 or IP20	<ul style="list-style-type: none">• Wall or H-rail mounting, also on mobile units• Conversions/extensions are possible at any time, individual linking• Modular system offering a range of configuration options• Fully assembled and tested unit• Lower selection, ordering, assembly and commissioning costs thanks to the central CPX-P terminal• Choice of pneumatic components for optimised control loop system design	<ul style="list-style-type: none">• Fast troubleshooting thanks to an extensive selection of LEDs (some of which are multi-coloured) on the bus node and on all I/O modules• Supports module and channel-oriented diagnostics• On-the-spot diagnostics in plain text via operator unit (CPX-MMI)• Fieldbus/Ethernet remote diagnostics• Innovative diagnostic support with integrated web server/web monitor or maintenance tool (CPX-FMT) with USB adapter (NEFC) for PC• Optimised commissioning thanks to parameterisable functions• Reliability of service with connection blocks and modules that are quick to replace without changing the wiring

Terminal CPX-P

Key features

Variants for controlling the CPX-P terminal (with bus node, without preprocessing)

Bus node

Different bus nodes are used to integrate the terminal in the control systems of various manufacturers. The CPX-P terminal can therefore be operated on commonly used fieldbus systems:

- PROFIBUS DP
- PROFINET
- DeviceNet

Integration in universal networks based on Ethernet opens up new possibilities. Faster data transmission, real-time capability and above all additional IT services such as file transfer, web server, web monitor as integrated website in the CPX-P

terminal, text message/e-mail alerts, etc. open up a wide range of synergies.

These include standardised and universal communication technology across all areas, including operating level, management level and field

level in the production environment, with protection to IP65. The following protocols are supported:

- EtherNet/IP
- Modbus/TCP
- PROFINET

Bus node

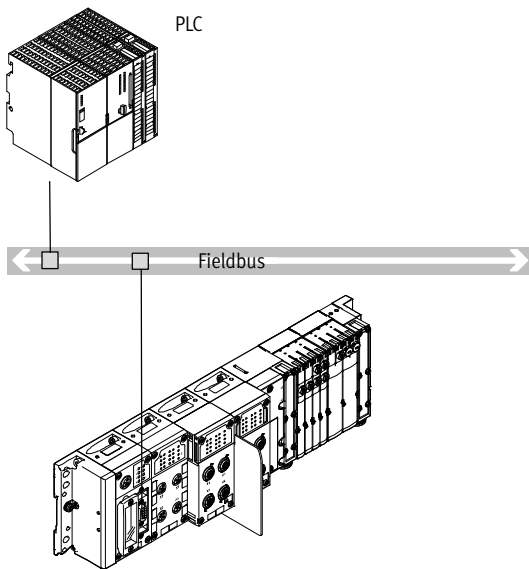

- Communication with higher-order controller via fieldbus
- No preprocessing

- Fieldbus protocol dependent on CPX bus node used
- Up to 90 I/Os, depending on the bus node used

Industrial Ethernet bus node

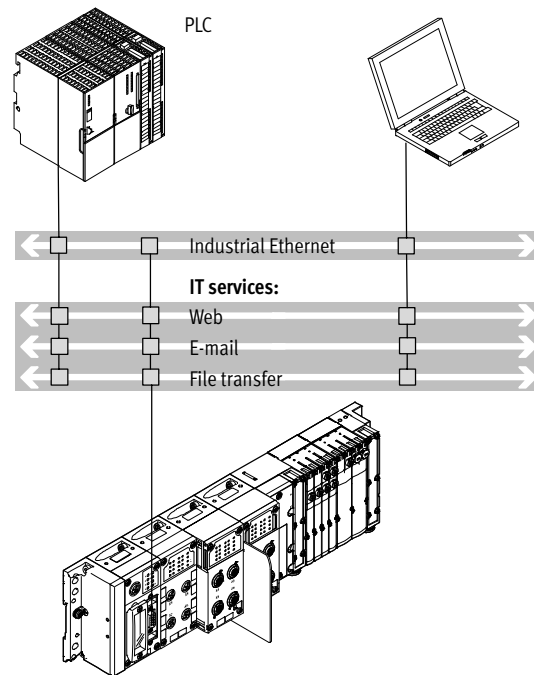

- Connection to a higher-order controller directly via EtherNet/IP, Modbus/TCP or PROFINET
- No preprocessing

- Monitoring via Ethernet and web applications
- Up to 300 I/Os

Note

Every electrical connection can be combined with an appropriate number of I/O modules and/or pneumatic components, depending on its address capacity.

Likewise, every pneumatic variant of the CPX-P terminal can be operated with every electrical connection variant.

Terminal CPX-P

Key features

Connection of inputs and outputs to the CPX-P terminal

Digital and analogue CPX I/O modules

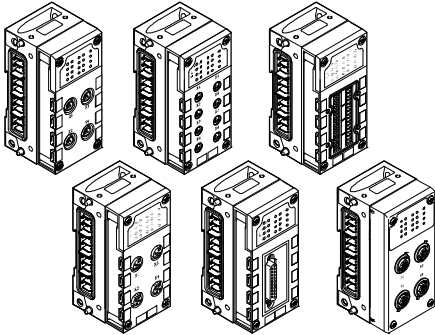

Electrical connection

The connection technology for sensors and additional actuators offers a wide range of digital and analogue input and output modules and is freely selectable – as appropriate to your standard or application.

The input/output modules can be combined as required with the connection blocks:

- M12, 5-pin
- M12, 5-pin, with quick lock and metal thread
- M8, 3-pin
- M8, 4-pin
- Sub-D, 25-pin
- Harax®, 4-pin
- CageClamp® (with cover also to IP65/67)

CPX modules for NAMUR sensors

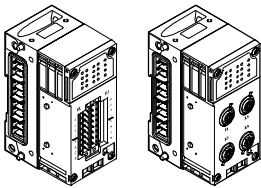

Electrical connection

The electronics modules for NAMUR sensors can only be combined with certain connection blocks.

The input modules can be combined as required with the connection blocks:

- M12, 4-pin
- Screw terminal and slotted terminal

CPX modules for NAMUR sensors, intrinsically safe circuits for ATEX applications

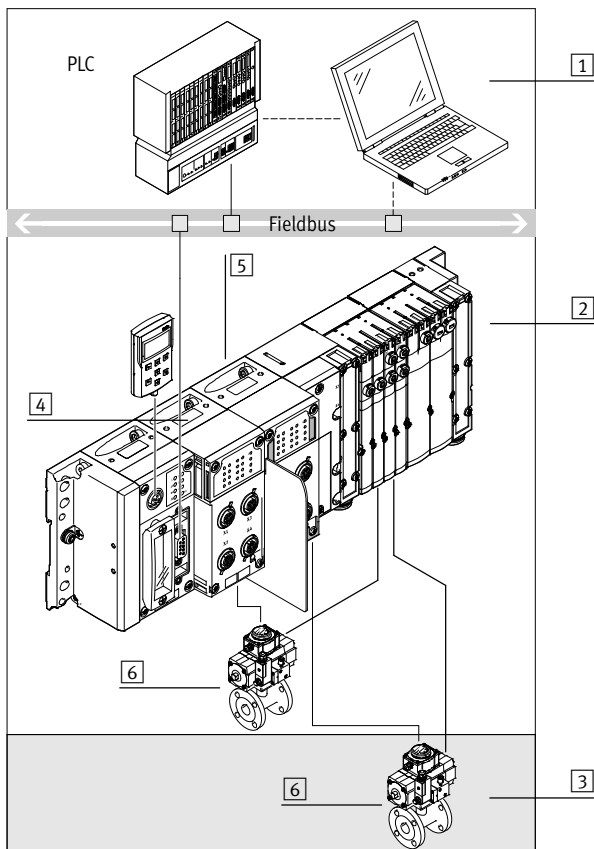

- 1 Higher-order controller
- 2 Non-ATEX zone; non-intrinsically safe circuits are permitted
- 3 ATEX zone; only intrinsically safe circuits are permitted
- 4 CPX input module for NAMUR sensors, non-intrinsically safe design
- 5 CPX input module for NAMUR sensors, intrinsically safe design
- 6 Actuator/machine component with NAMUR sensors

CPX-P modules are suitable for configuring intrinsically safe or non-intrinsically safe circuits depending on the design selected. This enables components from both safe and hazardous zones to be connected to the CPX-P terminal. The components for the intrinsically safe zone are marked in blue or entirely coloured blue to distinguish them visually.

Note

Intrinsically safe circuits are circuits which release so little energy during operation, or in the event of certain faults under specified test conditions, that no ignition can occur in a particular potentially explosive atmosphere.

Terminal CPX-P

Key features

Pneumatic variants of the CPX-P terminal

With valve terminal MPA-S – centralised

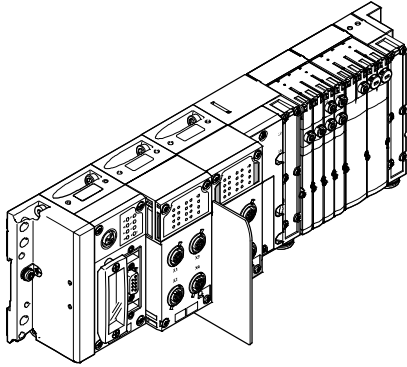

The electrical CPX-P terminal is a modular peripheral system for valve terminals.

The system is specifically designed so that the valve terminal can be adapted to suit different applications.

The modular system design lets you configure the number of valves, inputs and additional outputs to suit the application.

Ordering

The CPX-P terminal with valve terminal is fully assembled according to your order specifications and individually tested. The finished valve terminal consists of the electrical peripherals including the desired actuation and the selected components from the MPA-S modular system.

The CPX-P terminal with valve terminal is ordered using two separate order codes. One order code defines the electrical peripherals type CPX-P, while the other specifies the pneumatic components of the valve terminal.

The electrical peripherals type CPX-P can also be configured without a valve terminal and can be used on a fieldbus. For this order, only the order code for the electrical peripherals is required.

The order lists for the pneumatic components can be found on

➔ Internet: mpa-s
(valve terminal MPA-S)

Terminal CPX-P

Peripherals overview

FESTO

Complete overview of modules

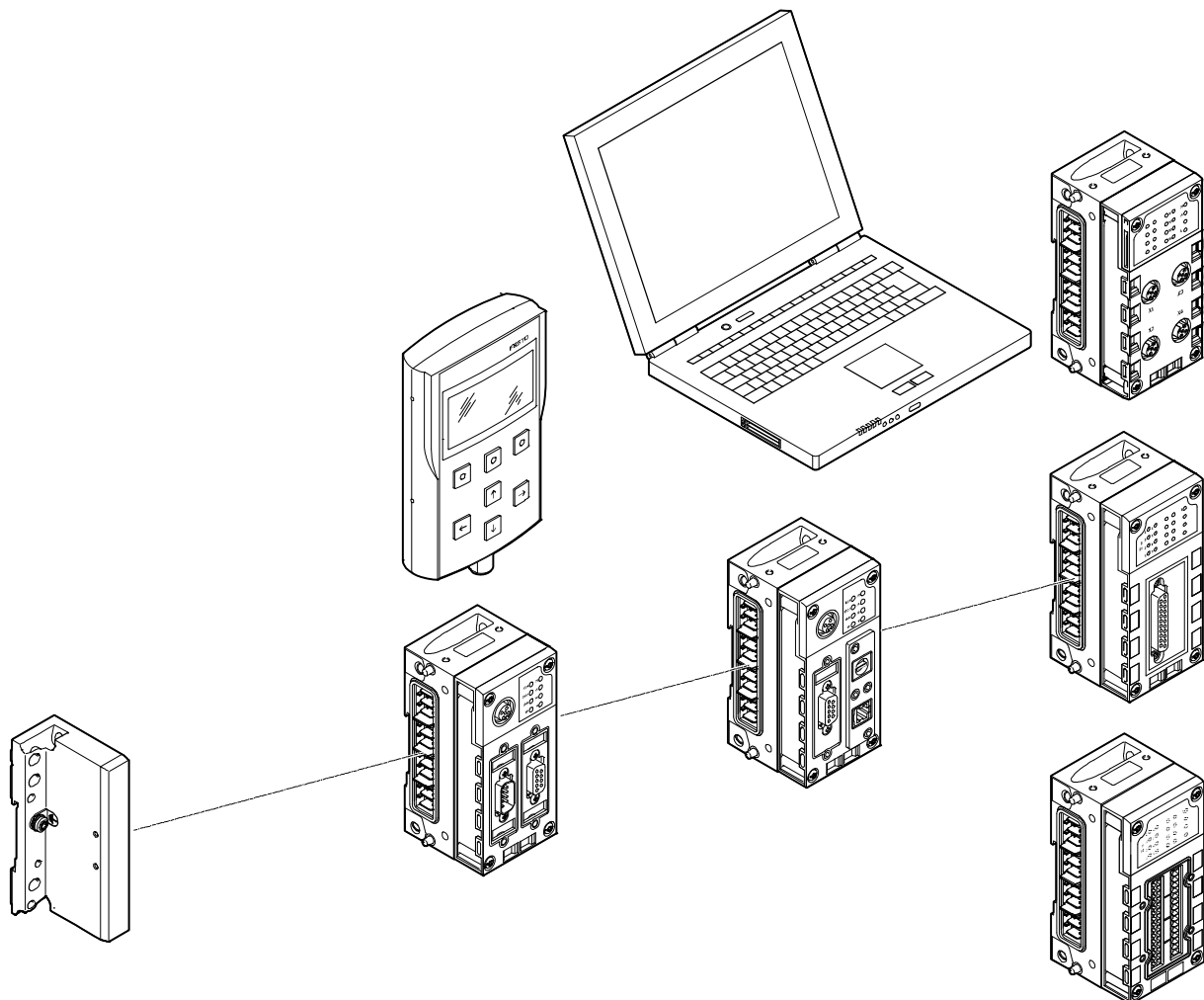

End plate

- Mounting holes for wall mounting
- Functional earth connection

Bus node

- Fieldbus/Industrial Ethernet connection using various types of connection technology
- Setting of fieldbus parameters via DIL switch
- Display of fieldbus and peripheral equipment status via LED

Operator unit

- Connection to bus nodes or control block
- Display and modification of parameter settings
- Plain-text display for texts, messages (e.g. individual channel diagnostics, condition monitoring), menus, etc.

Control block

- Remote unit CPX-FEC
- Connection via Ethernet TCP/IP or Sub-D programming interface
- Setting of operating modes via DIL switch and program selection via rotary switch

Input/output modules

- Combination of
- Interlinking block
 - Electronics module
 - Connection block

Terminal CPX-P

Peripherals overview

FESTO

Complete overview of modules

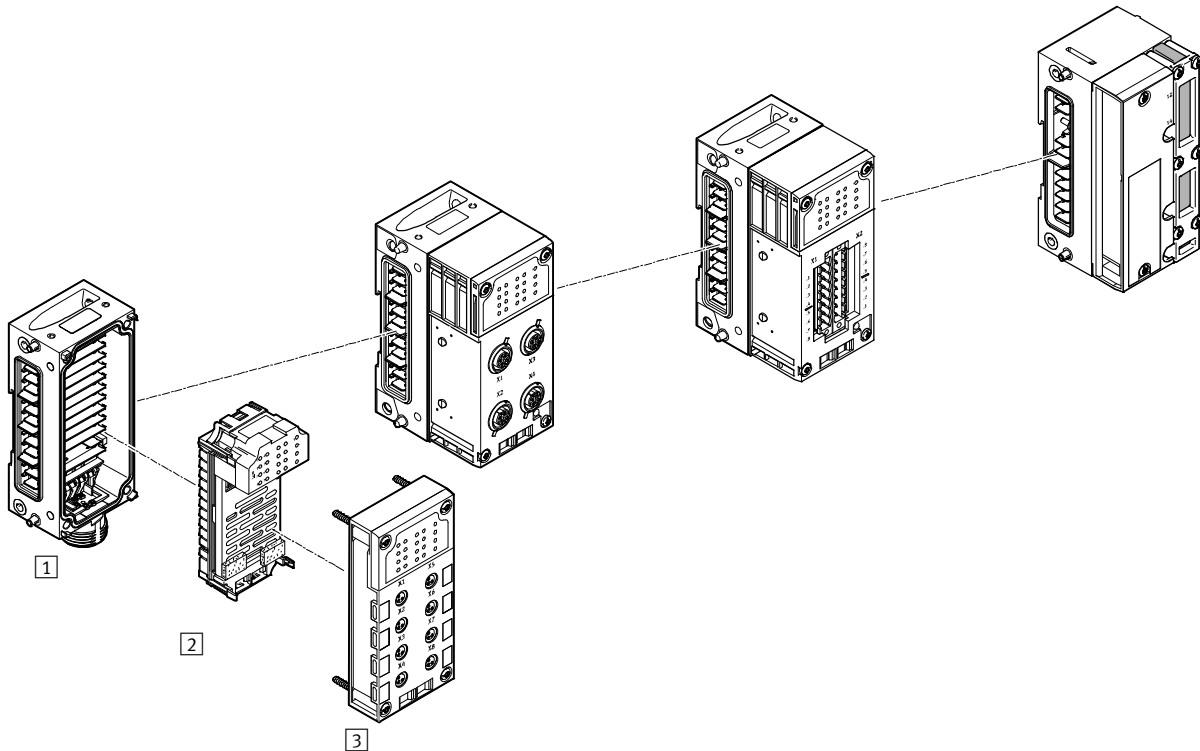

Input/output modules

1 Interlinking block

- Internal linking of the power supply and serial communication
- External power supply for the entire system
- Additional power supply for outputs
- Connection accessories for 7/8"
- Individual linking with M6 screws, individually expandable

2 Electronics module

- Digital inputs for connecting the sensors
- Digital outputs for activating additional actuators
- Analogue inputs
- Analogue outputs

3 Connection block

- Choice of connection technology
- Protection class IP65 or IP20
- Can be combined with the electronics modules
- Connection accessories for M8/M12/Sub-D/quick connector, etc.
- M8/M12/Sub-D, etc. connecting cables
- Modular system for connecting cables

Pneumatic interface

- MPA-S

Terminal CPX-P

Peripherals overview

FESTO

Individual overview of modules

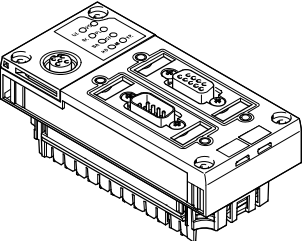
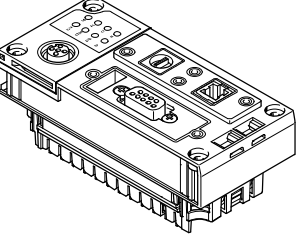
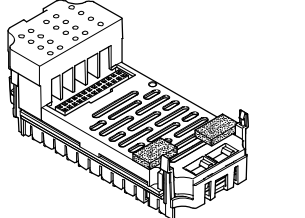
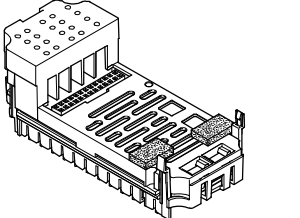
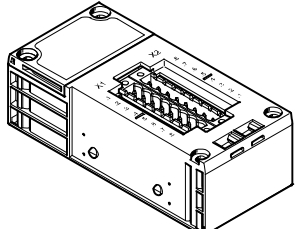
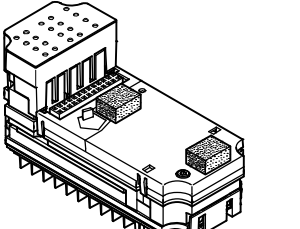
Bus node	→ 71	Control block	→ 39
	<p>Bus node for</p> <ul style="list-style-type: none"> • PROFIBUS DP • DeviceNet • EtherNet/IP (integrated web server) • PROFINET (integrated web server) 		<p>CPX-FEC</p> <ul style="list-style-type: none"> • Programming with FST • Ethernet interface • Modbus/TCP • EasyIP • Integrated web server • Sub-D programming interface
Plastic connection block	<p>Direct machine mounting (connection block to IP65/IP67)</p> <ul style="list-style-type: none"> • M8-3POL • M8-4POL • M12-5POL • M12-5POL quick lock, metal thread screened • Sub-D • Quick connector • Spring-loaded terminal with cover <p>Protected fitting space (protection class IP20)</p> <ul style="list-style-type: none"> • Spring-loaded terminal <p>Screening concept</p> <ul style="list-style-type: none"> • Optional screening plate for connection block with M12 connection technology 	Metal connection block	<p>Direct machine mounting (connection block to IP65/IP67)</p> <ul style="list-style-type: none"> • M12-5POL
Digital electronics module for inputs/outputs	→ 158	Analogue electronics module for inputs/outputs	→ 71
	<p>Digital inputs</p> <ul style="list-style-type: none"> • 16 digital inputs <p>Digital outputs</p> <ul style="list-style-type: none"> • 4 digital outputs (1 A per channel, individual channel diagnostics) • 8 digital outputs (0.5 A per channel, individual channel diagnostics) 		<p>Analogue inputs</p> <ul style="list-style-type: none"> • 4 analogue inputs (1 ... 5 V, 0 ... 10 V, -5 ... +5 V, -10 ... +10 V, 0 ... 20 mA, 4 ... 20 mA, -20 ... +20 mA) <p>Analogue outputs</p> <ul style="list-style-type: none"> • 2 analogue outputs (0 ... 10 V DC, 0 ... 20 mA, 4 ... 20 mA)
Connection block for NAMUR sensors	<p>Direct machine mounting (connection block to IP65)</p> <ul style="list-style-type: none"> • M12-4POL <p>Protected fitting space (connection block to IP20)</p> <ul style="list-style-type: none"> • Screw terminal • Spring-loaded terminal 	Digital electronics module for NAMUR sensors	→ 63
			<p>Digital inputs</p> <ul style="list-style-type: none"> • 8 digital inputs for NAMUR sensors or wired mechanical contacts • Intrinsically safe design with additional protection measures in the event of failure

Terminal CPX-P

Peripherals overview

Individual overview of modules

Metal interlinking block – Individual linking

→ 86

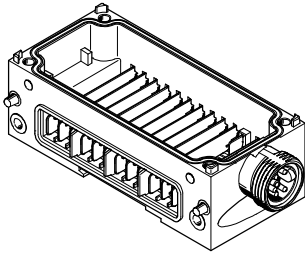

System linking

- Different voltage values for supplying the modules
- Serial communication between the modules

System supply

- 7/8", 5-pin

In addition to system linking, power supply for the

- electronics plus sensors (8 A)
- valves plus actuators (8 A)

Additional power supply

In addition to system linking, power supply for the

- actuators (8 A per supply)

Expandability

- Can be expanded as required by up to 10 interlinking blocks

-  - Note

The 7/8" supply is subject to the following restriction due to the available accessories:

- 5-pin 8 A

Pneumatic interface MPA-S

→ 92

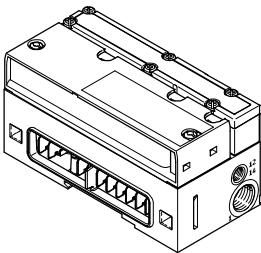

Valve terminal

- MPA1 (360 l/min)
- MPA2 (700 l/min)
- Up to 128 solenoid coils
- Up to 16 modules can be configured

End plate

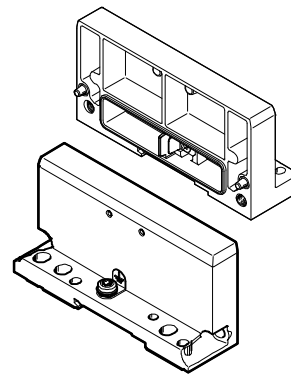

End plate

- Left-hand
- Right-hand (for use without valves)

Terminal CPX-P

Peripherals overview

General basic data and guidelines

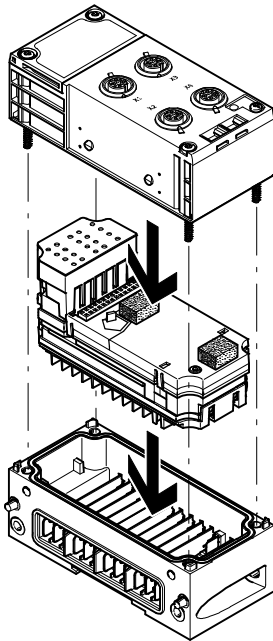

Max. 11 modules in total:

- One bus node and/or one control block
- Up to 9 additional input/output modules
- In addition a pneumatic interface
 - Always positioned as the last module on the right-hand side
 - 16 MPA modules can be configured

- Address capacity max. 512 inputs and 512 outputs, depending on bus node or control block
- One interlinking block with system supply
- Multiple interlinking blocks with additional power supply, always positioned to the right of the interlinking block with system supply

- The connection blocks can, with a few exceptions, be combined with the electronics modules for inputs/outputs (→ table below)
- The electronics modules for inputs/outputs can be combined with various interlinking blocks

Combinations of connection blocks and digital and analogue electronics modules for inputs and outputs

	Digital electronics modules					Analogue electronics modules	
	For inputs	For outputs		For NAMUR sensors		CPX-4AE-U-I	CPX-2AA-U-I
	CPX-16DE	CPX-4DA	CPX-8DA	CPX-P-8DE-N	CPX-P-8DE-N-IS		
Connection blocks, plastic design							
CPX-AB-8-M8-3POL	-	■	■	-	-	-	-
CPX-AB-8-M8X2-4POL	■	■	■	-	-	-	-
CPX-AB-4-M12x2-5POL	-	■	■	-	-	■	■
CPX-AB-4-M12x2-5POL-R	-	■	■	-	-	■	■
CPX-P-AB-4XM12-4POL	-	-	-	■	-	-	-
CPX-P-AB-4XM12-4POL-8DE-N-IS	-	-	-	-	■	-	-
CPX-AB-8-KL-4POL	■	■	■	-	-	■	■
CPX-P-AB-2XKL-8POL	-	-	-	■	-	-	-
CPX-P-AB-2XKL-8POL-8DE-N-IS	-	-	-	-	■	-	-
CPX-AB-1-SUB-BU-25POL	■	■	■	-	-	■	■
CPX-AB-4-HAR-4POL	-	■	■	-	-	-	-
Connection blocks, metal design							
CPX-M-AB-4-M12X2-5POL	-	■	■	-	-	■	■

Terminal CPX-P

Key features – Electrical components

Electrical connection – Connection block with M8, 3-pin connection

CPX-AB-8-M8-3POL

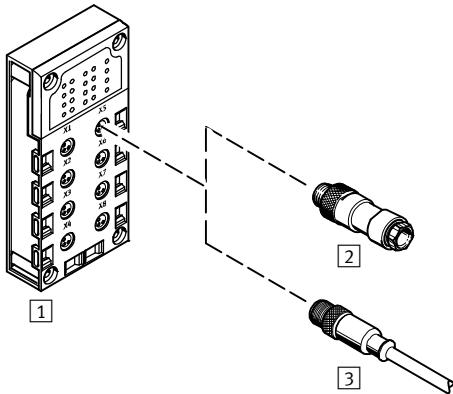

- Compact for pre-assembled individual connection
- 8 sockets
- 3-pin design for connecting 1 channel per socket

-  - Note

Festo delivers pre-assembled M8/M12 connecting cables (NEBU modular system) on request:

- Tailored to the application
- Perfect fit
- Saves installation

Combination of connection block and electrical connection technology

Connection block	Connection technology	Plug connector/connecting cable	Selectable connection technology
1 CPX-AB-8-M8-3POL	Socket, M8, 3-pin	2 SEA-GS-M8	Solder lugs
		2 SEA-3GS-M8-S	Screw terminals
		3 KM8-M8-GSGD-... (pre-assembled connecting cable)	Socket, M8, 3-pin
		3 NEBU-...-M8G3 (modular system for choice of connecting cables)	Socket, M5, 3-pin
			Socket, M8, 3-pin
Socket, M8, 4-pin			
			Socket, M12, 5-pin
			Open cable end

Terminal CPX-P

Key features – Electrical components

Electrical connection – Connection block with M8, 4-pin connection

CPX-AB-8-M8X2-4POL

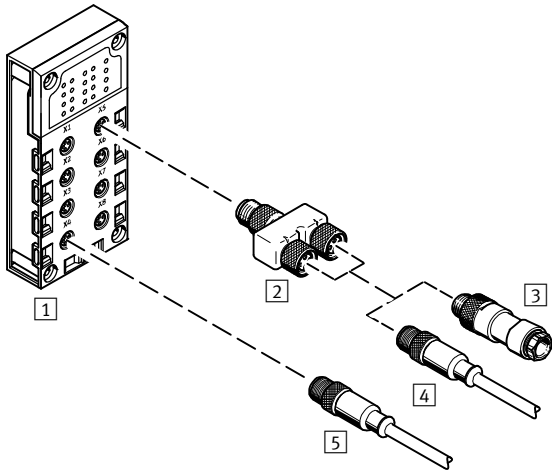

- Compact for pre-assembled individual connection
- 8 sockets
- 4-pin design for connecting 2 channels per socket

Combination of connection block and electrical connection technology						
Connection block	Connection technology	Plug connector/ connecting cable	Selectable connection technology	Plug connector/ connecting cable	Selectable connection technology	
1 CPX-AB-8-M8X2-4POL	Socket, M8, 4-pin	4 NEBU-...-M8G4 (modular system for choice of connecting cables)	Socket, M5, 3-pin	-	-	
			Socket, M8, 3-pin	-	-	
			Socket, M8, 4-pin	-	-	
			Socket, M12, 5-pin	-	-	
			Open cable end	-	-	
		2 NEDU-M8D3-M8T4 (T-adapter)	1x plug M8, 4-pin to 2x socket M8, 3-pin		3 SEA-GS-M8	Solder lugs
					3 SEA-3GS-M8-S	Screw terminals
					4 KM8-M8-GSGD-... (pre-assembled connecting cable)	Socket, M8, 3-pin
					4 NEBU-...-M8G3 (modular system for choice of connecting cables)	Socket, M5, 3-pin
						Socket, M8, 3-pin
Socket, M8, 4-pin						
Socket, M12, 5-pin						
Open cable end						

Terminal CPX-P

Key features – Electrical components

Electrical connection – Connection block with M12, 4-pin connection

CPX-P-AB-4XM12-4POL-8DE-N-IS

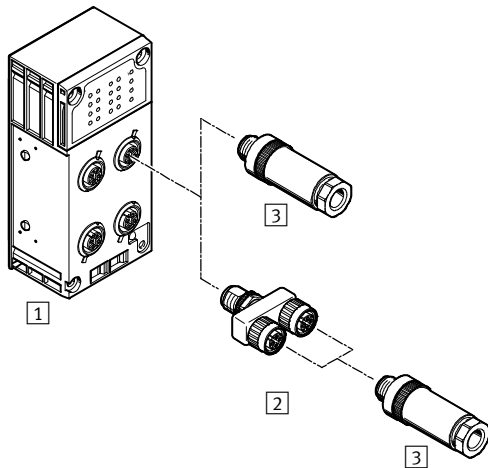

- Pre-assembled and sturdy with 2 channels per connection
- 4 sockets
- 4-pin design per socket
- With two channels per connection, the corresponding input signals can be easily connected via a T-adapter

Combination of connection block and electrical connection technology

Connection block	Connection technology	Plug connector/ connecting cable	Selectable connection technology	Plug connector/ connecting cable	Selectable connection technology
1 CPX-P-AB-4XM12-4POL-8DE-N-IS	Socket, M12, 4-pin	3 NECU-M-S-A12G4-IS	Plug, M12, 4-pin	-	-
		3 NECU-S-M12G4-...-IS	Plug, M12, 4-pin	-	-
		2 NEDU-M12D4-M12T4 (T-adapter)	1x plug M12, 4-pin to 2x socket M12, 4-pin	3 NECU-S-M12G4-...-IS	Plug, M12, 4-pin

Terminal CPX-P

Key features – Electrical components

Electrical connection – Connection block with M12, 5-pin connection

CPX-AB-4-M12x2-5POL and CPX-AB-4-M12x2-5POL-R, plastic design

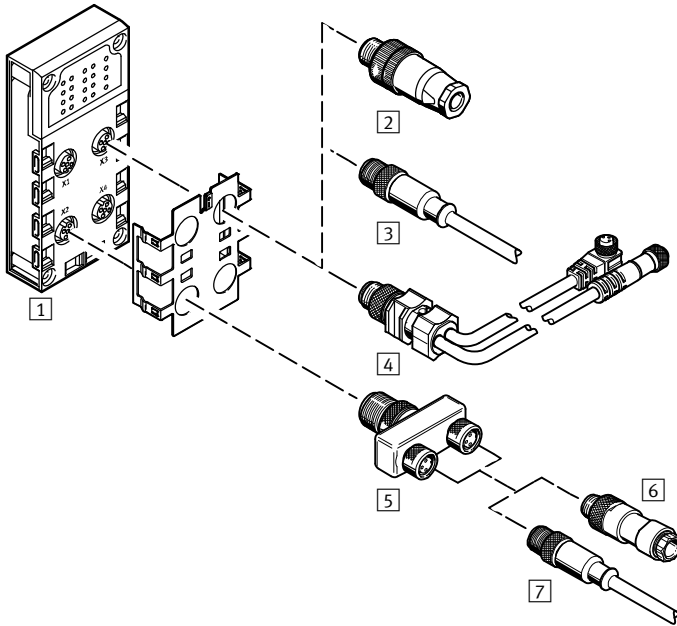

- Pre-assembled and sturdy with 2 channels per connection
- 4 sockets
- 5-pin design per connection
- Version ...-R with quick lock technology and metal thread for screening
- With two channels per connection, the corresponding input signals can be easily connected via a T-adapter and conventional cable with M8 connection

CPX-M-AB-4-M12X2-5POL, metal design

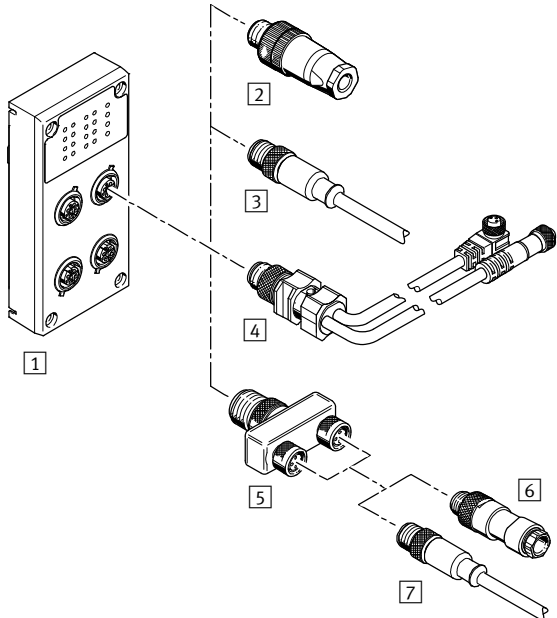

- Pre-assembled and sturdy with 2 channels per connection
- 4 sockets
- 5-pin design per connection
- With two channels per connection, the corresponding input signals can be easily connected via a T-adapter and conventional cable with M8 connection

Terminal CPX-P

Key features – Electrical components

Combination of connection block and electrical connection technology										
Connection block	Connection technology	Plug connector/connecting cable	Connection technology	Plug connector/connecting cable	Connection technology					
1 CPX-AB-4-M12x2-5POL CPX-AB-4-M12x2-5POL-R	Socket, M12, 5-pin	2 SEA-GS-7	Screw terminals	-	-					
		2 SEA-4GS-7-2,5	Screw terminals	-	-					
		2 SEA-GS-9	Screw terminals	-	-					
		2 SEA-M12-5GS-PG7	Screw terminals	-	-					
		2 SEA-GS-11-DUO	Screw terminals, for two cables	-	-					
		2 SEA-5GS-11-DUO	Screw terminals, for two cables	-	-					
		3 KM12-M12-... (pre-assembled connecting cable)	Socket, M12, 4-pin	-	-					
		3 NEBU-...-M12G4	Socket, M5, 4-pin	-	-					
		3 NEBU-...-M12G5	Socket, M8, 4-pin	-	-					
			Socket, M12, 5-pin	-	-					
			Open cable end	-	-					
		4 KM12-DUO-M8-... (pre-assembled connecting cable)	Plug M12, 4-pin to 2x socket M8, 3-pin	6 SEA-GS-M8	Solder lugs					
		5 NEDU-M8D3-M12T4 (T-adapter)		6 SEA-3GS-M8-S	Screw terminals					
		5 NEDU-M12D5-M12T4 (T-adapter)				7 KM8-M8-GSGD-... (pre-assembled connecting cable)	Socket, M8, 3-pin			
						7 NEBU-...-M8G3 (modular system for choice of connecting cables)	Socket, M5, 3-pin			
							Socket, M8, 3-pin			
							Socket, M8, 4-pin			
							Socket, M12, 5-pin			
										Open cable end
						6 SEA-GS-7	Screw terminals			
						6 SEA-4GS-7-2,5	Screw terminals			
						6 SEA-GS-9	Screw terminals			
						6 SEA-M12-5GS-PG7	Screw terminals			
						6 SEA-GS-11-DUO	Screw terminals, for two cables			
						6 SEA-5GS-11-DUO	Screw terminals, for two cables			
		7 KM12-M12-... (pre-assembled connecting cable)	Socket, M12, 4-pin							
		7 NEBU-...-M12G4 (modular system for choice of connecting cables)	Socket, M5, 4-pin							
7 NEBU-...-M12G5 (modular system for choice of connecting cables)	Socket, M8, 4-pin									
	Socket, M12, 5-pin									
	Open cable end									

Terminal CPX-P

Key features – Electrical components

Electrical connection – Connection block with spring-loaded terminal connection

CPX-AB-8-KL-4POL

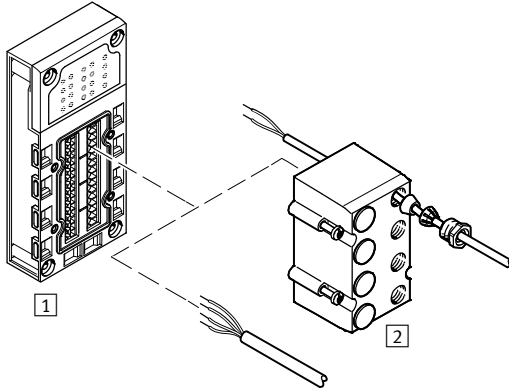

- Quick connection technology for use in control cabinets
- 32 spring-loaded terminals
- 4 spring-loaded terminals per channel
- Wire cross sections 0.05 ... 1.5 mm²
- Optional cover with fittings for IP65/67 connection
 - 8 through-holes M9
 - 1 through-hole M16
 - Blanking plug
 - For I/O distributors, consoles or individual sensors/actuators

Combination of connection block and electrical connection technology

Connection block	Connection technology	Plug connector/connecting cable	Selectable connection technology
1] CPX-AB-8-KL-4POL	Spring-loaded terminals, 32-pin	2] AK-8KL (cover)	–

Electrical connection – Connection block with clamping connector

CPX-P-AB-2XKL-8POL and CPX-P-AB-2XKL-8POL-8DE-N-IS

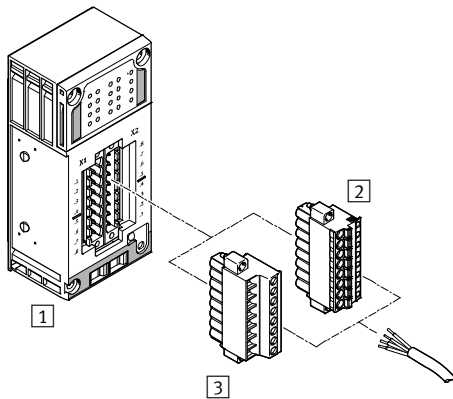

- Quick connection technology for use in control cabinets
- Spring-loaded terminals or screw terminals
- Wire cross sections 0.2 ... 2.5 mm²

Combination of connection block and electrical connection technology

Connection block	Connection technology	Plug connector/connecting cable	Selectable connection technology
1] CPX-P-AB-2XKL-8POL	Plug, 8-pin	2] NECU-L3G8-C1	Spring-loaded terminals
		3] NECU-L3G8-C2	Screw terminals
1] CPX-P-AB-2XKL-8POL-8DE-N-IS	Plug, 8-pin	2] NECU-L3G8-C1-IS	Spring-loaded terminals
		3] NECU-L3G8-C2-IS	Screw terminals

Terminal CPX-P

Key features – Electrical components

Electrical connection – Connection block with Sub-D connection

CPX-AB-1-SUB-BU-25POL

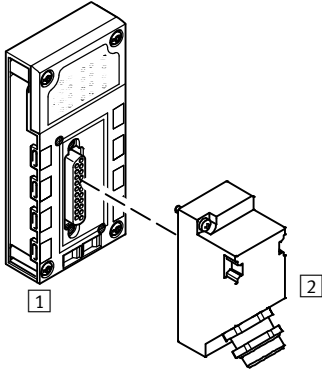

- Multi-pin plug connection for I/O distributor or console
- One socket, Sub-D
- 25-pin design

Combination of connection block and electrical connection technology

Connection block	Connection technology	Plug connector/connecting cable	Selectable connection technology
1 CPX-AB-1-SUB-BU-25POL	Socket, Sub-D, 25-pin	2 SD-SUB-D-ST25	Crimp contacts

Electrical connection – Connection block with quick connector

CPX-AB-4-HAR-4POL

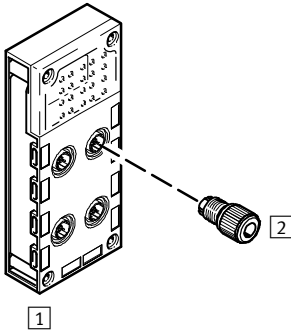

- Sturdy quick connection technology for individual connections
- 4 sockets
- 4-pin design per socket

Combination of connection block and electrical connection technology

Connection block	Connection technology	Plug connector/connecting cable	Selectable connection technology
1 CPX-AB-4-HAR-4POL	Socket, quick connection, 4-pin	2 SEA-GS-HAR-4POL	Insulation displacement connectors

Terminal CPX-P

Key features – Assembly

Hood
Description → 98

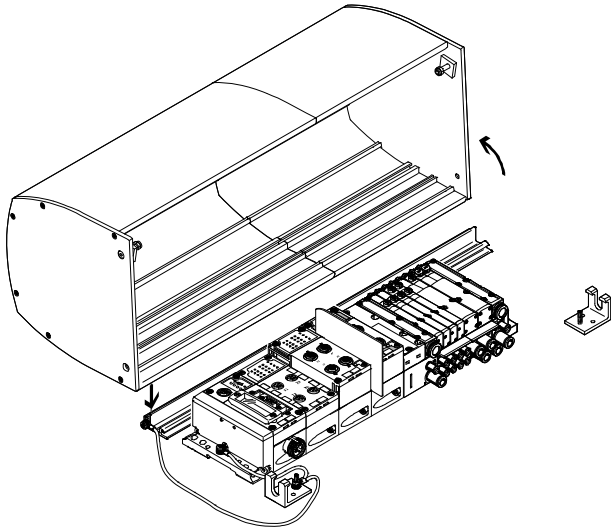

The CPX hood CAFC is a space and cost-saving alternative to a control cabinet. It is designed as an extruded aluminium profile and is installed on a mounting plate. The valve terminal is well protected and is quick to install without the need for complex control cabinet installation for cables and tubing.

The rail and the two mounting brackets are mounted on a back plate. The hood is attached to the retaining rail and secured with two screws. There is also a stand-by position (locking of the hood in the open position). The hood is locked using two side screws (which meet the requirements for a special lock in compliance with ATEX). The CPX hood can be ordered online using the valve terminal configurator.

Advantages of the CPX hood

- Impact protection (min. 7 J) for the underlying modules in combination with a suitable mounting plate provided by the user
- Protection against electrostatic discharge through the use of electrically conductive materials and the option of connecting an earth wire
- Protection against disconnection of live plug connectors (by securing the hood with at least one special lock to EN 600079-0, 9.2 and 20)
- UV protection for the underlying CPX-P and MPA modules

Points to note when using the CPX hood

- CPX-P power supply via angled plugs, no T-plugs
- Electrical supply plate/additional power supply only possible with angled plug
- No MPA vertical stacking
- Use of larger QS fittings (for tubing O.D. larger than 12 mm) only possible with the angled design
- Ducted exhaust air only with elbow connector
- The permissible ambient temperature of the valve terminal is reduced by 5 °C

Note

The CPX hood has no influence on the ATEX classification of the valve terminal or of the CPX terminal.

The CPX hood has no influence on the IP protection class of the valve terminal or of the CPX terminal.

The CPX hood does not protect against the effects of the weather in installations that are not in closed spaces.

Terminal CPX-P

Key features – Assembly

Hood Assembly

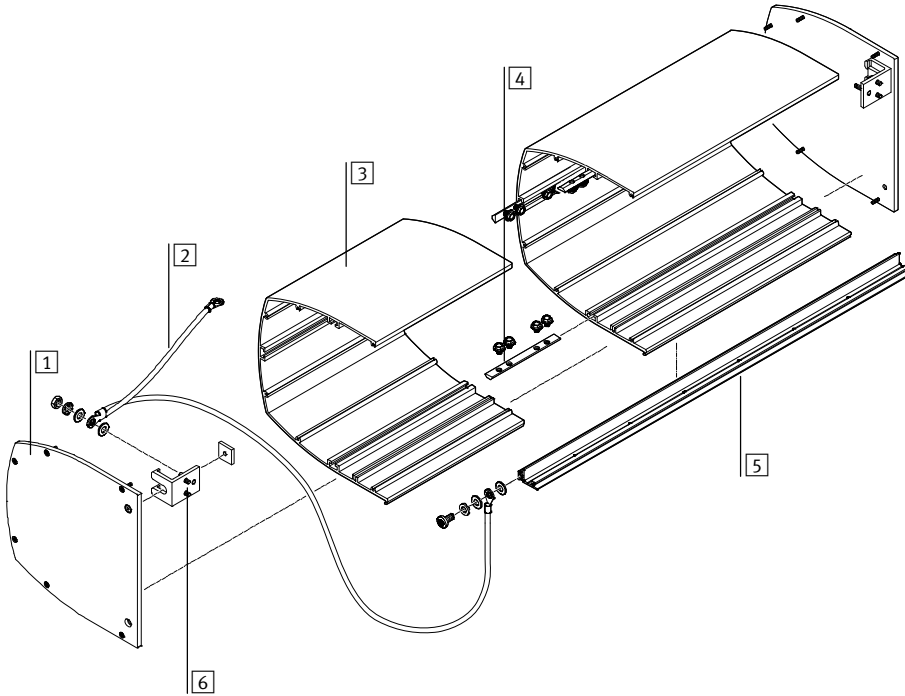

Procedure:

- Assemble the rail and mounting bracket included in the mounting kit
- Attach the earth cable
- Assemble the hood (if applicable, screw together several hood sections before attaching the side pieces)
- Attach and secure the hood

- 1 Side piece
- 2 Earth cable
- 3 Hood section
- 4 Slot nut with screws, for joining the hood sections
- 5 Rail
- 6 Mounting bracket

Technical data

Weight:

- Hood: approx. 500 g per 100 mm of length

- Mounting rail: approx. 550 g per 1,000 mm of length
- Side pieces: approx. 500 g per side

- Ambient temperature $-5 \dots +50 \text{ } ^\circ\text{C}$

- RoHS-compliant

Plug coding

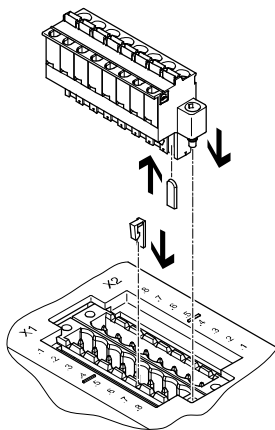

The connection blocks CPX-P-AB-2XKL-8POL, CPX-P-AB-2XKL-8POL-8DE-N-IS and the sockets NECU-L3G8 can be matched to one another using the coding elements CPX-P-KDS-AB-2XKL.

This reduces the likelihood of a socket being inserted in the wrong slot after it is removed from the CPX-P terminal (protection against incorrect insertion).

Terminal CPX-P

Key features – Assembly

Mounting options

Valve terminals with CPX-P terminal support different mounting options for direct machine mounting with high protection and control cabinet installation.

H-rail mounting

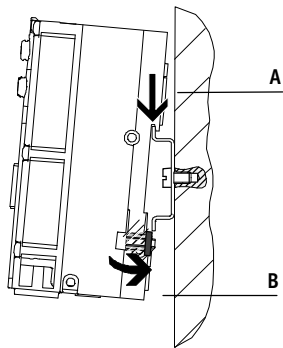

The rear profile of the CPX-P interlinking block has a preformed H-rail mounting so that the CPX-P terminal can be attached to the H-rail using the H-rail mounting kit. The CPX-P terminal is mounted on the H-rail (see arrow A) and

then swivelled onto the H-rail and secured in place with the clamping component (see arrow B). The optional earthing plate enables a connection to be established to the machine potential/earth in one easy step.

For H-rail mounting you will need the following mounting kit:

- CPX-CPA-BG-NRH

This facilitates mounting of the CPX-P terminal on H-rails to EN 60715. An additional mounting kit is required for combination with valve terminals.

Wall mounting

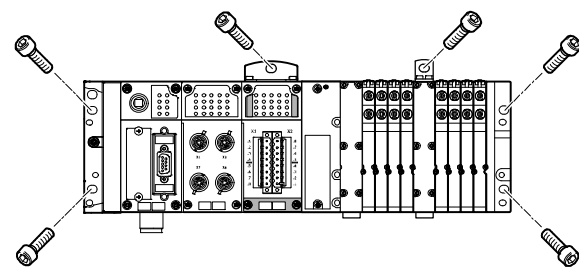

The end plates of the CPX-P terminal, the valve terminal and the pneumatic interface include mounting holes for wall mounting. Additional mountings for the CPX-P terminal are available for longer valve terminals.

Additional mounting components

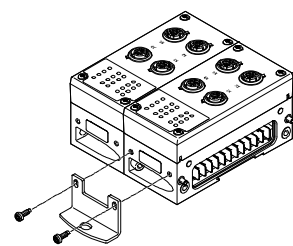

Additional mounting brackets for the CPX-P terminal that can be screwed onto the interlinking blocks are available for longer valve terminals.

 Note

For CPX-P terminals with 4 or more interlinking blocks: you will require additional mounting brackets of the type CPX-M-BG-RW approx. every 100 or 150 mm. These are supplied pre-assembled.

Linking with screws

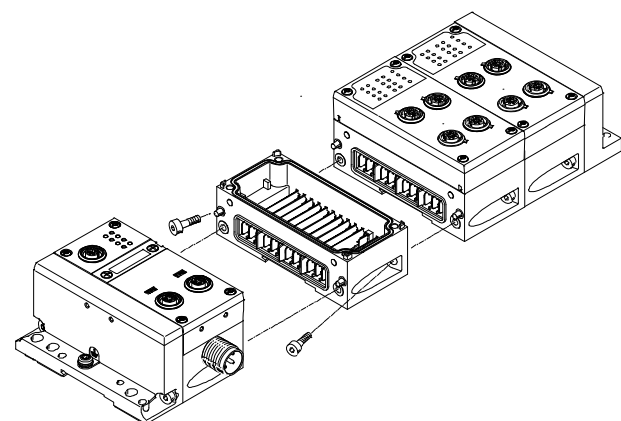

The mechanical connection between the CPX-P modules is created using special angle fittings. The CPX-P terminal can thus be expanded at any time.

Terminal CPX-P

Key features – Power supply

Power supply concept

General information

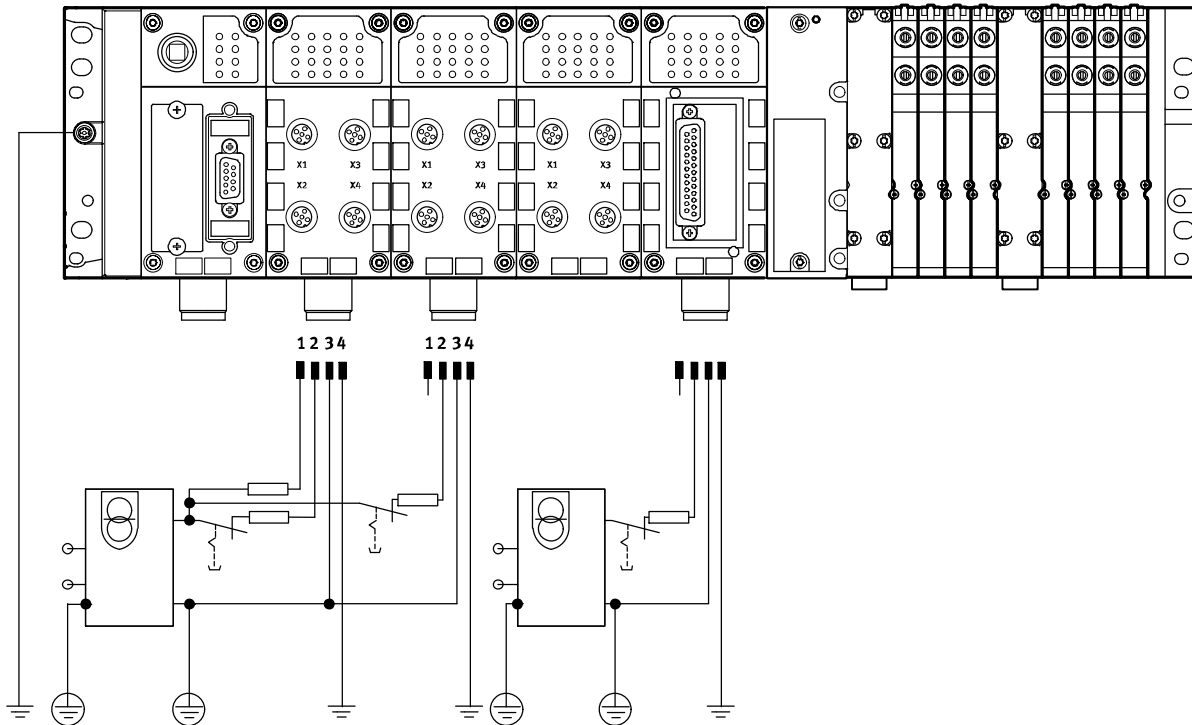

The use of decentralised devices on the fieldbus – particularly with high protection for direct machine mounting – demands a flexible power supply

concept. A valve terminal with CPX-P can, in principle, supply all voltages via a single connection.

A distinction is made between supply for

- electronics plus sensors
- valves plus actuators.

Connection technology:

- 7/8"

Interlinking blocks

Interlinking blocks represent the backbone of the CPX-P terminal with all supply lines. They provide the power supply for the modules used on

them as well as their bus connections. Many applications require the CPX-P terminal to be segmented into voltage zones. This applies in particular to the

separate disconnection of the outputs. The interlinking blocks provide either a space-saving central power supply for the entire CPX-P terminal or

galvanically isolated, all-pin disconnectable potential groups/voltage segments.

Terminal CPX-P

Key features – Power supply

Interlinking blocks

With system supply

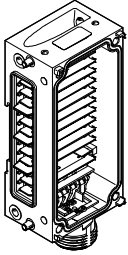

- CPX-M-GE-EV-S-7/8-5POL
- CPX-M-GE-EV-S-7/8-5POL-VL

Connection technology

- 7/8", 5-pin

- For CPX-P terminal modules and connected sensors
- For valves that are connected to the CPX-P terminal via a pneumatic interface

- For actuators that are connected to output modules of the CPX-P terminal

Without power supply

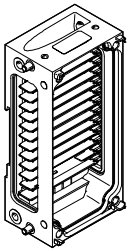

- CPX-M-GE-EV

With additional power supply for outputs

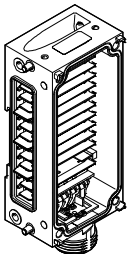

- CPX-M-GE-EV-Z-7/8-5POL
- CPX-M-GE-EV-Z-7/8-5POL-VL

Connection technology

- 7/8", 5-pin

- For actuators that are connected to output modules of the CPX-P terminal

-  - Note

For 7/8":

- Commercially available accessories are often limited to max. 8 A

-  - Note

Valve terminal MPA-S has either a 5-pin 7/8", 4-pin 7/8" or 3-pin M18 power supply for one or more valve voltage zones. Galvanically isolated,

all pins disconnectable with voltage monitoring in the following MPA module.

Terminal CPX-P

Key features – Diagnostics

Diagnostics

System performance

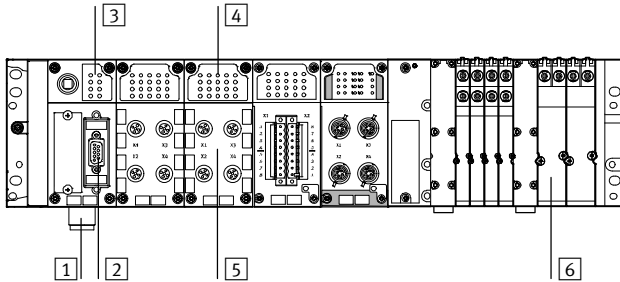

- 1 Undervoltage monitoring
- 2 Diagnostics via bus interface
- 3 Diagnostic overview LED
 - Fieldbus status
 - CPX-P status
- 4 Status and diagnostic LED for module and I/O channels
- 5 Module and channel-specific diagnostics
- 6 Valve-specific diagnostic module and solenoid coils

Detailed diagnostic functions are needed in order to quickly locate the causes of errors in the electrical installation and therefore reduce downtimes in production plants. A basic distinction is made between on-the-spot diagnostics using LEDs or an operator unit (CPX-MMI) and diagnostics using a bus interface.

The CPX-P terminal supports on-the-spot diagnostics via a row of LEDs. This is separate from the connection area and therefore provides good visual access to status and diagnostic information.

Module and channel-specific diagnosis is supported, for example

- Undervoltage detection for outputs and valves
- Short circuit detection for sensors, outputs and valves
- Open-load detection for a missing solenoid coil
- Storage of the last 40 causes of errors with error start and error end

The diagnostic messages can be read out via the bus interface in the higher-order controller and visualised for the central recording and evaluation of error causes. This is done using the individual fieldbus-specific channels. The CPX-FEC also offers the option of access via the integrated Ethernet interface (remote maintenance via PC/web applications).

Overview of LEDs on the bus node

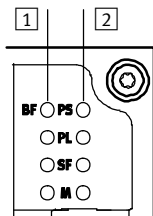

- 1 Fieldbus-specific LEDs
 - On each bus node, a maximum of 4 fieldbus-specific LEDs display the fieldbus communication status of the CPX-P terminal with the higher-order controller.
- 2 CPX-P-specific LEDs
 - A further 4 CPX-P-specific LEDs provide non-fieldbus-specific information about the status of the CPX-P terminal, for example
 - Power system
 - Power load
 - System fault
 - Modification parameters

Input/output module status and diagnostic LEDs

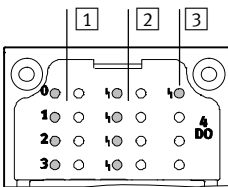

- 1 Status LEDs for the inputs and outputs
 - Each input and output channel is assigned a status LED.
- 2 Channel-oriented diagnostic LEDs
 - Depending on the module design, another diagnostic LED is available for each I/O channel.
- 3 Group diagnostic LEDs
 - An LED displays the group diagnostics for each module.

Terminal CPX-P

Key features – Parameterisation

Diagnostics

Display on the operator unit (CPX-MMI)

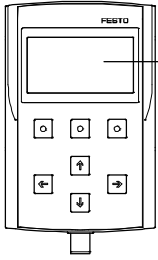

- 1 LCD graphical display for on-site plain-text diagnostics
 - Fault location and type
 - Without programming

Display on a PC

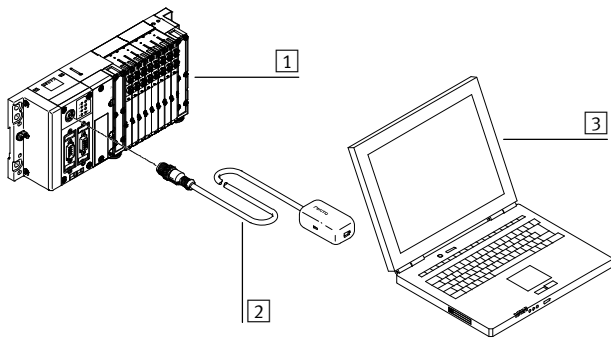

- 1 CPX-P terminal with valve terminal
 - 2 Adapter diagnostic interface to USB
 - 3 Laptop/portable device with USB interface and installed CPX-P
- Maintenance Tool (CPX-FMT) software
- Fault location and type
 - Without programming
 - Storing the configuration
 - Preparing screenshots

Parameterisation

Changes to the application are often required during commissioning. The parameterisable characteristics of the CPX-P modules mean that functions can be very easily changed by means of configuration software. This reduces

the number of modules needed and, consequently, the amount of storage space required.

It is therefore possible, for example, to reduce the input debounce time for an input module – normally 3 ms – to

0.1 ms on a "fast" input module for faster processes, or to set the response of a valve following a fieldbus interrupt.

Depending on the modules used, parameterisation can be performed

via the following interfaces:

- Ethernet
- Fieldbus
- Control block direct interface (programming interface)
- Operator unit CPX-MMI

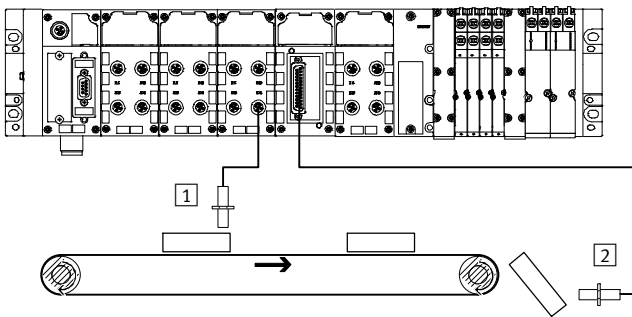

- 1 Input debounce time 3 ms
- 2 Input debounce time 0.1 ms

Terminal CPX-P

Key features – Addressing

Addressing

The various CPX-P modules occupy a different number of I/O addresses within the CPX-P system. The maximum address space for bus nodes depends on the performance of the fieldbus systems.

Maximum system configuration:

- 1 bus node or control block
- 9 I/O modules
- 1 pneumatic interface (e.g. pneumatic interface MPA-S with up to 16 MPA manifold sub-bases)

The maximum system configuration can be limited in individual cases by exceeding the address space.



Note

Please refer to the detailed description of the configuration/addressing rules in the technical data for CPX bus nodes.

Overview – Allocated addresses for CPX-P modules

	Inputs [bit]	Outputs [bit]
CPX-P-8DE-N	16	8
CPX-P-8DE-N (inputs configured as counter)	80	16
CPX-P-8DE-N-IS	16	8
CPX-P-8DE-N-IS (inputs configured as counter)	80	16
CPX-16DE	16	–
CPX-4DA	–	4
CPX-8DA	–	8
CPX-4AE-U-I	4 x 16	–
CPX-2AA-U-I	–	2 x 16
VMPA1-FB-EMS-8	–	8
VMPA1-FB-EMG-8	–	8
VMPA2-FB-EMS-4	–	4
VMPA2-FB-EMG-4	–	4
VMPA1-FB-EMS-D2-8	–	8
VMPA1-FB-EMG-D2-8	–	8
VMPA2-FB-EMS-D2-4	–	4
VMPA2-FB-EMG-D2-4	–	4
VMPA-FB-PS-1	16	–
VMPA-FB-PS-3/5	16	–
VMPA-FB-PS-P1	16	–
VMPA-FB-EMG-P1	16	16

Overview – Address space for CPX bus node and control block

	Protocol	Max. total		Max. digital		Max. analogue	
		Inputs	Outputs	Inputs	Outputs	Inputs	Outputs
CPX-FEC	<ul style="list-style-type: none"> • EasyIP • Modbus TCP 	512 bits	512 bits	512 DI	512 DO	32 AI	18 AO
CPX-FB11	DeviceNet	512 bits	512 bits	512 DI	512 DO	32 AI	18 AO
CPX-FB13	PROFIBUS	512 bits	512 bits	512 DI	512 DO	32 AI	18 AO
CPX-FB32	EtherNet/IP	512 bits	512 bits	512 DI	512 DO	32 AI	18 AO
CPX-FB33	PROFINET RT	512 bits	512 bits	512 DI	512 DO	32 AI	18 AO

Note

The bandwidth of the bus nodes can be restricted by the choice of module and the maximum number of modules.

Terminal CPX-P

Technical data



-  - Module width
50 mm



-  - Note
The data given here apply to the CPX-P system. If components that conform to lower values are used in the system, the specification for the entire system is reduced to the values of those components.

Example
Protection class IP65 applies only to the fully assembled system with fitted plugs or covers (which must also conform to IP65). If components with a lower protection class are used, the

protection level of the entire system is reduced to the protection class of the component with the lowest protection level, for example CageClamp connection block with IP20 protection.

General technical data		
Module No.		562818
Max. no. of modules ¹⁾	Control block	1
	Bus node	1
	I/O modules	9
	Pneumatic interface	1
Max. address capacity	Inputs [byte]	64
	Outputs [byte]	64
Internal cycle time	[ms]	< 1
Configuration support		Fieldbus-specific
LED displays	Bus node/control block	Up to 4 LEDs, bus-specific 4 LEDs, CPX-P-specific • PS = Power system • PL = Power load • SF = System fault • M = Modify parameter/forcing active
	I/O modules	Min. one group diagnostic LED Channel-oriented status and diagnostic LED, depending on module
	Pneumatic interface	One group diagnostic LED Valve status LED on valve
Diagnostics		<ul style="list-style-type: none"> • Channel and module-oriented diagnostics for inputs/outputs and valves • Detection of module undervoltage for the different potential values • Storage of the last 40 errors with timestamp (acyclic access)

1) A maximum of 11 modules in total can be combined.
(e.g. 1 control block + 9 I/O modules + 1 pneumatic interface, or 1 control block + 1 bus node + 8 I/O modules + 1 pneumatic interface)

Terminal CPX-P

Technical data

FESTO

General technical data		
Module No.		562818
Parameterisation		Module-specific and entire system, for example: <ul style="list-style-type: none"> • Diagnostic behaviour • Condition monitoring • Profile of inputs • Fail-safe response of outputs and valves
Commissioning support		Forcing of inputs and outputs
Nominal operating voltage	[V DC]	24
Operating voltage range	[V DC]	18 ... 30
Power supply	Interlinking block with system supply for electronics plus sensors	[A] 8
	actuators plus valves	[A] 8
	Additional power supply for actuators	[A] 8
Current consumption		Depending on system configuration
Power failure bridging (bus electronics only)	[ms]	10
Power supply connection		7/8", 5-pin
Fuse concept		Per module with electronic fuses
Tests	Vibration test to DIN IEC 68	<ul style="list-style-type: none"> • With wall mounting: Severity level 2 • With H-rail mounting: Severity level 1
	Shock test to DIN IEC 68	<ul style="list-style-type: none"> • With wall mounting: Severity level 2 • With H-rail mounting: Severity level 1
PWIS classification		PWIS-free (free of paint-wetting impairment substances)
Interference immunity		EN 61000-6-2 (industry)
Interference emission		EN 61000-6-4 (industry)
Isolation test for galvanically isolated circuits to IEC 1131 Part 2	[V DC]	500
Galvanic isolation of electrical voltages	[V DC]	80
Protection against direct and indirect contact		PELV (Protective Extra-Low Voltage)
Materials		End plates: Die-cast aluminium
Grid dimension	[mm]	50

Operating and environmental conditions		
Module No.		562818
Ambient temperature	[°C]	-5 ... +50
Storage temperature	[°C]	-20 ... +70

Terminal CPX-P

Technical data

FESTO

Certifications and approvals – Maximum values	
Module No.	562818
ATEX category for gas	II 3G
Explosion ignition protection type for gas	Ex nA IIC T4 X Gc
Explosion-proof temperature rating [°C]	-5 ≤ Ta ≤ +50
CE marking (see declaration of conformity)	To EU Explosion Protection Directive (ATEX)
	To EU EMC Directive ¹⁾
Protection class to EN 60529	IP20, IP65
Certification	cULus recognized (OL)
	C-Tick
Explosion protection certification outside the EU	EPL Gc (Ru)

- 1) For information about the applicability of the component see the manufacturer's EC declaration of conformity at: www.festo.com/sp → User documentation.
If the component is subject to restrictions on usage in residential, office or commercial environments or small businesses, further measures to reduce the emitted interference may be necessary.

 Note

The values indicated represent the maximum performance limits that can be achieved with the fully assembled product. Depending on the individual components used, the value actually achieved for the overall product may be lower.



You can select e.g. the individual components required to achieve the ATEX category by choosing the corresponding features in the online product configurator:
→ Internet:cpx-p

Weight [g]					
Control block	FEC	140.0	Pneumatic interface	MPA-S	238.4
Bus node	FB11	120.0	Connection block	Metal	175.0
	FB13	115.0	Interlinking block, metal	Without power supply	162.0
	FB32	125.0		System supply, 7/8", 5-pin	187.0
	FB33	280.0	End plate for metal design	Left-hand	113.0
I/O module	CPX	38.0		Right-hand	113.0
	NAMUR	100.0			

Terminal CPX-P

Accessories

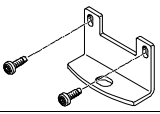
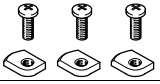
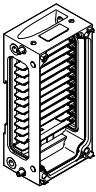
FESTO

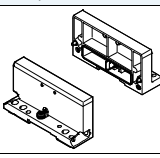
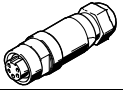
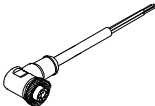
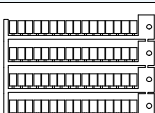
Ordering data – Accessories			
Designation		Part No.	Type
Mounting			
	Attachment for wall mounting (for long valve terminals, 2 mounting brackets and 4 screws)	550217	CPX-M-BG-RW-2x
	Mounting for H-rail	526032	CPX-CPA-BG-NRH
Interlinking block			
	Without power supply	–	550206 CPX-M-GE-EV
	With system supply	7/8" – 5-pin	550208 CPX-M-GE-EV-S-7/8-5POL
		7/8" – 5-pin, for ATEX environment	8022165 CPX-M-GE-EV-S-7/8-5POL-VL
	With additional power supply for outputs	7/8" – 5-pin	550210 CPX-M-GE-EV-Z-7/8-5POL
7/8" – 5-pin, for ATEX environment		8022158 CPX-M-GE-EV-Z-7/8-5POL-VL	
Mounting accessories			
	Screws for mounting the bus node/ connection block on an interlinking block	Bus node/plastic connection block	550219 CPX-M-M3x22-4x
		Bus node/metal connection block	550216 CPX-M-M3x22-S-4x
End plates			
	End plate	Right-hand	550214 CPX-M-EPR-EV
		Left-hand	550212 CPX-M-EPL-EV
Power supply			
	Plug socket for mains connection 7/8", straight, 5-pin	0.25 ... 2.0 mm ²	543107 NECU-G78G5-C2
	Plug socket for mains connection 7/8", angled, 5-pin – open cable end, 5-pin	2 m	573855 NEBU-G78W5-K-2-N-LE5
Inscription labels			
	Inscription labels 6x10 mm, 64 pieces, in frames	18576	IBS-6x10

Terminal CPX-P

Accessories

FESTO

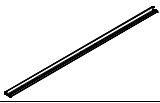
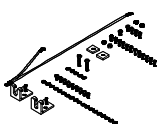
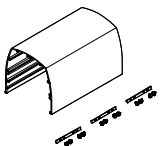
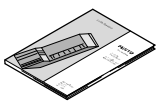
Ordering data – Accessories				
Designation			Part No.	Type
Hood				
	Mounting rail for securing the hood	1,000 mm	572256	CAFC-X1-S
	Mounting kit for CPX hood		572257	CAFC-X1-BE
	Hood section for CPX-P terminal including mounting attachments for connecting several hood sections in series	200 mm	572258	CAFC-X1-GAL-200
		300 mm	572259	CAFC-X1-GAL-300
User documentation				
	CPX-P System Manual	German	526445	P.BE-CPX-SYS-DE
		English	526446	P.BE-CPX-SYS-EN
		Spanish	526447	P.BE-CPX-SYS-ES
		French	526448	P.BE-CPX-SYS-FR
		Italian	526449	P.BE-CPX-SYS-IT
		Swedish	526450	P.BE-CPX-SYS-SV
	Operator unit CPX-MMI-1	German	534824	P.BE-CPX-MMI-1-DE
		English	534825	P.BE-CPX-MMI-1-EN
		French	534827	P.BE-CPX-MMI-1-FR
		Italian	534828	P.BE-CPX-MMI-1-IT
		Swedish	534829	P.BE-CPX-MMI-1-SV
		Spanish	534826	P.BE-CPX-MMI-1-ES

Terminal CPX-P

Accessories



User documentation

Comprehensive user manuals are vital for the fast and reliable use of fieldbus components.

The manuals provided by Festo contain step-by-step instructions for using the CPX-P terminal:

1. Installation
2. Commissioning and parameterisation
3. Diagnostics

Application-oriented explanations are provided for integration of the CPX-P terminal in the programming and configuration software of the various controller manufacturers.

Use the order code to select the language you want.

The manual for the configuration you have ordered is supplied automatically.

Device description files and icons are used to explain the integration of the CPX-P terminal in the configuration software of the various controller manufacturers.

The documents can be downloaded quickly and easily from the Festo website.

→ www.festo.com

Overview – User documentation

Type	Title	Description
Pneumatic components		
P.BE-MPA-...	Valve terminals with MPA-S pneumatics	Instructions on assembly, installation, commissioning and diagnostics of the MPA-S pneumatic components.
Electronic components		
P.BE-CPX-SYS-...	System description, installation and commissioning	Overview of the design, components and mode of operation of the CPX-P terminal; installation and commissioning instructions as well as basic principles of parameterisation.
P.BE-CPX-EA-...	CPX-P-EA modules, digital	Connection technology and assembly, installation and commissioning instructions for digital input and output modules of the type CPX-... as well as the CPA, MIDI/MAXI, VTSA/VTSA-F and MPA-S/F/L pneumatic interface.
P.BE-CPX-P-EA-...	CPX-P-EA modules, NAMUR sensors	Connection technology and assembly, installation and commissioning instructions for digital input and output modules of the type CPX-P-....
P.BE-CPX-AX-...	CPX-P-EA modules, analogue	Connection technology and assembly, installation and commissioning instructions for analogue input and output modules of the type CPX-...
P.BE-CPX-FB...	CPX bus node	Instructions on assembly, installation, commissioning and diagnostics of the relevant bus node.
P.BE-CPX-PNIO...	CPX bus node for PROFINET	Instructions on assembly, installation, commissioning and diagnostics of the relevant bus node.
P.BE-CPX-FEC...	CPX control block	Instructions on assembly, installation, commissioning and diagnostics of the relevant control block.
P.BE-CPX-MMI-1-...	Universal handheld type CPX-MMI-1	Instructions on assembly, installation, commissioning and diagnostics of the CPX operator unit.

Terminal CPX-P

Technical data – Operator unit CPX-MMI-1

FESTO

-  - Width
81 mm

The operator unit is a small, convenient commissioning and service device for the CPX-P terminal. It provides data polling, configuration and diagnostic functions for CPX-P terminals. Its extremely flexible application range means that data can be read in or out at any location. IP65 compatibility makes it suitable for use in harsh industrial environments.



Application

Functions

- Advance commissioning through the monitoring/forcing of inputs and outputs without fieldbus master/PLC
- Test function for parameter settings, for example fail-safe of the outputs or switch-on delay of the inputs
- Plain-text diagnostics of module and channel-oriented errors
- Condition monitoring: preselection/loading of counters, activation of the channels to be monitored
- Display of the last 40 error occurrences with timestamp
- Identification of sporadic causes of errors through display of the diagnostic history
- Password protection

Connection

The operator unit is connected to the CPX bus nodes or control block, as appropriate, using a pre-assembled M12 cable.

The voltage for the operator unit is supplied by the CPX-P component

Communication

Once connected to the CPX-P terminal, the operator unit loads the available configuration for the I/O modules, valves, etc.

This ensures the availability of up-to-date texts, messages, menus and displays.

Status information, diagnostic messages and parameter bits are then exchanged during operation.

Assembly

A mounting bracket for the operator unit offers the option of wall or H-rail mounting.

The mounting bracket also has an option for temporary mounting using a hanging device.

Terminal CPX-P

Technical data – Operator unit CPX-MMI-1

Connection

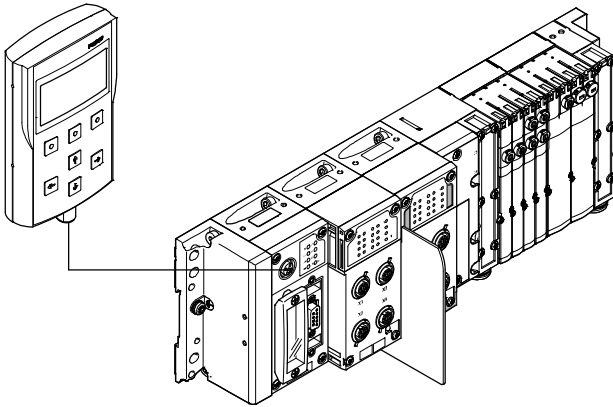

The operator unit is connected to the CPX-P terminal using pre-assembled cables.

Function examples

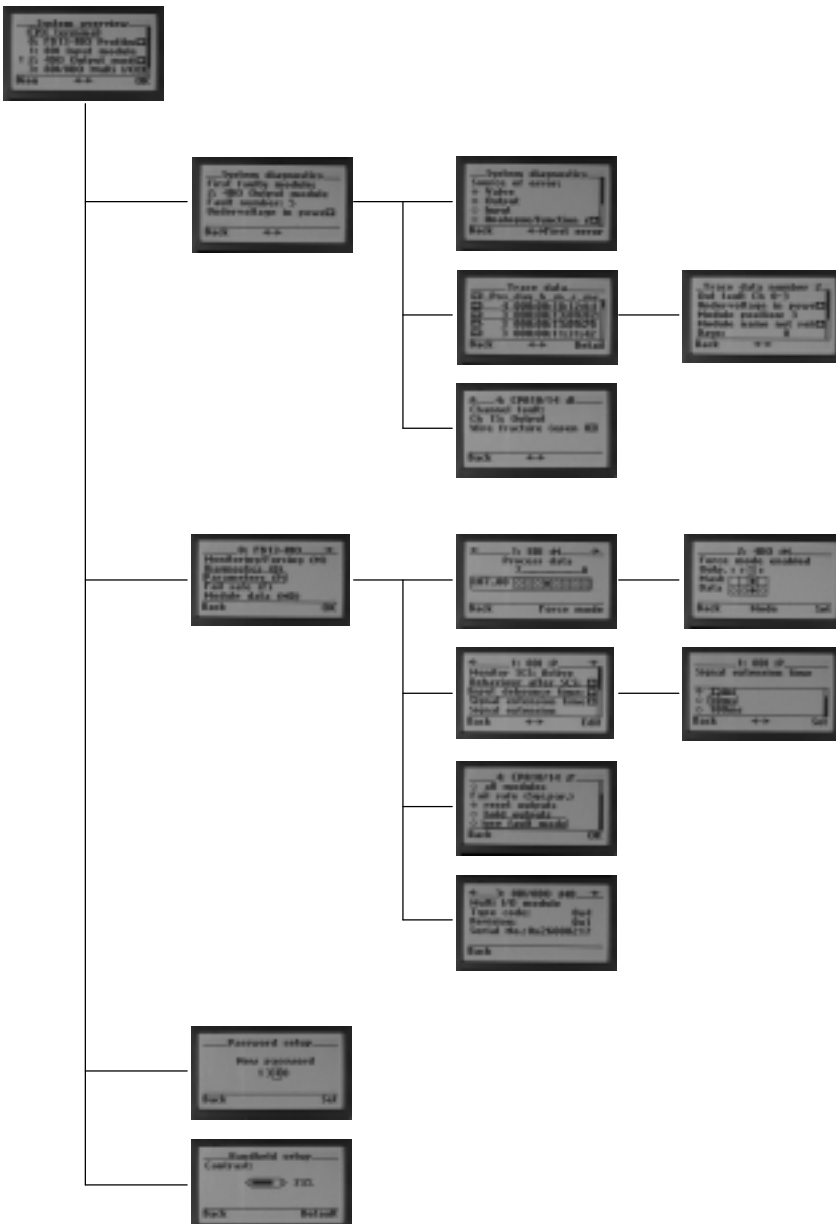

System overview

- Overview of configured modules and current diagnostic messages

Diagnostics

- Fast access to the diagnostic history and the modules with diagnostic messaging
- Display of the last 40 diagnostic messages with timestamp
- Display of the current diagnostic message for a module

Commissioning

- Selection of module-specific data and parameters
- Display and modification of the current status of the inputs and outputs of a module
- Display and modification of the current settings for module-specific parameters

Setup

- Setting of access permission (password)
- Contrast setting of the display

Terminal CPX-P

Technical data – Operator unit CPX-MMI-1

General technical data		
Type	CPX-MMI-1	
Data interface	RS232 interface, 57.6 kBaud, M12 socket, 4-pin	
Display component	LCD graphical display with background illumination (128 x 64 pixels)	
Control elements	7 keys: 4 arrow keys and 3 function keys, touch-sensitive keypad	
Electromagnetic compatibility	Interference emission tested to DIN EN 61000-6-4, industry	
	Interference immunity tested to DIN EN 61000-6-2, industry	
Nominal operating voltage	[V DC]	24, supplied by the connected device
Operating voltage range	[V DC]	18 ... 30
Current consumption	[mA]	50 ... 60
Protection class to IEC 60529	IP65	
Relative air humidity	[%]	90, non-condensing
Vibration resistance	Tested to DIN/IEC 68/EN 60068, Part 2-6 • With wall mounting: Severity level 2 • With H-rail mounting: Severity level 1	
Shock resistance	Tested to DIN/IEC68/EN60068, Part 2-27 • With wall mounting: Severity level 2 • With H-rail mounting: Severity level 1	
Materials	Reinforced PA	
Dimensions (W x H x D)	[mm]	81 x 137 x 28
Product weight	[g]	150

Operating and environmental conditions		
Ambient temperature	[°C]	0 ... 50
CE marking (see declaration of conformity)	To EU EMC Directive ¹⁾	
	To EU Explosion Protection Directive (ATEX)	
ATEX category	Gas	II 3 G
	Dust	II 3 D
Ex ignition protection type	Gas	Ex nA IIC T6 X Gc
	Dust	Ex tc IIIC T60°C X Dc IP65
ATEX temperature rating	[°C]	-5 ≤ Ta ≤ +50

1) For information about the applicability of the component see the manufacturer's EC declaration of conformity at: www.festo.com/sp → User documentation.
If the component is subject to restrictions on usage in residential, office or commercial environments or small businesses, further measures to reduce the emitted interference may be necessary.

 Note

When operating device combinations in hazardous areas, the lowest common zone, temperature class and ambient temperature of the individual devices determine the possible use of the entire module.

Connection and display components

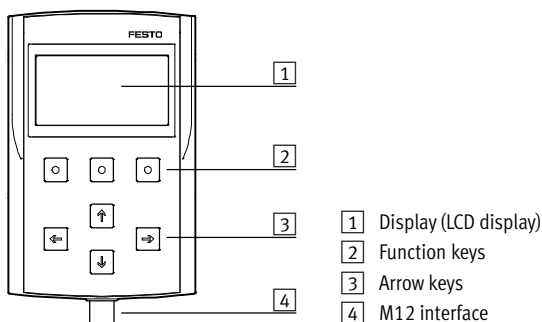



Terminal CPX-P

Technical data – Operator unit CPX-MMI-1

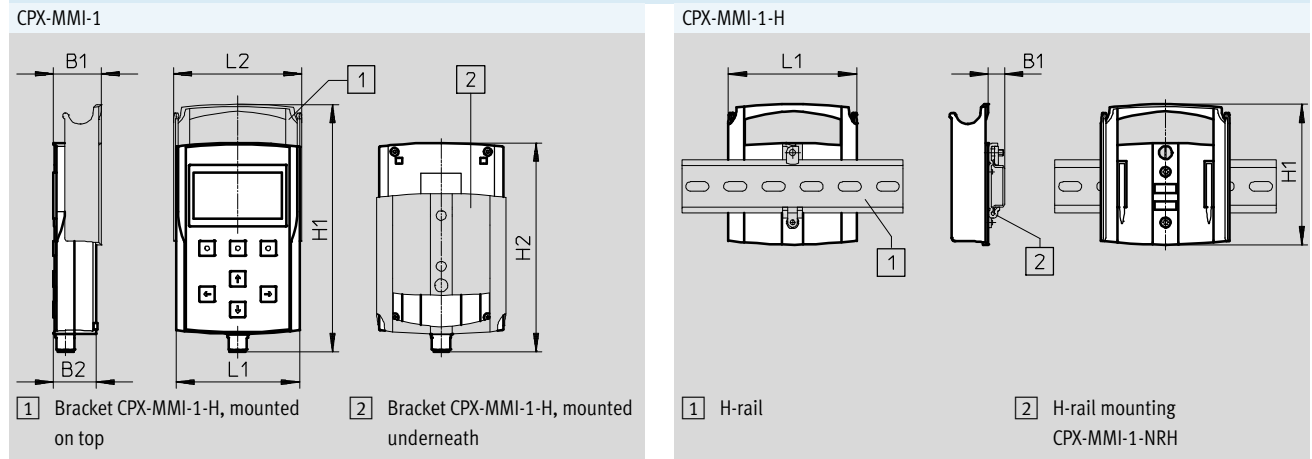
Dimensions Download CAD data → www.festo.com

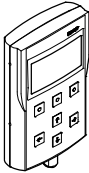

Type	B1	B2	H1	H2	L1	L2
CPX-MMI-1	31.4	28	162	137	81	84.3
CPX-MMI-1-H	10.6	–	92	–	84.3	–

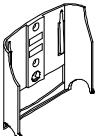
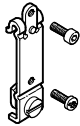
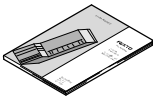
Ordering data			
Designation		Part No.	Type
Operator unit			
	Provides data polling, configuration and diagnostic functions for CPX-P terminals	529043	CPX-MMI-1
Connecting cable			
	Connecting cable M12-M12, specially for CPX-MMI	1.5 m	529044 KV-M12-M12-1,5
		3.5 m	530901 KV-M12-M12-3,5
Mounting			
	Bracket	534705	CPX-MMI-1-H
	Mounting for H-rail	536689	CPX-MMI-1-NRH
User documentation			
	User documentation for operator unit CPX-MMI-1	German	534824 P.BE-CPX-MMI-1-DE
		English	534825 P.BE-CPX-MMI-1-EN
		French	534827 P.BE-CPX-MMI-1-FR
		Italian	534828 P.BE-CPX-MMI-1-IT
		Swedish	534829 P.BE-CPX-MMI-1-SV
		Spanish	534826 P.BE-CPX-MMI-1-ES

Terminal CPX-P

Technical data – CPX Maintenance Tool



Function

CPX-P Maintenance Tool (CPX-FMT) combines service software with a connecting adapter. The service software is a tool for the design, parameterisation and online diagnostics of the CPX-P terminal. The USB-to-M12 adapter features built-in galvanic isolation (between CPX-P and PC) and enables a PC to be connected to the diagnostic interface of the CPX-P terminal.

- Adapter
- Software on CD-ROM

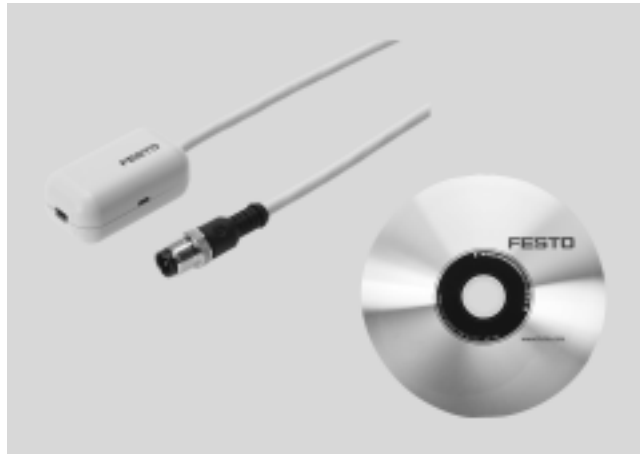

Application

Only from Festo

The CPX-FMT software enables access to CPX-P valve terminals via Ethernet with the control block CPX-FEC and the bus nodes EtherNet/IP (FB 32) and PROFINET (FB 33, FB 34, FB 35). The bus nodes or control block can be connected directly to the PC via a USB adapter from Festo. Similar to the operator unit (CPX-MMI), diagnostic data such as the error trace or module

diagnostics can be read out and parameters can be modified in plain text. In contrast to the operator unit (CPX-MMI), the data can be used directly on a PC. There is an option, for example, to send screenshots of a configuration or the current error trace directly via e-mail. In addition, CPX-P configurations can also be saved and

archived directly as a CPX-FMT project. Undocumented changes can subsequently be identified using the online/offline comparison function. On-site tests such as the actuation of valves or the emulation of sensor feedback (in both cases called "forcing"), for example, can be performed without an existing

controller infrastructure. It must be noted that with both the CPX-P Maintenance Tool (CPX-FMT) and the operator unit (CPX-MMI), only local parameters on the CPX-P valve terminal can be changed and saved. The configuration of the networks or controller software cannot be influenced.

General technical data		
Type	NEFC-M12G5-0.3-U1G5	
System requirements	PC	IBM-compatible
	Drive	CD-ROM
	Interfaces	USB port (specification USB 1.1 or higher)
	Operating system	Microsoft Windows 2000 or XP
Functional range	<ul style="list-style-type: none"> • Configuration and parameterisation • Reading out of system, module, channel diagnostics and error trace • Saving of the configuration as a project • Integration of plug-ins/links to self-executing programs 	
Scope of delivery	<ul style="list-style-type: none"> • Adapter M12, 5-pin to mini USB socket • CD-ROM with installation program 	
Type of mounting	Screw-in	
Electrical connection	Plug M12x1, 5-pin	
Adapter cable composition	4 x 0.34 mm ²	
Cable length	[m]	0.3
Protection class to EN 60529	IP20	
CE marking (see declaration of conformity)	To EU EMC Directive	
Ambient temperature	[°C]	-5 ... +50
Material	Housing	ABS
	Cable sheath	PUR
	Pin contact	Gold-plated brass
Note on materials	RoHS-compliant	

Terminal CPX-P

Technical data – CPX Maintenance Tool

Display components

Creating a device configuration using the editor

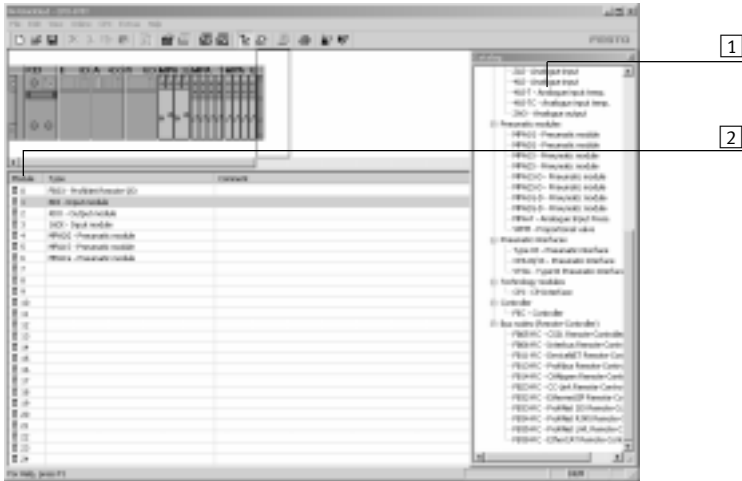

The device configuration can be conveniently generated, parameterised and saved using the drag & drop feature. You can insert and move modules.

- 1 Module numbers from the graphic system overview
- 2 Catalogue for selecting required modules

Module overview for a selected module

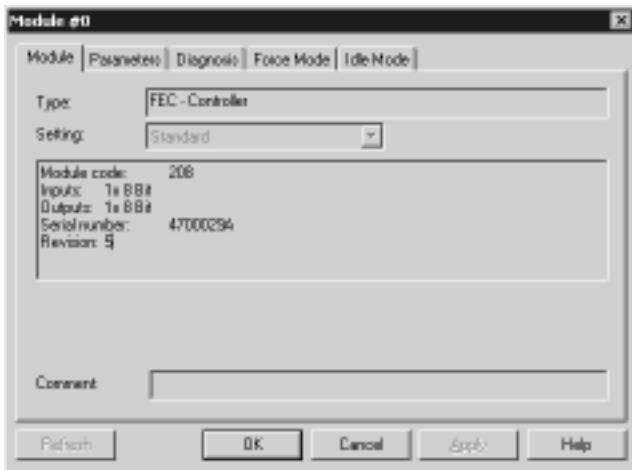

Displays important module data as well as the number of allocated inputs and outputs.

Diagnostic memory

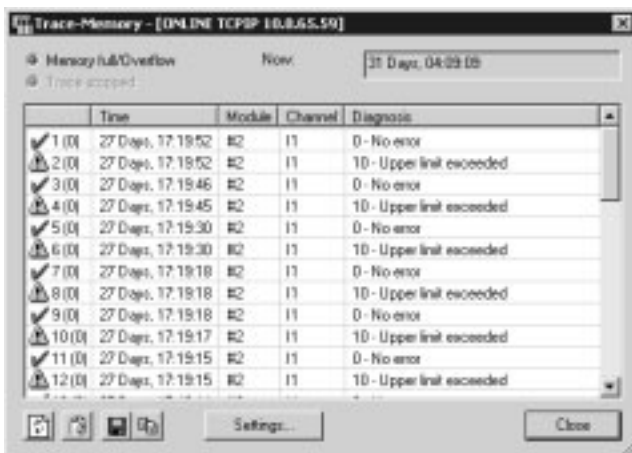

Faults which occur during operation are entered in a diagnostic memory. The first or the last 40 entries are saved, as well as the respective time measured from the moment the power supply was switched on.

Terminal CPX-P

Technical data – CPX Maintenance Tool

FESTO

Dimensions

Download CAD data → www.festo.com

Adapter

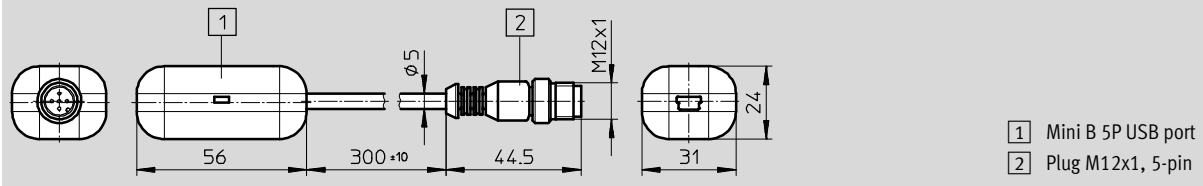

Ordering data

Designation	Part No.	Type
 CPX-P Maintenance Tool (CPX-FMT), software and USB-to-M12 adapter	547432	NEFC-M12G5-0.3-U1G5

Terminal CPX-P

Technical data – Control block CPX-FEC

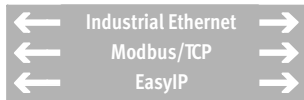

IT services:



Powerful control block for pre-processing actuation of the CPX-P modules.

The power supply to and communication with other modules takes place via the interlinking block.

In addition to the connection for the Ethernet interface in RJ45 and a programming interface in Sub-D, LEDs are also provided for the bus status, operating status of the PLC and CPX-P peripherals information, as are switching elements and a diagnostic interface for the operator unit (CPX-MMI) and CPX-P Maintenance Tool (CPX-FMT).



Application

Bus connection
The CPX-FEC is a remote controller that can be connected to a master PLC via Ethernet.

Modbus/TCP (code T05)
Transmits data in binary format within TCP/IP packets. This ensures good data throughput.

Operating mode	Communication protocols		
<ul style="list-style-type: none"> Remote I/O Modbus/TCP 	<ul style="list-style-type: none"> Modbus/TCP EasyIP 	<ul style="list-style-type: none"> IP TCP UDP SMTP 	<ul style="list-style-type: none"> HTTP DHCP BootP TFTP

Setting options			
CPX-FEC has the following interfaces for monitoring, programming and commissioning:	<ul style="list-style-type: none"> Operator unit (CPX-MMI) CPX-P Maintenance Tool (CPX-FMT) Serial interface RS232, for example, for a Front End Display (FED) Ethernet interface for IT applications Remote diagnostics 	The operating mode and fieldbus protocol are set using the DIL switch on the CPX-FEC.	The integrated web server offers a convenient means of querying data saved in the CPX-FEC.

Terminal CPX-P

Technical data – Control block CPX-FEC



General technical data			
Type		CPX-FEC-1-IE	
Ethernet interface		RJ45 (8-pin, socket)	
Data interface		RS232 (Sub-D, 9-pin, socket)	
MMI/FMT interface		M12, 5-pin, socket	
Baud rate	Ethernet interface	[Mbps]	10/100 (to IEEE802.3, 10BaseT)
	Data interface	[kbps]	9.6 ... 115.2
	MMI/FMT interface	[kbps]	56.6
Protocol		<ul style="list-style-type: none"> • TCP/IP • Easy IP • Modbus TCP • HTTP 	
Processing time for 1,024 binary instructions		[ms]	Approx. 1
Flags		M0.0 ... M9999, addressable as bits or words	
		No. of time flags	T0 ... T255
		Time range	[s] 0.01 to 655.35
		No. of counting flags	Z0 ... Z255
		Counting range	0 to 65535
Register		R0 ... R255, addressable as words	
Special FE		FE 0 ... 255, init flag	
IP address setting		BOOTP/DHCP via FST or via MMI/FMT	
Max. address capacity	Inputs	[byte]	64
	Outputs	[byte]	64
Program memory	User program	[kB]	250
	Web applications	[kB]	550
Programming language		<ul style="list-style-type: none"> • IL • LDR 	
Arithmetic functions		+, -, *, /, further functions via functional modules	
Functional modules		<ul style="list-style-type: none"> • CPX-P diagnostic status • Copy CPX-P diagnostic trace • Read CPX-P module diagnostics • Write CPX-P module parameter • etc. 	
No. of programs/tasks		P0 ... P63	
LED displays (FEC-specific)		RUN = Program is being executed/Modbus connection active STOP = Program is stopped/no Modbus connection ERR = Error in the program execution TP = Status of the Ethernet connection	
Device-specific diagnostics		Module and channel-oriented diagnostics via peripherals error	
Parameterisation		<ul style="list-style-type: none"> • Start-up parameterisation via FST • Parameterisation during the operating time via functional module 	
Control elements		<ul style="list-style-type: none"> • DIL switch for setting the operating mode • Rotary switch for program selection/program start 	
Additional functions		<ul style="list-style-type: none"> • Storage of the last 40 errors with timestamp (access via PCP) • 8-bit system status in image table for inputs • 2-byte inputs and 2-byte outputs, system diagnostics in image table 	

Terminal CPX-P

Technical data – Control block CPX-FEC

General technical data			
Operating voltage	Nominal value	[V DC]	24 (reverse polarity protected)
	Permissible range	[V DC]	18 ... 30
	Power failure buffering	[ms]	10
Residual ripple		[Vss]	4
Current consumption		[mA]	Max. 200
Interference emission	To EN 61000-6-4 (industry)		
Interference immunity	To EN 61000-6-2 (industry)		
Protection class to EN 60529	IP65, IP67		
Temperature range	Operation	[°C]	-5 ... +50
	Storage/transport	[°C]	-20 ... +70
Materials	Plastic		
Grid dimension		[mm]	50
Dimensions (incl. interlinking block) W x L x H		[mm]	50 x 107 x 55
Product weight		[g]	140



Note

Please observe the general limits and guidelines for the system when configuring the electrical modules.

Overview of the operating modes	
	Remote I/O
	Modbus/TCP
CPX-FEC function	Ethernet slave
CPX-P modules controlled by	Higher-order controller
Pre-processing of data in the FEC	No
Communication with higher-order controller	Via Ethernet <ul style="list-style-type: none"> • EasyIP • Modbus/TCP
Web server	Possible
Configuration	Higher-order controller
Parameterisation	Via FST, operator unit (CPX-MMI), CPX-P Maintenance Tool (CPX-FMT), Modbus
Order code	T05
Addressing	Preset
Memory	<ul style="list-style-type: none"> • 800 kB for web applications
Operator unit (CPX-MMI), CPX-P Maintenance Tool (CPX-FMT)	Can be connected to CPX-FEC

Terminal CPX-P

Technical data – Control block CPX-FEC

Connection and display components

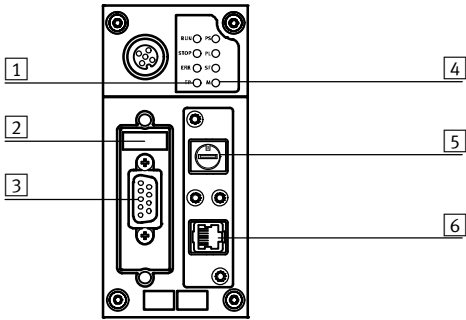

- 1 Controller and Ethernet LEDs
- 2 DIL switch for operating mode
- 3 Interface RS232 (9-pin Sub-D, socket)
- 4 CPX-P-specific status LEDs
- 5 16-way rotary switch (program selection)
- 6 Ethernet connection (8-pin RJ45, socket)

Pin allocation for the programming interface (RS232)







Pin allocation	Pin	Signal	Designation
Sub-D socket			
	1	n.c.	Not connected
	2	RxD	Received data
	3	TxD-P	Transmitted data
	4	n.c.	Not connected
	5	GND	Data reference potential
	6	n.c.	Not connected
	7	n.c.	Not connected
	8	n.c.	Not connected
	9	n.c.	Not connected
	Housing	Screened	Connection to functional earth (FE)

Pin allocation for the Ethernet interface

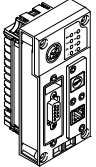
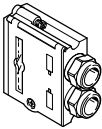
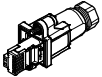
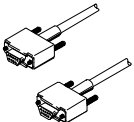
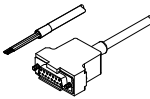
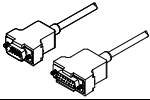
Pin allocation	Pin	Signal	Designation
RJ45 plug			
	1	TD+	Transmitted data+
	2	TD-	Transmitted data-
	3	RD+	Received data+
	4	n.c.	Not connected
	5	n.c.	Not connected
	6	RD-	Received data-
	7	n.c.	Not connected
	8	n.c.	Not connected
Housing	Screened	Screened	

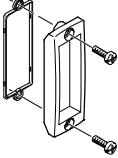
Terminal CPX-P

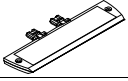

Technical data – Control block CPX-FEC

Ordering data			
Designation		Part No.	Type
Control block			
	For pre-processing actuation of the CPX-P modules	529041	CPX-FEC-1-IE
Bus connection			
	Sub-D plug	534497	FBS-SUB-9-GS-1x9POL-B
	RJ45/plug	534494	FBS-RJ45-8-GS
	Programming cable, 3 m	151915	KDI-PPA-3-BU9
	Connecting cable from the control block CPX-FEC to a display and operating unit (FED), pre-assembled at one end	539642	FEC-KBG7
	Connecting cable from the control block CPX-FEC to a display and operating unit (FED), pre-assembled at both ends	539643	FEC-KBG8
Covers			
	Cover cap for sealing unused M12 connections (10 pieces)	165592	ISK-M12
	Inspection cover, transparent, for Sub-D connection	533334	AK-SUB-9/15-B
	Cover for RJ45 connection	534496	AK-RJ45
Inscription label			
	Inscription label holder for connection block	536593	CPX-ST-1
	Inscription labels 6x10 mm, 64 pieces, in frames	18576	IBS-6x10

Terminal CPX-P

Technical data – Control block CPX-FEC



Ordering data				
Designation			Part No.	Type
User documentation				
	User documentation for control block CPX-FEC	German	538474	P.BE-CPX-FEC-DE
		English	538475	P.BE-CPX-FEC-EN
		Spanish	538476	P.BE-CPX-FEC-ES
		French	538477	P.BE-CPX-FEC-FR
		Italian	538478	P.BE-CPX-FEC-IT
		Swedish	538479	P.BE-CPX-FEC-SV
Software				
	Programming software	German	537927	P.SW-FST4-CD-DE
		English	537928	P.SW-FST4-CD-EN
	Adapter from 5-pin M12 to mini USB socket and controller software		547432	NEFC-M12G5-0.3-U1G5

Terminal CPX-P

Technical data – Bus node CPX-FB11



Bus node for handling communication between the electrical CPX-P terminal and a DeviceNet network.

The bus node is provided with system supply via the interlinking block and processes communication with the I/O modules.

The status of the CPX-P terminal is displayed as a common message via four CPX-P-specific LEDs.

The fieldbus communication status is displayed via the three DeviceNet-specific LEDs.



Application

Bus connection

The bus connection can be selected when ordering, either Micro Style as 2xM12 round connectors or Open-Style as a terminal strip with IP20 protection.

Both connection types have the function of an integrated T-distributor with incoming and outgoing bus line.

DeviceNet implementation

The CPX-FB11 operates with the "Predefined Master/Slave Connection Set" as a "Group 2 Only Server". The polled I/O, change of state or cyclic method is used for the transmission of cyclic I/O data. The type of transmission can be selected in the network configuration.

The device diagnostics for all bus nodes CPX-FB11 is effectively gathered via strobed I/O and displayed in the input table of the controller.

In addition to cyclic data transmission, acyclic communication is supported through explicit messaging, which enables detailed device diagnostics and parameterisation.

A comprehensive EDS file supports the display of acyclic data. It is also possible to display system information and assign parameters while the controller is running via the user program or the configuration software.

An example of this is access to the integrated diagnostic memory function, i.e. storage of the last 40 errors with timestamp, module, channel and error type.

With its address capacity of 64 byte inputs and 64 byte outputs, the CPX-FB11 supports any configuration of I/O modules, including pneumatic interface.

Points to note in connection with CPX-FEC/CPX-CEC

When a bus node is combined with a control block (CPX-FEC, CPX-CEC, in the fieldbus remote controller operating mode), the connected I/Os and/or valves, sensors and actuators are controlled via the CPX-P control block.

In this case, the bus node only provides the communication interface to the PLC.

Communication between the control block and CPX-P bus node is

established by interlinking the CPX-P modules and occupies the following address capacity in the CPX-P system:

- 8 byte outputs
- 8 byte inputs

The remaining address capacity of the control block or CPX-P system for actuating the peripherals is:

- 56 byte inputs
- 56 byte outputs

Terminal CPX-P

Technical data – Bus node CPX-FB11

FESTO

General technical data			
Type	CPX-FB11		
Fieldbus interface	Either <ul style="list-style-type: none"> • Micro Style bus connection: 2xM12 with IP65/IP67 protection • Open Style bus connection: 5-pin terminal strip, IP20 		
Baud rate	[kbps]	125, 250, 500	
Addressing range	0 ... 63 Set using DIL switch		
Product	Type	Communication adapter (12 dec.)	
	Code	4554 dec.	
Communication types	Polled I/O, change of state/cyclic, strobed I/O and explicit messaging		
Configuration support	EDS file and bitmaps		
Max. address capacity	Inputs	[byte]	64
	Outputs	[byte]	64
LED displays (bus-specific)	MS = Module status NS = Network status IO = I/O status		
Device-specific diagnostics	Module and channel-oriented diagnostics by means of manufacturer-specific diagnostic object		
Parameterisation	<ul style="list-style-type: none"> • Module and system parameterisation via configuration interface in plain text (EDS) • Online in run or program mode 		
Additional functions	<ul style="list-style-type: none"> • Storage of the last 40 errors with timestamp (access via EDS) • 8-bit system status in image table for inputs • 2-byte inputs and 2-byte outputs, system diagnostics in image table 		
Control elements	DIL switch		
Operating voltage	Nominal value	[V DC]	24
	Permissible range	[V DC]	18 ... 30
	Power failure buffering	[ms]	10
Current consumption			[mA] Typically 200
Protection class to EN 60529	IP65, IP67		
Temperature range	Operation	[°C]	-5 ... +50
	Storage/transport	[°C]	-20 ... +70
Materials	PA-reinforced PC		
Grid dimension			[mm] 50
Dimensions (incl. interlinking block) W x L x H			[mm] 50 x 107 x 50
Product weight			[g] 120

 - Note

Please observe the general limits and guidelines for the system when configuring the electrical modules.

Terminal CPX-P

Technical data – Bus node CPX-FB11

Connection and display components

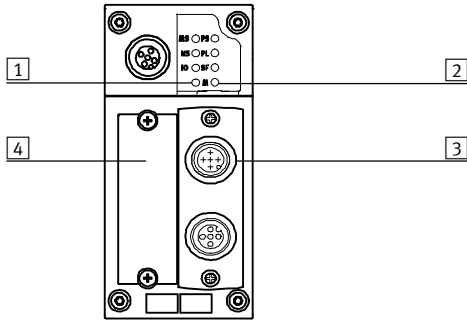

- 1 Bus-specific LEDs
- 2 CPX-P-specific status LEDs
- 3 Selectable fieldbus connection
Micro Style
Open Style
- 4 DIL switch cover







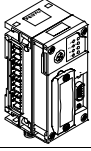
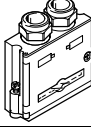

Pin allocation for the DeviceNet interface

Pin allocation	Pin	Signal-specific core colour ¹⁾	Signal	Designation
Sub-D plug				
	1	–	n.c.	Not connected
	2	Blue	CAN_L	Received/transmitted data low
	3	Black	0 V bus	0 V CAN interface
	4	–	n.c.	Not connected
	5	Blank	Screened	Connection to housing
	6	–	n.c.	Not connected
	7	White	CAN_H	Received/transmitted data high
	8	–	n.c.	Not connected
	9	Red	24 V DC bus	24 V DC supply for CAN interface
Micro Style bus connection (M12), incoming/outgoing				
Incoming 	1	Blank	Screened	Connection to housing
	2	Red	24 V DC bus	24 V DC supply for CAN interface
	3	Black	0 V bus	0 V CAN interface
	4	White	CAN_H	Received/transmitted data high
	5	Blue	CAN_L	Received/transmitted data low
Outgoing 	1	Blank	Screened	Connection to housing
	2	Red	24 V DC bus	24 V DC supply for CAN interface
	3	Black	0 V bus	0 V CAN interface
	4	White	CAN_H	Received/transmitted data high
	5	Blue	CAN_L	Received/transmitted data low
Open Style bus connection				
	1	Black	0 V bus	0 V CAN interface
	2	Blue	CAN_L	Received/transmitted data low
	3	Blank	Screened	Connection to housing
	4	White	CAN_H	Received/transmitted data high
	5	Red	24 V DC bus	24 V DC supply for CAN interface
7/8" bus connection				
	1	Black	Screened	Connection to housing
	2	Blue	24 V DC	24 V DC supply for CAN interface
	3	Blank	0 V	0 V CAN interface
	4	White	CAN_H	Received/transmitted data high
	5	Red	CAN_L	Received/transmitted data low

1) Typical for DeviceNet cables

Terminal CPX-P

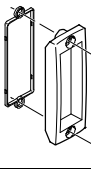
Technical data – Bus node CPX-FB11

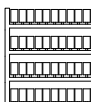
Ordering data			
Designation		Part No.	Type
Bus node			
	DeviceNet bus node	526172	CPX-FB11
Bus connection			
	Sub-D plug	532219	FBS-SUB-9-BU-2x5POL-B
	Connection block, 9-pin Sub-D socket, 5-pin 7/8" plug	571052	CPX-AB-1-7/8-DN
	Micro Style bus connection, 2xM12	525632	FBA-2-M12-5POL
	Socket for Micro Style connection, M12	18324	FBSD-GD-9-5POL
	Plug for Micro Style connection, M12	175380	FBS-M12-5GS-PG9
	Open Style bus connection for 5-pin terminal strip	525634	FBA-1-SL-5POL
	Terminal strip for Open Style connection, 5-pin	525635	FBSD-KL-2x5POL
Covers			
	Cover cap for sealing unused M12 connections (10 pieces)	165592	ISK-M12
	Inspection cover, transparent, for Sub-D connection	533334	AK-SUB-9/15-B
Inscription label			
	Inscription label holder for connection block	536593	CPX-ST-1
	Inscription labels 6x10 mm, 64 pieces, in frames	18576	IBS-6x10

Terminal CPX-P

Technical data – Bus node CPX-FB11

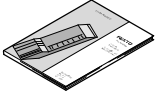
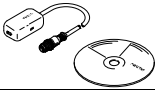
Ordering data				
Designation			Part No.	Type
User documentation				
	User documentation for bus node CPX-FB11	German	526421	P.BE-CPX-FB11-DE
		English	526422	P.BE-CPX-FB11-EN
		Spanish	526423	P.BE-CPX-FB11-ES
		French	526424	P.BE-CPX-FB11-FR
		Italian	526425	P.BE-CPX-FB11-IT
		Swedish	526426	P.BE-CPX-FB11-SV
Software				
	Adapter from 5-pin M12 to mini USB socket and controller software		547432	NEFC-M12G5-0.3-U1G5

Terminal CPX-P

Technical data – Bus node CPX-FB13



Bus node for handling communication between the electrical CPX-P terminal and a higher-order master via PROFIBUS DP.

The bus node is provided with system supply via the interlinking block and processes communication with the I/O modules.

The status of the CPX-P terminal is displayed as a common message via four CPX-P-specific LEDs.

The fieldbus communication status is displayed via the PROFIBUS-specific error LED.



Application

Bus connection

The bus connection is established via a 9-pin Sub-D socket with a typical PROFIBUS allocation (to EN 50170).

The bus connector plug (with IP65/IP67 protection from Festo or IP20 protection from other manufacturers) facilitates the connection of an incoming and an outgoing bus cable.

An active bus terminal can be connected using the DIL switch integrated in the plug.

The Sub-D interface is designed for controlling network components with a fibre-optic cable connection.

PROFIBUS DP implementation

The CPX-FB13 supports the PROFIBUS DP protocol to EN 50170 Volume 2 for cyclic I/O exchange, parameterisation and diagnostic functions (DPV0).

In addition to DPV0, acyclic communication to the advanced specification DPV1 is supported. DPV1 provides acyclic access to advanced system information and assigns operation parameters while the controller is running via the user program.

An example of this is access to the integrated diagnostic memory function, i.e. storage of the last 40 errors with timestamp, module, channel and error type.

With its address capacity of 64 byte inputs and 64 byte outputs, the CPX-FB13 supports any configuration of I/O modules, including pneumatic interface.

Points to note in connection with CPX-FEC/CPX-CEC

When a bus node is combined with a control block (CPX-FEC, CPX-CEC, in the fieldbus remote controller operating mode), the connected I/Os and/or valves, sensors and actuators are controlled via the CPX-P control block.

In this case, the bus node only provides the communication interface to the PLC.

Communication between the control block and CPX-P bus node is

established by interlinking the CPX-P modules and occupies the following address capacity in the CPX-P system:

- 8 byte outputs
- 8 byte inputs

The remaining address capacity of the control block or CPX-P system for actuating the peripherals is:

- 56 byte inputs
- 56 byte outputs

Terminal CPX-P

Technical data – Bus node CPX-FB13

General technical data			
Type		CPX-FB13	
Fieldbus interface		Sub-D socket, 9-pin (EN 50170) Galvanically isolated 5 V	
Baud rate	[Mbps]	0.0096 ... 12	
Addressing range		1 ... 125 Set using DIL switch	
Product range		4: Valves	
Ident. number		0x059E	
Communication types		DPV0: Cyclic communication DPV1: Acyclic communication	
Configuration support		GSD file and bitmaps	
Max. address capacity	Inputs	[byte]	64
	Outputs	[byte]	64
LED displays (bus-specific)		BF: Bus fault	
Device-specific diagnostics		Identifier and channel-oriented diagnostics to EN 50170 (PROFIBUS standard)	
Parameterisation		<ul style="list-style-type: none"> Start-up parameterisation via configuration interface in plain text (GSD) Acyclic parameterisation via DPV1 	
Additional functions		<ul style="list-style-type: none"> Storage of the last 40 errors with timestamp (access via DPV1) 8-bit system status in image table for inputs 2-byte inputs and 2-byte outputs, system diagnostics in image table 	
Control elements		DIL switch	
Operating voltage	Nominal value	[V DC]	24
	Permissible range	[V DC]	18 ... 30
	Power failure buffering	[ms]	10
Current consumption		[mA]	Typically 200
Protection class to EN 60529		IP65, IP67	
Temperature range	Operation	[°C]	-5 ... +50
	Storage/transport	[°C]	-20 ... +70
Materials		PA-reinforced PC	
RoHS status		RoHS-compliant in accordance with EU Directive	
Grid dimension		[mm]	50
Dimensions (incl. interlinking block) W x L x H		[mm]	50 x 107 x 50
Product weight		[g]	115

 Note

Please observe the general limits and guidelines for the system when configuring the electrical modules.

Terminal CPX-P

Technical data – Bus node CPX-FB13

Connection and display components

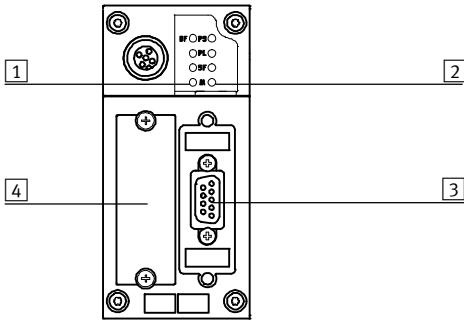

- 1 Bus status LEDs/bus fault
- 2 CPX-P-specific status LEDs
- 3 Fieldbus connection (9-pin Sub-D socket)
- 4 DIL switch cover







Pin allocation for PROFIBUS DP interface

Pin allocation	Pin	Signal	Designation
Sub-D socket			
	1	n.c.	Not connected
	2	n.c.	Not connected
	3	RxD/TxD-P	Received/transmitted data P
	4	CNTR-P ¹⁾	Repeater control signal
	5	DGND	Data reference potential (M5V)
	6	VP	Supply voltage (P5V)
	7	n.c.	Not connected
	8	RxD/TxD-N	Received/transmitted data N
	9	n.c.	Not connected
	Housing	Screened	Connection to housing
Bus connection M12 adapter (B-coded)			
Incoming 	1	n.c.	Not connected
	2	RxD/TxD-N	Received/transmitted data N
	3	n.c.	Not connected
	4	RxD/TxD-P	Received/transmitted data P
	5 and M12	Screened	Connection to FE (functional earth)
Outgoing 	1	VP	Supply voltage (P5V)
	2	RxD/TxD-N	Received/transmitted data N
	3	DGND	Data reference potential (M5V)
	4	RxD/TxD-P	Received/transmitted data P
	5 and M12	Screened	Connection to FE (functional earth)

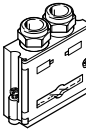
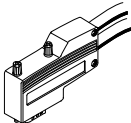
1) The repeater control signal CNTR-P is a TTL signal..

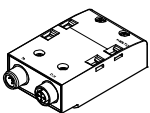
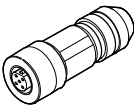
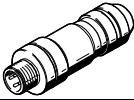
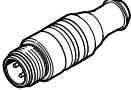
Terminal CPX-P

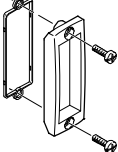
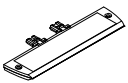

Technical data – Bus node CPX-FB13

Ordering data			
Designation		Part No.	Type
Bus node			
	PROFIBUS bus node	195740	CPX-FB13
Bus connection			
	Sub-D plug, straight	532216	FBS-SUB-9-GS-DP-B
	Sub-D plug, angled	533780	FBS-SUB-9-WS-PB-K
	Bus connection, adapter from 9-pin Sub-D plug to 5-pin M12 plug/socket, B-coded	533118	FBA-2-M12-5POL-RK
	Connection block, adapter from 9-pin Sub-D plug to 5-pin M12 plug/socket, B-coded	541519	CPX-AB-2-M12-RK-DP
	Socket M12x1, 5-pin, straight, for self-assembly of a connecting cable compatible with FBA-2-M12-5POL-RK and CPX-AB-2-M12-RK-DP	1067905	NECU-M-B12G5-C2-PB
	Plug M12x1, 5-pin, straight, for self-assembly of a connecting cable compatible with FBA-2-M12-5POL-RK and CPX-AB-2-M12-RK-DP	1066354	NECU-M-S-B12G5-C2-PB
	Terminating resistor, M12, B-coded for PROFIBUS	1072128	CACR-S-B12G5-220-PB
Covers			
	Cover cap for sealing unused M12 connections (10 pieces)	165592	ISK-M12
	Inspection cover, transparent, for Sub-D connection	533334	AK-SUB-9/15-B
Inscription label			
	Inscription label holder for connection block	536593	CPX-ST-1
	Inscription labels 6x10 mm, 64 pieces, in frames	18576	IBS-6x10

Terminal CPX-P

Technical data – Bus node CPX-FB13

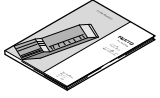

Ordering data				
Designation			Part No.	Type
User documentation				
	User documentation for bus node CPX-FB13	German	526427	P.BE-CPX-FB13-DE
		English	526428	P.BE-CPX-FB13-EN
		Spanish	526429	P.BE-CPX-FB13-ES
		French	526430	P.BE-CPX-FB13-FR
		Italian	526431	P.BE-CPX-FB13-IT
		Swedish	526432	P.BE-CPX-FB13-SV
Software				
	Adapter from 5-pin M12 to mini USB socket and controller software		547432	NEFC-M12G5-0.3-U1G5

Terminal CPX-P

Technical data – Bus node CPX-FB32



Bus node for handling communication between the electrical CPX-P terminal and the EtherNet/IP network.

The bus node is provided with system supply via the interlinking block and processes communication with the I/O modules.

The status of the CPX-P terminal is displayed as a common message via four CPX-P-specific LEDs.



Application

Bus connection

The bus connection is established via an M12 plug, D-coded to IEC947-5-2 with IP65, IP67 protection.

EtherNet/IP is an open bus system based on the Ethernet standard and TCP/IP technology (IEEE802.3).

EtherNet/IP implementation

The CPX-FB32 supports the two operating modes remote I/O and remote controller.

In remote I/O operating mode, all functions of the CPX-P valve terminal

are directly controlled by the EtherNet/IP master (host). In addition to actuation via a bus system, it is possible to use IT

technologies. An integrated web server enables diagnostic data to be visualised via HTML. Various programs support direct access to the data of the

device from the automation network. The EtherNet/IP node for CPX-P supports the transmission technology that conforms to DIN EN 50173/CAT 5.

Points to note in connection with CPX-FEC/CPX-CEC

When a bus node is combined with a control block (CPX-FEC, CPX-CEC, in the fieldbus remote controller operating mode), the connected I/Os and/or valves, sensors and actuators are controlled via the CPX-P control block.

In this case, the bus node only provides the communication interface to the PLC. Communication between the control block and CPX-P bus node is

established by interlinking the CPX-P modules and occupies the following address capacity in the CPX-P system:

- 8 byte outputs
- 8 byte inputs

The remaining address capacity of the control block or CPX-P system for actuating the peripherals is:

- 56 byte inputs
- 56 byte outputs

Terminal CPX-P

Technical data – Bus node CPX-FB32

General technical data			
Type	CPX-FB32		
Fieldbus interface	Socket, M12, D-coded, 4-pin		
Baud rate	[Mbps]	10/100, full/half duplex	
IP addressing	Via DHCP, DIL switch or network software		
Max. address capacity, inputs	[byte]	64	
Max. address capacity, outputs	[byte]	64	
LED displays (bus-specific)	MS = Module status NS = Network status IO = I/O status TP = Link/traffic		
Device-specific diagnostics	System, module and channel-oriented diagnostics		
Parameterisation	<ul style="list-style-type: none"> Start-up parameterisation Acyclic parameterisation via Explicit Messaging 		
Additional functions	<ul style="list-style-type: none"> Storage of the last 40 errors with timestamp (access via system diagnostics) 8-bit system status in image table for inputs 2-byte I/O, system diagnostics via image table 		
Control elements	DIL switch		
Operating voltage	Nominal value	[V DC]	24
	Permissible range	[V DC]	18 ... 30
	Power failure buffering	[ms]	10
Current consumption	[mA]	Typically 65	
Protection class to EN 60529	IP65, IP67		
Temperature range	Operation	[°C]	-5 ... +50
	Storage/transport	[°C]	-20 ... +70
Materials	PA-reinforced PC		
Grid dimension	[mm]	50	
Dimensions (incl. interlinking block) W x L x H	[mm]	50 x 107 x 50	
Product weight	[g]	125	

 - Note
Please observe the general limits and guidelines for the system when configuring the electrical modules.

Terminal CPX-P

Technical data – Bus node CPX-FB32

Connection and display components

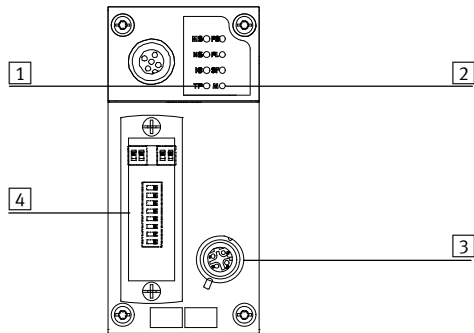

- 1 Bus-specific status LEDs
- 2 CPX-P-specific status LEDs
- 3 Fieldbus connection (4-pin socket M12, D-coded)
- 4 Transparent DIL switch cover





Pin allocation for the fieldbus interface

Pin allocation	Pin	Signal	Designation
M12 socket, D-coded			
	1	TD+	Transmitted data+
	2	RD+	Received data+
	3	TD-	Transmitted data-
	4	RD-	Received data-
	Housing		

Terminal CPX-P

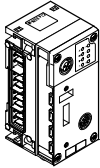
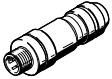
Technical data – Bus node CPX-FB32

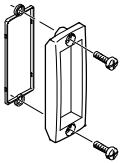
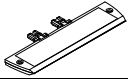
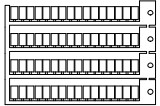
FESTO

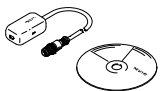
Ordering data			
Designation		Part No.	Type
Bus node			
	EtherNet/IP bus node	541302	CPX-FB32
Bus connection			
	Plug M12x1, 4-pin, D-coded	543109	NECU-M-S-D12G4-C2-ET
Covers			
	Cover cap for sealing unused M12 connections (10 pieces)	165592	ISK-M12
	Inspection cover, transparent, for DIL switch	533334	AK-SUB-9/15-B
Inscription label			
	Inscription label holder for connection block	536593	CPX-ST-1
	Inscription labels 6x10 mm, 64 pieces, in frames	18576	IBS-6x10
User documentation			
	User documentation for bus node CPX-FB32	German	541304 P.BE-CPX-FB32-DE
		English	541305 P.BE-CPX-FB32-EN
		Spanish	541306 P.BE-CPX-FB32-ES
		French	541307 P.BE-CPX-FB32-FR
		Italian	541308 P.BE-CPX-FB32-IT
		Swedish	541309 P.BE-CPX-FB32-SV
Software			
	Adapter from 5-pin M12 to mini USB socket and controller software	547432	NEFC-M12G5-0.3-U1G5

Terminal CPX-P

Technical data – Bus node CPX-FB33



Bus node for operating the CPX-P valve terminal on PROFINET. The bus node is provided with system supply via the interlinking block and processes communication with the I/O modules. The status of the CPX-P terminal is displayed as a common message via four CPX-P-specific LEDs. The fieldbus communication status is displayed via three bus-specific LEDs.



Application

Bus connection

The bus connection is established via two M12 sockets, D-coded to IEC61076-2-101 with IP65, 67 protection.

Both connections are equivalent 100BaseTX Ethernet ports with integrated auto MDI functionality (cross-over and patch cables can be used) that are brought together via an internal switch.

- Maximum segment length 100 m
- Baud rate 100 Mbps

PROFINET implementation

The CPX-FB33 supports the PROFINET protocol based on the Ethernet standard and the TCP/IP technology to IEEE802.3. This guarantees a data exchange with a high data transmission rate, for example I/O data from sensors, actuators or robot controllers, PLCs or process equipment. In addition, non-real-time critical information such as diagnostic information, configuration information, etc. can be transferred. The Ethernet bandwidth is sufficient to transfer both data types (real-time and non-real-time) in parallel.

The bus node features LEDs for bus status and CPX-P peripheral information as well as switch elements, memory stick and a diagnostic interface. The purpose of the memory stick is to guarantee fast replacement of the bus node in the event of an error. PROFINET provides the user with access to all peripherals, diagnostic data and parameter data of the CPX-P valve terminal. The bus node can be used as a remote I/O or remote controller. All information relevant to the CPX-P can be read out and, depending on the function, changed via an operator unit (CPX-MMI).

Points to note in connection with CPX-FEC/CPX-CEC

When a bus node is combined with a control block (CPX-FEC, CPX-CEC, in the fieldbus remote controller operating mode), the connected I/Os and/or valves, sensors and actuators are controlled via the CPX-P control block.

In this case, the bus node only provides the communication interface to the PLC. Communication between the control block and CPX-P bus node takes place by interlinking the CPX-P modules and takes up the following address capacity in the CPX-P system:

- 8 byte outputs
- 8 byte inputs

The remaining address capacity of the control block or CPX-P system for actuating the peripherals is:

- 56 byte inputs
- 56 byte outputs

Terminal CPX-P

Technical data – Bus node CPX-FB33



General technical data			
Type		CPX-FB33	
Fieldbus interface		2x M12 socket, D-coded, 4-pin	
Baud rate	[Mbps]	100	
Protocol		PROFINET RT PROFINET IRT	
Max. address capacity	Inputs	[byte]	64
	Outputs	[byte]	64
LED displays	(bus-specific)		M/P = Maintenance/PROFenergy NF = Network fault TP1 = Network active port 1 TP2 = Network active port 2
	(product-specific)		M = Modify, parameterisation PL = Load supply PS = Electronic supply, sensor supply SF = System fault
Device-specific diagnostics		<ul style="list-style-type: none"> • Channel and module-oriented diagnostics • Undervoltage of modules • Diagnostic memory 	
Configuration support		GSDML file	
Parameterisation		<ul style="list-style-type: none"> • System parameters • Diagnostic behaviour • Signal setup • Fail-safe response • Forcing of channels 	
Additional functions		<ul style="list-style-type: none"> • Start-up parameterisation in plain text via fieldbus • Fast startup (FSU) • Channel-oriented diagnostics via fieldbus • Acyclic data access via fieldbus • System status can be represented using process data • Additional diagnostic interface for operator units • Acyclic data access via EtherCat 	
Control elements		<ul style="list-style-type: none"> • DIL switch • Optional memory card 	
Operating voltage	Nominal value	[V DC]	24
	Permissible range	[V DC]	18 ... 30
Current consumption		[mA]	Typically 120
Protection class to EN 60529		IP65, IP67	
Temperature range	Operation	[°C]	-5 ... +50
	Storage/transport	[°C]	-20 ... +70
Materials		Housing	Die-cast aluminium
Grid dimension		[mm]	50
Dimensions (incl. interlinking block) W x L x H		[mm]	50 x 107 x 50
Product weight		[g]	280

 - Note
Please observe the general limits and guidelines for the system when configuring the electrical modules.

 - Note
Always use screws appropriate to the interlinking block (metal or plastic):

- Self-tapping screws for plastic interlinking blocks
- Screws with metric thread for metal interlinking blocks

Terminal CPX-P

Technical data – Bus node CPX-FB33

Connection and display components

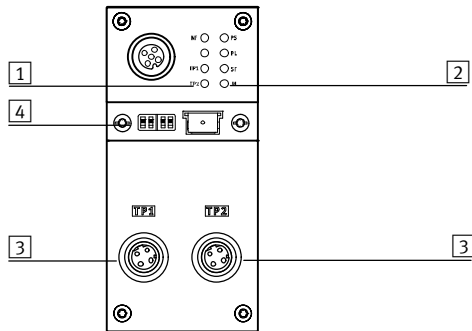

- 1 Bus-specific status LEDs
- 2 CPX-P-specific status LEDs
- 3 Fieldbus connection (4-pin socket M12, D-coded)
- 4 Transparent cover for DIL switch and memory card







Pin allocation for the fieldbus interface

Pin allocation	Pin	Signal	Designation
M12 socket, D-coded			
	1	TD+	Transmitted data+
	2	RD+	Received data+
	3	TD-	Transmitted data-
	4	RD-	Received data-
	Housing		

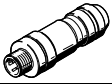
Terminal CPX-P

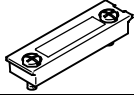
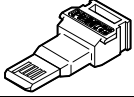
Technical data – Bus node CPX-FB33

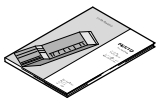
FESTO

Ordering data			
Designation		Part No.	Type
Bus node			
	PROFINET bus node	548755	CPX-FB33
Bus connection			
	Plug M12x1, 4-pin, D-coded	543109	NECU-M-S-D12G4-C2-ET
Covers			
	Cover cap for sealing unused M12 connections (10 pieces)	165592	ISK-M12
	Transparent cover for DIL switch and memory card	548757	CPX-AK-P
Function block			
	Memory card for PROFINET bus node, 2 MB	568647	CPX-SK-2
Screws			
	Screws for attaching an inscription label holder to the bus node (12 pieces)	550222	CPX-M-M2,5X8-12X
User documentation			
	Electronics manual, CPX-P bus node, type CPX-FB33	German	548759 P.BE-CPX-PNIO-DE
		English	548760 P.BE-CPX-PNIO-EN
		Spanish	548761 P.BE-CPX-PNIO-ES
		French	548762 P.BE-CPX-PNIO-FR
		Italian	548763 P.BE-CPX-PNIO-IT
		Swedish	548764 P.BE-CPX-PNIO-SV
Software			
	Adapter from 5-pin M12 to mini USB socket and controller software	547432	NEFC-M12G5-0.3-U1G5

Terminal CPX-P

Technical data – Input module, digital, NAMUR

Function

Digital input modules enable the connection of up to eight NAMUR sensors (or wired mechanical contacts). In addition, the first four channels can alternatively be used as counters or for frequency measurement.

M12 and terminal strip connection technology can be used.

Applications

- Input modules for 24 V DC sensor supply voltage
- Module features can be parameterised
- The input module receives the voltage supply for the electronics and the sensors from the interlinking block
- Module protection and diagnostics through integrated electronic fuse protection in each channel



General technical data		
Number of inputs		8
Max. cable length	[m]	200
Input debounce time	[ms]	3 (0, 10, 20 parameterisable)
Fuse protection (short circuit)		Internal electronic fuse for each channel
Module current consumption (voltage supply for electronics)	[mA]	Typically 75
Nominal operating voltage	[V DC]	24 (reverse polarity protected)
Permissible voltage fluctuations	[%]	±25
Power failure buffering	[ms]	20
Residual ripple	[Vss]	0.4
Electrical isolation	Channel – channel	No
	Channel – internal bus	Yes
Input characteristic curve		To EN 60947-5-6
Switching level		To EN 60947-5-6
LED displays	Group diagnostics	1
	Channel diagnostics	8
	Channel status	8
Diagnostics	Wire break per channel	
	Limit value violation per channel	
	Parameterisation error	
	Overload per channel	
Parameterisation	Data format	
	Input debounce time per channel	
	Input function per channel	
	Replacement value in diagnostic case per channel	
	Upper limit value per channel	
	Signal extension time per channel	
	Gate time per channel	
	Limit value monitoring per channel	
	Monitoring of short circuit per channel	
	Monitoring of wire break per channel	
	Monitoring of parameters	
	Lower limit value per channel	
	Counter configuration per channel	
Control elements		DIL switch
Additional functions		Frequency measurement
		Counter operation
Protection class to EN 60529		Depending on connection block
Grid dimension	[mm]	50
Dimensions (incl. interlinking block and connection block) W x L x H	[mm]	50 x 107 x 70
Product weight	[g]	100

Terminal CPX-P

Technical data – Input module, digital, NAMUR

Explosion protection parameters of the module inputs			
Type		CPX-P-8DE-N	CPX-P-8DE-N-IS
Maximum output power	[mW]	–	168
Maximum output voltage	[V]	–	10
Maximum output current	[mA]	–	16.8
Maximum external inductance	[mH]	–	0.00266
Maximum external capacitance	[µF]	–	1.1

Certifications and approvals – Maximum values			
Type		CPX-P-8DE-N	CPX-P-8DE-N-IS
ATEX category for gas		–	II (1) G
Explosion ignition protection type for gas		–	[Ex ia Ga] IIC
ATEX category for dust		–	II (1) D
Explosion ignition protection type for dust		–	[Ex ia Da] IIIC
Explosion protection certification outside the EU		–	EPL Da (IEC-EX)
		–	EPL Ga (IEC-EX)
Explosion-proof temperature	[°C]	–	–5 ≤ Ta ≤ +70
Certificate issuing authority		–	IECEX ZLM 12.0007 X
		–	ZELM 12 ATEX 0500 X

 Note
The module CPX-P-8DE-N-IS has additional safety measures for possible faults such as non-resettable fuses to ensure safe operation as per the ignition protection type. If the module is operated within the permissible parameters, these protective measures will be irrelevant.

 Note
Only the end plate, the pneumatic interface or another module in intrinsically safe design are permitted directly to the right of modules in intrinsically safe design (CPX-P-8DE-N-IS) within the CPX-P terminal.

 Note
The insulating plate CPX-P-AB-IP must be mounted between a module in intrinsically safe design (CPX-P-8DE-N-IS) and another, non-intrinsically safe CPX input or output module.

 Note
The above-mentioned certifications for the CPX-P-8DE-N-IS module do not apply if the module is used outside the appropriately configured terminal CPX-P.

Materials	
Housing	PA reinforced
	PC
Note on materials	RoHS-compliant

Operating and environmental conditions			
Type		CPX-P-8DE-N	CPX-P-8DE-N-IS
Ambient temperature	[°C]	–5 ... +50	–5 ... +50
Storage temperature	[°C]	–20 ... +70	–20 ... +70
Relative air humidity	[%]	95, non-condensing	95, non-condensing
CE marking (see declaration of conformity)		To EU EMC Directive ¹⁾	–
		–	To EU Explosion Protection Directive (ATEX)

1) For information about the applicability of the component see the manufacturer's EC declaration of conformity at: www.festo.com/sp → User documentation.
If the component is subject to restrictions on usage in residential, office or commercial environments or small businesses, further measures to reduce the emitted interference may be necessary.

Terminal CPX-P

Technical data – Input module, digital, NAMUR

Connection and display components

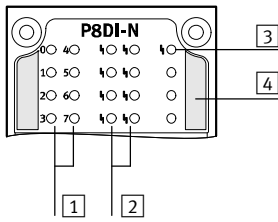

- 1 Status LEDs (green)
For allocation to inputs
→ Pin allocation for module
- 2 Channel-related error LEDs (red)
- 3 Error LED (red, module error)
- 4 Marking for intrinsically safe variant, CPX-P-8DE-N-IS (blue)

Connection block/digital input module combinations





Connection blocks	Part No.	Digital input module	
		CPX-P-8DE-N	CPX-P-8DE-N-IS
CPX-P-AB-4XM12-4POL	565706	■	-
CPX-P-AB-2XKL-8POL	565704	■	-
CPX-P-AB-4XM12-4POL-8DE-N-IS	565705	-	■
CPX-P-AB-2XKL-8POL-8DE-N-IS	565703	-	■

Pin allocation

Connection block outputs	CPX-P-8DE-N and CPX-P-8DE-N-IS	
CPX-P-AB-4XM12-4POL and CPX-P-AB-4XM12-4POL-8DE-N-IS		
	<p>X1.1: BN+ [0] X1.2: BU- [0] X1.3: BN+ [1] X1.4: BU- [1]</p> <p>X2.1: BN+ [2] X2.2: BU- [2] X2.3: BN+ [3] X2.4: BU- [3]</p>	<p>X3.1: BN+ [4] X3.2: BU- [4] X3.3: BN+ [5] X3.4: BU- [5]</p> <p>X4.1: BN+ [6] X4.2: BU- [6] X4.3: BN+ [7] X4.4: BU- [7]</p>
CPX-P-AB-2XKL-8POL and CPX-P-AB-2XKL-8POL-8DE-N-IS		
	<p>X1.1: BN+ [0] X1.2: BU- [0] X1.3: BN+ [1] X1.4: BU- [1]</p> <p>X1.5: BN+ [2] X1.6: BU- [2] X1.7: BN+ [3] X1.8: BU- [3]</p>	<p>X2.1: BN+ [4] X2.2: BU- [4] X2.3: BN+ [5] X2.4: BU- [5]</p> <p>X2.5: BN+ [6] X2.6: BU- [6] X2.7: BN+ [7] X2.8: BU- [7]</p>

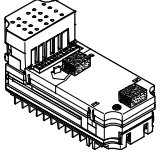
Terminal CPX-P

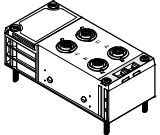
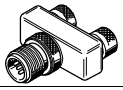
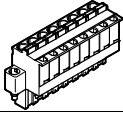
Technical data – Input module, digital, NAMUR

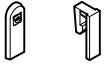
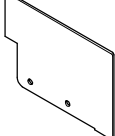
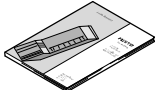
Ordering data						
Name				Part No.	Type	
Input module, digital, to NAMUR						
	8 digital inputs			565933	CPX-P-8DE-N	
	8 digital inputs, intrinsically safe design		 Note An intrinsically safe circuit may only be constructed using components and accessories approved for intrinsically safe operation.	565934	CPX-P-8DE-N-IS	
Connection block						
	Plastic	4x socket, M12, 4-pin	For non-intrinsically safe design	565706	CPX-P-AB-4XM12-4POL	
			For intrinsically safe design	565705	CPX-P-AB-4XM12-4POL-8DE-N-IS	
		2x plug, 8-pin	For non-intrinsically safe design	565704	CPX-P-AB-2XKL-8POL	
			For intrinsically safe design	565703	CPX-P-AB-2XKL-8POL-8DE-N-IS	
Plug						
	Push-in T-connector	1x plug M12, 4-pin	2x socket M12, 4-pin	562248	NEDU-M12D4-M12T4-IS¹⁾	
	Socket	8-pin	Spring-loaded terminal	Black	565712	NECU-L3G8-C1
				Gentian blue	565711	NECU-L3G8-C1-IS¹⁾
			Screw terminal	Black	565710	NECU-L3G8-C2
				Gentian blue	565709	NECU-L3G8-C2-IS¹⁾
	Plug, M12, 4-pin	Spring-loaded terminal	For cable Ø 4 ... 8 mm		575719	NECU-M-S-A12G4-IS¹⁾
			Screw terminal	For cable Ø 2.5 ... 2.9 mm		570955
		For cable Ø 4 ... 6 mm		570953	NECU-S-M12G4-P1-IS¹⁾	
		For cable Ø 6 ... 8 mm		570954	NECU-S-M12G4-P2-IS¹⁾	
		For cable Ø 2x3 mm or 2x5 mm		570956	NECU-S-M12G4-D-IS¹⁾	
Cover						
	Cover cap for sealing unused connections (10 pieces)		For M12 connections	165592	ISK-M12	
Coding element						
	Ensures that a coded socket NECU-L3G8 can only be inserted in the matching coded connection block CPX-P-AB-2XKL (96 pieces of each)		For NECU-L3G8	565713	CPX-P-KDS-AB-2XKL	
Screening plate						
	Insulating plate for safe separation of intrinsically safe and non-intrinsically safe areas of the CPX terminal			565708	CPX-P-AB-IP	
User documentation						
	User documentation			German	575378	P.BE-CPX-P-EA-DE
				English	575379	P.BE-CPX-P-EA-EN
				Spanish	575380	P.BE-CPX-P-EA-ES
				French	575381	P.BE-CPX-P-EA-FR
				Italian	575382	P.BE-CPX-P-EA-IT
				Swedish	575383	P.BE-CPX-P-EA-SV

1) Component preferred for operation in intrinsically safe circuits.

Terminal CPX-P

Technical data – Input module, digital, 16 inputs

Function

Digital input modules enable the connection of two-wire and three-wire sensors (proximity sensors, inductive or capacitive sensors, etc.).

Depending on the connection block selected, the module supports various connection concepts with different numbers of sockets (single or double allocation).

Applications

- Input modules for 24 V DC sensor supply voltage
- PNP logic
- Module features can be parameterised
- The input module receives the voltage supply for the electronics and the sensors from the interlinking block
- Module protection and diagnostics through integrated electronic fuse protection



General technical data		
Number of inputs		16
Max. residual current of inputs per module	[A]	1.8
Intrinsic current consumption at operating voltage	[mA]	Typically 15
Fuse protection		Internal electronic fuse for each module
Nominal operating voltage	[V DC]	24
Operating voltage range	[V DC]	18 ... 30
Electrical isolation	Channel – channel	No
	Channel – internal bus	No
Switching level	Signal 0	[V DC] ≤ 5
	Signal 1	[V DC] ≥ 11
Input debounce time	[ms]	3 (0.1 ms, 10 ms, 20 ms parameterisable)
Input characteristic		IEC 1131-T2
Switching logic		Positive logic (PNP)
LED displays	Group diagnostics	1
	Channel diagnostics	–
	Channel status	16
Diagnostics		Short circuit/overload per channel
Parameterisation		<ul style="list-style-type: none"> • Module monitoring • Behaviour after short circuit • Input debounce time • Signal extension time
Protection class to EN 60529		Depending on connection block
Temperature range	Operation	[°C] –5 ... +50
	Storage/transport	[°C] –20 ... +70
Materials		PA reinforced, PC
Grid dimension	[mm]	50
Dimensions (incl. interlinking block and connection block) W x L x H	[mm]	50 x 107 x 50
Product weight	[g]	38

Terminal CPX-P

Technical data – Input module, digital, 16 inputs

Connection and display components

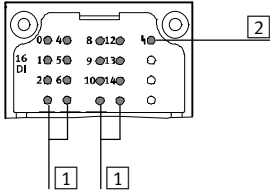

- 1 Status LEDs (green)
For allocation to inputs
→ Pin allocation for module
- 2 Error LED (red, module error)

Connection block/digital input module combinations

Connection blocks	Part No.	Digital input modules	
		CPX-16DE	
CPX-AB-8-M8X2-4POL	541256		■
CPX-AB-8-KL-4POL	195708		■
CPX-AB-1-SUB-BU-25POL	525676		■

Pin allocation

Connection block inputs	CPX-16DE																																						
CPX-AB-8-M8x2-4POL																																							
	<table border="0"> <tr> <td>X1.1: 24 V_{SEN}</td> <td>X5.1: 24 V_{SEN}</td> </tr> <tr> <td>X1.2: Input x+1</td> <td>X5.2: Input x+9</td> </tr> <tr> <td>X1.3: 0 V_{SEN}</td> <td>X5.3: 0 V_{SEN}</td> </tr> <tr> <td>X1.4: Input x</td> <td>X5.4: Input x+8</td> </tr> <tr> <td> </td> <td> </td> </tr> <tr> <td>X2.1: 24 V_{SEN}</td> <td>X6.1: 24 V_{SEN}</td> </tr> <tr> <td>X2.2: Input x+3</td> <td>X6.2: Input x+11</td> </tr> <tr> <td>X2.3: 0 V_{SEN}</td> <td>X6.3: 0 V_{SEN}</td> </tr> <tr> <td>X2.4: Input x+2</td> <td>X6.4: Input x+10</td> </tr> <tr> <td> </td> <td> </td> </tr> <tr> <td>X3.1: 24 V_{SEN}</td> <td>X7.1: 24 V_{SEN}</td> </tr> <tr> <td>X3.2: Input x+5</td> <td>X7.2: Input x+13</td> </tr> <tr> <td>X3.3: 0 V_{SEN}</td> <td>X7.3: 0 V_{SEN}</td> </tr> <tr> <td>X3.4: Input x+4</td> <td>X7.4: Input x+12</td> </tr> <tr> <td> </td> <td> </td> </tr> <tr> <td>X4.1: 24 V_{SEN}</td> <td>X8.1: 24 V_{SEN}</td> </tr> <tr> <td>X4.2: Input x+7</td> <td>X8.1: Input x+15</td> </tr> <tr> <td>X4.3: 0 V_{SEN}</td> <td>X8.3: 0 V_{SEN}</td> </tr> <tr> <td>X4.4: Input x+6</td> <td>X8.4: Input x+14</td> </tr> </table>	X1.1: 24 V _{SEN}	X5.1: 24 V _{SEN}	X1.2: Input x+1	X5.2: Input x+9	X1.3: 0 V _{SEN}	X5.3: 0 V _{SEN}	X1.4: Input x	X5.4: Input x+8	 	 	X2.1: 24 V _{SEN}	X6.1: 24 V _{SEN}	X2.2: Input x+3	X6.2: Input x+11	X2.3: 0 V _{SEN}	X6.3: 0 V _{SEN}	X2.4: Input x+2	X6.4: Input x+10	 	 	X3.1: 24 V _{SEN}	X7.1: 24 V _{SEN}	X3.2: Input x+5	X7.2: Input x+13	X3.3: 0 V _{SEN}	X7.3: 0 V _{SEN}	X3.4: Input x+4	X7.4: Input x+12	 	 	X4.1: 24 V _{SEN}	X8.1: 24 V _{SEN}	X4.2: Input x+7	X8.1: Input x+15	X4.3: 0 V _{SEN}	X8.3: 0 V _{SEN}	X4.4: Input x+6	X8.4: Input x+14
X1.1: 24 V _{SEN}	X5.1: 24 V _{SEN}																																						
X1.2: Input x+1	X5.2: Input x+9																																						
X1.3: 0 V _{SEN}	X5.3: 0 V _{SEN}																																						
X1.4: Input x	X5.4: Input x+8																																						
X2.1: 24 V _{SEN}	X6.1: 24 V _{SEN}																																						
X2.2: Input x+3	X6.2: Input x+11																																						
X2.3: 0 V _{SEN}	X6.3: 0 V _{SEN}																																						
X2.4: Input x+2	X6.4: Input x+10																																						
X3.1: 24 V _{SEN}	X7.1: 24 V _{SEN}																																						
X3.2: Input x+5	X7.2: Input x+13																																						
X3.3: 0 V _{SEN}	X7.3: 0 V _{SEN}																																						
X3.4: Input x+4	X7.4: Input x+12																																						
X4.1: 24 V _{SEN}	X8.1: 24 V _{SEN}																																						
X4.2: Input x+7	X8.1: Input x+15																																						
X4.3: 0 V _{SEN}	X8.3: 0 V _{SEN}																																						
X4.4: Input x+6	X8.4: Input x+14																																						

Terminal CPX-P



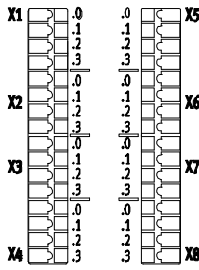
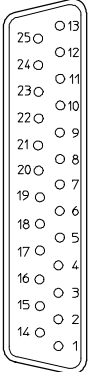



Technical data – Input module, digital, 16 inputs

Pin allocation		
Connection block inputs	CPX-16DE	
CPX-AB-8-KL-4POL		
	<p>X1.0: Input x+8 X1.1: 24 V_{SEN} X1.2: Input x X1.3: FE</p> <p>X2.0: Input x+9 X2.1: 24 V_{SEN} X2.2: Input x+1 X2.3: FE</p> <p>X3.0: Input x+10 X3.1: 24 V_{SEN} X3.2: Input x+2 X3.3: FE</p> <p>X4.0: Input x+11 X4.1: 24 V_{SEN} X4.2: Input x+3 X4.3: FE</p>	<p>X5.0: Input x+12 X5.1: 0 V_{SEN} X5.2: Input x+4 X5.3: FE</p> <p>X6.0: Input x+13 X6.1: 0 V_{SEN} X6.2: Input x+5 X6.3: FE</p> <p>X7.0: Input x+14 X7.1: 0 V_{SEN} X7.2: Input x+6 X7.3: FE</p> <p>X8.0: Input x+15 X8.1: 0 V_{SEN} X8.2: Input x+7 X8.3: FE</p>
CPX-AB-1-SUB-BU-25POL		
	<p>1: Input x 2: Input x+1 3: Input x+2 4: Input x+3 5: Input x+9 6: 24 V_{SEN} 7: Input x+11 8: 24 V_{SEN} 9: Input x+8 10: Input x+10 11: 24 V_{SEN} 12: 24 V_{SEN} 13: FE</p>	<p>14: Input x+4 15: Input x+5 16: Input x+6 17: Input x+7 18: Input x+12 19: Input x+13 20: Input x+14 21: Input x+15 22: 0 V_{SEN} 23: 0 V_{SEN} 24: 0 V_{SEN} 25: FE Housing: FE</p>

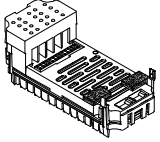
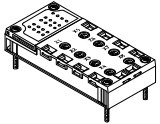
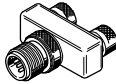
Terminal CPX-P

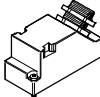
FESTO

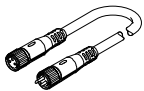
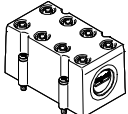
Technical data – Input module, digital, 16 inputs

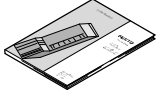
Ordering data					
Designation			Part No.	Type	
Input module, digital					
	16 digital inputs, internal electronic fuse for each module		543815	CPX-16DE	
Connection block					
	Plastic	8x socket, M8, 4-pin	541256	CPX-AB-8-M8X2-4POL	
		Spring-loaded terminal, 32-pin	195708	CPX-AB-8-KL-4POL	
		1x socket, Sub-D, 25-pin	525676	CPX-AB-1-SUB-BU-25POL	
Plug					
	Push-in T-connector	1x plug M8, 4-pin	2x socket M8, 3-pin	544391	NEDU-M8D3-M8T4
	For NEDU-M8D3-M8T4	M8, 3-pin	Solderable	18696	SEA-GS-M8
			Screw-in	192009	SEA-3GS-M8-S
	Sub-D plug, 25-pin		527522	SD-SUB-D-ST25	
Connecting cable					
	For NEDU-M8D3-M8T4	1x socket M8, 3-pin 1x plug M8, 3-pin	0.5 m	175488	KM8-M8-GSGD-0,5
			1.0 m	175489	KM8-M8-GSGD-1
			2.5 m	165610	KM8-M8-GSGD-2,5
			5.0 m	165611	KM8-M8-GSGD-5
	Modular system for connecting cables		-	NEBU-...	→ Internet: nebu
Cover					
	Hood for CPX-AB-8-KL-4POL (IP65/67)	8 cable through-feeds M9 1 cable through-feed for multi-pin plug	538219	AK-8KL	
	Fittings kit for hood AK-8KL		538220	VG-K-M9	
	Cover cap for sealing unused M8 connections (10 pieces)		177672	ISK-M8	
User documentation					
	User documentation	German	526439	P.BE-CPX-EA-DE	
		English	526440	P.BE-CPX-EA-EN	
		Spanish	526441	P.BE-CPX-EA-ES	
		French	526442	P.BE-CPX-EA-FR	
		Italian	526443	P.BE-CPX-EA-IT	
		Swedish	526444	P.BE-CPX-EA-SV	

Terminal CPX-P

Technical data – Analogue module for inputs

Function

Analogue modules control devices with a standardised analogue interface such as sensors for pressure, temperature, flow rate, filling level, etc.

Depending on the connection block selected, the analogue module supports various connection concepts with different numbers of sockets or terminals.

Applications

- Analogue module for 0 ... 10 V, 0 ... 20 mA or 4 ... 20 mA
- Supports connection blocks with M12, Sub-D and terminal connection
- Analogue module features can be parameterised
- Different data formats available
- Operation with and without galvanic isolation possible
- The analogue module receives the voltage supply for the electronics and the sensors from the interlinking block
- Analogue module protection and diagnostics through integrated electronic fuse protection



General technical data		
Type	CPX-4AE-U-I	
	Voltage input	Current input
Number of analogue inputs	4	
Max. power supply per module [A]	0.7	
Fuse protection	Internal electronic fuse	
Current consumption from 24 V sensor supply (quiescent current) [mA]	Typically 50	
Current consumption from 24 V sensor supply (at full load) [A]	Max. 0.7	
Nominal operating voltage, load voltage [V DC]	24 ±2%	
Nominal operating voltage [V DC]	24	
Operating voltage range [V DC]	18 ... 30	
Signal range (parameterisable for each channel by means of DIL switch or software)	1 ... 5 V 0 ... 10 V -5 ... +5 V -10 ... +10 V	0 ... 20 mA 4 ... 20 mA -20 ... +20 mA
Operational error limit [%]	±0.3	±0.3
Basic error limit (at 25 °C) [%]	±0.2	±0.2
Repetition accuracy (at 25 °C) [%]	0.1	0.1
Input resistance	100 kΩ	≤ 100 Ω
Max. permissible input voltage [V DC]	-30 ... +30	-
Max. permissible input current [mA]	-	Internally limited to 60
Conversion time per channel [µs]	Typically 150	
Cycle time (module) [ms]	≤ 0.5	
Data format	15 bits + prefix Scalable to 15 bits	
Cable length [m]	Max. 30 (screened)	

Terminal CPX-P

Technical data – Analogue module for inputs

General technical data			
Electrical isolation	Channel – channel	No	
	Channel – internal bus	Yes, with external sensor supply	
LED displays	Group diagnostics	1	
	Channel diagnostics	4	
Diagnostics	Wire break per channel		
	Limit value violation per channel		
	Parameterisation error		
	Overload at input		
	Overflow/underflow		
	Short circuit in sensor supply		
Parameterisation	Data format		
	Forces per channel		
	Limit value monitoring per channel		
	Measured value smoothing		
	Signal range per channel		
	Wire break monitoring per channel		
	Behaviour after short circuit		
	Behaviour after overload at input		
Sensor supply active			
Protection class to EN 60529		Depending on connection block	
Temperature range	Operation	[°C]	-5 ... +50
	Storage/transport	[°C]	-20 ... +70
Materials			PA reinforced, PC
Note on materials			RoHS-compliant
Grid dimension		[mm]	50
Dimensions (incl. interlinking block and connection block) W x L x H		[mm]	50 x 107 x 50
Product weight		[g]	46

Internal structure, basic representation

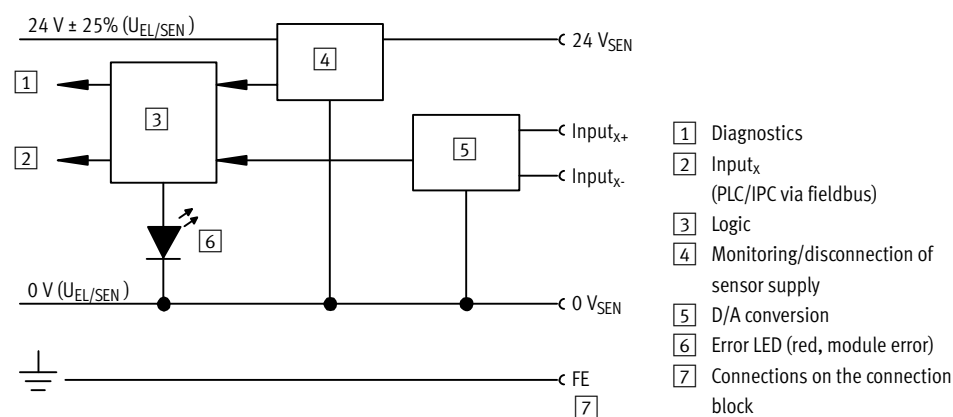

Terminal CPX-P

Technical data – Analogue module for inputs

Connection and display components

CPX-4AE-U-I

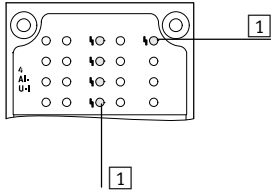

- 1 Error LED (red, module error)
- 2 Channel-related error LEDs (red)

Connection block/analogue module combinations

Connection blocks	Part No.	Analogue module	
			CPX-4AE-U-I
CPX-AB-4-M12X2-5POL	195704		■
CPX-AB-4-M12X2-5POL-R	541254		■
CPX-AB-8-KL-4POL	195708		■
CPX-AB-1-SUB-BU-25POL	525676		■
CPX-M-AB-4-M12X2-5POL	549367		■

Pin allocation

Connection block inputs	CPX-4AE-U-I	
CPX-AB-4-M12X2-5POL, CPX-AB-4-M12X2-5POL-R ¹⁾ and CPX-M-AB-4-M12X2-5POL		
	<p>X1.1: 24 V_{SEN}</p> <p>X1.2: Input 0+</p> <p>X1.3: 0 V_{SEN}</p> <p>X1.4: Input 0-</p> <p>X1.5: FE²⁾</p> <p>X2.1: 24 V_{SEN}</p> <p>X2.2: Input 1+</p> <p>X2.3: 0 V_{SEN}</p> <p>X2.4: Input 1-</p> <p>X2.5: FE²⁾</p>	<p>X3.1: 24 V_{SEN}</p> <p>X3.2: Input 2+</p> <p>X3.3: 0 V_{SEN}</p> <p>X3.4: Input 2-</p> <p>X3.5: FE²⁾</p> <p>X4.1: 24 V_{SEN}</p> <p>X4.2: Input 3+</p> <p>X4.3: 0 V_{SEN}</p> <p>X4.4: Input 3-</p> <p>X4.5: FE²⁾</p>
CPX-AB-8-KL-4POL		
	<p>X1.0: 24 V_{SEN}</p> <p>X1.1: 0 V_{SEN}</p> <p>X1.2: Input 0-</p> <p>X1.3: FE</p> <p>X2.0: n.c.</p> <p>X2.1: n.c.</p> <p>X2.2: Input 0+</p> <p>X2.3: FE</p> <p>X3.0: 24 V_{SEN}</p> <p>X3.1: 0 V_{SEN}</p> <p>X3.2: Input 1-</p> <p>X3.3: FE</p> <p>X4.0: n.c.</p> <p>X4.1: n.c.</p> <p>X4.2: Input 1+</p> <p>X4.3: FE</p>	<p>X5.0: 24 V_{SEN}</p> <p>X5.1: 0 V_{SEN}</p> <p>X5.2: Input 2-</p> <p>X5.3: FE</p> <p>X6.0: n.c.</p> <p>X6.1: n.c.</p> <p>X6.2: Input 2+</p> <p>X6.3: FE</p> <p>X7.0: 24 V_{SEN}</p> <p>X7.1: 0 V_{SEN}</p> <p>X7.2: Input 3-</p> <p>X7.3: FE</p> <p>X8.0: n.c.</p> <p>X8.1: n.c.</p> <p>X8.2: Input 3+</p> <p>X8.3: FE</p>

1) Speedcon quick lock, screening additionally on metal thread

2) FE/screening additionally on metal thread

Terminal CPX-P



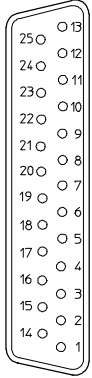



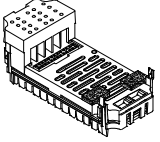
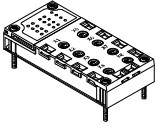

Technical data – Analogue module for inputs

Pin allocation		
Connection block inputs	CPX-4AE-U-I	
CPX-AB-1-SUB-BU-25POL		
	1: Input 0- 2: Input 0+ 3: Input 1- 4: Input 1+ 5: n.c. 6: n.c. 7: n.c. 8: n.c. 9: 24 V _{SEN} 10: 24 V _{SEN} 11: 0 V _{SEN} 12: 0 V _{SEN} 13: Screening ¹⁾	14: Input 2- 15: Input 2+ 16: Input 3- 17: Input 3+ 18: 24 V _{SEN} 19: n.c. 20: 24 V _{SEN} 21: n.c. 22: 0 V _{SEN} 23: 0 V _{SEN} 24: 0 V _{SEN} 25: FE Housing: FE

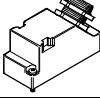
1) Connect screening to functional earth FE

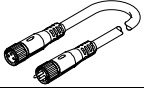
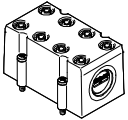
Terminal CPX-P

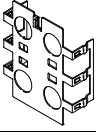
Technical data – Analogue module for inputs

Ordering data						
Designation				Part No.	Type	
Input module, analogue						
	4 analogue current or voltage inputs			573710	CPX-4AE-U-I	
Connection block						
	Plastic	4x socket, M12, 5-pin		195704	CPX-AB-4-M12X2-5POL	
		4x socket, M12 with quick-lock technology, 5-pin		541254	CPX-AB-4-M12X2-5POL-R	
		Spring-loaded terminal, 32-pin		195708	CPX-AB-8-KL-4POL	
		1x socket, Sub-D, 25-pin		525676	CPX-AB-1-SUB-BU-25POL	
	Metal	4x socket, M12, 5-pin		549367	CPX-M-AB-4-M12X2-5POL	
Plug						
	Plug	M12, 5-pin	PG7, for cable Ø 4 ... 6 mm	175487	SEA-M12-5GS-PG7	
	Sub-D plug, 25-pin			527522	SD-SUB-D-ST25	
Connecting cable						
	Connecting cable	1x socket, M12, 5-pin 1x plug, M12, 5-pin	2.5 m	18684	KM12-M12-GSGD-2,5	
			5.0 m	18686	KM12-M12-GSGD-5	
			1.0 m	185499	KM12-M12-GSWD-1-4	
	Modular system for connecting cables			–	NEBU... → Internet: nebu	
Cover						
	Hood for CPX-AB-8-KL-4POL (IP65/67)		8 cable through-feeds M9 1 cable through-feed for multi-pin plug	538219	AK-8KL	
	Fittings kit for hood AK-8KL			538220	VG-K-M9	
	Cover cap for sealing unused M12 connections (10 pieces)			165592	ISK-M12	
Screening plate						
	Screening plate for connection block • CPX-AB-4-M12X2-5POL • CPX-AB-4-M12X2-5POL-R			526184	CPX-AB-S-4-M12	
User documentation						
	User documentation			German	526415	P.BE-CPX-AX-DE
				English	526416	P.BE-CPX-AX-EN
				Spanish	526417	P.BE-CPX-AX-ES
				French	526418	P.BE-CPX-AX-FR
				Italian	526419	P.BE-CPX-AX-IT
				Swedish	526420	P.BE-CPX-AX-SV

Terminal CPX-P

Technical data – Output module, digital

Function

Digital outputs control actuators such as individual valves, hydraulic valves, heating controllers and many more. Separate circuits are created using an additional power supply. Parallel connection of the outputs of a module enables consuming devices to be controlled with up to 4 A.

Applications

- Output module for 24 V DC supply voltage
- PNP logic
- Module features can be parameterised
- The output module receives the voltage supply for the electronics and the outputs from the interlinking block
- Module protection and diagnostics through integrated electronic fuse protection in each channel



General technical data				
Type		CPX-4DA	CPX-8DA	
Number of outputs		4	8	
Max. power supply	Per module	[A]	4	
	Per channel	[A]	1 (24 W lamp load, 4 channels can be connected in parallel)	0.5 (12 W lamp load, 8 channels can be connected in parallel)
Fuse protection (short circuit)		Internal electronic fuse for each channel		
Module current consumption (voltage supply for electronics)		[mA]	Typically 16	
Operating voltage	Nominal value	[V DC]	24	
	Permissible range	[V DC]	18 ... 30	
Electrical isolation	Channel – channel		No	
	Channel – internal bus		Yes, using an intermediate supply	
Output characteristic curve		To IEC 1131-2		
Switching logic		Positive logic (PNP)		
LED displays	Group diagnostics		1	1
	Channel diagnostics		4	8
	Channel status		4	8
Diagnostics		<ul style="list-style-type: none"> • Short circuit/overload, channel x • Undervoltage of outputs 		
Parameterisation		<ul style="list-style-type: none"> • Module monitoring • Behaviour after short circuit • Fail-safe channel x • Forcing channel x • Idle mode channel x 		
Protection class to EN 60529		Depending on connection block		
Temperature range	Operation	[°C]	–5 ... +50	
	Storage/transport	[°C]	–20 ... +70	
Materials		PA reinforced, PC		
Grid dimension		[mm]	50	
Dimensions (incl. interlinking block and connection block) W x L x H		[mm]	50 x 107 x 50	
Product weight		[g]	38	

Terminal CPX-P

Technical data – Output module, digital

Connection and display components

CPX-4DA

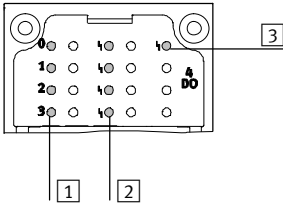

CPX-8DA

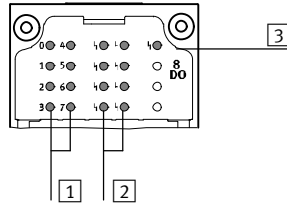

- 1 Status LEDs (yellow)
For allocation to outputs
→ Pin allocation for module
- 2 Channel-related error LEDs (red)
- 3 Error LED (red, module error)

Connection block/digital output module combinations

Connection blocks	Part No.	Digital output module	
		CPX-4DA	CPX-8DA
CPX-AB-8-M8-3POL	195706	■	■
CPX-AB-8-M8X2-4POL	541256	■	■
CPX-AB-4-M12X2-5POL	195704	■	■
CPX-AB-4-M12X2-5POL-R	541254	■	■
CPX-AB-8-KL-4POL	195708	■	■
CPX-AB-1-SUB-BU-25POL	525676	■	■
CPX-AB-4-HAR-4POL	525636	■	■
CPX-M-AB-4-M12X2-5POL	549367	■	■

Pin allocation

Connection block outputs	CPX-4DA	CPX-8DA
CPX-AB-8-M8-3POL		
	<p>X1.1: n.c. X1.3: 0 V_{OUT} X1.4: Output x</p> <p>X2.1: n.c. X2.3: 0 V_{OUT} X2.4: Output x+1</p> <p>X3.1: n.c. X3.3: 0 V_{OUT} X3.4: Output x+1</p> <p>X4.1: n.c. X4.3: 0 V_{OUT} X4.4: n.c.</p>	<p>X5.1: n.c. X5.3: 0 V_{OUT} X5.4: Output x+2</p> <p>X6.1: n.c. X6.3: 0 V_{OUT} X6.4: Output x+3</p> <p>X7.1: n.c. X7.3: 0 V_{OUT} X7.4: Output x+3</p> <p>X8.1: n.c. X8.3: 0 V_{OUT} X8.4: n.c.</p>

Terminal CPX-P

Technical data – Output module, digital



Pin allocation					
Connection block outputs		CPX-4DA		CPX-8DA	
CPX-AB-8-M8X2-4POL					
		X1.1: 0 V _{OUT} X1.2: Output x+1 X1.3: 0 V _{OUT} X1.4: Output x X2.1: 0 V _{OUT} X2.2: n.c. X2.3: 0 V _{OUT} X2.4: Output x+1 X3.1: 0 V _{OUT} X3.2: Output x+3 X3.3: 0 V _{OUT} X3.4: Output x+2 X4.1: 0 V _{OUT} X4.2: n.c. X4.3: 0 V _{OUT} X4.4: Output x+3	X5.1: 0 V _{OUT} X5.2: n.c. X5.3: 0 V _{OUT} X5.4: n.c. X6.1: 0 V _{OUT} X6.2: n.c. X6.3: 0 V _{OUT} X6.4: n.c. X7.1: 0 V _{OUT} X7.2: n.c. X7.3: 0 V _{OUT} X7.4: n.c. X8.1: 0 V _{OUT} x+1 X8.2: n.c. X8.3: 0 V _{OUT} x+3 X8.4: n.c.	X1.1: 0 V _{OUT} X1.2: Output x+1 X1.3: 0 V _{OUT} X1.4: Output x X2.1: 0 V _{OUT} X2.2: Output x+3 X2.3: 0 V _{OUT} X2.4: Output x+2 X3.1: 0 V _{OUT} X3.2: Output x+5 X3.3: 0 V _{OUT} X3.4: Output x+4 X4.1: 0 V _{OUT} X4.2: Output x+7 X4.3: 0 V _{OUT} X4.4: Output x+6	X5.1: 0 V _{OUT} X5.2: n.c. X5.3: 0 V _{OUT} X5.4: n.c. X6.1: 0 V _{OUT} X6.2: n.c. X6.3: 0 V _{OUT} X6.4: n.c. X7.1: 0 V _{OUT} X7.2: n.c. X7.3: 0 V _{OUT} X7.4: n.c. X8.1: 0 V _{OUT} X8.2: n.c. X8.3: 0 V _{OUT} X8.4: n.c.
CPX-AB-4-M12X2-5POL and CPX-AB-4-M12X2-5POL-R¹⁾					
		X1.1: n.c. X1.2: Output x+1 X1.3: 0 V _{OUT} X1.4: Output x X1.5: FE X2.1: n.c. X2.2: n.c. X2.3: 0 V _{OUT} X2.4: Output x+1 X2.5: FE	X3.1: n.c. X3.2: Output x+3 X3.3: 0 V _{OUT} X3.4: Output x+2 X3.5: FE X4.1: n.c. X4.2: n.c. X4.3: 0 V _{OUT} X4.4: Output x+3 X4.5: FE	X1.1: n.c. X1.2: Output x+1 X1.3: 0 V _{OUT} X1.4: Output x X1.5: FE X2.1: n.c. X2.2: Output x+3 X2.3: 0 V _{OUT} X2.4: Output x+2 X2.5: FE	X3.1: n.c. X3.2: Output x+5 X3.3: 0 V _{OUT} X3.4: Output x+4 X3.5: FE X4.1: n.c. X4.2: Output x+7 X4.3: 0 V _{OUT} X4.4: Output x+6 X4.5: FE
CPX-AB-8-KL-4POL					
		X1.0: n.c. X1.1: 0 V _{OUT} X1.2: Output x X1.3: FE X2.0: n.c. X2.1: 0 V _{OUT} X2.2: Output x+1 X2.3: FE X3.0: n.c. X3.1: 0 V _{OUT} X3.2: Output x+1 X3.3: FE X4.0: n.c. X4.1: 0 V _{OUT} X4.2: n.c. X4.3: FE	X5.0: n.c. X5.1: 0 V _{OUT} X5.2: Output x+2 X5.3: FE X6.0: n.c. X6.1: 0 V _{OUT} X6.2: Output x+3 X6.3: FE X7.0: n.c. X7.1: 0 V _{OUT} X7.2: Output x+3 X7.3: FE X8.0: n.c. X8.1: 0 V _{OUT} X8.2: n.c. X8.3: FE	X1.0: n.c. X1.1: 0 V _{OUT} X1.2: Output x X1.3: FE X2.0: n.c. X2.1: 0 V _{OUT} X2.2: Output x+1 X2.3: FE X3.0: n.c. X3.1: 0 V _{OUT} X3.2: Output x+2 X3.3: FE X4.0: n.c. X4.1: 0 V _{OUT} X4.2: Output x+3 X4.3: FE	X5.0: n.c. X5.1: 0 V _{OUT} X5.2: Output x+4 X5.3: FE X6.0: n.c. X6.1: 0 V _{OUT} X6.2: Output x+5 X6.3: FE X7.0: n.c. X7.1: 0 V _{OUT} X7.2: Output x+6 X7.3: FE X8.0: n.c. X8.1: 0 V _{OUT} X8.2: Output x+7 X8.3: FE

1) Speedcon quick lock, screening additionally on metal thread

Terminal CPX-P



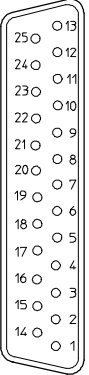
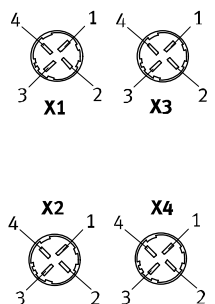

Technical data – Output module, digital

Pin allocation				
Connection block outputs	CPX-4DA		CPX-8DA	
CPX-AB-1-SUB-BU-25POL				
	1: Output x 2: Output x+1 3: Output x+1 4: n.c. 5: n.c. 6: 0 V _{OUT} 7: n.c. 8: 0 V _{OUT} 9: n.c. 10: n.c. 11: 0 V _{OUT} 12: 0 V _{OUT} 13: FE	14: Output x+2 15: Output x+3 16: Output x+3 17: n.c. 18: n.c. 19: n.c. 20: n.c. 21: n.c. 22: 0 V _{OUT} 23: 0 V _{OUT} 24: 0 V _{OUT} 25: FE Housing: FE	1: Output x 2: Output x+1 3: Output x+2 4: Output x+3 5: n.c. 6: 0 V _{OUT} 7: n.c. 8: 0 V _{OUT} 9: n.c. 10: n.c. 11: 0 V _{OUT} 12: 0 V _{OUT} 13: FE	14: Output x+4 15: Output x+5 16: Output x+6 17: Output x+7 18: n.c. 19: n.c. 20: n.c. 21: n.c. 22: 0 V _{OUT} 23: 0 V _{OUT} 24: 0 V _{OUT} 25: FE Housing: FE
CPX-AB-4-HAR-4POL				
	X1.1: n.c. X1.2: Output x+1 X1.3: 0 V _{OUT} X1.4: Output x X2.1: n.c. X2.2: n.c. X2.3: 0 V _{OUT} X2.4: Output x+1	X3.1: n.c. X3.2: Output x+3 X3.3: 0 V _{OUT} X3.4: Output x+2 X4.1: n.c. X4.2: n.c. X4.3: 0 V _{OUT} X4.4: Output x+3	X1.1: n.c. X1.2: Output x+1 X1.3: 0 V _{OUT} X1.4: Output x X2.1: n.c. X2.2: Output x+3 X2.3: 0 V _{OUT} X2.4: Output x+2	X3.1: n.c. X3.2: Output x+5 X3.3: 0 V _{OUT} X3.4: Output x+4 X4.1: n.c. X4.2: Output x+7 X4.3: 0 V _{OUT} X4.4: Output x+6

Terminal CPX-P

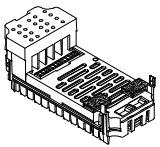
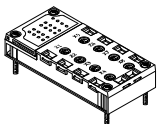
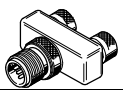
Technical data – Output module, digital

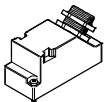
FESTO

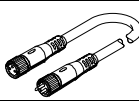
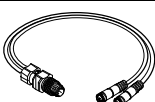
Ordering data					
Designation				Part No.	Type
Output module, digital					
	4 digital outputs, power supply 1 A per channel			195754	CPX-4DA
	8 digital outputs, power supply 0.5 A per channel			541482	CPX-8DA
Connection block					
	Plastic	8x socket, M8, 3-pin		195706	CPX-AB-8-M8-3POL
		8x socket, M8, 4-pin		541256	CPX-AB-8-M8X2-4POL
		4x socket, M12, 5-pin		195704	CPX-AB-4-M12X2-5POL
		4x socket, M12, 5-pin with quick-lock technology		541254	CPX-AB-4-M12X2-5POL-R
		Spring-loaded terminal, 32-pin		195708	CPX-AB-8-KL-4POL
		1x socket, Sub-D, 25-pin		525676	CPX-AB-1-SUB-BU-25POL
	Metal	4x socket, quick connector, 4-pin		525636	CPX-AB-4-HAR-4POL
		4x socket, M12, 5-pin	549367	CPX-M-AB-4-M12X2-5POL	
Plug					
	Push-in T-connector	1x plug, M8, 4-pin	2x socket, M8, 3-pin	544391	NEDU-M8D3-M8T4
		1x plug, M12, 4-pin	2x socket, M12, 5-pin	541596	NEDU-M12D5-M12T4
			2x socket, M8, 3-pin	541597	NEDU-M8D3-M12T4
	Plug	M8, 3-pin	Solderable	18696	SEA-GS-M8
			Screw-in	192009	SEA-3GS-M8-S
			Insulation displacement connector	0.1 ... 0.14 mm ²	564945
		0.14 ... 0.34 mm ²		562024	NECU-S-M8G3-HX
		M12, 4-pin	PG7, for cable Ø 4 ... 6 mm	18666	SEA-GS-7
			PG7, for cable Ø 2.5 ... 2.9 mm	192008	SEA-4GS-7-2,5
			PG9, for cable Ø 6 ... 8 mm	18778	SEA-GS-9
			PG11, for 2x cable Ø 3 ... 5 mm	18779	SEA-GS-11-DUO
M12, 5-pin	PG7, for cable Ø 4 ... 6 mm	175487	SEA-M12-5GS-PG7		
	PG11, for 2x cable Ø 2.5 ... 5 mm	192010	SEA-5GS-11-DUO		
	HARAX plug, 4-pin			525928	SEA-GS-HAR-4POL
	Sub-D plug, 25-pin			527522	SD-SUB-D-ST25
Connecting cable					
	Connecting cable	1x socket, M8, 3-pin 1x plug, M8, 3-pin	0.5 m	175488	KM8-M8-GSGD-0,5
			1.0 m	175489	KM8-M8-GSGD-1
			2.5 m	165610	KM8-M8-GSGD-2,5
			5.0 m	165611	KM8-M8-GSGD-5
		1x socket, M12, 5-pin 1x plug, M12, 5-pin	2.5 m	18684	KM12-M12-GSGD-2,5
			5.0 m	18686	KM12-M12-GSGD-5
		1.0 m	185499	KM12-M12-GSWD-1-4	
	Modular system for connecting cables			-	NEBU-... → Internet: nebu
	DUO cable M12	2x straight socket		18685	KM12-DUO-M8-GDGD
		2x straight/angled socket		18688	KM12-DUO-M8-GDWD
		2x angled socket		18687	KM12-DUO-M8-WDWD

Terminal CPX-P

Technical data – Output module, digital

Ordering data				
Designation			Part No.	Type
Cover				
	Hood for CPX-AB-8-KL-4POL (IP65/67)	8 cable through-feeds M9 1 cable through-feed for multi-pin plug	538219	AK-8KL
	Fittings kit for hood AK-8KL		538220	VG-K-M9
	Cover cap for sealing unused connections (10 pieces)	For M8 connections	177672	ISK-M8
		For M12 connections	165592	ISK-M12
Screening plate				
	Screening plate for connection block <ul style="list-style-type: none"> • CPX-AB-4-M12X2-5POL • CPX-AB-4-M12X2-5POL-R 		526184	CPX-AB-S-4-M12
User documentation				
	User documentation	German	526439	P.BE-CPX-EA-DE
		English	526440	P.BE-CPX-EA-EN
		Spanish	526441	P.BE-CPX-EA-ES
		French	526442	P.BE-CPX-EA-FR
		Italian	526443	P.BE-CPX-EA-IT
		Swedish	526444	P.BE-CPX-EA-SV

Terminal CPX-P

Technical data – Analogue module for outputs

Function

Analogue modules control devices with a standard analogue interface such as proportional valves, etc. The analogue module supports various connection concepts with different numbers of sockets or terminals as appropriate to the connection block selected.

Applications

- Analogue module for 0 ... 10 V, 0 ... 20 mA or 4 ... 20 mA
- Supports connection blocks with M12, Sub-D and terminal connection
- Analogue module features can be parameterised
- Different data formats available
- Operation with and without galvanic isolation possible
- The analogue module receives the voltage supply for the electronics and the actuators from the interlinking block
- Analogue module protection and diagnostics through integrated electronic fuse protection



General technical data				
Type		CPX-2AA-U-I		
		Voltage output	Current output	
Number of analogue outputs		2		
Max. actuator supply per module	[A]	2.8		
Fuse protection		Internal electronic fuse for actuator supply		
Current consumption from 24 V sensor supply (at full load)	[mA]	Max. 150		
Current consumption from 24 V actuator supply (at full load)	[A]	4 ... 10		
Supply voltage of actuators	[V DC]	24 ±25%		
Signal range (parameterisable for each channel by means of DIL switch or software)		0 ... 10 V DC	0 ... 20 mA 4 ... 2 mA	
Resolution	[bit]	12		
Number of units		4,096		
Absolute accuracy	[%]	±0.6		
Linearity errors (no software scaling)	[%]	±0.1		
Repetition accuracy (at 25 °C)	[%]	0.05		
Encoder selection	Load resistance for ohmic load	[kΩ]	Min. 1	Max. 0.5
	Load resistance for capacitive load	[μF]	Max. 1	–
	Load resistance for inductive load	[mH]	–	Max. 1
	Short circuit protection for analogue output		Yes	–
	Short circuit current of analogue output	[mA]	Approx. 20	–
	Open circuit voltage	[V DC]	–	18
	Destruction limit against externally applied voltage	[V DC]	15	
	Actuator connection		2 wires	
Cycle time (module)	[ms]	≤ 4		

Terminal CPX-P

Technical data – Analogue module for outputs

General technical data				
Type		CPX-2AA-U-I		
		Voltage output		Current output
Response time	For ohmic load	[ms]	0.1	0.1
	For capacitive load	[ms]	0.7	–
	For inductive load	[ms]	–	0.5
Data format		15 bits + prefix, linear scaling 12 bits right-justified 12 bits left-justified, S7 compatible 12 bits left-justified, S5 compatible		
Cable length		[m]	Max. 30 (screened)	
LED displays	Group diagnostics		1	
	Channel diagnostics		Yes, by means of flashing frequency of group diagnostics	
Diagnostics		<ul style="list-style-type: none"> • Short circuit/overload, actuator supply • Parameterisation error • Value falling below nominal range/full-scale value • Value exceeding nominal range/full-scale value • Wire break 		
Parameterisation		<ul style="list-style-type: none"> • Short circuit monitoring, actuator supply • Short circuit monitoring, analogue output • Behaviour after short circuit, actuator supply • Data format • Lower limit value/full-scale value • Upper limit value/full-scale value • Monitoring of value falling below nominal range/full-scale value • Monitoring of value exceeding nominal range/full-scale value • Wire break monitoring • Signal range 		
Protection class to EN 60529		Depending on connection block		
Temperature range	Operation		[°C]	–5 ... +50
	Storage/transport		[°C]	–20 ... +70
Materials		PA-reinforced PC		
Grid dimension		[mm]	50	
Dimensions (incl. interlinking block and connection block) W x L x H		[mm]	50 x 107 x 50	
Product weight		[g]	38	

Connection and display components

CPX-2AA-U-I

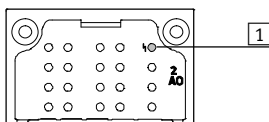

1 Error LED (red, module error)

Connection block/analogue module combinations			
Connection blocks	Part No.	Analogue module	
		CPX-2AA-U-I	
CPX-AB-4-M12X2-5POL	195704		■
CPX-AB-4-M12X2-5POL-R	541254		■
CPX-AB-8-KL-4POL	195708		■
CPX-AB-1-SUB-BU-25POL	525676		■
CPX-M-AB-4-M12X2-5POL	549367		■

Terminal CPX-P

Technical data – Analogue module for outputs

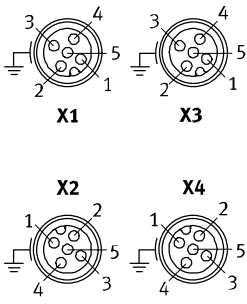
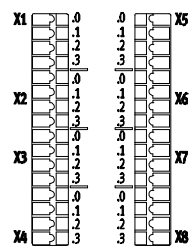
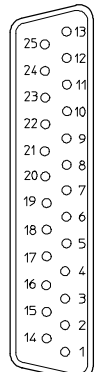



Pin allocation		
Connection block outputs	CPX-2AA-U-I	
CPX-AB-4-M12X2-5POL, CPX-AB-4-M12X2-5POL-R ¹⁾ , CPX-M-AB-4-M12X2-5POL		
	<p>X1.1: 24 V_{OUT} X1.2: Output U₀₊ X1.3: 0 V_{OUT} X1.4: Output GND X1.5: FE²⁾</p> <p>X2.1: 24 V_{OUT} X2.2: Output I₀₊ X2.3: 0 V_{OUT} X2.4: Output GND X2.5: FE²⁾</p>	<p>X3.1: 24 V_{OUT} X3.2: Output U₁₊ X3.3: 0 V_{OUT} X3.4: Output GND X3.5: FE²⁾</p> <p>X4.1: 24 V_{OUT} X4.2: Output I₁₊ X4.3: 0 V_{OUT} X4.4: Output GND X4.5: FE²⁾</p>
CPX-AB-8-KL-4POL		
	<p>X1.0: 24 V_{OUT} X1.1: 0 V_{OUT} X1.2: Output GND X1.3: FE</p> <p>X2.0: n.c. X2.1: n.c. X2.2: Output U₀₊ X2.3: FE</p> <p>X3.0: 24 V_{OUT} X3.1: 0 V_{OUT} X3.2: Output GND X3.3: FE</p> <p>X4.0: n.c. X4.1: n.c. X4.2: Output I₀₊ X4.3: FE</p>	<p>X5.0: 24 V_{OUT} X5.1: 0 V_{OUT} X5.2: Output GND X5.3: FE</p> <p>X6.0: n.c. X6.1: n.c. X6.2: Output U₁₊ X6.3: FE</p> <p>X7.0: 24 V_{OUT} X7.1: 0 V_{OUT} X7.2: Output GND X7.3: FE</p> <p>X8.0: n.c. X8.1: n.c. X8.2: Output I₁₊ X8.3: FE</p>
CPX-AB-1-SUB-BU-25POL		
	<p>1: Output GND 2: Output U₀₊ 3: Output GND 4: Output I₀₊ 5: n.c. 6: n.c. 7: n.c. 8: n.c. 9: 24 V_{OUT} 10: 24 V_{OUT} 11: 0 V_{OUT} 12: 0 V_{OUT} 13: Screening³⁾</p>	<p>14: Output GND 15: Output U₁₊ 16: Output GND 17: Output I₁₊ 18: 24 V_{OUT} 19: n.c. 20: 24 V_{OUT} 21: n.c. 22: 0 V_{OUT} 23: 0 V_{OUT} 24: 0 V_{OUT} 25: FE Housing: FE</p>

1) Speedcon quick lock, screening additionally on metal thread
 2) FE/screening additionally on metal thread
 3) Connect screening to functional earth FE

Terminal CPX-P

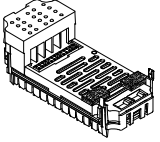
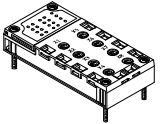
Technical data – Analogue module for outputs

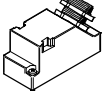
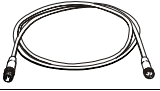
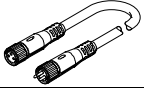
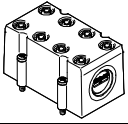
FESTO

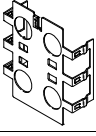
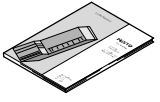
Ordering data					
Designation				Part No.	Type
Output module, analogue					
	2 analogue current or voltage outputs			526170	CPX-2AA-U-I
Connection block					
	Plastic	4x socket, M12, 5-pin		195704	CPX-AB-4-M12X2-5POL
		4x socket, M12 with quick-lock technology, 5-pin		541254	CPX-AB-4-M12X2-5POL-R
		Spring-loaded terminal, 32-pin		195708	CPX-AB-8-KL-4POL
		1x socket, Sub-D, 25-pin		525676	CPX-AB-1-SUB-BU-25POL
	Metal	4x socket, M12, 5-pin		549367	CPX-M-AB-4-M12X2-5POL
Plug					
	Plug	M12, 5-pin	PG7, for cable Ø 4 ... 6 mm	175487	SEA-M12-5GS-PG7
	Sub-D plug, 25-pin			527522	SD-SUB-D-ST25
Connecting cable					
	Connecting cable	1x socket, M12, 5-pin 1x plug, M12, 5-pin	2.5 m	18684	KM12-M12-GSGD-2,5
			5.0 m	18686	KM12-M12-GSGD-5
			1.0 m	185499	KM12-M12-GSWD-1-4
	Modular system for connecting cables			–	NEBU... → Internet: nebu
Cover					
	Hood for CPX-AB-8-KL-4POL (IP65/67)		8 cable through-feeds M9 1 cable through-feed for multi-pin plug	538219	AK-8KL
	Fittings kit for hood AK-8KL			538220	VG-K-M9
	Cover cap for sealing unused M12 connections (10 pieces)			165592	ISK-M12
Screening plate					
	Screening plate for connection block • CPX-AB-4-M12X2-5POL • CPX-AB-4-M12X2-5POL-R			526184	CPX-AB-S-4-M12
User documentation					
	User documentation		German	526415	P.BE-CPX-AX-DE
			English	526416	P.BE-CPX-AX-EN
			Spanish	526417	P.BE-CPX-AX-ES
			French	526418	P.BE-CPX-AX-FR
			Italian	526419	P.BE-CPX-AX-IT
			Swedish	526420	P.BE-CPX-AX-SV

Terminal CPX-P

Technical data – Interlinking block with system supply



Function

Interlinking blocks ensure the electrical supply of all other CPX-P modules. They have contact rails, from which the other CPX-P components on the interlinking modules are supplied with current.

Internal division of the power supply makes it possible to switch off specific areas of the sensors and actuators individually.

Applications

- 24 V DC supply voltage for electronics of the CPX-P terminal
- 24 V DC supply voltage for inputs
- 24 V DC supply voltage for valves
- 24 V DC supply voltage for outputs





General technical data			
Nominal operating voltage	[V DC]	24	
Protection class to EN 60529		Depending on connection block	
Ambient temperature	[°C]	-5 ... +50	
Note on materials		RoHS-compliant	
Grid dimension	[mm]	50	
Dimensions W x L x H	[mm]	50 x 107 x 35	
Electrical connection		7/8", 5-pin	
Current supply	Sensors and electronics	[A]	Max. 8
	Valves and outputs	[A]	Max. 8
Materials		Die-cast aluminium	
Product weight	[g]	187	

Pin allocation		
Circuitry	Pin	Allocation
Round plug, 5-pin		
	7/8"	
		1
	2	0 V electronics and sensors
	3	FE
	4	24 V DC supply voltage for electronics and sensors
	5	24 V DC load voltage supply for valves and outputs

Terminal CPX-P

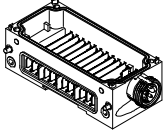
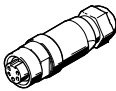
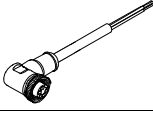
Technical data – Interlinking block with system supply

Ordering data					
Designation				Part No.	Type
Interlinking block with system supply					
	7/8" connection, metal interlinking block	5-pin	–	550208	CPX-M-GE-EV-S-7/8-5POL
			For ATEX environment	8022165	CPX-M-GE-EV-S-7/8-5POL-VL
7/8" connection sockets					
	Power supply socket	5-pin		543107	NECU-G78G5-C2
	Angled socket, 5-pin – open cable end, 5-pin	2 m		573855	NEBU-G78W5-K-2-N-LE5
Mounting accessories					
	Screws for mounting the bus node/connection block on an interlinking block	Bus node/plastic connection block		550219	CPX-M-M3x22-4x
		Bus node/metal connection block		550216	CPX-M-M3x22-S-4x

Terminal CPX-P

Technical data – Interlinking block

Function

Interlinking blocks ensure the electrical supply of all other CPX-P modules. They have contact rails, from which the other CPX-P components on the interlinking modules are supplied with current.

Internal division of the power supply makes it possible to switch off specific areas of the sensors and actuators individually.

Applications

- All voltages are fed through to the next module by means of interlinking blocks.
- The connected electronics module for inputs/outputs or bus node taps off the required voltage.





General technical data		
Electrical connection		–
Nominal operating voltage	[V DC]	24
Acceptable current load (per contact/contact rail)	[A]	16
Protection class to EN 60529		Depending on connection block
Ambient temperature	[°C]	–5 ... +50
Note on materials		RoHS-compliant
Materials		Aluminium
Grid dimension	[mm]	50
Dimensions W x L x H	[mm]	50 x 107 x 35
Product weight	[g]	162

Pin allocation			
Circuitry		Pin	Allocation
	0V Valves	–	–
	24V Valves	–	–
	0V Output	–	–
	24V Output	–	–
	0V El./Sen.		
	24V El./Sen.		
	FE		

Terminal CPX-P

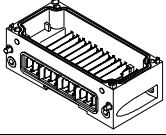
Technical data – Interlinking block

Ordering data			
Designation		Part No.	Type
Interlinking block without supply			
	Metal interlinking block	550206	CPX-M-GE-EV
Mounting accessories			
	Screws for mounting the bus node/connection block on an interlinking block	Bus node/plastic connection block	550219 CPX-M-M3x22-4x
		Bus node/metal connection block	550216 CPX-M-M3x22-S-4x

Terminal CPX-P

Technical data – Interlinking block with additional power supply for outputs



Function

Interlinking blocks ensure the electrical supply of all other CPX-P modules. They have contact rails, from which the other CPX-P components on the interlinking modules are supplied with current.

Internal division of the power supply makes it possible to switch off specific areas of the sensors and actuators individually.

Applications

- 24 V DC supply voltage for outputs





General technical data		
Nominal operating voltage	[V DC]	24
Protection class to EN 60529		Depending on connection block
Ambient temperature	[°C]	-5 ... +50
Note on materials		RoHS-compliant
Grid dimension	[mm]	50
Dimensions W x L x H	[mm]	50 x 107 x 35
Electrical connection		7/8", 5-pin
Current supply	Outputs	[A] Max. 8
Materials		Die-cast aluminium
Product weight	[g]	187

Pin allocation – Metal interlinking blocks			
Circuitry		Pin	Allocation
Round plug, 5-pin			
		1	0 V outputs
		2	n.c.
		3	FE
		4	n.c.
		5	24 V DC load voltage supply for outputs

Terminal CPX-P

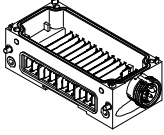
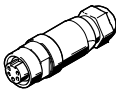
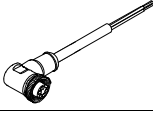
Technical data – Interlinking block with additional power supply for outputs

Ordering data					
Designation				Part No.	Type
Interlinking block with additional power supply for outputs					
	7/8" connection, metal interlinking block	5-pin	–	550210	CPX-M-GE-EV-Z-7/8-5POL
		5-pin	For ATEX environment	8022158	CPX-M-GE-EV-Z-7/8-5POL-VL
7/8" connection sockets					
	Power supply socket	5-pin		543107	NECU-G78G5-C2
	Angled socket, 5-pin – open cable end, 5-pin	2 m		573855	NEBU-G78W5-K-2-N-LE5
Mounting accessories					
	Screws for mounting the bus node/connection block on an interlinking block	Bus node/plastic connection block		550219	CPX-M-M3x22-4x
		Bus node/metal connection block		550216	CPX-M-M3x22-S-4x

Terminal CPX-P

Technical data – Pneumatic interface VMPA-FB

Function

The pneumatic interface VMPA-FB establishes the electromechanical connection between the CPX-P terminal and the valve terminal MPA-S. The signals from the bus node are forwarded to the control electronics in the electrical modules of the valve terminal MPA-S via the integrated CPX-P bus. The bus signal for activation of the solenoid coils is converted in the electronics module for max. 8 coils. From a technical point of view, the individual MPA pneumatic modules each represent a separate electric module with digital outputs. Valves, which are galvanically isolated, can be supplied with power via the interlinking block CPX-GE-EV-V.

Applications

- Interface to the valve terminal MPA-S
- Max. 128 solenoid coils
- Features of the electronics module of the valve terminal MPA-S can be parameterised, for example status of the solenoid coils in the event of fieldbus communication being interrupted (fail-safe), individual channel diagnostics can be activated, condition monitoring can be activated individually for each valve
- The pneumatic interface receives the voltage for the electronics and the supply voltage for the valves from the left-hand interlinking block and feeds them through to the electronics modules of the valve terminal MPA-S
- Electronics modules of the valve terminal MPA-S:
 - Undervoltage of valves
 - Short circuit of valves
 - Open load of valves
 - Counter preset reached in condition monitoring



General technical data		
Type	VMPA-FB-EPL-G	VMPA-FB-EPL-E
Number of solenoid coils	128	
Pilot air supply	Internal	External
Pilot air port 12/14	–	M7
Pneumatic connection 1	G $\frac{1}{4}$	G $\frac{1}{4}$
Operating pressure [bar]	3 ... 8	–0.9 ... 10
Pilot pressure [bar]	3 ... 8	3 ... 8
Nominal operating voltage [V DC]	24	
Protection class to EN 60529	IP65	
Ambient temperature [°C]	–5 ... +50	
Materials	Cover	PA
	Housing	Die-cast aluminium
Product weight [g]	Approx. 320	

Terminal CPX-P

Technical data – Pneumatic interface VMPA-FB

Overview – Pneumatic interface VMPA-FB

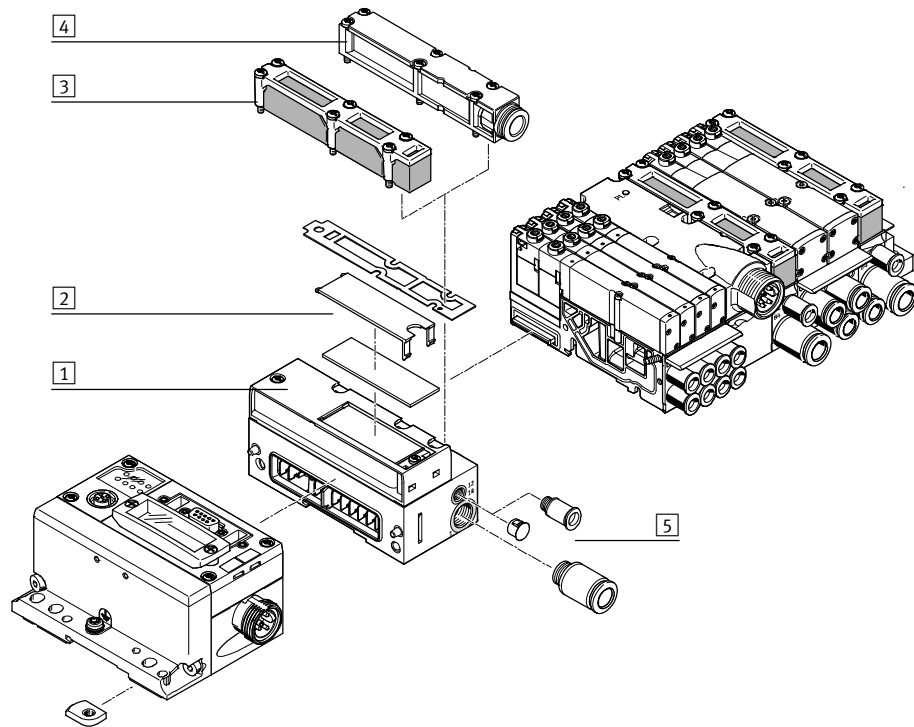

- 1 Pneumatic interface VMPA-FB
- 2 Inscription label
- 3 Flat plate silencer
- 4 Exhaust plate for ducted exhaust air
- 5 Fittings

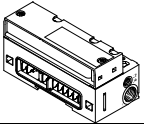
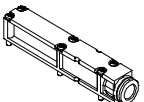
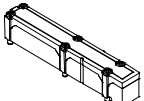
Ordering data		
Designation	Part No.	Type
Pneumatic interface		
	Ducted exhaust air, internal pilot air	552286 VMPA-FB-EPLM-G
	Ducted exhaust air, external pilot air	552285 VMPA-FB-EPLM-E
	Flat plate silencer, internal pilot air	552288 VMPA-FB-EPLM-GU
	Flat plate silencer, external pilot air	552287 VMPA-FB-EPLM-EU
Exhaust plate		
	For ducted exhaust air, with 10 mm push-in connector	533375 VMPA-AP
	For ducted exhaust air, with QS-3/8 connector	541629 VMPA-AP-3/8
	Flat plate silencer	533374 VMPA-APU

Terminal CPX-P

Technical data

FESTO

Dimensions – Metal interlinking block

Download CAD data → www.festo.com

With bus nodes and connection blocks

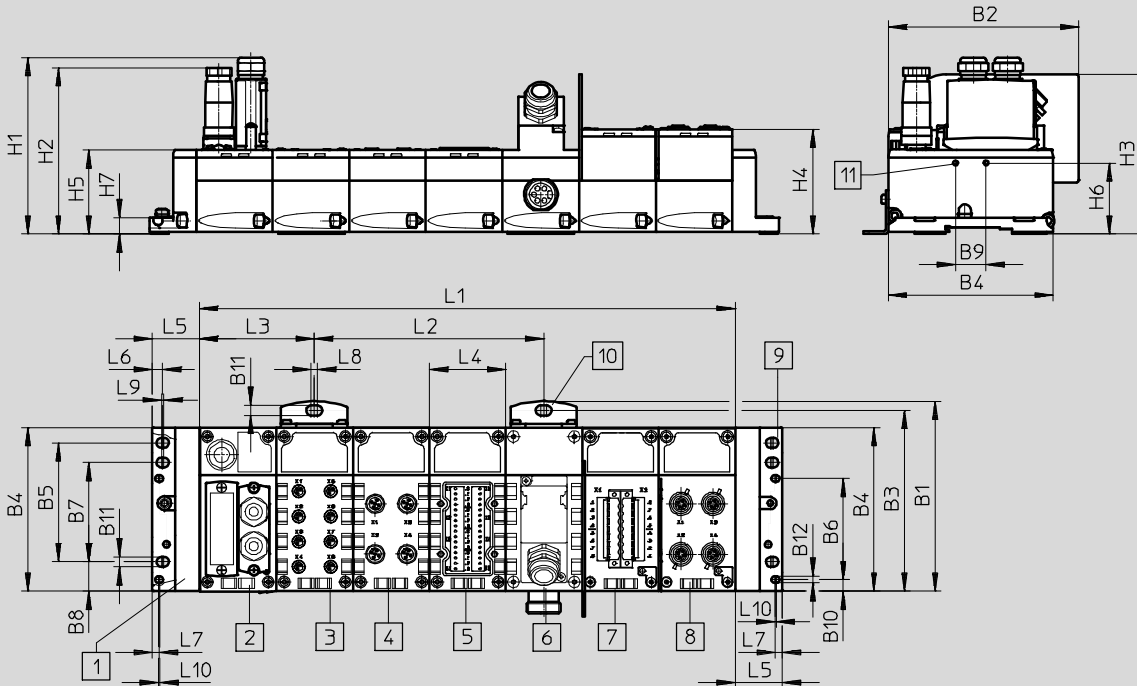

- | | | | |
|---|---|---|--|
| 1 Left-hand end plate | 5 Connection block
CPX-AB-8-KL-4POL | 8 Connection block
CPX-AB-4-HAR-4POL | 10 Mounting bracket for wall
mounting |
| 2 Bus node | 6 Connection block
CPX-AB-1-SUB-BU-25POL | 9 Right-hand end plate | 11 Hole for self-tapping screw
M2.5 |
| 3 Connection block
CPX-AB-8-M8-3POL | 7 Connection block CPX-
P-AB-4-2XKL-8POL | | |
| 4 Connection block
CPX-AB-4-M12X2-5POL | | | |

Type	B1	B2	B3	B4	B5	B6	B7	B8	B9	B10	B11	B12
CPX-P	124.9	124.6	118.9	108.1	78	66.3	65	19.3	20	7.9	6.6	4.4

Type	H1	H2	H3	H4	H5	H6	H7
CPX-P	116	109	106.2	69.2	55.1	46.6	10.8

Type	L1	L2	L3	L4	L5	L6	L7	L8	L9	L10
CPX-P	nx50.1	150.3	125.3	50.1	30.4	6.8	4.5	4	1.5	1

Terminal CPX-P

Technical data

Dimensions

Download CAD data → www.festo.com

With bus nodes and valve terminal MPA-S

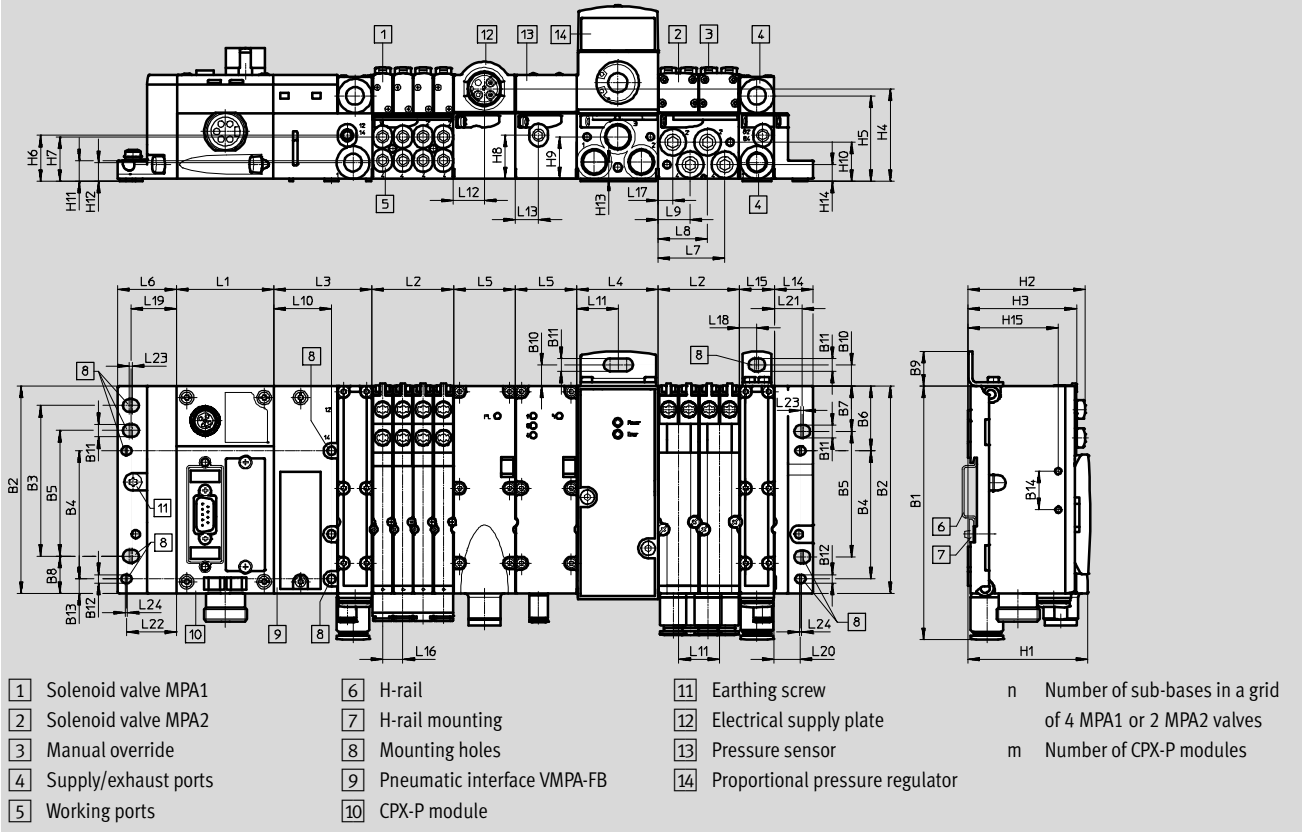

Type	B1	B2	B3	B4	B5	B6	B7	B8	B9	B10	B11	B12	B13	B14
CPX-P	131.4	107.3	78	66.3	65	33.5	23.5	19.3	18	11	6.6	4.4	7.5	20

Type	H1	H2	H3	H4	H5	H6	H7	H8	H9	H10	H11	H12	H13	H14	H15
CPX-P	62	60.5	56	48	44.3	23.9	23.1	22.6	21.8	20.3	10.8	9.8	8.8	8.7	46.6





Type	L1	L2	L3	L4	L5	L6	L7	L8	L9	L10	L11	L12
CPX-P	m x 50.1	n x 42	51.2	42	32	30.4	34.7	25.7	16.7	30	21	16

Type	L13	L14	L15	L16	L17	L18	L19	L20	L21	L22	L23	L24
CPX-P	12	20	18	10.5	7.7	9	23.7	13.5	14.5	25.9	1.5	1

Terminal CPX-P

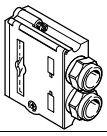
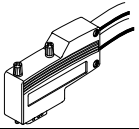
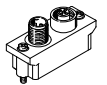
Accessories

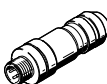
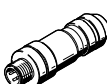
FESTO

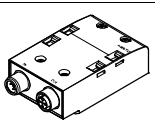
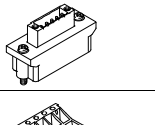
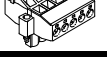
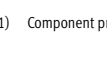

Ordering data – Accessories						
Designation				Part No.	Type	
Plug connectors						
	Sub-D socket, 9-pin		For DeviceNet	532219	FBS-SUB-9-BU-2x5POL-B	
	Sub-D plug, 9-pin		For PROFIBUS DP	532216	FBS-SUB-9-GS-DP-B	
			For CPX-FEC	534497	FBS-SUB-9-GS-1x9POL-B	
	Sub-D plug, angled		For PROFIBUS DP	533780	FBS-SUB-9-WS-PB-K	
	Bus connection, adapter to 5-pin M12 plug/socket	Sub-D plug, 9-pin	B-coded	For PROFIBUS-DP	533118	FBA-2-M12-5POL-RK
		Sub-D socket, 9-pin	Micro Style	For DeviceNet	525632	FBA-2-M12-5POL
	M12 socket, 5-pin	Screw terminal	For FBA-2-M12-5POL		18324	FBSD-GD-9-5POL
		Screw terminal	For FBA-2-M12-5POL-RK and CPX-AB-2-M12-RK-DP		1067905	NECU-M-B12G5-C2-PB
	Plug M8, 3 pin	Solderable	For NEDU-M8D3-M8T4		18696	SEA-GS-M8
		Screw-in	For NEDU-M8D3-M8T4		192009	SEA-3GS-M8-S
	Plug M12, 4 pin	Spring-loaded terminal	For cable Ø 4 ... 8 mm		575719	NECU-M-S-A12G4-IS¹⁾
			Screw terminal	D-coded	For Ethernet	543109
		For cable Ø 2.5 ... 2.9 mm		570955	NECU-S-M12G4-P1-Q6-IS¹⁾	
				192008	SEA-4GS-7-2,5	
		For cable Ø 2x3 mm or 2x5 mm		570956	NECU-S-M12G4-D-IS¹⁾	
		For 2x cable Ø 3 ... 5 mm		18779	SEA-GS-11-DUO	
		For cable Ø 4 ... 6 mm		570953	NECU-S-M12G4-P1-IS¹⁾	
				18666	SEA-GS-7	
		For cable Ø 6 ... 8 mm		570954	NECU-S-M12G4-P2-IS¹⁾	
				18778	SEA-GS-9	
Plug, M12, 5-pin	Screw terminal	For 2x cable Ø 2.5 ... 5 mm		192010	SEA-5GS-11-DUO	
		For cable Ø 4 ... 6 mm		175487	SEA-M12-5GS-PG7	
		For FBA-2-M12-5POL		175380	FBS-M12-5GS-PG9	
		For FBA-2-M12-5POL-RK and CPX-AB-2-M12-RK-DP		1066354	NECU-M-S-B12G5-C2-PB	
	HARAX plug, 4-pin	Insulation displacement connector			525928	SEA-GS-HAR-4POL
	Connection block, adapter to 5-pin 7/8" plug	Sub-D socket, 9-pin	–	For DeviceNet	571052	CPX-AB-1-7/8-DN
	Connection block, adapter to M12 plug/socket	Sub-D plug, 9-pin	B-coded	For PROFIBUS-DP	541519	CPX-AB-2-M12-RK-DP
	Open Style bus connection for 5-pin terminal strip		For DeviceNet	525634	FBA-1-SL-5POL	
	5-pin terminal strip		For Open Style connection	525635	FBSD-KL-2x5POL	

1) Component preferred for operation in intrinsically safe circuits.

Terminal CPX-P

Accessories

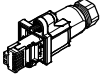
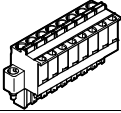
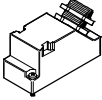
FESTO

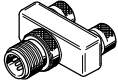
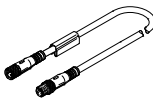
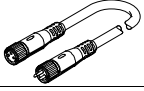
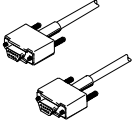





Ordering data – Accessories						
Designation				Part No.	Type	
Plug connectors						
	RJ45 plug			534494	FBS-RJ45-8-GS	
	Socket, 8-pin	Spring-loaded terminal	Black	565712	NECU-L3G8-C1	
			Gentian blue	565711	NECU-L3G8-C1-IS ¹⁾	
		Screw terminal	Black	565710	NECU-L3G8-C2	
			Gentian blue	565709	NECU-L3G8-C2-IS ¹⁾	
	Sub-D plug, 25-pin			527522	SD-SUB-D-ST25	
Connecting cables						
	DUO cable	1x plug, M12, 4-pin	2x straight socket, M8, 3-pin	18685	KM12-DUO-M8-GDGD	
			2x straight/angled socket, M8, 3-pin	18688	KM12-DUO-M8-GDWD	
			2x angled socket, M8, 3-pin	18687	KM12-DUO-M8-WDWD	
	Push-in T-connector	1x plug, M8, 4-pin	2x socket, M8, 3-pin 1x plug, M8, 4-pin	544391	NEDU-M8D3-M8T4	
			1x plug, M12, 4-pin	2x socket, M8, 3-pin	541597	NEDU-M8D3-M12T4
		2x socket, M12, 4-pin		562248	NEDU-M12D4-M12T4-IS ¹⁾	
		2x socket, M12, 5-pin	541596	NEDU-M12D5-M12T4		
	Connecting cable M8-M8	3-pin	Straight plug/ straight socket	0.5 m	175488	KM8-M8-GSGD-0,5
				1.0 m	175489	KM8-M8-GSGD-1
				2.5 m	165610	KM8-M8-GSGD-2,5
				5.0 m	165611	KM8-M8-GSGD-5
	Connecting cable M12-M12	4-pin	Straight plug/ straight socket	2.5 m	18684	KM12-M12-GSGD-2,5
				5.0 m	18686	KM12-M12-GSGD-5
		5-pin	Straight plug/ angled socket	1.0 m	185499	KM12-M12-GSWD-1-4
				Straight plug/ straight socket	1.5 m	529044
3.5 m	530901	KV-M12-M12-3,5				
	Modular system for connecting cables			–	NEBU-... → Internet: nebu	
	Programming cable for connecting the CPX-FEC			3 m	151915	KDI-PPA-3-BU9
	Connecting cable from the control block CPX-FEC to a display and operating unit (FED)	Pre-assembled at one end		5.0 m	539642	FEC-KBG7
		Pre-assembled at both ends		2.5 m	539643	FEC-KBG8

1) Component preferred for operation in intrinsically safe circuits.

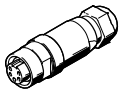
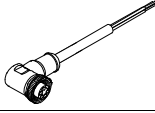
Terminal CPX-P

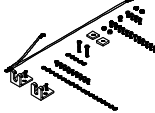
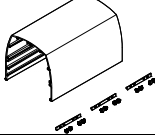
Accessories

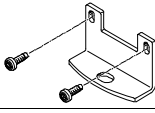
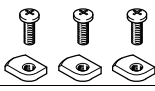
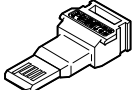
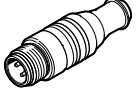
FESTO

Ordering data – Accessories				
Designation			Part No.	Type
Plug connectors and accessories – Power supply				
	Power supply socket, straight	7/8" connection, 5-pin	543107	NECU-G78G5-C2
	7/8" power supply socket, 5-pin, angled socket/open cable end, 5-pin	2 m	573855	NEBU-G78W5-K-2-N-LE5
Hood				
	Mounting rail for attaching the hood	1,000 mm	572256	CAFC-X1-S
	Mounting kit for CPX hood		572257	CAFC-X1-BE
	Hood section for CPX-P terminal including mounting attachments for connecting several hood sections in series	200 mm	572258	CAFC-X1-GAL-200
		300 mm	572259	CAFC-X1-GAL-300
Screws				
	Screws for mounting the bus node/connection block on an interlinking block	Bus node/plastic connection block	550219	CPX-M-M3x22-4x
		Bus node/metal connection block	550216	CPX-M-M3x22-S-4x
	Screws for attaching an inscription label holder to the bus node (CPX-FB33)	12 piece	550222	CPX-M-M2,5x8-12X
Mounting				
	Attachment for wall mounting (for long valve terminals, 2 mounting brackets and 4 screws)	Version for metal interlinking plates	550217	CPX-M-BG-RW-2x
	Mounting for H-rail		526032	CPX-CPA-BG-NRH
Function blocks				
	Memory card for PROFINET bus node (CPX-FB33, CPX-M-FB34, CPX-M-FB35), 2MB		568647	CPX-SK-2
	Terminating resistor, M12, B-coded for PROFIBUS		1072128	CACR-S-B12G5-220-PB
	Adapter from 5-pin M12 to mini USB socket and controller software		547432	NEFC-M12G5-0.3-U1G5

Terminal CPX-P

Accessories

FESTO

Ordering data – Accessories				
Designation			Part No.	Type
Covers and attachments				
	Hood for CPX-AB-8-KL-4POL (IP65/67)	8 cable through-feeds M9 1 cable through-feed for multi-pin plug	538219	AK-8KL
	Fittings kit for hood AK-8KL		538220	VG-K-M9
	Screening plate for connection block	<ul style="list-style-type: none"> CPX-AB-4-M12X2-5POL CPX-AB-4-M12X2-5POL-R 	526184	CPX-AB-S-4-M12
	Inspection cover, transparent		533334	AK-SUB-9/15-B
	Transparent cover for DIL switch and memory card		548757	CPX-AK-P
	Cover for RJ45 connection		534496	AK-Rj45
	Cover cap for sealing unused connections (10 pieces)	For M8 connections	177672	ISK-M8
		For M12 connections	165592	ISK-M12
	Coding element (96 pieces of each)	For NECU-L3G8	565713	CPX-P-KDS-AB-2XKL
	Insulating plate for safe separation of intrinsically safe and non-intrinsically safe areas of the CPX terminal		565708	CPX-P-AB-IP
Inscription labels				
	Inscription labels 6x10 mm, 64 pieces, in frames		18576	IBS-6x10
	Inscription label holder for connection block		536593	CPX-ST-1
Software				
	Programming software	German	537927	P.SW-FST4-CD-DE
		English	537928	P.SW-FST4-CD-EN

1) Component preferred for operation in intrinsically safe circuits.