

# End-position controllers CPX-CMPX



# End-position controllers CPX-CMPX

Overview

FESTO

## Servo-pneumatic drive technology

Positioning and Soft Stop applications as an integral component of the valve terminal CPX – the modular peripheral system for decentralised automation tasks.

The modular design means that valves, digital inputs and outputs, positioning modules and end-position controllers, as appropriate to the application, can be combined in almost any way on the CPX terminal.

### Advantages:

- Pneumatics and electrics – control and positioning on one platform
- Innovative positioning technology – piston rod drives, rodless drives, rotary drives
- Actuation via fieldbus
- Remote maintenance, remote diagnostics, web server, SMS and e-mail alert are all possible via TCP/IP
- Modules can be quickly exchanged and expanded without altering the wiring

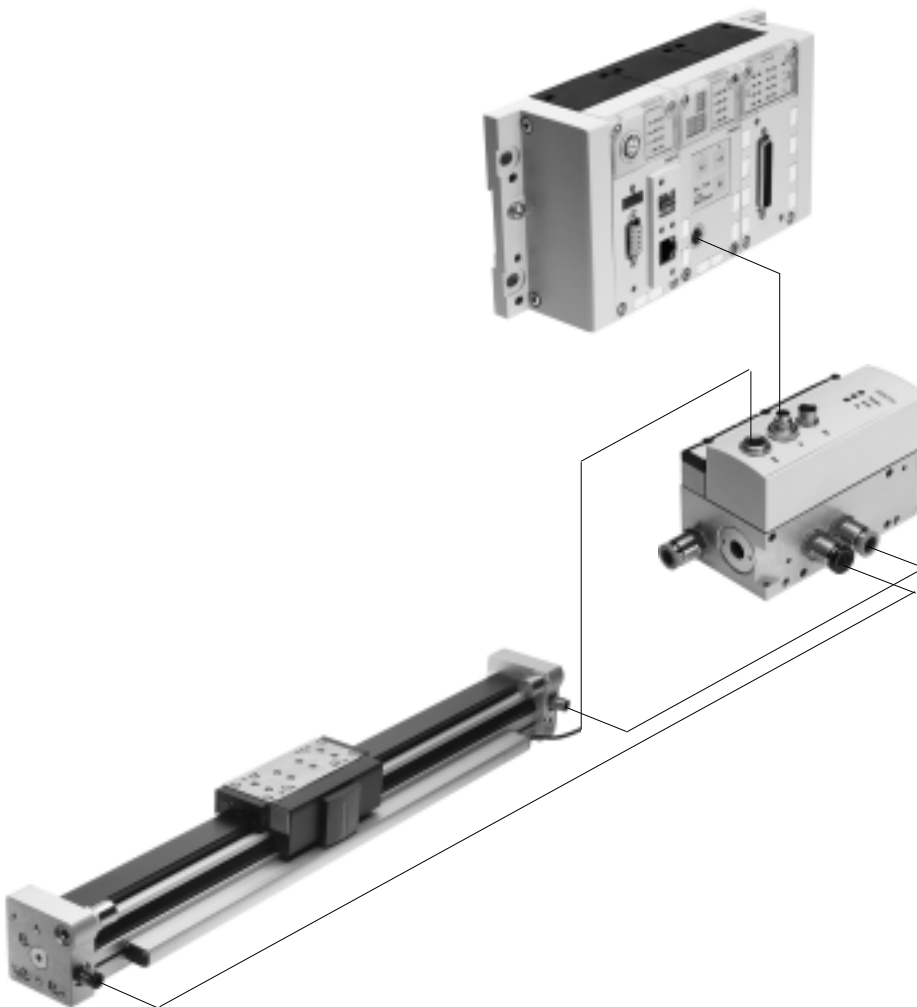

# End-position controllers CPX-CMPX

Key features

FESTO

## Axis controllers CPX-CMAX



**Free choice:**  
Position and force control, directly actuated or selected from one of 64 configurable position sets. If you are looking for something more:  
the configurable function for switching to the next set enables simple functional sequences to be realised in the axis controller CPX-CMAX. Everything is recognisable: the auto-identification function identifies each station with its device data on the controller CPX-CMAX.

**Also included:**  
The functional scope of the controller CPX-CMAX includes actuation of a brake or clamping unit via the proportional directional control valve VPWP. Up to 7 modules (max. 7 axes) can be operated in parallel and independently of each other. Commissioning via FCT (Festo configuration software) or via fieldbus: no programming, only configuration.

Technical data → Internet: [cpx-cmax](#)

- Advantages:**
- Greater flexibility
  - OEM friendly – commissioning also via fieldbus
  - Clear installation and fast commissioning
  - Cost-effective
  - You program the system in your PLC environment

## End-position controllers CPX-CMPX



Fast travel between the mechanical end stops of the cylinder, stopping gently and without impact in the end position. Fast commissioning via control panel, fieldbus or handheld unit. Improved control of downtime. Actuation of a brake or clamping unit via the proportional directional control valve VPWP is an integral component of the controller CMPX.

Depending on the fieldbus chosen, up to 9 end-position controllers can be actuated on the CPX terminal. All system data can be read and written via the fieldbus, including, for example the mid positions.

Technical data → 7

- Advantages:**
- Greater flexibility
  - OEM friendly – commissioning also via fieldbus
  - Clear installation and fast commissioning
  - Cost-effective
    - Up to 30% faster cycle rates
    - Significantly reduced system vibration
  - Improved work ergonomics thanks to significantly reduced noise level
  - The extended diagnostics help to reduce the service time of the machine

## Proportional directional control valve VPWP



The 5/3-way proportional directional control valve for applications with Soft Stop and pneumatic positioning. Fully digitalised – with integrated pressure sensors, with new diagnostic functions. In sizes 4, 6 and 8. Flow rate of 350, 700 and 1,400 l/min.

With switching output for actuating a brake. Coloured supply ports. Pre-assembled cables guarantee faultless and fast connection with the controllers CPX-CMPX and CPX-CMAX.

Technical data → Internet: [vpwp](#)

- Advantages:**
- Clear installation and fast commissioning
  - Reduction of system downtimes thanks to the new diagnostic options
  - With switching output for actuating a brake/clamping unit

# End-position controllers CPX-CMPX

Drive options

FESTO

## System with linear drive DDLI, DGCI

Technical data → Internet: [ddli](#) or [dgci](#)

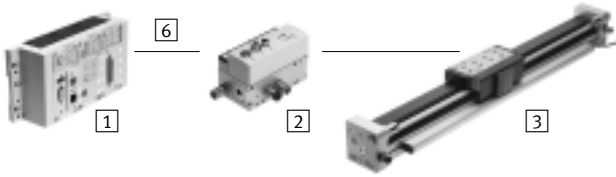

- 1 Controller module CPX-CMPX or CPX-CMAX
- 2 Proportional directional control valve VPWP
- 3 Linear drive DDLI, DGCI with displacement encoder
- 6 Connecting cable KVI-CP-3-...

- Pneumatic rodless linear drive with displacement encoder, with or without recirculating ball bearing guide
- Displacement encoder with absolute and contactless measurement
- Diameters:
  - DGCI: 18 ... 63 mm
  - DDLI: 25 ... 63 mm
- Stroke: 100 ... 2000 mm in fixed lengths
- Range of applications: Soft Stop and pneumatic positioning
- Loads from 1 ... 180 kg
- No sensor interface required

Advantages:

- Complete drive unit
- DDLI for easy connection to customer's guide system
- Excellent running characteristics
- For fast and accurate positioning down to  $\pm 0.2$  mm (only with axis controller CPX-CMAX)

## System with standard cylinder DNCI, DDPC

Technical data → Internet: [dncl](#)

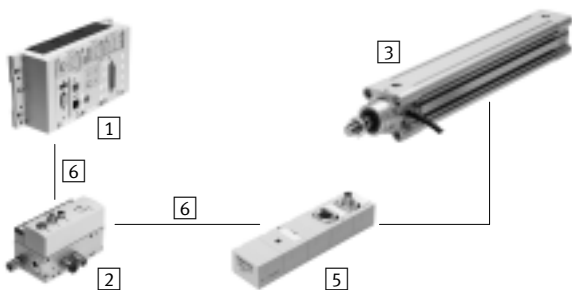

- 1 Controller module CPX-CMPX or CPX-CMAX
- 2 Proportional directional control valve VPWP
- 3 Standard cylinder DNCI, DDPC with displacement encoder
- 5 Sensor interface CASM-S-D3-R7
- 6 Connecting cable KVI-CP-3-...

- Standard cylinder with integrated displacement encoder, conforms to DIN ISO 6432, VDMA 24 562, NF E 49 003.1 and Uni 10 290
- Displacement encoder with contactless and incremental measuring
- Diameter: 32 ... 100 mm
- Stroke: 100 ... 750 mm
- Range of applications: Soft Stop and pneumatic positioning
- Loads from 3 ... 450 kg and a matching sensor interface CASM-S-D3-R7
- Pre-assembled cables guarantee faultless and fast electrical connection

Advantages:

- Compact drive unit
- Can be used universally
- Also with guide unit
- For fast and accurate positioning up to  $\pm 0.5$  mm (only with axis controller CPX-CMAX)

# End-position controllers CPX-CMPX

Drive options

FESTO

## System with swivel module DSMI

Technical data → Internet: dsmi

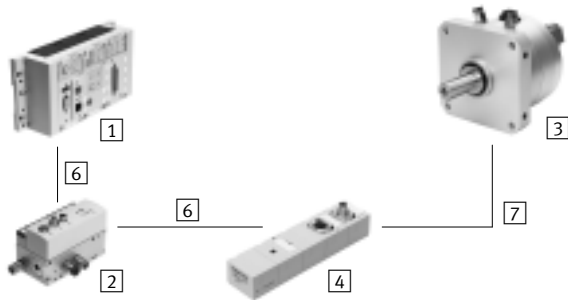

- 1 Controller module CPX-CMPX or CPX-CMAX
- 2 Proportional directional control valve VPWP
- 3 Swivel module DSMI with displacement encoder
- 4 Sensor interface CASM-S-D2-R3
- 6 Connecting cable KVI-CP-3-...
- 7 Connecting cable NEBC-P1W4-K-0,3-N-M12G5

- Swivel module DSMI with integrated displacement encoder
- Identical construction as pneumatic swivel module DSM
- Absolute displacement encoder on basis of potentiometer
- Swivel range from 0 ... 270°
- Size: 25, 40, 63
- Max. torque: 5 ... 40 Nm
- Range of application of Soft Stop and pneumatic positioning: mass moments of inertia from 15 ... 6,000 kgcm<sup>2</sup> and the matching sensor interface CASM-S-D2-R3
- Pre-assembled cables guarantee faultless and fast connection with the proportional directional control valve VPWP

Advantages:

- Complete drive unit, compact, can be used immediately
- High angular acceleration
- With adjustable fixed stops
- For fast and accurate positioning down to ±0.2° (only with axis controller CPX-CMAX)

## System with potentiometer

Technical data → Internet: casm

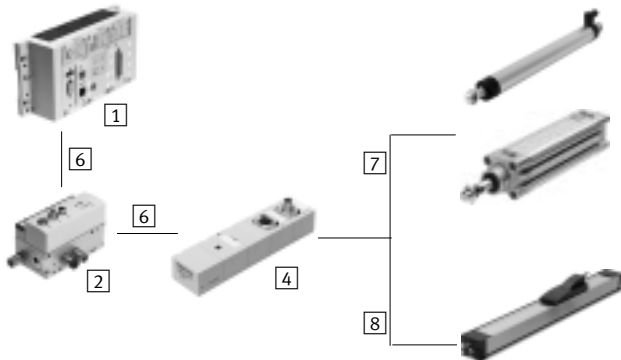

- 1 Controller module CPX-CMPX or CPX-CMAX
- 2 Proportional directional control valve VPWP
- 4 Sensor interface CASM-S-D2-R3
- 6 Connecting cable KVI-CP-3-...
- 7 Connecting cable NEBC-P1W4-K-0,3-N-M12G5
- 8 Connecting cable NEBC-A1W3-K-0,4-N-M12G5

- Attachable potentiometers with absolute measurement, with high degree of protection
- With connecting rod or moment compensator
- Measuring range:  
Connecting rod: 100 ... 750 mm  
Moment compensator: 225 ... 2000 mm
- Pre-assembled cables guarantee faultless and fast connection with the sensor interface CASM
- Range of applications: Soft Stop and pneumatic positioning with cylinder Ø 25 ... 80 mm, e.g. DNC or DSBC
- Loads from 1 ... 300 kg

Advantages:

- Easy installation and fast commissioning
- Cost-effective
- Can also be used in harsh ambient conditions
- Variety of drives: CPX-CMPX and CPX-CMAX also support cylinders with external displacement encoder

# End-position controllers CPX-CMPX

Drive options



System components for Soft Stop systems with end-position controller CPX-CMPX							
[3]		Linear drive	Standard cylinder	Swivel module	Displacement encoder		→ Page/ Internet
		DDLI/DGCI	DNCI/DDPC	DSMI	MLO-LWG/-TLF	MME-MTS	
[1]	End-position controller CPX-CMPX	■	■	■	■	■	7
[2]	Proportional directional control valve VPWP	■	■	■	■	■	vpwp
[4]	Sensor interface CASM-S-D2-R3	-	-	■	■	-	casm
[5]	Sensor interface CASM-S-D3-R7	-	■	-	-	-	casm
[6]	Connecting cable KVI-CP-3-...	■	■	■	■	■	10
[7]	Connecting cable NEBC-P1W4-...	-	-	■	■ / -	-	nebc
[8]	Connecting cable NEBC-A1W3-...	-	-	-	- / ■	-	nebc
[9]	Connecting cable NEBP-M16W6-...	-	-	-	-	■	nebp

# End-position controllers CPX-CMPX

Type codes and peripherals overview

## Type codes

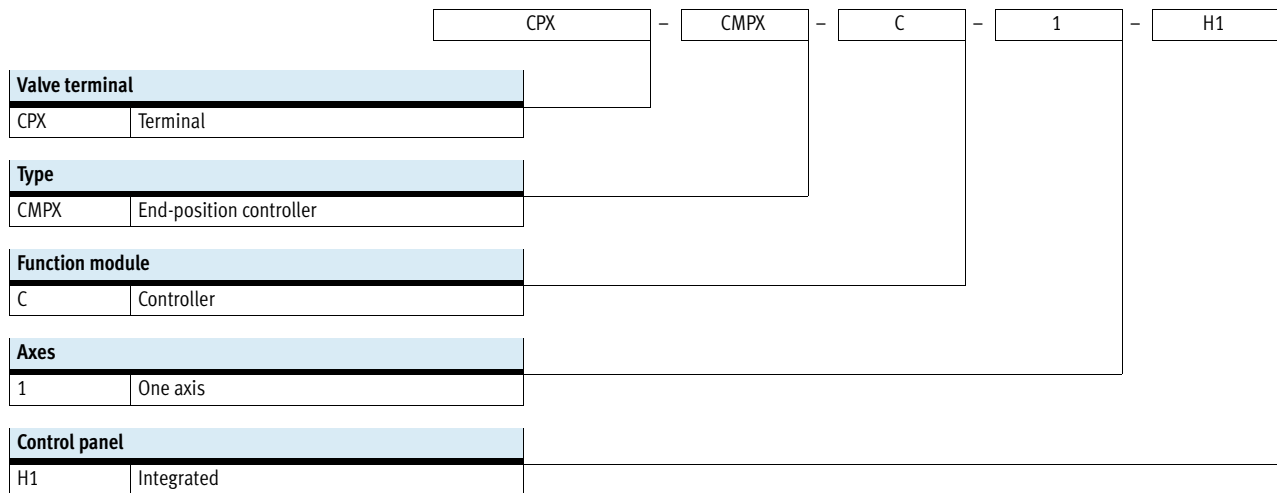

## Peripherals overview

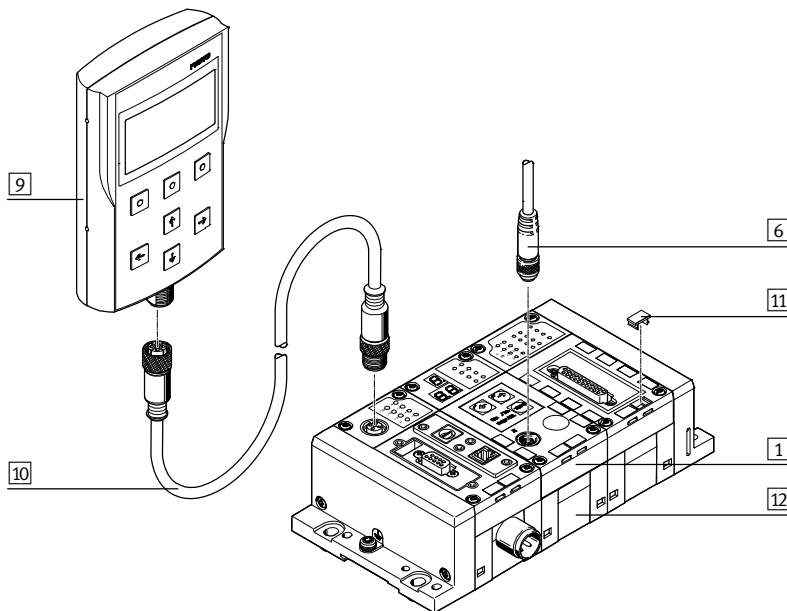

## Accessories

	Type	Brief description	→ Page/Internet
1	End-position controller CPX-CMPX	Integrated in the CPX terminal. Screws for mounting on the plastic interlinking block are included in the scope of delivery.	8
6	Connecting cable KVI-CP-3	For connecting end-position controller CPX-CMPX and proportional directional control valve VPWP.	10
9	Operator unit CPX-MMI-1	Commissioning and servicing unit for the CPX terminal. It provides data requisition, configuration and diagnostics functions for CPX terminals.	11
10	Connecting cable KV-M12	For connecting the operator unit CPX-MMI-1 and CPX terminal.	10
11	Inscription label IBS	For labelling the modules.	10
12	Interlinking block CPX-GE	Connects the individual modules. Two versions are available: plastic or metal interlinking block.	11
-	Screws CPX-M-M3	For mounting on the metal interlinking block.	10

# End-position controllers CPX-CMPX

## Technical data

The end-position controller CPX-CMPX is intended exclusively for use in valve terminals CPX.



General technical data			
Operating voltage			
Operating voltage range	[V DC]	18 ... 30	
Nominal operating voltage	[V DC]	24	
Current consumption at nominal operating voltage	[mA]	80	
Load voltage			
Load voltage range	[V DC]	20 ... 30	
Nominal load voltage	[V DC]	24	
Perm. load current	[A]	2.5	
Number of axes per module			
		1	
Length of connecting cable to axis	[m]	≤ 30	
Max. no. of modules			
		9	
Display			
		7-segment display	
Control elements			
		3 keys	
Assigned addresses	Outputs	[bit]	6x8
	Inputs	[bit]	6x8
Diagnostics			
		Module-orientated	
		Via local 7-segment display	
		Via operator unit CPX-MMI-1	
Status display			
		Module status	
		Power Load	
Control interface			
Data		CAN bus with Festo protocol	
		Digital	
Electrical connection		5-pin	
		M9	
		Socket	
Materials: Housing			
		Reinforced PA	
Product weight	[g]	240	
Dimensions	Length	[mm]	107
	Width	[mm]	50
	Height	[mm]	55



# End-position controllers CPX-CMPX

Technical data

Operating and environmental conditions		
Ambient temperature	[°C]	-5 ... +50
Relative air humidity	[%]	5 ... 95, non-condensing
Protection class to IEC 60529		IP65
CE mark (see declaration of conformity)		To EU EMC Directive

## Connection and display components

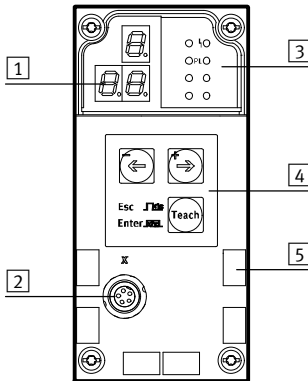

- 1 3-digit display
- 2 Control interface
- 3 Status LEDs
- 4 Operating buttons
- 5 Inscription labels

Pin allocation – plug 2			
	Pin	Signal	Designation
	1	+24 V	Nominal operating voltage
	2	+24 V	Load voltage
	3	0 V	Ground
	4	CAN_H	CAN high
	5	CAN_L	CAN low
	Housing	Screened	Cable screening

Permitted bus nodes/FEC		
Bus node/FEC	Protocol	Max. no. of CMPX modules
CPX-FEC	-	9
CPX-CEC...	-	9
CPX-FB6	INTERBUS	2
CPX-FB11	DeviceNet <sup>1)</sup>	9
CPX-FB13	PROFIBUS <sup>2)</sup>	9
CPX-FB14	CANopen	5
CPX-M-FB20	INTERBUS	2
CPX-M-FB21	INTERBUS	2
CPX-FB23-24	CC-Link	5 (function module F23)
		9 (function module F24)
CPX-FB32	EtherNet/IP	9
CPX-FB33	PROFINET RT, M12	9
CPX-M-FB34	PROFINET RT, RJ45	9
CPX-M-FB35	PROFINET RT, SCRJ	9
CPX-FB36	EtherNet/IP	9
CPX-FB37	EtherCAT	9
CPX-FB38	EtherCAT	9
CPX-FB40	POWERLINK	9
CPX-M-FB41	PROFINET RT	9

1) With Revision 20 (R20)

2) With Revision 23 (R23)

PROFIBUS®, DeviceNet®, CANopen®, INTERBUS®, CC-LINK®, EtherCAT®, PROFINET®, EtherNet/IP® is a registered trademark of its respective trademark holder in certain countries.

# End-position controllers CPX-CMPX

Accessories

**FESTO**

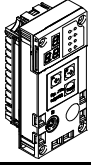
Ordering data – End-position controllers			
	Brief description	Part No.	Type
	Order code in the CPX configurator: T20	548931	CPX-CMPX-C-1-H1

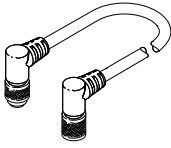
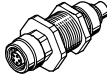
Ordering data – Connecting cables			
	Brief description	Cable length [m]	Part No. Type
	Connecting cable with angled plug and angled socket	0.25	540327 KVI-CP-3-WS-WD-0,25
		0.5	540328 KVI-CP-3-WS-WD-0,5
		2	540329 KVI-CP-3-WS-WD-2
		5	540330 KVI-CP-3-WS-WD-5
		8	540331 KVI-CP-3-WS-WD-8
	Connecting cable with straight plug and straight socket	2	540332 KVI-CP-3-GS-GD-2
5		540333 KVI-CP-3-GS-GD-5	
8		540334 KVI-CP-3-GS-GD-8	
	Connector for control cabinet through-feed	–	543252 KVI-CP-3-SSD

Ordering data – Screws			
	Brief description	Part No.	Type
	For mounting on the metal interlinking block	550219	CPX-M-M3X22-4X

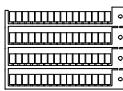
Ordering data – Inscription labels			
	Brief description	Number	Part No. Type
	Inscription labels 6x10, in frames	64	18576 IBS-6X10

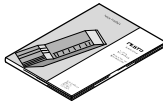
Documentation <sup>1)</sup>			
	Language	Part No.	Type
	DE	555479	P.BE-CPX-CMPX-SYS-DE
	EN	555480	P.BE-CPX-CMPX-SYS-EN
	ES	555481	P.BE-CPX-CMPX-SYS-ES
	FR	555482	P.BE-CPX-CMPX-SYS-FR
	IT	555483	P.BE-CPX-CMPX-SYS-IT
	SV	555484	P.BE-CPX-CMPX-SYS-SV

1) Manual in paper form is not included in the scope of delivery

# End-position controllers CPX-CMPX

Accessories

FESTO

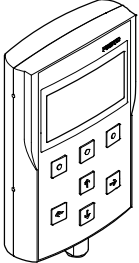
Ordering data – Operator units				
	Brief description	Part No.	Type	
	Commissioning and servicing unit for the CPX terminal	529043	CPX-MMI-1	

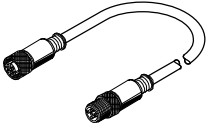
Ordering data – Connecting cables				
	Brief description	Cable length [m]	Part No.	Type
	Connecting cable with straight plug and straight socket, for operator unit CPX-MMI-1	1.5	529044	KV-M12-M12-1,5
		3.5	530901	KV-M12-M12-3,5

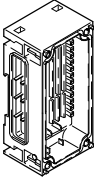
Ordering data – Interlinking block, plastic, as expansion block				
	Brief description	Connection	Part No.	Type
	Without power supply	–	195742	CPX-GE-EV
	With additional power supply for outputs	M18	195744	CPX-GE-EV-Z
		7/8" – 5-pin	541248	CPX-GE-EV-Z-7/8-5POL
		7/8" – 4-pin	541250	CPX-GE-EV-Z-7/8-4POL
	With additional power supply for valves	M18	533577	CPX-GE-EV-V
		7/8" – 4-pin	541252	CPX-GE-EV-V-7/8-4POL

Ordering data – Tie rods				
	Brief description	Extension	Part No.	Type
	For expansion using an interlinking block	1-fold	525418	CPX-ZA-1-E