

Wartungseinheiten MSB-FRC, Baureihe MS

FESTO



Wartungseinheiten MSB-FRC, Baureihe MS

Lieferübersicht Wartungsgeräte Baureihe MS

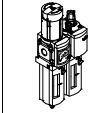
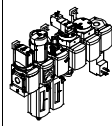
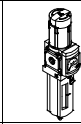
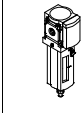
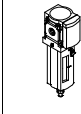
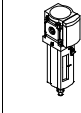
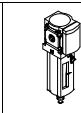
Typ	Bau- größe	Pneumatischer Anschluss im Gehäuse	Anschlussplatte	Druckregelbereich [bar]						Filterfeinheit [µm]				
				0,05 ...	0,05 ...	0,1 ...	0,3 ...	0,1 ...	0,5 ...	0,01	1	5	40	
Code			AG...	D2	D4	D5	D6	D7	D8	A	B	C	E	
Wartungseinheiten														
MSB-FRC 	4	G ¹ / ₈ , G ¹ / ₄	G ¹ / ₈ , G ¹ / ₄ , G ³ / ₈	-	-	-	■	■	-	-	-	■	■	
	6	G ¹ / ₄ , G ³ / ₈ , G ¹ / ₂	G ¹ / ₄ , G ³ / ₈ , G ¹ / ₂ , G ³ / ₄	-	-	-	■	■	-	-	-	■	■	
	9	-												
	12	-												
Wartungsgeräte-Kombinationen (weitere Varianten bestellbar über Konfigurator → Internet: msb4, msb6 oder msb9)														
MSB 	4	G ¹ / ₄	G ¹ / ₈ , G ¹ / ₄ , G ³ / ₈	-	-	-	■	■	-	-	-	■	■	
	6	G ¹ / ₂	G ¹ / ₄ , G ³ / ₈ , G ¹ / ₂ , G ³ / ₄	-	-	-	■	■	-	-	-	■	■	
	9	-												
	12	-												
Einzelgeräte														
Filterregel- ventile MS-LFR 	4	G ¹ / ₈ , G ¹ / ₄	G ¹ / ₈ , G ¹ / ₄ , G ³ / ₈	-	-	■	■	■	-	-	-	■	■	
	6	G ¹ / ₄ , G ³ / ₈ , G ¹ / ₂	G ¹ / ₄ , G ³ / ₈ , G ¹ / ₂ , G ³ / ₄	-	-	■	■	■	■	-	-	■	■	
	9	G ³ / ₄ , G1	G ¹ / ₂ , G ³ / ₄ , G1, G ¹ / ₄ , G ¹ / ₂	-	-	■	■	■	■	-	-	■	■	
	12	-	G1, G ¹ / ₄ , G ¹ / ₂ , G2	-	-	-	■	■	■	-	-	■	■	
Filter MS-LF 	4	G ¹ / ₈ , G ¹ / ₄	G ¹ / ₈ , G ¹ / ₄ , G ³ / ₈	-	-	-	-	-	-	-	-	■	■	
	6	G ¹ / ₄ , G ³ / ₈ , G ¹ / ₂	G ¹ / ₄ , G ³ / ₈ , G ¹ / ₂ , G ³ / ₄	-	-	-	-	-	-	-	-	■	■	
	9	G ³ / ₄ , G1	G ¹ / ₂ , G ³ / ₄ , G1, G ¹ / ₄ , G ¹ / ₂	-	-	-	-	-	-	-	-	■	■	
	12	-	G1, G ¹ / ₄ , G ¹ / ₂ , G2	-	-	-	-	-	-	-	-	■	■	
Fein- und Feinstfilter MS-LFM 	4	G ¹ / ₈ , G ¹ / ₄	G ¹ / ₈ , G ¹ / ₄ , G ³ / ₈	-	-	-	-	-	-	■	■	-	-	
	6	G ¹ / ₄ , G ³ / ₈ , G ¹ / ₂	G ¹ / ₄ , G ³ / ₈ , G ¹ / ₂ , G ³ / ₄	-	-	-	-	-	-	■	■	-	-	
	9	G ³ / ₄ , G1	G ¹ / ₂ , G ³ / ₄ , G1, G ¹ / ₄ , G ¹ / ₂	-	-	-	-	-	-	■	■	-	-	
	12	-	G1, G ¹ / ₄ , G ¹ / ₂ , G2	-	-	-	-	-	-	■	■	-	-	
Aktivkohle- filter MS-LFX 	4	G ¹ / ₈ , G ¹ / ₄	G ¹ / ₈ , G ¹ / ₄ , G ³ / ₈	-	-	-	-	-	-	-	-	-	-	
	6	G ¹ / ₄ , G ³ / ₈ , G ¹ / ₂	G ¹ / ₄ , G ³ / ₈ , G ¹ / ₂ , G ³ / ₄	-	-	-	-	-	-	-	-	-	-	
	9	G ³ / ₄ , G1	G ¹ / ₂ , G ³ / ₄ , G1, G ¹ / ₄ , G ¹ / ₂	-	-	-	-	-	-	-	-	-	-	
	12	-	G1, G ¹ / ₄ , G ¹ / ₂ , G2	-	-	-	-	-	-	-	-	-	-	
Wasser- abscheider MS-LWS 	4	-												
	6	G ¹ / ₄ , G ³ / ₈ , G ¹ / ₂	G ¹ / ₄ , G ³ / ₈ , G ¹ / ₂ , G ³ / ₄	-	-	-	-	-	-	-	-	-	-	
	9	G ³ / ₄ , G1	G ¹ / ₂ , G ³ / ₄ , G1, G ¹ / ₄ , G ¹ / ₂	-	-	-	-	-	-	-	-	-	-	
	12	-	G1, G ¹ / ₄ , G ¹ / ₂ , G2	-	-	-	-	-	-	-	-	-	-	

Wartungseinheiten MSB-FRC, Baureihe MS











Lieferübersicht Wartungsgeräte Baureihe MS

Typ	Bau- größe	Schalen- schutz		Kondensatablass				Druckanzeige					Abschließ- barkeit		Optionen		→ Seite/ Internet	
		Kunststoffschutzkorb	Metallschale	manuell drehend	halbautomatisch	vollautomatisch	extern, vollautoma- tisch, elektrisch	Verschlussblende (ohne Manometer)	integriertes MS-Manometer	Adapter EN-Manometer G1/8	Adapter EN-Manometer G1/4	Drucksensor	Drehknopf mit Arretie- rung, mit Zubehör abschließbar	Drehknopf mit inte- griertem Schloss	Schalldämpfer	Durchflussrichtung von rechts nach links		
Code		R	U	M	H	V	E...	VS	AG	A8	A4	AD...	AS	E11	S	Z		
Wartungseinheiten																		
MSB-FRC	4	■	-	■	-	■	-	-	■	-	-	-	■	-	-	■	8	
	6	■	■	■	-	■	-	-	■	-	-	-	■	-	-	■	8	
	9	-	-	-	-	-	-	-	-	-	-	-	-	-	-	-	-	
	12	-	-	-	-	-	-	-	-	-	-	-	-	-	-	-	-	
Wartungsgeräte-Kombinationen																		
MSB	4	■	■	■	-	■	-	-	■	-	-	-	■	-	-	■	msb4	
	6	■	■	■	-	■	-	-	■	-	-	-	■	-	-	■	msb6	
	9	-	-	-	-	-	-	-	-	-	-	-	-	-	-	-	-	
	12	-	-	-	-	-	-	-	-	-	-	-	-	-	-	-	-	
Einzelgeräte																		
Filterregel- ventile	4	■	■	■	■	■	-	■	■	■	■	■	■	■	■	-	■	ms4-lfr
	6	■	■	■	■	■	■	■	■	■	■	■	■	■	■	-	■	ms6-lfr
MS-LFR	9	-	■	■	■	■	■	■	■	■	■	■	■	■	■	-	■	ms9-lfr
	12	-	■	■	-	■	■	■	■	■	-	■	-	■	■	-	■	ms12-lfr
Filter MS-LF	4	■	■	■	■	■	-	-	-	-	-	-	-	-	-	■	ms4-lf	
	6	■	■	■	■	■	■	-	-	-	-	-	-	-	-	■	ms6-lf	
	9	-	■	■	■	■	■	-	-	-	-	-	-	-	-	■	ms9-lf	
	12	-	■	■	-	■	■	-	-	-	-	-	-	-	-	■	ms12-lf	
Fein- und Feinstfilter MS-LFM	4	■	■	■	■	■	-	-	-	-	-	-	-	-	-	■	ms4-lfm	
	6	■	■	■	■	■	■	-	-	-	-	-	-	-	-	■	ms6-lfm	
	9	-	■	■	■	■	■	-	-	-	-	-	-	-	-	■	ms9-lfm	
	12	-	■	■	-	■	■	-	-	-	-	-	-	-	-	■	ms12-lfm	
Aktivkohle- filter MS-LFX	4	■	■	-	-	-	-	-	-	-	-	-	-	-	-	■	ms4-lfx	
	6	■	■	-	-	-	-	-	-	-	-	-	-	-	-	■	ms6-lfx	
	9	-	■	-	-	-	-	-	-	-	-	-	-	-	-	■	ms9-lfx	
	12	-	■	-	-	-	-	-	-	-	-	-	-	-	-	■	ms12-lfx	
Wasser- abscheider MS-LWS	4	-	-	-	-	-	-	-	-	-	-	-	-	-	-	-	-	
	6	-	■	-	-	■	■	-	-	-	-	-	-	-	-	■	ms6-lws	
	9	-	■	-	-	■	■	-	-	-	-	-	-	-	-	■	ms9-lws	
	12	-	■	-	-	■	■	-	-	-	-	-	-	-	-	■	ms12-lws	

Wartungseinheiten MSB-FRC, Baureihe MS

Lieferübersicht Wartungsgeräte Baureihe MS

FESTO

Typ	Bau- größe	Pneumatischer Anschluss im Gehäuse	Anschlussplatte	Druckregelbereich [bar]							Versorgungsspannung			
				0,05 ...	0,05 ...	0,1 ...	0,3 ...	0,1 ...	0,5 ...	24 V DC, Anschlussbild nach EN 175301	24 V DC, Anschluss M12 nach IEC 61076-2-101	110 V AC, Anschlussbild nach EN 175301	230 V AC, Anschlussbild nach EN 175301	
Code			AG...	D2	D4	D5	D6	D7	D8	V24	V24P	V110	V230	
Einzelgeräte														
Druckregel- ventile MS-LR		4	G1/8, G1/4	G1/8, G1/4, G3/8	-	-	■	■	■	-	-	-	-	
		6	G1/4, G3/8, G1/2	G1/4, G3/8, G1/2, G3/4	-	-	■	■	■	■	-	-	-	-
		9	G3/4, G1	G1/2, G3/4, G1, G1 1/4, G1 1/2	-	-	■	■	■	■	-	-	-	-
		12	-	G1, G1 1/4, G1 1/2, G2	-	-	-	■	■	■	-	-	-	-
Druckregel- ventile MS-LRB		4	G1/4	G1/8, G1/4, G3/8	-	-	■	■	■	-	-	-	-	
		6	G1/2	G1/4, G3/8, G1/2, G3/4	-	-	■	■	■	■	-	-	-	
		9	-	-	-	-	-	-	-	-	-	-	-	
		12	-	-	-	-	-	-	-	-	-	-	-	
Präzisions- Druckregel- ventile MS-LRP		4	-	-	-	-	-	-	-	-	-	-	-	
		6	G1/4, G3/8, G1/2	G1/4, G3/8, G1/2, G3/4	■	■	■	-	■	-	-	-	-	
		9	-	-	-	-	-	-	-	-	-	-	-	
		12	-	-	-	-	-	-	-	-	-	-	-	
Präzisions- Druckregel- ventile MS-LRPB		4	-	-	-	-	-	-	-	-	-	-	-	
		6	G1/2	G1/4, G3/8, G1/2, G3/4	■	■	■	-	■	-	-	-	-	
		9	-	-	-	-	-	-	-	-	-	-	-	
		12	-	-	-	-	-	-	-	-	-	-	-	
Elektrik-Druck- regelventile MS-LRE		4	-	-	-	-	-	-	-	-	-	-	-	
		6	G1/4, G3/8, G1/2	G1/4, G3/8, G1/2, G3/4	-	-	■	■	■	■	-	-	-	
		9	-	-	-	-	-	-	-	-	-	-	-	
		12	-	-	-	-	-	-	-	-	-	-	-	
Öler MS-LOE		4	G1/8, G1/4	G1/8, G1/4, G3/8	-	-	-	-	-	-	-	-	-	
		6	G1/4, G3/8, G1/2	G1/4, G3/8, G1/2, G3/4	-	-	-	-	-	-	-	-	-	
		9	G3/4, G1	G1/2, G3/4, G1, G1 1/4, G1 1/2	-	-	-	-	-	-	-	-	-	
		12	-	G1, G1 1/4, G1 1/2, G2	-	-	-	-	-	-	-	-	-	
Einschalt- ventile MS-EM(1)		4	G1/8, G1/4	G1/8, G1/4, G3/8	-	-	-	-	-	-	-	-	-	
		6	G1/4, G3/8, G1/2	G1/4, G3/8, G1/2, G3/4	-	-	-	-	-	-	-	-	-	
		9	G3/4, G1	G1/2, G3/4, G1, G1 1/4, G1 1/2	-	-	-	-	-	-	-	-	-	
		12	-	G1, G1 1/4, G1 1/2, G2	-	-	-	-	-	-	-	-	-	
Einschalt- ventile MS-EE		4	G1/8, G1/4	G1/8, G1/4, G3/8	-	-	-	-	-	■	-	■	■	
		6	G1/4, G3/8, G1/2	G1/4, G3/8, G1/2, G3/4	-	-	-	-	-	■	-	■	■	
		9	G3/4, G1	G1/2, G3/4, G1, G1 1/4, G1 1/2	-	-	-	-	-	■	■	■	■	
		12	-	G1, G1 1/4, G1 1/2, G2	-	-	-	-	-	■	■	■	■	
Druckaufbau- ventile MS-DL		4	G1/8, G1/4	G1/8, G1/4, G3/8	-	-	-	-	-	-	-	-	-	
		6	G1/4, G3/8, G1/2	G1/4, G3/8, G1/2, G3/4	-	-	-	-	-	-	-	-	-	
		9	-	-	-	-	-	-	-	-	-	-	-	
		12	-	G1, G1 1/4, G1 1/2, G2	-	-	-	-	-	-	-	-	-	
Druckaufbau- ventile MS-DE		4	G1/8, G1/4	G1/8, G1/4, G3/8	-	-	-	-	-	■	-	■	■	
		6	G1/4, G3/8, G1/2	G1/4, G3/8, G1/2, G3/4	-	-	-	-	-	■	-	■	■	
		9	-	-	-	-	-	-	-	-	-	-	-	
		12	-	G1, G1 1/4, G1 1/2, G2	-	-	-	-	-	-	■	■	■	

Wartungseinheiten MSB-FRC, Baureihe MS





Lieferübersicht Wartungsgeräte Baureihe MS

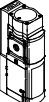

Typ	Bau- größe	Schalenschutz		Druckanzeige				Abschließbar- keit			Optionen		→ Seite/ Internet
		Kunststoffschutzkorb	Metallschale	Verschlussblende (ohne Manometer)	integriertes MS-Manometer	Adapter EN-Manometer G1/8	Adapter EN-Manometer G1/4	Drucksensor	Drehknopf mit Arretie- rung, mit Zubehör abschließbar	Drehknopf mit inte- griertem Schloss	Schalldämpfer	Durchflussrichtung von rechts nach links	
Code		R	U	VS	AG	A8	A4	AD...	AS	E11	S	Z	
Einzelgeräte													
Druckregel- ventile MS-LR	4	-	-	■	■	■	■	■	■	■	-	■	ms4-lr
	6	-	-	■	■	-	■	■	■	■	-	■	ms6-lr
	9	-	-	■	■	-	■	■	■	■	-	■	ms9-lr
	12	-	-	■	■	-	■	-	■	■	-	■	ms12-lr
Druckregel- ventile MS-LRB	4	-	-	■	■	■	■	■	■	■	-	■	ms4-lrb
	6	-	-	■	■	-	■	■	■	■	-	■	ms6-lrb
	9	-	-	-	-	-	-	-	-	-	-	-	-
	12	-	-	-	-	-	-	-	-	-	-	-	-
Präzisions- Druckregel- ventile MS-LRP	4	-	-	■	-	■	■	■	■	■	-	■	ms6-lrp
	6	-	-	■	-	■	■	■	■	■	-	■	ms6-lrp
	9	-	-	-	-	-	-	-	-	-	-	-	-
	12	-	-	-	-	-	-	-	-	-	-	-	-
Präzisions- Druckregel- ventile MS-LRPB	4	-	-	■	-	■	■	■	■	■	-	■	ms6-lrpb
	6	-	-	■	-	■	■	■	■	■	-	■	ms6-lrpb
	9	-	-	-	-	-	-	-	-	-	-	-	-
	12	-	-	-	-	-	-	-	-	-	-	-	-
Elektrik-Druck- regelventile MS-LRE	4	-	-	■	■	-	■	-	-	-	-	■	ms6-lre
	6	-	-	■	■	-	■	-	-	-	-	■	ms6-lre
	9	-	-	-	-	-	-	-	-	-	-	-	-
	12	-	-	-	-	-	-	-	-	-	-	-	-
Öler MS-LOE	4	■	■	-	-	-	-	-	-	-	-	■	ms4-loe
	6	■	■	-	-	-	-	-	-	-	-	■	ms6-loe
	9	-	■	-	-	-	-	-	-	-	-	■	ms9-loe
	12	-	■	-	-	-	-	-	-	-	-	■	ms12-loe
Einschalt- ventile MS-EM(1)	4	-	-	■	■	■	■	■	-	-	■	■	ms4-em1
	6	-	-	■	■	-	■	■	-	-	■	■	ms6-em1
	9	-	-	■	■	-	■	-	-	-	■	■	ms9-em
	12	-	-	■	■	-	■	-	-	-	■	■	ms12-em
Einschalt- ventile MS-EE	4	-	-	■	■	■	■	■	-	-	■	■	ms4-ee
	6	-	-	■	■	-	■	■	-	-	■	■	ms6-ee
	9	-	-	■	■	-	■	-	-	-	■	■	ms9-ee
	12	-	-	■	■	-	■	-	-	-	■	■	ms12-ee
Druckaufbau- ventile MS-DL	4	-	-	■	■	■	■	■	-	-	-	■	ms4-dl
	6	-	-	■	■	-	■	■	-	-	-	■	ms6-dl
	9	-	-	-	-	-	-	-	-	-	-	-	-
	12	-	-	■	■	-	■	-	-	-	-	■	ms12-dl
Druckaufbau- ventile MS-DE	4	-	-	■	■	■	■	■	-	-	-	■	ms4-de
	6	-	-	■	■	-	■	■	-	-	-	■	ms6-de
	9	-	-	-	-	-	-	-	-	-	-	-	-
	12	-	-	■	■	-	■	-	-	-	-	■	ms12-de

Wartungseinheiten MSB-FRC, Baureihe MS

Lieferübersicht Wartungsgeräte Baureihe MS

Typ	Bau- größe	Pneumatischer Anschluss im Gehäuse	Anschlussplatte	Performance Level		Versorgungsspannung				
				Kategorie 1, 1-Kanal	Kategorie 4, 2-Kanal mit Selbstüberwachung	24 V DC, Anschlussbild nach EN 175301	24 V DC, Anschluss M12 nach IEC 61076-2-101/ nach EN 60947-5-2	110 V AC, Anschlussbild nach EN 175301	230 V AC, Anschlussbild nach EN 175301	
Code			AG...	C	E	V24	V24P	V110	V230	
Einzelgeräte										
Druckaufbau- und Entlüf- tungsventile MS-SV-C		4	–							
		6	G1/2	G1/4, G3/8, G1/2, G3/4	■	–	■	■	■	■
		9	G3/4, G1	G1/2, G3/4, G1, G11/4, G11/2	■	–	■	■	■	■
		12	–							
Druckaufbau- und Entlüf- tungsventile MS-SV-E		4	–							
		6	G1/2	G1/4, G3/8, G1/2, G3/4	–	■	■	–	–	–
		9	–							
		12	–							
Membran- Lufttrockner MS-LDM1		4	G1/8, G1/4	G1/8, G1/4, G3/8	–	–	–	–	–	
		6	G1/4, G3/8, G1/2	G1/4, G3/8, G1/2, G3/4	–	–	–	–	–	
		9	–							
		12	–							
Abzweig- module MS-FRM		4	G1/8, G1/4	G1/8, G1/4, G3/8	–	–	–	–	–	
		6	G1/4, G3/8, G1/2	G1/4, G3/8, G1/2, G3/4	–	–	–	–	–	
		9	G3/4, G1	G1/2, G3/4, G1, G11/4, G11/2	–	–	–	–	–	
		12	–	G1, G11/4, G11/2, G2	–	–	–	–	–	
Verteiler- blöcke MS-FRM-FRZ		4	G1/4	–	–	–	–	–	–	
		6	G1/2	–	–	–	–	–	–	
		9	–							
		12	–							
Durchfluss- sensoren SFAM		4	–							
		6	G1/2	G1/2	–	–	–	–	–	
		9	–	G1, G11/2	–	–	–	–	–	
		12	–							

Wartungseinheiten MSB-FRC, Baureihe MS

Lieferübersicht Wartungsgeräte Baureihe MS

Typ	Bau- größe	Schalenschutz		Druckanzeige					Schaltausgang			Optionen		→ Seite/ Internet
		Kunststoffschutzkorb	Metallschale	Verschlussblende (ohne Manometer)	integriertes MS-Manometer	Adapter EN-Manometer G1/8	Adapter EN-Manometer G1/4	Drucksensor	2x PNP oder NPN, 1 Analogausgang 4 ... 20 mA	2x PNP oder NPN, 1 Analogausgang 0 ... 10 V	Schalldämpfer	Durchflussrichtung von rechts nach links		
Code		R	U	VS	AG	A8	A4	AD...	2SA	2SV	S	Z/R		
Einzelgeräte														
Druckaufbau- und Entlüf- tungsventile MS-SV-C	4	-												-
	6	-	-	■	■	-	■	■	-	-	■	■	ms6-sv	
	9	-	-	■	■	-	■	■	-	-	■	■	ms9-sv	
	12	-											-	
Druckaufbau- und Entlüf- tungsventile MS-SV-E	4	-											-	
	6	-	-	■	■	-	■	■	-	-	■	■	ms6-sv	
	9	-											-	
	12	-											-	
Membran- Lufttrockner MS-LDM1	4	-	■	-	-	-	-	-	-	-	-	■	ms4-ldm1	
	6	-	■	-	-	-	-	-	-	-	-	■	ms6-ldm1	
	9	-											-	
	12	-											-	
Abzweig- module MS-FRM	4	-	-	■	■	■	■	■	-	-	-	■	ms4-frm	
	6	-	-	■	■	-	■	■	-	-	-	■	ms6-frm	
	9	-	-	■	■	-	■	■	-	-	-	■	ms9-frm	
	12	-	-	■	-	-	-	-	-	-	-	-	ms12-frm	
Verteiler- blöcke MS-FRM-FRZ	4	-	-	-	-	-	-	-	-	-	-	■	ms4-frm	
	6	-	-	-	-	-	-	-	-	-	-	■	ms6-frm	
	9	-											-	
	12	-											-	
Durchfluss- sensoren SFAM	4	-											-	
	6	-	-	-	-	-	-	-	■	■	-	■	sfam-62	
	9	-	-	-	-	-	-	-	■	■	-	■	sfam-90	
	12	-											-	

Wartungseinheiten MSB4/MSB6-FRC, Baureihe MS

Peripherieübersicht

FESTO

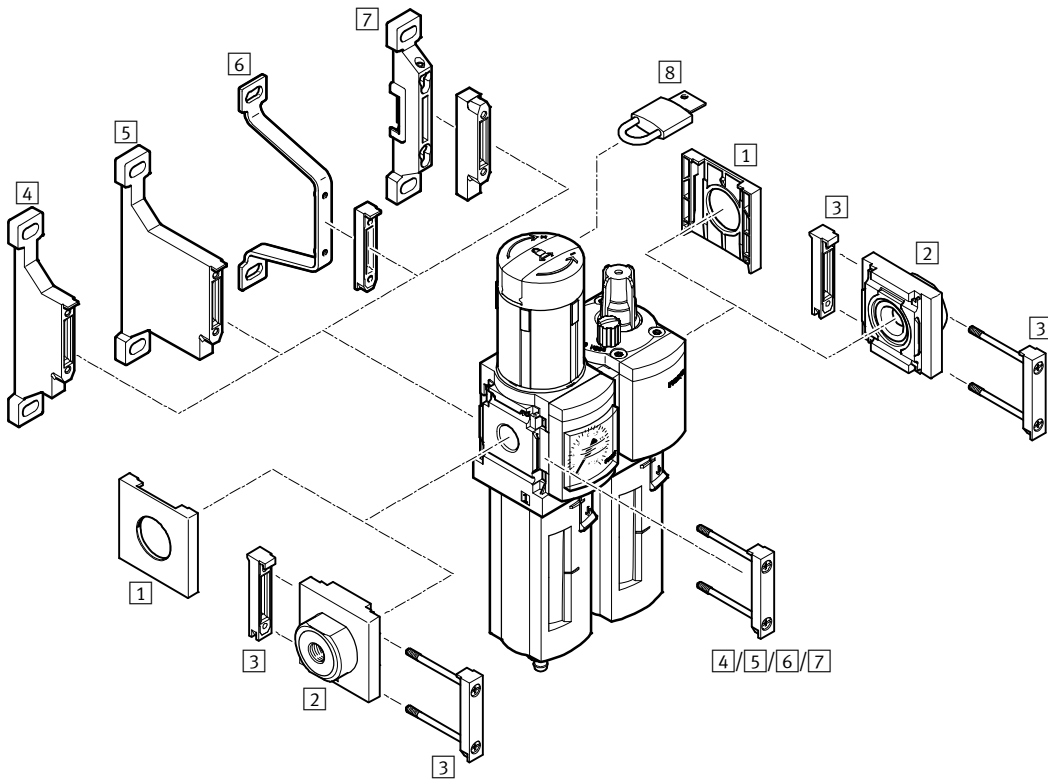

Befestigungselemente und Zubehör		→ Seite/Internet
1	Abdeckkappe MS4/6-END	ms4-end, ms6-end
2	Anschlussplatte-SET MS4/6-AG...	ms4-ag, ms6-ag
3	Modulverbinder MS4/6-MV	ms4-mv, ms6-mv
4	Befestigungswinkel MS4/6-WP	ms4-wp, ms6-wp
5	Befestigungswinkel MS4/6-WPB	ms4-wp, ms6-wp
6	Befestigungswinkel MS4/6-WPE	ms4-wp, ms6-wp
7	Befestigungswinkel MS4/6-WPM	ms4-wp, ms6-wp
8	Bügelverschluss LRVS-D	16

Wartungseinheiten MSB4/MSB6-FRC, Baureihe MS

Typenschlüssel

MSB 6 - 3/8 - FRC5:J1 M1

Baureihe

MSB	Wartungseinheit
-----	-----------------

Baugröße

4	Rastermaß 40 mm
6	Rastermaß 62 mm

Pneumatischer Anschluss

MSB4	
1/8	Gewinde G1/8
1/4	Gewinde G1/4
MSB6	
1/4	Gewinde G1/4
3/8	Gewinde G3/8
1/2	Gewinde G1/2

Wartungseinheit bestehend aus:

- Filterregelventil mit Manometer, Drehknopf mit Arretierung, mit Zubehör schließbar
- Öler

Druckregelbereich 0,3 ... 7 bar

Kunststoffschutzkorb	
FRC1:J5	Filterfeinheit 40 µm, Kondensatablass manuell drehend

Druckregelbereich 0,5 ... 12 bar

Kunststoffschutzkorb	
FRC7:J3	Filterfeinheit 5 µm, Kondensatablass manuell drehend
FRC5:J1	Filterfeinheit 40 µm, Kondensatablass manuell drehend
FRC6:J2	Filterfeinheit 40 µm, Kondensatablass vollautomatisch

Metallschale

FRC11:J9	Filterfeinheit 5 µm, Kondensatablass manuell drehend
FRC12:J10	Filterfeinheit 5 µm, Kondensatablass vollautomatisch
FRC9:J11	Filterfeinheit 40 µm, Kondensatablass manuell drehend
FRC10:J12	Filterfeinheit 40 µm, Kondensatablass vollautomatisch

Öler

M1	Kunststoffschutzkorb
M2	Metallschale

Wartungseinheiten MSB4/MSB6-FRC, Baureihe MS

FESTO

Datenblatt

mit Kondensatablass
manuell drehend

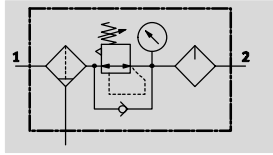

vollautomatisch

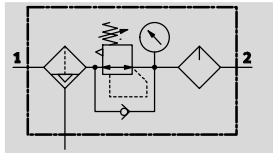

- - Durchfluss
850 ... 4 800 l/min
- - Temperaturbereich
-10 ... +60 °C
- - Betriebsdruck
1,5 ... 20 bar



- Filter-, Regler- und Ölerfunktion in einer Geräteeinheit
- Hoher Durchfluss und Wirkungsgrad der Schmutzabscheidung
- Gute Regelcharakteristik mit kleiner Druck-Hysterese
- Sicherung der Einstellwerte durch Arretierung des Drehknopfes
- Abschließbarer Drehknopf
- Zwei Druckregelbereiche: 0,3 ... 7 bar und 0,5 ... 12 bar
- Wahlweise mit manuellem oder integriertem, vollautomatischem Kondensatablass
- Wahlweise Filtereinsätze 5 µm oder 40 µm
- Neue Filterpatronen → 16, Festo Spezialöl → 16

Allgemeine Technische Daten		
Baugröße	MSB4	MSB6
Pneumatischer Anschluss 1, 2	G $\frac{3}{8}$	-
	G $\frac{1}{4}$	G $\frac{1}{4}$
	-	G $\frac{3}{8}$
	-	G $\frac{1}{2}$
Konstruktiver Aufbau	Filterregler mit Manometer	
	Proportional-Standardnebelöler	
Reglerfunktion	Ausgangsdruck konstant, mit Vordruckkompensation, mit Rückstromverhalten, mit Sekundärentlüftung	
Befestigungsart	mit Zubehör	
Einbaulage	senkrecht ±5°	
Filterfeinheit [µm]	5	
	40	
Luftreinheitsklasse am Ausgang	Druckluft nach ISO 8573-1:2010 [6:4:-] (Filterfeinheit 5 µm)	
	Druckluft nach ISO 8573-1:2010 [7:4:-] (Filterfeinheit 40 µm)	
Schalenschutz	Kunststoffschutzkorb	Kunststoffschutzkorb
	-	integriert als Metallschale
Kondensatablass	manuell drehend	
	vollautomatisch	
Betätigungssicherung	Drehknopf mit Arretierung, mit Zubehör schließbar	
Druckregelbereich [bar]	0,3 ... 7	
	0,5 ... 12	
Druckanzeige	mit Manometer	

• Hinweis: Dieses Produkt entspricht ISO 1179-1 und ISO 228-1.

Wartungseinheiten MSB4/MSB6-FRC, Baureihe MS

Datenblatt

Normalnennendurchfluss $q_{nN}^{1)}$ [l/min]						
Baugröße	MSB4			MSB6		
Pneumatischer Anschluss	G $\frac{1}{8}$	G $\frac{1}{4}$	G $\frac{1}{4}$	G $\frac{3}{8}$	G $\frac{1}{2}$	
Druckregelbereich 0,3 ... 7 bar						
Filterfeinheit	40 μ m	–	1 400	–	–	4 800
Druckregelbereich 0,5 ... 12 bar						
Filterfeinheit	5 μ m	–	850	–	–	3 600
	40 μ m	850	900	1 900	3 500	3 700

1) Gemessen bei $p_1 = 10$ bar und $p_2 = 6$ bar, $\Delta p = 1$ bar.

Betriebs- und Umweltbedingungen				
Kondensatablass	manuell drehend		vollautomatisch	
Baugröße	MSB4	MSB6	MSB4	MSB6
Betriebsdruck [bar]	1,5 ... 14	1,5 ... 20	2 ... 12	2 ... 12
Betriebsmedium	Druckluft nach ISO 8573-1:2010 [–:4:–]		Druckluft nach ISO 8573-1:2010 [7:4:–]	
	Inerte Gase			
Hinweis zum Betriebs-/ Steuermedium	Geölter Betrieb möglich (im weiteren Betrieb erforderlich)			
Umgebungstemperatur [°C]	–10 ... +60		+5 ... +60	
Mediumtemperatur [°C]	–10 ... +60		+5 ... +60	
Lagertemperatur [°C]	–10 ... +60		–10 ... +60	
Korrosionsbeständigkeit KBK ¹⁾	2			

1) Korrosionsbeständigkeitsklasse KBK 2 nach Festo Norm FN 940070
Mäßige Korrosionsbeanspruchung. Innenraumanwendung bei der Kondensation auftreten darf. Außenliegende sichtbare Teile mit vorrangig dekorativer Anforderung an die Oberfläche, die in direktem Kontakt zur umgebenden industrietypischen Atmosphäre stehen.

Gewichte [g]		
Baugröße	MSB4	MSB6
mit Kunststoffschutzkorb	500	1 495
mit Metallschale	–	1 713

Werkstoffe

Funktionsschnitt

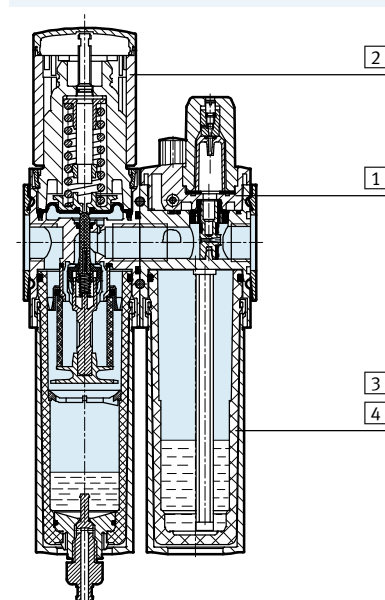

Wartungseinheit		
1	Gehäuse	Aluminium-Druckguss
2	Drehknopf	PA/POM
3	Kunststoffschutzkorb	PC
4	Metallschale	Aluminium-Knetlegierung
–	Dichtungen	NBR

Wartungseinheiten MSB4/MSB6-FRC, Baureihe MS

Datenblatt

Normaldurchfluss q_n in Abhängigkeit vom Ausgangsdruck p_2

Druckregelbereich 0,3 ... 7 bar

Filterfeinheit 5 μm

Filterfeinheit 40 μm

MSB4- $\frac{1}{4}$

Primärdruck $p_1 = 10$ bar

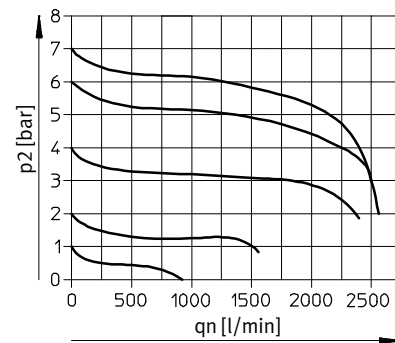

Druckregelbereich 0,5 ... 12 bar

Filterfeinheit 5 μm

Filterfeinheit 40 μm

MSB4- $\frac{1}{8}$

Primärdruck $p_1 = 10$ bar

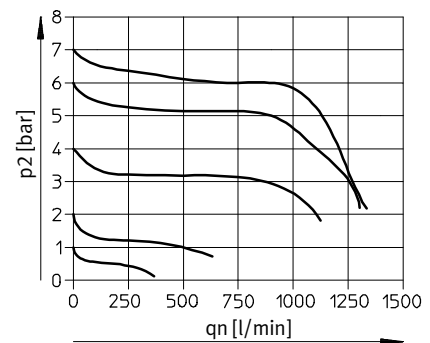

MSB4- $\frac{1}{4}$

Primärdruck $p_1 = 10$ bar

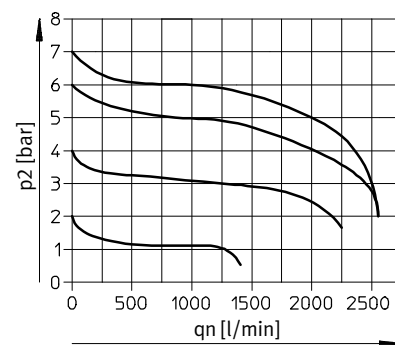
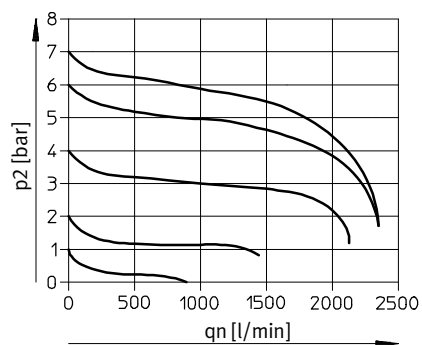

Wartungseinheiten MSB4/MSB6-FRC, Baureihe MS

Datenblatt

Normaldurchfluss q_n in Abhängigkeit vom Ausgangsdruck p_2

Druckregelbereich 0,3 ... 7 bar

Filterfeinheit 5 μm

Filterfeinheit 40 μm

MSB6-1/2

Primärdruck $p_1 = 10$ bar

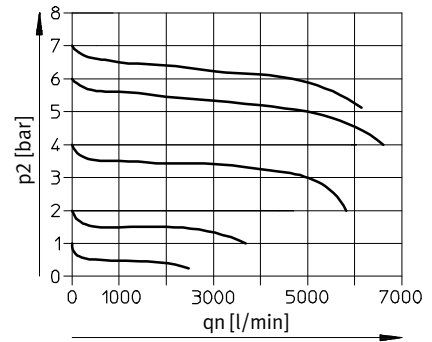

Druckregelbereich 0,5 ... 12 bar

Filterfeinheit 5 μm

Filterfeinheit 40 μm

MSB6-1/4

Primärdruck $p_1 = 10$ bar

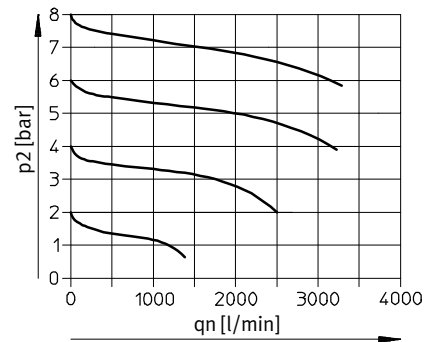

MSB6-3/8

Primärdruck $p_1 = 10$ bar

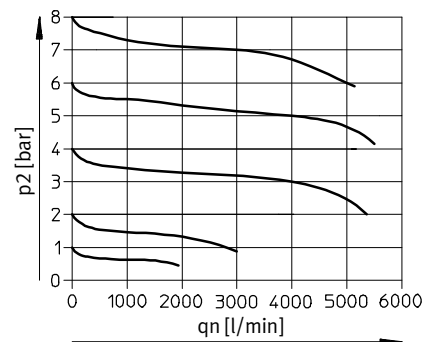

MSB6-1/2

Primärdruck $p_1 = 10$ bar

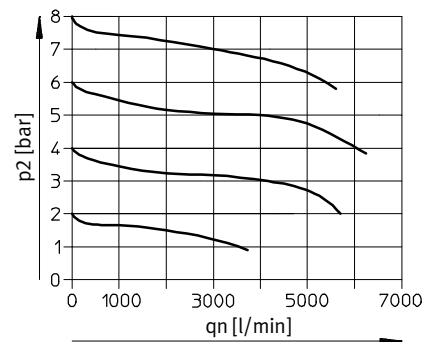
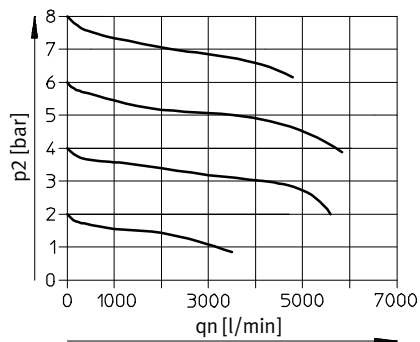

Wartungseinheiten MSB4/MSB6-FRC, Baureihe MS

Datenblatt

Abmessungen

Download CAD-Daten → www.festo.com

mit Manometer, Anzeigeeinheit [bar]

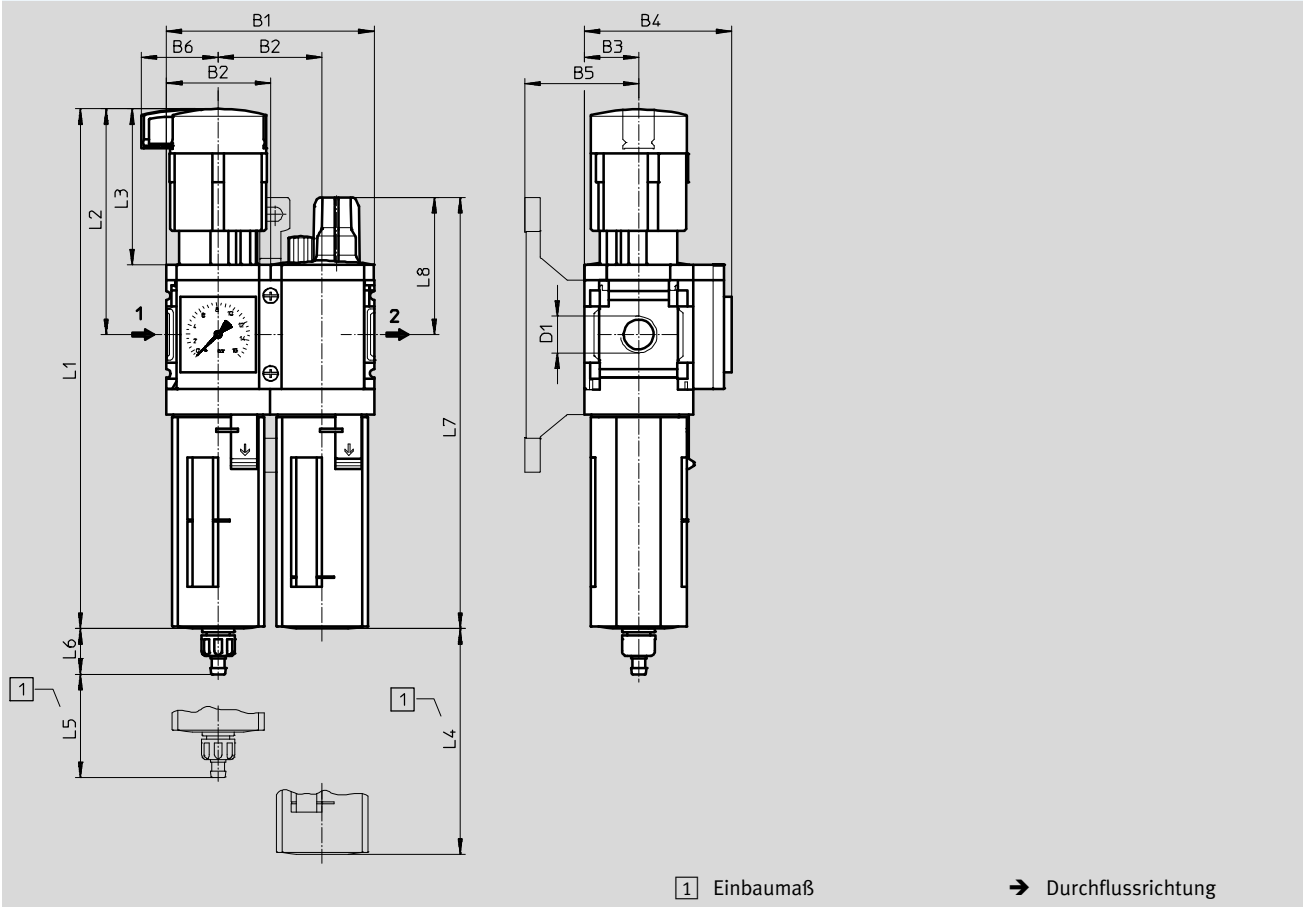

Typ	B1	B2	B3	B4	B5	B6	D1	L1	L2	L3	L4	L5	L6		L7	L8
													manuell drehend	vollauto- matisch		
MSB4-1/8	80,4	40,2	21	57	44	29,7	G1/8	201	87	60	80	25	17,7	20,4	167	53
MSB4-1/4							G1/4									
MSB6-1/4	124	62	31	77	54	38,8	G1/4	284,8	134,5	95,5	130	68	15,8	18,5	215,3	65,6
MSB6-3/8							G3/8									
MSB6-1/2							G1/2									

— Hinweis: Dieses Produkt entspricht ISO 1179-1 und ISO 228-1.

Wartungseinheiten MSB4/MSB6-FRC, Baureihe MS

Datenblatt

Bestellangaben						
Druckregelbereich 0,3 ... 7 bar						
Baugröße	Kondensatablass	Anschluss	Filterfeinheit 5 µm		Filterfeinheit 40 µm	
			Teile-Nr.	Typ	Teile-Nr.	Typ
Kunststoffschutzkorb						
MSB4	manuell drehend	G¼	-	-	531109	MSB4-¼-FRC1:J5M1
MSB6	manuell drehend	G½	-	-	530230	MSB6-½-FRC1:J5M1

Bestellangaben						
Druckregelbereich 0,5 ... 12 bar						
Baugröße	Kondensatablass	Anschluss	Filterfeinheit 5 µm		Filterfeinheit 40 µm	
			Teile-Nr.	Typ	Teile-Nr.	Typ
Kunststoffschutzkorb						
MSB4	manuell drehend	G⅛	-	-	531133	MSB4-⅛-FRC5:J1M1
		G¼	531121	MSB4-¼-FRC7:J3M1	531117	MSB4-¼-FRC5:J1M1
	vollautomatisch	G¼	-	-	531119	MSB4-¼-FRC6:J2M1
MSB6	manuell drehend	G¼	-	-	530268	MSB6-¼-FRC5:J1M1
		G¾	-	-	530292	MSB6-¾-FRC5:J1M1
		G½	530248	MSB6-½-FRC7:J3M1	530244	MSB6-½-FRC5:J1M1
	vollautomatisch	G½	-	-	530246	MSB6-½-FRC6:J2M1
Metallschale						
MSB6	manuell drehend	G½	530234	MSB6-½-FRC11:J9M2	530252	MSB6-½-FRC9:J11M2
	vollautomatisch	G½	530236	MSB6-½-FRC12:J10M2	530232	MSB6-½-FRC10:J12M2

Wartungseinheiten MSB-FRC, Baureihe MS

Zubehör

Filterpatronen



Bestellangaben			
Baugröße	Filterfeinheit [µm]	Teile-Nr.	Typ
MS4	5 (Farbe: blau)	534501	MS4-LFP-C
	40 (Farbe: weiß)	534502	MS4-LFP-E
MS6	5 (Farbe: blau)	534499	MS6-LFP-C
	40 (Farbe: weiß)	534500	MS6-LFP-E

Spezialöl



Bestellangaben			
Lieferumfang		Teile-Nr.	Typ
1 Liter		152811	OFSW-32

Bestellangaben – Bügelschloss LRVS-D			
	Gewicht [g]	Teile-Nr.	Typ
	120	193786	LRVS-D